



User Guide

© Copyright 2020 HP Development Company, L.P.

FreeSync is a trademark of Advanced Micro Devices, Inc. HDMI, the HDMI Logo and High-Definition Multimedia Interface are trademarks or registered trademarks of HDMI Licensing LLC. Windows is either a registered trademark or trademark of Microsoft Corporation in the United States and/or other countries. VESA® is a trademark or registered trademark owned by the Video Electronics Standards Association (VESA) in the United States and other countries.

The information contained herein is subject to change without notice. The only warranties for HP products and services are set forth in the express warranty statements accompanying such products and services. Nothing herein should be construed as constituting an additional warranty. HP shall not be liable for technical or editorial errors or omissions contained herein.

Product notice





This guide describes features that are common to most models. Some features may not be available on your product. To access the latest user guide, go to <http://www.hp.com/support>, and follow the instructions to find your product. Then select **User Guides**.

First Edition: May 2020

Document Part Number: L97901-001

About this guide

This guide provides technical specifications and information about monitor features, setting up the monitor, and using the software. Depending on the model, your monitor may not have all the features included in this guide.

-
-  **WARNING!** Indicates a hazardous situation that, if not avoided, **could** result in serious injury or death.
 -  **CAUTION:** Indicates a hazardous situation that, if not avoided, **could** result in minor or moderate injury.
 -  **IMPORTANT:** Indicates information considered important but not hazard-related (for example, messages related to property damage). Warns the user that failure to follow a procedure exactly as described could result in loss of data or in damage to hardware or software. Also contains essential information to explain a concept or to complete a task.
 -  **NOTE:** Contains additional information to emphasize or supplement important points of the main text.
 -  **TIP:** Provides helpful hints for completing a task.
-



This product incorporates HDMI technology.



Table of contents

1 Getting started	1
Important safety information	1
Product features and components	2
Features	2
Front components	3
Rear and side components	4
Setting up the monitor	5
Attaching the monitor stand	5
Mounting the monitor head	6
Removing the monitor stand	6
Attaching the monitor head to a mounting device (select products only)	7
Connecting the cables	8
Adjusting the monitor	10
Installing a security cable	10
Turning on the monitor	11
HP watermark and image retention policy (select products only)	11
2 Using the monitor	12
Downloading software and utilities	12
The Information file	12
The Image Color Matching file	12
Using the OSD menu	13
Using the function buttons	14
Reassigning the function buttons	14
Using Auto-Sleep Mode	14
Adjusting blue light output	15
3 Support and troubleshooting	16
Solving common issues	16
Button lockouts	17
Using the auto-adjustment function (analog input)	17
Optimizing image performance (analog input)	18
Contacting support	19
Preparing to call technical support	19
Locating the serial number and product number	20



4 Maintaining the monitor	21
Maintenance guidelines	21
Cleaning the monitor	21
Shipping the monitor	22
Appendix A Technical specifications	23
68.6 cm (27.0 in) model specifications	23
61.0 cm (24.0 in) model specifications	23
60.5 cm (23.8 in) model specifications	24
54.6 cm (21.5 in) model specifications	25
52.6 cm (20.7 in) model specifications	25
49.5 cm (19.5 in) model specifications	26
47.0 cm (18.5 in) model specifications	26
Preset display resolutions	27
68.6 cm (27.0 in) models	27
61.0 cm (24.0 in) models	28
60.5 cm (23.8 in) models	28
54.6 cm (21.5 in) models	29
52.6 cm (20.7 in) models	29
49.5 cm (19.5 in) models	30
47.0 cm (18.5 in) models	30
Preset timing resolutions	30
Energy saver feature	31
Appendix B Accessibility	32
HP and accessibility	32
Finding the technology tools you need	32
The HP commitment	32
International Association of Accessibility Professionals (IAAP)	32
Finding the best assistive technology	33
Assessing your needs	33
Accessibility for HP products	33
Standards and legislation	34
Standards	34
Mandate 376 – EN 301 549	34
Web Content Accessibility Guidelines (WCAG)	34
Legislation and regulations	34
Useful accessibility resources and links	35
Organizations	35
Educational institutions	35



Other disability resources	35
HP links	35
Contacting support	36





1 Getting started

Important safety information

A power cord is included with the monitor. If you use another cord, use only a power source and connection appropriate for this monitor. For information about the correct power cord set to use with the monitor, see the *Product Notices* provided in your documentation kit.

 **WARNING!** To reduce the risk of electric shock or damage to the equipment:

- Plug the power cord into an AC outlet that is easily accessible at all times.
- If the power cord has a 3-pin attachment plug, plug the cord into a grounded (earthed) 3-pin outlet.
- Disconnect power from the computer by unplugging the power cord from the AC outlet. When unplugging the power cord from the AC outlet, grasp the cord by the plug.

For your safety, do not place anything on power cords or cables. Care should be taken to route all cords and cables connected to the monitor so that they cannot be stepped on, pulled, grabbed, or tripped over.

To reduce the risk of serious injury, read the *Safety & Comfort Guide* provided with your user guides. It describes proper workstation setup and proper posture, health, and work habits for computer users. The *Safety & Comfort Guide* also provides important electrical and mechanical safety information. The *Safety & Comfort Guide* is also available on the Web at <http://www.hp.com/ergo>.

 **IMPORTANT:** For the protection of the monitor and the computer, connect all power cords for the computer and its peripheral devices (such as a monitor, printer, scanner) to a surge protection device such as a power strip or uninterruptible power supply (UPS). Not all power strips provide surge protection; the power strip must be specifically labeled as having this capability. Use a power strip whose manufacturer offers a damage replacement policy so that you can replace the equipment if surge protection fails.

Use the appropriate and correctly sized furniture designed to properly support your monitor.

 **WARNING!** Monitors that are inappropriately situated on dressers, bookcases, shelves, desks, speakers, chests, or carts could fall over and cause personal injury.

 **NOTE:** This product is suitable for entertainment purposes. Consider placing the monitor in a controlled luminous environment to avoid interference from surrounding light and bright surfaces that might cause disturbing reflections from the screen.

Product features and components

Features

Depending on the model, your monitor might include the following features:

- The following models, which include full-screen support for lower resolutions; includes custom scaling for maximum image size while preserving original aspect ratio:
 - 68.6 cm (27.0 in) diagonal viewable screen area with 1920 × 1080 resolution
 - 61.0 cm (24.0 in) diagonal viewable screen area with 1920 × 1080 resolution
 - 60.5 cm (23.8 in) diagonal viewable screen area with 1920 × 1080 resolution
 - 54.6 cm (21.5 in) diagonal viewable screen area with 1920 × 1080 resolution
 - 52.6 cm (20.7 in) diagonal viewable screen area with 1920 × 1080 resolution
 - 49.5 cm (19.5 in) diagonal viewable screen area with 1600 × 900 resolution
 - 47.0 cm (18.5 in) diagonal viewable screen area with 1366 × 768 resolution
- In-plane switching (IPS) or twisted nematic (TN) panel
- Nonglare panel with an LED backlight
- Wide viewing angle on IPS models to allow viewing from a sitting or standing position, or moving from side to side (select products only)
- Tilt adjustment capability
- Removable stand for flexible monitor head mounting solutions
- High-Definition Multimedia Interface™ (HDMI) video input (select products only; cable included in select regions)
- VGA video input (cable included in select regions)
- Audio-in jack (P21 models only)
- Four on-screen display (OSD) buttons, three that you can reconfigure to quickly allow selection of the most commonly used operations
- Plug and Play capability if supported by your operating system
- VESA® mounting bracket for attaching the monitor head to a wall-mount device or swing arm (select products only)
- Security cable slot on the rear of the monitor for an optional security cable
- On-screen adjustments in several languages for easy setup and screen optimization
- Support for FreeSync™, an Adaptive-Sync technology, to reduce stuttering and tearing in games and videos by locking the monitor's refresh rate to the frame rate of a compatible graphics card (select products only).

 **NOTE:** Adaptive refresh rates vary by display.

- Energy saver feature to meet requirements for reduced power consumption

 **NOTE:** For safety and regulatory information, see the *Product Notices* provided in your documentation kit. To access the latest user guide, go to <http://www.hp.com/support>, and follow the instructions to find your product. Then select **Manuals**.

Front components

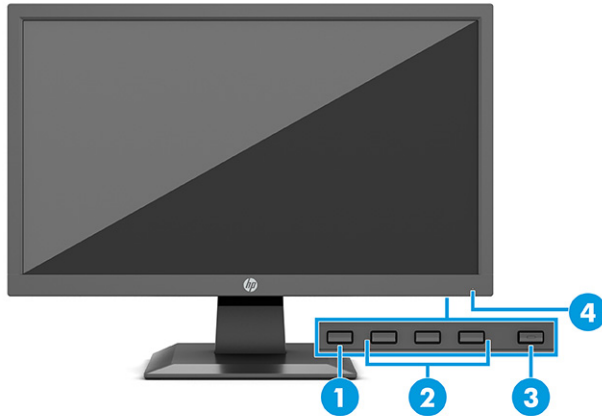

Table 1-1 Front components and their descriptions

Component	Description
(1) Menu button	Press to open the OSD menu and select a menu item from the OSD.
(2) OSD buttons (assignable)	When the OSD menu is open, press the buttons to navigate through the menu. The function light icons indicate the default button functions. For a description of these functions, see Using the function buttons on page 14 . You can reassign the function buttons to quickly select the most commonly used operations. See Reassigning the function buttons on page 14 .
(3) Power button	Turns the monitor on or off.
(4) Power light	White: The monitor is on. Amber: Monitor is in a reduced power state because of inactivity. See Using Auto-Sleep Mode on page 14 .

Rear and side components

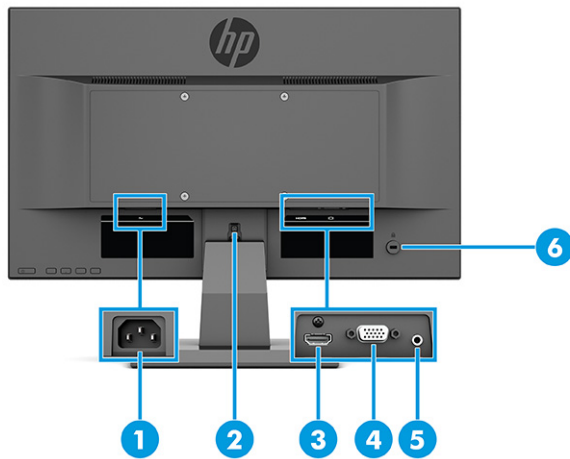

Table 1-2 Rear and side components and their descriptions

Component	Description
(1) Power connector	Connects the power cord.
(2) Stand release button	Releases the stand from the monitor.
(3) HDMI port (select products only)	Connects the HDMI cable to a source device such as a computer or game console.
(4) VGA connector	Connects the VGA cable to the source device.
(5) Audio-in jack (select products only)	Connects the audio cable to the monitor.
(6) Security cable slot	Connects an optional security cable.

Setting up the monitor

⚠ WARNING! To reduce the risk of serious injury, read the *Safety & Comfort Guide*. It describes proper workstation setup and proper posture, health, and work habits for computer users. The *Safety & Comfort Guide* also provides important electrical and mechanical safety information. The *Safety & Comfort Guide* is available on the Web at <http://www.hp.com/ergo>.

📝 IMPORTANT: To prevent damage to the monitor, do not touch the surface of the LCD panel. Pressure on the panel may cause nonuniformity of color or disorientation of the liquid crystals. If this occurs, the screen will not recover to its normal condition.

📝 IMPORTANT: To prevent the screen from getting scratched, defaced, or broken and to prevent damage to the control buttons, position the monitor facedown on a flat surface covered with protective sheet foam or a nonabrasive cloth.

Attaching the monitor stand

💡 TIP: Consider the placement of the monitor, because surrounding light and bright surfaces might cause interfering reflections.

📝 NOTE: The procedures for attaching a monitor stand might be different on other models.

1. Position the monitor head facedown on a flat surface covered by protective sheet made of foam or a clean, dry cloth.
2. Slide the stand into the recess on the back of the panel (1).
3. Insert the base into the bottom of the stand (2).

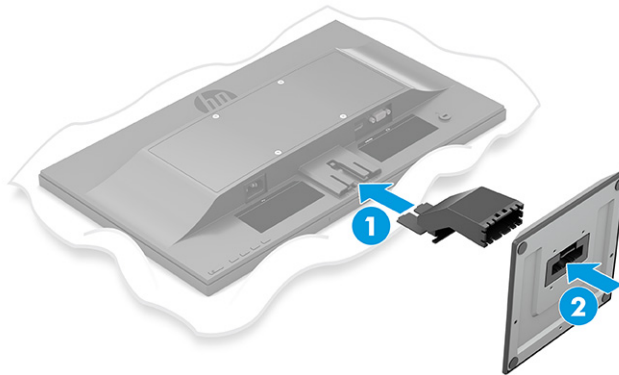

Mounting the monitor head

The monitor head can be attached to a wall, swing arm, or other mounting fixture.

IMPORTANT: This monitor supports the VESA industry-standard 100 mm mounting holes. To attach a third-party mounting solution to the monitor head, use four 4 mm, 0.7 pitch, and 10 mm long screws. Longer screws might damage the monitor. Be sure to verify that the manufacturer's mounting solution is compliant with the VESA standard and is rated to support the weight of the monitor head. For best performance, use the power and video cables provided with the monitor.

NOTE: This apparatus is intended to be supported by a UL-listed or CSA-listed wall-mount bracket.

Removing the monitor stand

IMPORTANT: Before disassembling the monitor, be sure that the monitor is turned off and all cables are disconnected.

1. Disconnect and remove all cables from the monitor.
2. Position the monitor facedown on a flat surface covered by protective sheet made of foam or a clean, dry cloth.
3. Push up the latch near the bottom center of the stand's mounting plate (1).
4. Slide the stand out of the recess (2).



Attaching the monitor head to a mounting device (select products only)

1. Remove the four screws from the VESA holes located on the rear of the monitor head.

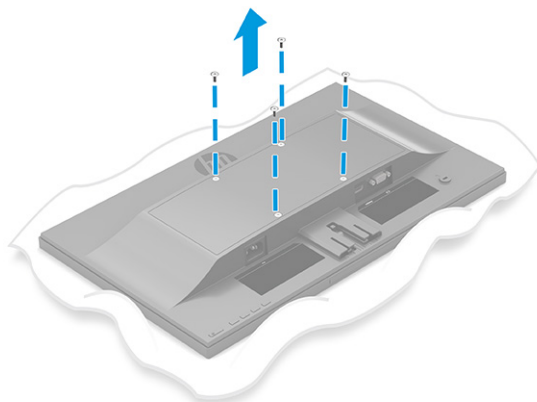

2. To attach the monitor head to a swing arm or other mounting device, insert four mounting screws through the holes on the mounting device and into the VESA screw holes on the back of the monitor head.

 **IMPORTANT:** If these instructions do not apply to your device, then follow the mounting device manufacturer's instructions when mounting the monitor to a wall or swing arm.

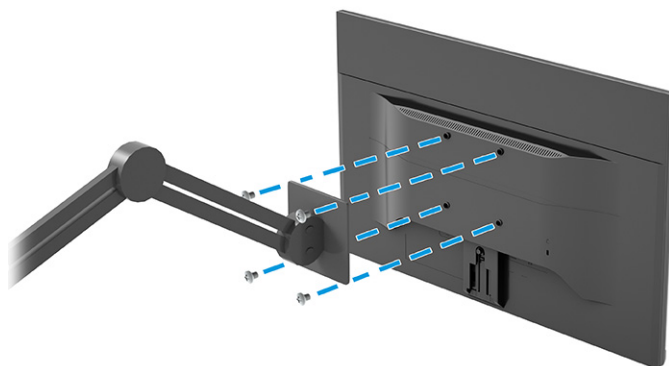

Connecting the cables

 **NOTE:** Depending on the model, the monitor may be capable of supporting VGA or HDMI inputs. The video mode is determined by the video cable used. The monitor automatically determines which inputs have valid video signals. The inputs can be selected through the OSD menu. The monitor ships with select cables. Not all cables shown in this section are included with the monitor.

1. Place the monitor in a convenient, well-ventilated location near the computer.
2. Connect a video cable.

 **NOTE:** The monitor automatically determines which inputs have valid video signals.

- Connect one end of a VGA cable to the VGA port on the rear of the monitor and the other end to the VGA port on the source device.

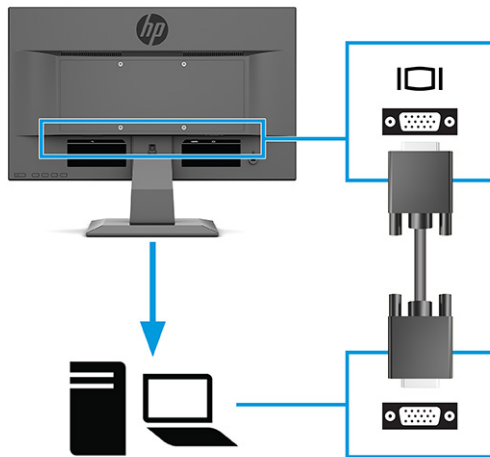

- Connect one end of an HDMI cable to the HDMI port on the rear of the monitor and the other end to the HDMI port on the source device.

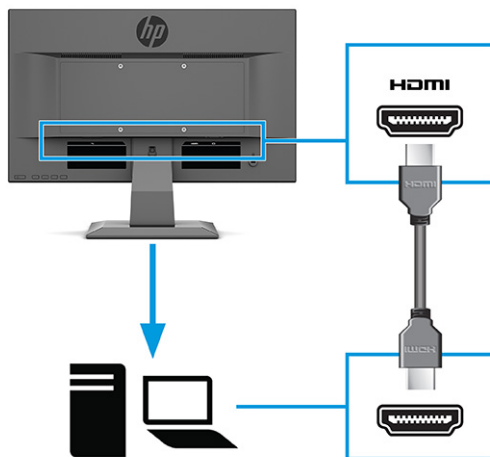

3. To enable sound from the monitor's speakers, connect one end of an audio cable to the audio-in jack on the monitor and the other end to the audio-out jack on the source device (select products only).

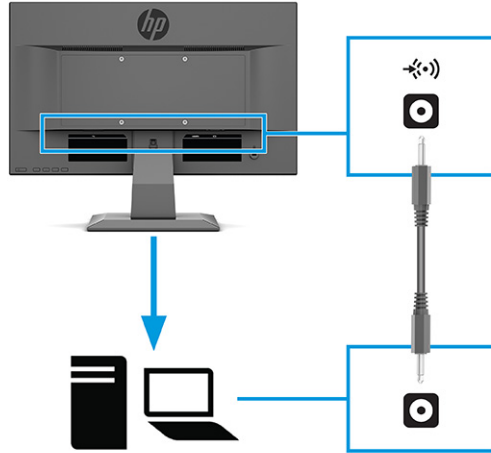

4. Connect one end of the power cord to the power connector on the rear of the monitor and the other end to a grounded AC outlet.

⚠ WARNING! To reduce the risk of electric shock or damage to the equipment:

Do not disable the power cord grounding plug. The grounding plug is an important safety feature.

Plug the power cord into a grounded (earthed) AC outlet that is easily accessible at all times.

Disconnect power from the equipment by unplugging the power cord from the AC outlet.

For your safety, do not place anything on power cords or cables. Arrange them so that no one may accidentally step on or trip over them. Do not pull on a cord or cable. When unplugging the power cord from the AC outlet, grasp the cord by the plug.

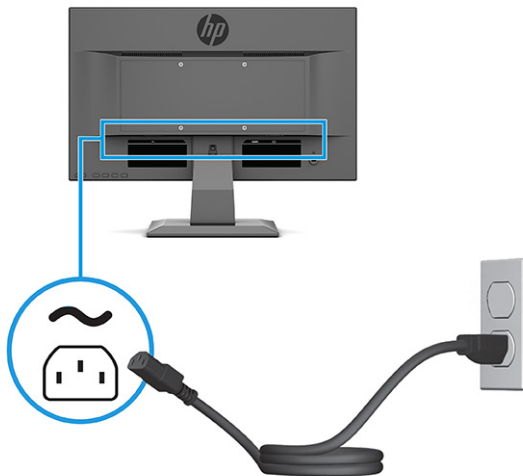

Adjusting the monitor

⚠ WARNING! To reduce the risk of serious injury, read the *Safety & Comfort Guide*. It describes proper workstation setup and proper posture, health, and work habits for computer users. The *Safety & Comfort Guide* also provides important electrical and mechanical safety information. The *Safety & Comfort Guide* is available on the Web at <http://www.hp.com/ergo>.

- ▲ Tilt the monitor head forward or backward to set it to a comfortable eye level.

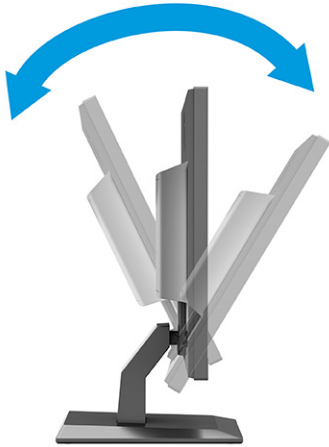

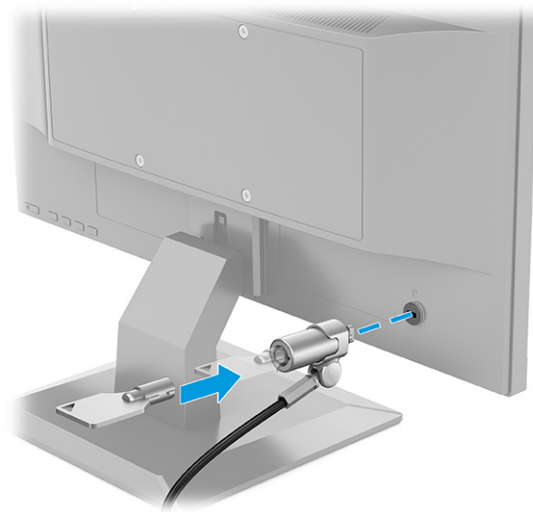

Installing a security cable

You can secure the monitor to a fixed object with an optional security cable available from HP. Use the key provided to attach and remove the lock.



Turning on the monitor

 **IMPORTANT:** Burn-in image damage may occur on monitors that display the same static image on the screen for 12 or more hours. To avoid burn-in image damage, you should always activate a screen saver application or turn off the monitor when it will not be in use for a prolonged period of time. Image retention is a condition that may occur on all LCD screens. Burn-in damage on the monitor is not covered under the HP warranty.

 **NOTE:** If pressing the power button has no effect, the Power Button Lockout feature might be enabled. To disable this feature, press and hold the monitor power button for 10 seconds.

 **NOTE:** On select HP monitors, you can disable the power light in the OSD menu. Press the **Menu** button to open the OSD, select **Power**, select **Power LED**, and then select **Off**.

- ▲ Press the power button on the monitor to turn it on.

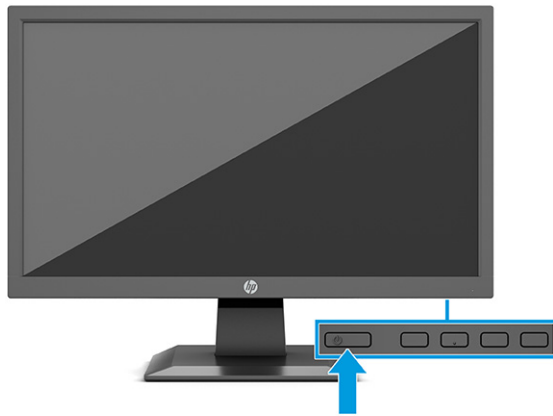

When the monitor is first turned on, a monitor status message is displayed for 5 seconds. The message shows which input is the current active signal, the status of the auto-switch source setting (On or Off; default setting is On), the current preset display resolution, and the recommended preset display resolution.

The monitor automatically scans the signal inputs for an active input and uses that input for the display.

HP watermark and image retention policy (select products only)

The IPS monitor models are designed with In-Plane Switching (IPS) display technology, which provides ultra-wide viewing angles and advanced image quality. IPS monitors are suitable for a wide variety of advanced image quality applications. This panel technology, however, is not suitable for applications that exhibit static, stationary, or fixed images for long periods of time without the use of screen savers. These types of applications may include camera surveillance, video games, marketing logos, and templates. Static images may cause image retention damage that could look like stains or watermarks on the monitor's screen.

Image retention damage on monitors that are in use 24 hours per day is not covered under the HP warranty. To avoid image retention damage, always turn off the monitor when it is not in use, or use the power management setting, if supported on your system, to turn off the monitor when the system is idle.

2 Using the monitor

Downloading software and utilities

You can download and install the following files from <http://www.hp.com/support>:

- INF (Information) file
- ICM (Image Color Matching) files

To download the files:

1. Go to <http://www.hp.com/support>.
2. Select **Software and Drivers**.
3. Select your product type.
4. Enter your HP monitor model in the search field and follow the on-screen instructions.

The Information file

The INF file defines monitor resources used by Windows® operating systems to ensure monitor compatibility with the computer's graphics adapter.

This monitor is Windows Plug and Play compatible, and the monitor will work correctly without installing the INF file. Monitor Plug and Play compatibility requires that the computer's graphics card is VESA DDC2-compliant and that the monitor connects directly to the graphics card. Plug and Play does not work through separate BNC-type connectors or through distribution buffers, boxes, or both.

The Image Color Matching file

The ICM files are data files that are used in conjunction with graphics programs to provide consistent color matching from monitor screen to printer, or from scanner to monitor screen. These files are activated from within graphics programs that support this feature.

 **NOTE:** The ICM color profile is written in accordance with the International Color Consortium (ICC) Profile Format specification.

Using the OSD menu

Use the OSD menu to adjust the screen image based on your viewing preferences. To access and make adjustments in the OSD:

- Use the buttons at the bottom of the monitor's front bezel.

To access the OSD menu and make adjustments:

1. If the monitor is not already on, press the power button to turn on the monitor.
2. Press the **Menu** button.
3. Use the three function buttons to navigate, select, and adjust the menu choices. The on-screen button labels vary, depending on which menu or submenu is active.

The following table lists possible menu selections in the OSD main menu.

Table 2-1 OSD menu options and descriptions

Main menu	Description
Brightness+	Adjusts the brightness, contrast, and black stretch levels of the screen.
Color	Selects and adjusts the screen color.
Image	Adjusts the screen image.
Input	Selects the video input signal (VGA or HDMI).
Power	Adjusts the power settings.
Menu	Adjusts the on-screen display (OSD) menu and function button controls.
Management	Adjusts the DDC/CI settings, selects the language in which the OSD menu is displayed (the factory default is English), adjusts the audio settings, and returns all OSD menu settings to the factory default settings.
Information	Selects and displays important information about the monitor.
Exit	Exits the OSD menu screen.



Using the function buttons

Pressing one of the function buttons activates the buttons and lights the icons above the buttons.



NOTE: The actions of the function buttons vary among monitor models.

For information about changing the function of the buttons, see [Reassigning the function buttons on page 14](#).

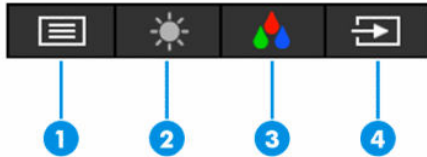

Table 2-2 Button names and descriptions

Button	Description
(1) Menu button	Opens the OSD main menu, selects a menu item from the OSD, or closes the OSD menu.
(2) Brightness+ button Assignable function button	Opens the Brightness+ adjustment scale.
(3) Color button Assignable function button	Opens the Color menu where you can adjust the monitor screen to a comfortable viewing light or select a preset view mode.
(4) Next Input or Next Active Input button Assignable function button	Switches the monitor's input source to the next active input.

Reassigning the function buttons

You can change the assignable function buttons from their default values so that when the buttons are activated, you can quickly access commonly used menu items. You cannot reassign the [Menu](#) button.

To reassign the function buttons:

1. Press the [Menu](#) button to open the OSD menu.
2. Select **Menu**, select **Assign Buttons**, and then select one of the available options for the button that you want to assign.

Using Auto-Sleep Mode

The monitor supports an OSD menu option called Auto-Sleep Mode that allows you to enable or disable a reduced power state for the monitor. When Auto-Sleep Mode is enabled (enabled by default), the monitor enters a reduced power state when the computer signals low power mode (absence of either horizontal or vertical sync signal).

Upon entering this reduced power state (sleep mode), the monitor screen is blanked, the backlight turns off, and the power light turns amber. The monitor draws less than 0.5 W of power when in this reduced power state. The monitor wakes from sleep mode when the computer sends an active signal to the monitor (for example, if you activate the mouse or keyboard).

To disable Auto-Sleep Mode in the OSD:

1. Press the **Menu** button to open the OSD.
2. In the OSD, select **Power**.
3. Select **Auto-Sleep Mode**, and then select **Off**.

Adjusting blue light output

Decreasing the blue light emitted by the monitor reduces the blue light exposure to your eyes. This monitor allows you to select a setting to reduce blue light output and create a more relaxing and less stimulating image while you read content on the screen.

To adjust the blue light output from the monitor:

1. Press one of the OSD buttons to activate the buttons, and then press the **Menu** button to open the OSD. Select **Color**.
2. Select a setting.
 - **Low Blue Light:** (TÜV certified) Reduces blue light for improved eye comfort.
 - **Night:** Adjusts to the lowest blue light and reduces the impact on sleep.
 - **Reading:** Optimizes blue light and brightness for indoor viewing.
3. Select **Save and Return** to save your setting and close the menu. Select **Cancel** if you do not want to save the setting.
4. In the Main menu, select **Exit**.

3 Support and troubleshooting

Solving common issues

The following table lists possible issues, the possible cause of each issue, and the recommended solutions.

Table 3-1 Common issues and solutions

Issues	Possible cause	Solution
Screen is blank or video is flashing.	Power cord is disconnected.	Connect the power cord.
	Monitor is off.	Press the monitor power button. NOTE: If pressing the power button has no effect, press and hold the power button for 10 sec to disable the Power Button Lockout feature.
	Video cable is improperly connected.	Connect the video cable properly. For more information, see Connecting the cables on page 8 .
	System is in Auto-Sleep Mode.	Press any key on the keyboard or move the mouse to inactivate the screen blanking utility.
	Video card is incompatible.	Open the OSD menu and select the Input menu. Set Auto-Switch Input to Off and manually select the input. or Replace the video card or connect the video cable to one of the computer's on-board video sources.
Image appears blurred, indistinct, or too dark.	Brightness setting is too low.	Open the OSD menu, and select Brightness to adjust the brightness scale as needed.
"Check Video Cable" is displayed on the screen.	Monitor video cable is disconnected.	Connect the appropriate video signal cable between the computer and monitor. Be sure that the computer power is off while connecting the video cable.
"Input Signal Out of Range" is displayed on screen.	Video resolution and/or refresh rate are set higher than the monitor supports.	Change the settings to a supported setting (see Preset display resolutions on page 27).
The monitor does not enter into a low-power sleep state.	The monitor's power saving control is disabled.	Open the OSD menu and select Power , select Auto-Sleep Mode , and then set auto-sleep to On .
"OSD Lockout" is displayed.	The monitor's OSD Lockout function is enabled.	Press and hold the Menu button for 10 sec to disable the OSD Lockout function.
"Power Button Lockout" is displayed.	The monitor's Power Button Lockout feature is enabled.	Press and hold the Power button for 10 sec to unlock the power button function.
FreeSync is enabled in monitor OSD, but refresh rate does not vary.	Variable refresh rate (VRR) might be disabled in the graphics card software.	Enable VRR in your graphics card software.
	The refresh rate might be set too low.	In Windows, set the refresh rate to its maximum setting.
	Content and/or hardware might not be VRR capable.	Verify the content being displayed is VRR capable.



Table 3-1 Common issues and solutions (continued)

Issues	Possible cause	Solution
		Be sure that a computer with an AMD Radeon graphics card or a AMD A-Series processor is connected to the monitor using a DisplayPort or HDMI cable.
The monitor is experiencing screen tearing.	FreeSync might not be enabled.	Open the OSD and enable FreeSync.

Button lockouts

Holding down the power button or **Menu** button for 10 seconds disables that button. You can re-enable the button by holding the button down again for 10 seconds. The button lockout function is available only when the monitor is on, an active signal is displayed, and the OSD menu is closed.

Using the auto-adjustment function (analog input)

The auto-adjustment feature automatically engages and attempts to optimize your screen under the following conditions:

- Monitor setup
- Factory reset of the computer
- Changing monitor resolution

You can manually optimize the screen performance for the VGA (analog) input at any time from the Auto Adjustment menu in the OSD. You can download the auto-adjustment pattern software utility from <http://www.hp.com/support>.

Do not use this procedure if the monitor is using an input other than VGA. If the monitor is using a VGA (analog) input, this procedure can correct the following image quality conditions:

- Fuzzy or unclear focus
- Ghosting, streaking, or shadowing effects
- Faint vertical bars
- Thin, horizontal scrolling lines
- An off-center picture

To use the auto-adjustment feature:

1. Turn the monitor on, and then wait for 20 minutes before adjusting.
2. Press the **Menu** button to open the OSD menu, select **Image**, and then select **Auto-Adjustment**. If the result is not satisfactory, continue with the procedure.

3. Open the auto-adjustment utility. (You can download this utility from <http://www.hp.com/support>.) The setup test pattern is displayed.

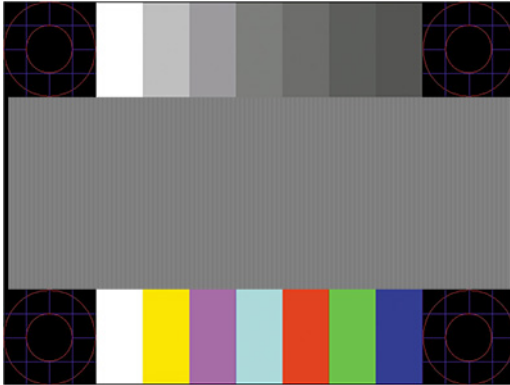

4. Press the `esc` key or any other key on the keyboard to exit the test pattern.

Optimizing image performance (analog input)

You can adjust two controls in the on-screen display to improve image performance: Clock and Phase (available in the OSD menu). Use these controls only when the auto-adjustment function does not provide a satisfactory image.

 **NOTE:** The Clock and Phase controls are adjustable only when you use an analog (VGA) input. These controls are not adjustable for digital inputs.

The Clock must first be set correctly because the Phase settings are dependent on the main Clock setting.

- **Clock:** Increases or decreases the value to minimize any vertical bars or stripes visible on the screen background.
- **Phase:** Increases or decreases the value to minimize video flickering or blurring.

 **NOTE:** When using the controls, you will obtain the best results by using the auto-adjustment pattern software utility. You can download this utility from <http://www.hp.com/support>.

When adjusting the Clock and Phase values, if the monitor images become distorted, continue adjusting the values until the distortion disappears. To restore the factory settings, press the **Menu** button to open the OSD menu, then select **Management**, select **Factory Reset**, and select **Yes**.

To eliminate vertical bars (Clock):

1. Press the **Menu** button to open the OSD menu, select **Image**, and then select **Clock and Phase**.
2. Select **Clock**, and then use the OSD buttons on the monitor that display up and down arrow icons to eliminate vertical bars. Press the buttons slowly so that you do not miss the optimum adjustment point.



3. After adjusting the Clock, if flickering, blurring, or bars appear on the screen, proceed to adjust the Phase.

To remove flickering or blurring (Phase):

1. Press the **Menu** button to open the OSD menu, select **Image**, and then select **Clock and Phase**.
2. Select **Phase**, and then use the OSD buttons on the monitor that display up and down arrow icons to eliminate flickering or blurring. Flickering or blurring may not be eliminated, depending on the computer or graphics controller card installed.

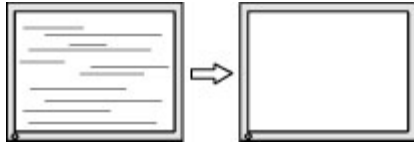

To correct screen position (Horizontal Position or Vertical Position):

1. Press the **Menu** button to open the OSD menu, select **Image**, and then select **Image Position**.
2. Press the OSD buttons on the monitor that display up and down arrow icons to properly adjust the position of the image in the display area of the monitor. The **Horizontal Position** shifts the image left or right; the **Vertical Position** shifts the image up or down.

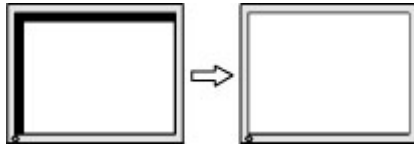

Contacting support

To resolve a hardware or software problem, go to <http://www.hp.com/support>. Use this site to get more information about your product, including links to discussion forums and instructions on troubleshooting. You can also find information about how to contact HP and open a support case.



NOTE: Contact customer support to replace the power cord or any other cables that shipped with your monitor.

Preparing to call technical support

If you cannot solve a problem using the troubleshooting tips in this section, you may need to call technical support. Have the following information available when you call:

- Monitor model number
- Monitor serial number
- Purchase date on invoice
- Conditions under which the problem occurred
- Error messages received
- Hardware configuration
- Name and version of the hardware and software you are using

Locating the serial number and product number

Depending on the product, the serial number and product number are located on a label on the rear of the monitor or on a label under the front bezel of the monitor head. You might need these numbers when contacting HP about the monitor.

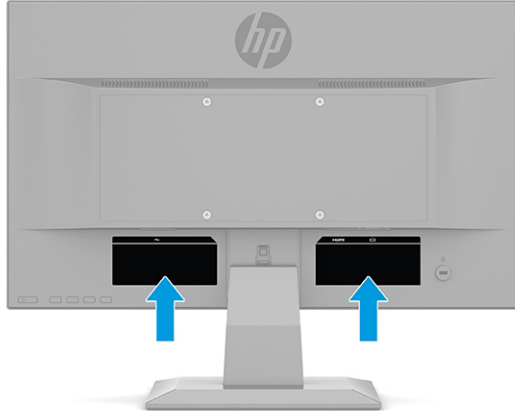

4 Maintaining the monitor

Maintenance guidelines

To enhance the performance and extend the life of the monitor:

- Do not open the monitor cabinet or attempt to service this product yourself. Adjust only those controls that are covered in the operating instructions. If the monitor is not operating properly or has been dropped or damaged, contact an authorized HP dealer, reseller, or service provider.
- Use only a power source and connection appropriate for this monitor, as indicated on the label or back plate of the monitor.
- Be sure that the total ampere rating of the products connected to the outlet does not exceed the current rating of the AC outlet and that the total ampere rating of the products connected to the cord does not exceed the rating of the cord. Look on the power label to determine the ampere rating (AMPS or A) for each device.
- Install the monitor near an outlet that you can easily reach. Disconnect the monitor by grasping the plug firmly and pulling it from the outlet. Never disconnect the monitor by pulling the cord.
- Turn the monitor off when it is not in use and use a screen saver program. Doing this can substantially increase the life expectancy of the monitor.



NOTE: A burned-in image on the monitor is not covered under the HP warranty.

- Never block the slots and openings of the cabinet or push objects into them. These openings provide ventilation.
- Do not drop the monitor or place it on an unstable surface.
- Do not allow anything to rest on the power cord. Do not walk on the cord.
- Keep the monitor in a well-ventilated area, away from excessive light, heat, or moisture.

Cleaning the monitor

1. Turn off the monitor and unplug the power cord from the AC outlet.
2. Disconnect any external devices.
3. Dust the monitor by wiping the screen and the cabinet with a soft, clean antistatic cloth.
4. For more difficult cleaning situations, use a 50/50 mix of water and isopropyl alcohol.



IMPORTANT: Do not use cleaners that contain petroleum-based materials such as benzene, thinner, or any volatile substance to clean the monitor screen or cabinet. These chemicals may damage the monitor.

IMPORTANT: Spray the cleaner onto a cloth and use the damp cloth to gently wipe the screen surface. Never spray the cleaner directly on the screen surface. It may run behind the bezel and damage the electronics. The cloth should be moist, but not wet. Water dripping into the ventilation openings or other points of entry can cause damage to the monitor. Allow the monitor to air-dry before use.

Shipping the monitor

Keep the original packing box in a storage area. You may need it later if you ship the monitor or move.

A Technical specifications

 **NOTE:** All specifications represent the typical specifications provided by HP component manufacturers; actual performance may vary either higher or lower.

For the latest specifications or additional specifications for this product, go to <http://www.hp.com/go/quickspecs/> and search for your specific monitor model to find the model-specific QuickSpecs.

68.6 cm (27.0 in) model specifications

Table A-1 68.6 cm (27.0 in) monitor specifications

Specification	Measurement	
Display, wide screen	68.6 cm	27.0 in
Type	IPS	
Viewable image size	68.6 cm diagonal	27.0 in diagonal
Maximum weight (unpacked)	4.5 kg	9.92 lb
Dimensions (include base)		
Height	44.77 cm	17.63 in
Depth	20.00 cm	7.87 in
Width	61.22 cm	24.10 in
Tilt adjustment range	-5° to 20°	
Environmental requirements		
Operating temperature	5°C to 35°C	41°F to 95°F
Storage temperature	-20°C to 60°C	-4°F to 140°F
Storage humidity	5% to 95% (noncondensing)	
Operating humidity	20% to 80% (noncondensing)	
Power source	100 V ac to 240 V ac 50/60 Hz	
Input terminal	One HDMI port, one VGA port	

61.0 cm (24.0 in) model specifications

Table A-2 61.0 cm (24.0 in) model specifications

Specification	Measurement	
Display, wide-screen	61.0 cm	24.0 in
Type	TN	
Viewable image size	61.0 cm diagonal	24.0 in diagonal
Maximum weight (unpacked, with stand)	3.3 kg	7.28 lbs



Table A-2 61.0 cm (24.0 in) model specifications (continued)

Specification	Measurement	
Dimensions (include base)		
Height	41.96 cm	16.52 in
Depth	18.60 cm	7.32 in
Width	56.86 cm	22.39 in
Tilt adjustment range	-5° to 20°	
Environmental requirements temperature		
Operating temperature	5°C to 35°C	41°F to 95°F
Storage temperature	-20°C to 60°C	-4°F to 140°F
Storage humidity	5% to 95% (noncondensing)	
Operating humidity	20% to 80% (noncondensing)	
Power source	100 V ac to 240 V ac 50/60 Hz	
Input terminal	One HDMI port, one VGA port	

60.5 cm (23.8 in) model specifications

Table A-3 60.5 cm (23.8 in) model specifications

Specification	Measurement	
Display, wide-screen	60.5 cm	23.8 in
Type	IPS	
Viewable image size	60.5 cm diagonal	23.8 in diagonal
Maximum weight (unpacked, with stand)	3.5 kg	7.72 lbs
Dimensions (include base)		
Height	40.50 cm	15.94 in
Depth	18.60 cm	7.32 in
Width	53.96 cm	21.24 in
Tilt adjustment range	-5° to 20°	
Environmental requirements temperature		
Operating temperature	5°C to 35°C	41°F to 95°F
Storage temperature	-20°C to 60°C	-4°F to 140°F
Storage humidity	5% to 95% (noncondensing)	
Operating humidity	20% to 80% (noncondensing)	
Power source	100 V ac to 240 V ac 50/60 Hz	
Input terminal	One HDMI port, one VGA port	

54.6 cm (21.5 in) model specifications

Table A-4 54.6 cm (21.5 in) model specifications

Specification	Measurement	
Display, wide-screen	54.6 cm	21.5 in
Type	TN	
Viewable image size	54.6 cm diagonal	21.5 in diagonal
Maximum weight (unpacked, with stand)	2.85 kg	6.28 lbs
Dimensions (include base)		
Height	38.1 cm	15.01 in
Depth	18.1 cm	7.12 in
Width	50.5 cm	19.88 in
Tilt adjustment range	-5° to 20°	
Environmental requirements temperature		
Operating temperature	5°C to 35°C	41°F to 95°F
Storage temperature	-40°C to 65°C	-40°F to 149°F
Storage humidity	5% to 95% (noncondensing)	
Operating humidity	20% to 80% (noncondensing)	
Power source	100 V ac to 240 V ac 50/60 Hz	
Input terminal	One HDMI port, one VGA port	

52.6 cm (20.7 in) model specifications

Table A-5 52.6 cm (20.7 in) model specifications

Specification	Measurement	
Display, wide-screen	52.6 cm	20.7 in
Type	TN	
Viewable image size	52.6 cm diagonal	20.7 in diagonal
Maximum weight (unpacked, with stand)	2.6 kg	5.73 lbs
Dimensions (include base)		
Height	37.41 cm	14.73 in
Depth	18.60 cm	7.32 in
Width	49.03 cm	19.30 in
Tilt adjustment range	-5° to 20°	
Environmental requirements temperature		
Operating temperature	5°C to 35°C	41°F to 95°F
Storage temperature	-20°C to 60°C	-4°F to 140°F

Table A-5 52.6 cm (20.7 in) model specifications (continued)

Specification	Measurement
Storage humidity	5% to 95% (noncondensing)
Operating humidity	20% to 80% (noncondensing)
Power source	100 V ac to 240 V ac 50/60 Hz
Input terminal	One HDMI port, one VGA port (select products only)

49.5 cm (19.5 in) model specifications

Table A-6 49.5 cm (19.5 in) model specifications

Specification	Measurement
Display, wide-screen	49.5 cm 19.5 in
Type	TN
Viewable image size	49.5 cm diagonal 19.5 in diagonal
Maximum weight (unpacked, with stand)	2.81 kg 6.19 lbs
Dimensions (include base)	
Height	35.36 cm 13.92 in
Depth	19.00 cm 7.48 in
Width	46.26 cm 18.21 in
Tilt adjustment range	-5° to 25°
Environmental requirements temperature	
Operating temperature	5°C to 35°C 41°F to 95°F
Storage temperature	-40°C to 65°C -40°F to 149°F
Storage humidity	5% to 95% (noncondensing)
Operating humidity	20% to 80% (noncondensing)
Power source	100 V ac to 240 V ac 50/60 Hz
Input terminal	One HDMI port, one VGA port

47.0 cm (18.5 in) model specifications

Table A-7 47.0 cm (18.5 in) model specifications

Specification	Measurement
Display, wide-screen	47.0 cm 18.5 in
Type	TN
Viewable image size	47.0 cm diagonal 18.5 in diagonal
Maximum weight (unpacked, with stand)	2.45 kg 5.4 lbs

Table A-7 47.0 cm (18.5 in) model specifications (continued)

Specification	Measurement	
Dimensions (include base)		
Height	34.58 cm	13.61 in
Depth	15.70 cm	6.18 in
Width	44.14 cm	17.38 in
Tilt adjustment range	-5° to 22°	
Environmental requirements temperature		
Operating temperature	5°C to 35°C	41°F to 95°F
Storage temperature	-40°C to 65°C	-40°F to 149°F
Storage humidity	5% to 95% (noncondensing)	
Operating humidity	20% to 80% (noncondensing)	
Power source	100 V ac to 240 V ac 50/60 Hz	
Input terminal	One HDMI port (select products only), one VGA port	

Preset display resolutions

The following display resolutions are the most commonly used modes and are set as factory defaults. This monitor automatically recognizes these preset modes, and they will appear properly sized and centered on the screen.

68.6 cm (27.0 in) models

Table A-8 Preset display resolutions

Preset	Pixel format	Horz freq (kHz)	Vert freq (Hz)
1	640 × 480	31.469	59.940
2	720 × 400	31.469	70.087
3	800 × 600	37.879	60.317
4	1024 × 768	48.363	60.004
5	1280 × 720	45.000	60.000
6	1280 × 800	49.702	59.810
7	1280 × 1024	63.981	60.020
8	1440 × 900	55.935	59.887
9	1600 × 900	60.000	60.000
10	1680 × 1050	65.290	59.954
11	1920 × 1080	67.500	60.000

61.0 cm (24.0 in) models

Table A-9 Preset display resolutions

Preset	Pixel format	Horz freq (kHz)	Vert freq (Hz)
1	640 × 480	31.469	59.940
2	640 × 480	37.500	75.000
3	720 × 400	31.469	70.087
4	800 × 600	37.879	60.317
5	800 × 600	46.875	75.000
6	1024 × 768	48.363	60.004
7	1024 × 768	60.023	75.029
8	1280 × 720	45.000	60.000
9	1280 × 720	55.894	74.925 (HDMI)
10	1280 × 800	49.702	59.810
11	1280 × 800	62.795	74.934 (HDMI)
12	1280 × 1024	63.981	60.020
13	1280 × 1024	79.976	75.025
14	1440 × 900	55.935	59.887
15	1440 × 900	70.635	74.984 (HDMI)
16	1600 × 900	60.000	60.000
17	1680 × 1050	65.290	59.954
18	1920 × 1080	67.500	60.000
19	1920 × 1080	83.894	74.973

60.5 cm (23.8 in) models

Table A-10 Preset display resolutions

Preset	Pixel format	Horz freq (kHz)	Vert freq (Hz)
1	640 × 480	31.469	59.940
2	720 × 400	31.469	70.087
3	800 × 600	37.879	60.317
4	1024 × 768	48.363	60.004
5	1280 × 720	45.000	60.000
6	1280 × 800	49.702	59.810
7	1280 × 1024	63.981	60.020
8	1440 × 900	55.935	59.887

Table A-10 Preset display resolutions (continued)

Preset	Pixel format	Horz freq (kHz)	Vert freq (Hz)
9	1600 × 900	60.000	60.000
10	1680 × 1050	65.290	59.954
11	1920 × 1080	67.500	60.000

54.6 cm (21.5 in) models

Table A-11 Preset display resolutions

Preset	Pixel format	Horz freq (kHz)	Vert freq (Hz)
1	640 × 480	31.469	59.940
2	720 × 400	31.469	70.087
3	800 × 600	37.879	60.317
4	1024 × 768	48.363	60.004
5	1280 × 720	45.000	60.000
6	1280 × 800	49.702	59.810
7	1280 × 1024	63.981	60.020
8	1440 × 900	55.935	59.887
9	1600 × 900	60.000	60.000
10	1680 × 1050	65.290	59.954
11	1920 × 1080	67.500	60.000

52.6 cm (20.7 in) models

Table A-12 Preset display resolutions

Preset	Pixel format	Horz freq (kHz)	Vert freq (Hz)
1	640 × 480	31.469	59.940
2	720 × 400	31.469	70.087
3	800 × 600	37.879	60.317
4	1024 × 768	48.363	60.004
5	1280 × 720	45.000	60.000
6	1280 × 800	49.702	59.810
7	1280 × 1024	63.981	60.020
8	1440 × 900	55.935	59.887
9	1600 × 900	60.000	60.000

Table A-12 Preset display resolutions (continued)

Preset	Pixel format	Horz freq (kHz)	Vert freq (Hz)
10	1680 × 1050	65.290	59.954
11	1920 × 1080	67.500	60.000

49.5 cm (19.5 in) models

Table A-13 Preset display resolutions

Preset	Pixel format	Horz freq (kHz)	Vert freq (Hz)
1	640 × 480	31.469	59.940
2	720 × 400	31.469	70.087
3	800 × 600	37.879	60.317
4	1024 × 768	48.363	60.004
5	1280 × 720	45.000	60.000
6	1280 × 800	49.702	59.810
7	1280 × 1024	63.981	60.020
8	1366 × 768	60.000	60.000
9	1440 × 900	55.935	59.887
10	1600 × 900	60.000	60.000

47.0 cm (18.5 in) models

Table A-14 Preset display resolutions

Preset	Pixel format	Horz freq (kHz)	Vert freq (Hz)
1	640 × 480	31.469	59.940
2	720 × 400	31.469	70.087
3	800 × 600	37.879	60.317
4	1024 × 768	48.363	60.004
5	1280 × 720	45.000	60.000
6	1366 × 768	60.000	60.000

Preset timing resolutions

Table A-15 Preset timing resolutions

Preset	Timing name	Pixel format	Horz freq (kHz)	Vert freq (Hz)
1	480p	720 × 480	31.469	60

Table A-15 Preset timing resolutions (continued)

Preset	Timing name	Pixel format	Horz freq (kHz)	Vert freq (Hz)
2	576p	720 × 576	31.250	50
3	720p50	1280 × 720	37.500	50
4	720p60	1280 × 720	45.000	60
5	1080p60	1920 × 1080	67.500	60
6	1080p50	1920 × 1080	56.250	50

Energy saver feature

The monitor supports a reduced power state. The reduced power state is initiated if the monitor detects the absence of either the horizontal sync signal or the vertical sync signal. Upon detecting the absence of these signals, the monitor screen is blank, the backlight is turned off, and the power light turns amber. When the monitor is in the reduced power state, the monitor uses <0.5 W of power. There is a brief warm-up period before the monitor returns to its normal operating state.

See the computer manual for instructions on setting the energy saver mode (sometimes called power management feature).



NOTE: This power saver feature works only when the monitor is connected to a computer that has energy saver features.

By selecting the settings in the monitor Sleep Timer utility, you can also program the monitor to initiate the reduced power state at a predetermined time. When the monitor Sleep Timer utility initiates the reduced power state, the power light blinks amber.

B Accessibility

HP and accessibility

Because HP works to weave diversity, inclusion, and work/life into the fabric of the company, it is reflected in everything HP does. HP strives to create an inclusive environment focused on connecting people to the power of technology throughout the world.

Finding the technology tools you need

Technology can unleash your human potential. Assistive technology removes barriers and helps you create independence at home, at work, and in the community. Assistive technology helps increase, maintain, and improve the functional capabilities of electronic and information technology. For more information, see [Finding the best assistive technology on page 33](#).

The HP commitment

HP is committed to providing products and services that are accessible for people with disabilities. This commitment supports the company's diversity objectives and helps ensure that the benefits of technology are available to all.

The HP accessibility goal is to design, produce, and market products and services that can be effectively used by everyone, including people with disabilities, either on a stand-alone basis or with appropriate assistive devices.

To achieve that goal, this Accessibility Policy establishes seven key objectives to guide HP actions. All HP managers and employees are expected to support these objectives and their implementation in accordance with their roles and responsibilities:

- Raise the level of awareness of accessibility issues within HP, and provide employees with the training they need to design, produce, market, and deliver accessible products and services.
- Develop accessibility guidelines for products and services, and hold product development groups accountable for implementing these guidelines where competitively, technically, and economically feasible.
- Involve people with disabilities in the development of accessibility guidelines and in the design and testing of products and services.
- Document accessibility features, and make information about HP products and services publicly available in an accessible form.
- Establish relationships with leading assistive technology and solution providers.
- Support internal and external research and development that improves assistive technology relevant to HP products and services.
- Support and contribute to industry standards and guidelines for accessibility.

International Association of Accessibility Professionals (IAAP)

IAAP is a not-for-profit association focused on advancing the accessibility profession through networking, education, and certification. The objective is to help accessibility professionals develop and advance their careers and to better enable organizations to integrate accessibility into their products and infrastructure.

As a founding member, HP joined to participate with other organizations to advance the field of accessibility. This commitment supports HP's accessibility goal of designing, producing, and marketing products and services that people with disabilities can effectively use.

IAAP will make the profession strong by globally connecting individuals, students, and organizations to learn from one another. If you are interested in learning more, go to <http://www.accessibilityassociation.org> to join the online community, sign up for newsletters, and learn about membership options.

Finding the best assistive technology

Everyone, including people with disabilities or age-related limitations, should be able to communicate, express themselves, and connect with the world using technology. HP is committed to increasing accessibility awareness within HP and with our customers and partners. Whether it's large fonts that are easy on the eyes, voice recognition that lets you give your hands a rest, or any other assistive technology to help with your specific situation—a variety of assistive technologies make HP products easier to use. How do you choose?

Assessing your needs

Technology can unleash your potential. Assistive technology removes barriers and helps you create independence at home, at work, and in the community. Assistive technology (AT) helps increase, maintain, and improve the functional capabilities of electronic and information technology.

You can choose from many AT products. Your AT assessment should allow you to evaluate several products, answer your questions, and facilitate your selection of the best solution for your situation. You will find that professionals qualified to do AT assessments come from many fields, including those licensed or certified in physical therapy, occupational therapy, speech/language pathology, and other areas of expertise. Others, while not certified or licensed, can also provide evaluation information. You will want to ask about the individual's experience, expertise, and fees to determine if they are appropriate for your needs.

Accessibility for HP products

The following links provide information about accessibility features and assistive technology, if applicable, included in various HP products. These resources will help you select the specific assistive technology features and product(s) most appropriate for your situation.

- [HP Elite x3—Accessibility Options \(Windows 10 Mobile\)](#)
- [HP PCs—Windows 7 Accessibility Options](#)
- [HP PCs—Windows 8 Accessibility Options](#)
- [HP PC's—Windows 10 Accessibility Options](#)
- [HP Slate 7 Tablets—Enabling Accessibility Features on Your HP Tablet \(Android 4.1/Jelly Bean\)](#)
- [HP SlateBook PCs—Enabling Accessibility Features \(Android 4.3, 4.2/Jelly Bean\)](#)
- [HP Chromebook PCs—Enabling Accessibility Features on Your HP Chromebook or Chromebox \(Chrome OS\)](#)
- [HP Shopping—peripherals for HP products](#)

If you need additional support with the accessibility features on your HP product, see [Contacting support on page 36](#).

Additional links to external partners and suppliers that may provide additional assistance:

- [Microsoft Accessibility information \(Windows 7, Windows 8, Windows 10, Microsoft Office\)](#)
- [Google Products accessibility information \(Android, Chrome, Google Apps\)](#)

- [Assistive Technologies sorted by impairment type](#)
- [Assistive Technology Industry Association \(ATIA\)](#)

Standards and legislation

Standards

Section 508 of the Federal Acquisition Regulation (FAR) standards was created by the US Access Board to address access to information and communication technology (ICT) for people with physical, sensory, or cognitive disabilities. The standards contain technical criteria specific to various types of technologies, as well as performance-based requirements which focus on functional capabilities of covered products. Specific criteria cover software applications and operating systems, web-based information and applications, computers, telecommunications products, video and multimedia, and self-contained closed products.

Mandate 376 – EN 301 549

The EN 301 549 standard was created by the European Union within Mandate 376 as the basis for an online toolkit for public procurement of ICT products. The standard specifies the functional accessibility requirements applicable to ICT products and services, together with a description of the test procedures and evaluation methodology for each accessibility requirement.

Web Content Accessibility Guidelines (WCAG)

Web Content Accessibility Guidelines (WCAG) from the W3C's Web Accessibility Initiative (WAI) helps web designers and developers create sites that better meet the needs of people with disabilities or age-related limitations. WCAG advances accessibility across the full range of web content (text, images, audio, and video) and web applications. WCAG can be precisely tested, is easy to understand and use, and allows web developers flexibility for innovation. WCAG 2.0 has also been approved as [ISO/IEC 40500:2012](#).

WCAG specifically addresses barriers to accessing the web experienced by people with visual, auditory, physical, cognitive, and neurological disabilities, and by older web users with accessibility needs. WCAG 2.0 provides characteristics of accessible content:

- **Perceivable** (for instance, by addressing text alternatives for images, captions for audio, adaptability of presentation, and color contrast)
- **Operable** (by addressing keyboard access, color contrast, timing of input, seizure avoidance, and navigability)
- **Understandable** (by addressing readability, predictability, and input assistance)
- **Robust** (for instance, by addressing compatibility with assistive technologies)

Legislation and regulations

Accessibility of IT and information has become an area of increasing legislative importance. The following links provide information about key legislation, regulations, and standards.

- [United States](#)
- [Canada](#)
- [Europe](#)
- [Australia](#)
- [Worldwide](#)

Useful accessibility resources and links

The following organizations might be good resources for information about disabilities and age-related limitations.



NOTE: This is not an exhaustive list. These organizations are provided for informational purposes only. HP assumes no responsibility for information or contacts you encounter on the Internet. Listing on this page does not imply endorsement by HP.

Organizations

- American Association of People with Disabilities (AAPD)
- The Association of Assistive Technology Act Programs (ATAP)
- Hearing Loss Association of America (HLAA)
- Information Technology Technical Assistance and Training Center (ITTATC)
- Lighthouse International
- National Association of the Deaf
- National Federation of the Blind
- Rehabilitation Engineering & Assistive Technology Society of North America (RESNA)
- Telecommunications for the Deaf and Hard of Hearing, Inc. (TDI)
- W3C Web Accessibility Initiative (WAI)

Educational institutions

- California State University, Northridge, Center on Disabilities (CSUN)
- University of Wisconsin - Madison, Trace Center
- University of Minnesota computer accommodations program

Other disability resources

- ADA (Americans with Disabilities Act) Technical Assistance Program
- ILO Global Business and Disability network
- EnableMart
- European Disability Forum
- Job Accommodation Network
- Microsoft Enable

HP links

[Our contact webform](#)

[HP comfort and safety guide](#)

[HP public sector sales](#)

Contacting support



NOTE: Support is in English only.

- Customers who are deaf or hard of hearing who have questions about technical support or accessibility of HP products:
 - Use TRS/VRS/WebCapTel to call (877) 656-7058 Monday through Friday, 6 a.m. to 9 p.m. Mountain Time.
- Customers with other disabilities or age-related limitations who have questions about technical support or accessibility of HP products, choose one of the following options:
 - Call (888) 259-5707 Monday through Friday, 6 a.m. to 9 p.m. Mountain Time.
 - Complete the [Contact form for people with disabilities or age-related limitations](#).