

BATTERY MONITOR

 **RENOGY**

Version 3.1



Warning

Please read this guide carefully to avoid incorrect connections that can cause the battery monitor to malfunction and/or create a fire hazard. Disconnect the negative pole of the battery before installation.

★The Renogy Battery Monitor can't be exposed in the sun for a long time or in the environment with large amounts of ultraviolet radiation when using or storing, in winter ($< -10\text{ C}$) and summer ($>60\text{ C}$) otherwise the life span of the LCD will be shortened.

Battery Safety

- Do NOT let the positive (+) and negative (-) terminals of the battery touch each other.
- Explosive battery gases may be present while charging. Be certain there is enough ventilation to release the gases.
- Be careful when working with large lead acid batteries. Wear eye protection and have fresh water available in case there is contact with the battery acid.
- It is the user's responsibility to operate the equipment in a safe manner. Do not charge batteries in an enclosed environment unless allowed by the manufacturer of the battery.
- Never connect a load to a battery without using fuses or circuit breakers.
- Please follow the battery manufacturer's safety instructions.

General Information

The Renogy Battery Monitor is a high precision device (also known as coulometer), which can test the voltage, current, and capacity of a battery to help users know the state of charge at any time. The Renogy Battery Monitor has a memory function which allows users to set a low voltage capacity alarm. It is suitable for mobile and portable equipment, e-bike, motorcycles, electric wheelchairs, and so on.

★ The Renogy Battery Monitor is suitable for lithium batteries, lead acid batteries and nickel-metal hydride batteries that have voltage from 10-120V.

Identification of Parts



LCD Interface



Shunt/Sampler Holder

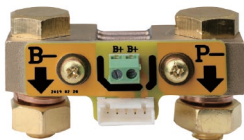

500A Shunt/Sampler



20ft (6m)
Shielded Wire



3ft (1m)
20 AWG B+ Wire

Dimension

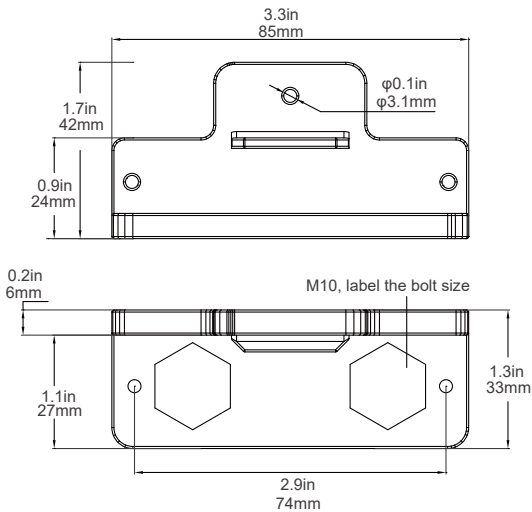
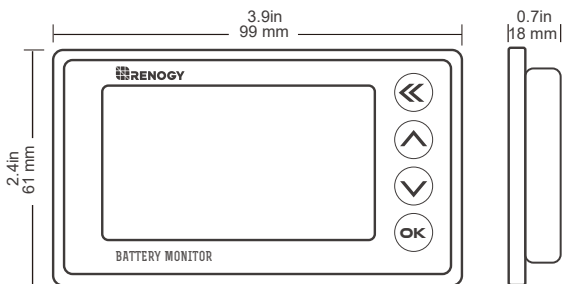

Installation

■ Connection/Setup

First, connect the Shunt in series to the negative circuit of your battery. B- of shunt connects to B- of the battery. P- of shunt connects to P- of output and C- of charge.

Then take a wire of 0.3-0.75 mm². One end of the wire connects to positive of battery, another end connects to B+ of Shunt (either one is ok).

Finally connect the Shunt to the Renogy Battery Monitor by the shielded wire and the screen of the Renogy Battery Monitor display should turn on.

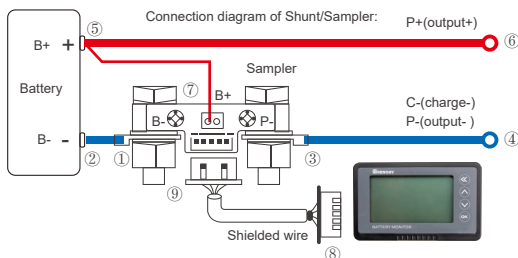

Attention: Please connect as shown. The shunt must be series connected to the negative circuit, DO NOT connect to the positive circuit.

■ Mounting

The Renogy Battery Monitor is fixed by tabs, so it is easy to install. First, open a rectangular orifice on your equipment panel according to the size. Then put The Renogy Battery Monitor into the rectangular orifice, and make sure the tabs are locked.

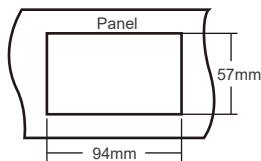

Operation

Interface description

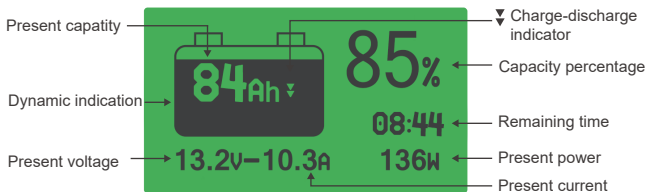

Use steps

1. Wiring and checking the current:

Power on after the connection as shown in the figure. The battery voltage, current and capacity percentage should be displayed on the screen. If there is no display, the power should be turned off to check if the connection is correct. Then discharge or charge the battery and check if the current value and the actual value are consistent.

If the error is large, check the wiring again. (Make sure that all current flowing through the battery passes through the sampler.)

2. Detection and Setting of Battery Effective Capacity:

The battery's effective capacity (CAP) needs to be set correctly before first use, see "Usage Settings".

If the effective capacity of the battery is unknown, you need to follow the steps below:

A. Enter the capacity setting interface and set the capacity value as large as possible. (For example, it is set to 30Ah if the estimated value is 20Ah.);

B. Empty the battery pack and clear the capacity of electric meter to zero, and then charge the battery pack;

C. The display's capacity is set to the CAP of the electric meter when fully charged.

3. Capacity Homing (The battery capacity is cleared or full capacity setting.):

The capacity displayed on the electric meter is not the actual value of the battery after the first use or replacement of the battery. And zero or full capacity operation is required:

A. Press and hold the button "  " after the battery is discharged (empty) and the capacity value is cleared to 0%;

B. Or Press and hold the button "  " after the battery is full charged and the capacity value is set to 100%.

Then it will work as expected and you don't need to do this later.

■ User settings

Press and hold the button "  " for 3 seconds to enter the settings

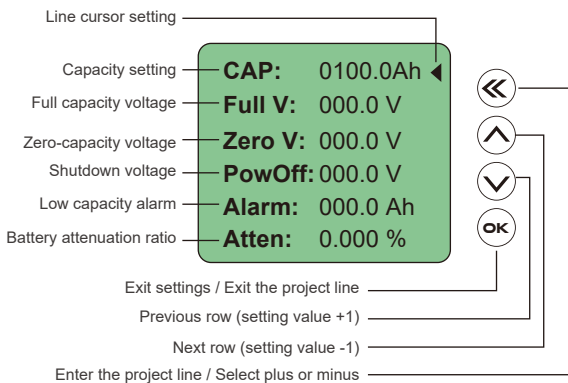

CAP

Effective capacity of battery: The default is 100Ah. Please set according to the actual effective capacity of the battery pack, otherwise the capacity percentage display will be incorrect;

Full V

Full capacity voltage: When the voltage is higher than the set value, the capacity will be automatically set to 100%.

Zero V

Zero capacity voltage: The capacity value is automatically set to 0% if below this voltage. The voltage value will flash, and the buzzer will alarm once per 10s if the discharge continues.

PowOff

Shutdown voltage: Backlight and LCD OFF and no display if below this capacity;

Alarm

Low capacity alarm: The percentage and battery symbol will flash, and the buzzer will sound per 10s if below this capacity.

Atten

Battery attenuation ratio: After the battery Capacity cumulatively once per cycle, The capacity value is automatically changed according to this ratio.

Precautions:

Do not set Full V and Zero V without knowing the voltage characteristics of battery pack (full voltage and vent voltage).

The default of Full V and Zero V is 0V. It is invalid.

While charging the battery, the LCD screen's backlight will also be slowly flashing. In order to turn off the backlight function, Long press front Keyboard can turn off the backlight, Long press again Keyboard can Wake up the backlight.

Troubleshooting

- When connecting the load, if the backlight is blinking, the B- and P- of the shunt are wired inversely.
- When the battery current is low the Renogy Battery Monitor will enter a low power (sleep mode) and the backlight will turn off, press any button and the backlight will turn on for 10s.
- When the current changes frequently the data acquisition may produce an error, and it may affect the accuracy.
- When charging or discharging. The Renogy Battery Monitor will be working and the capacity displayed will be real-time numbers.

Technical Specifications

Description	Parameter
Working Voltage	10.0 - 120.0 V
Working dissipation	10.0 - 15.0 mA
Standby dissipation	1.0 - 2.0 mA
Voltage accuracy	±1.0 %
Current accuracy	±1.0 %
Capacity accuracy	±1.0 %
Backlight on current(>50A)	100 mA
Preset capacity value	0.1 - 9999.0 Ah
Temperature range	-10-60°C (14-140°F)
Weight (LCD Interface)	2.6 oz / 75 g
Size (LCD Interface)	3.9*2.4*0.7 inch (9.9*6.1*1.8 cm)
Shielded Wire	20ft (6m)
B+ Wire	3ft (1m)

Renogy reserves the right to change the contents of this manual without notice.

US | ♦ 2775 E Philadelphia St, Ontario, CA 91761, USA
☎ 909-287-7111
🌐 www.renogy.com
✉ support@renogy.com

CN | ♦ 苏州高新区科技城培源路1号5号楼-4
☎ 400-6636-605
🌐 <https://www.renogy.cn>
✉ support@renogy.cn

JP | 🌐 <https://www.renogy.jp>
✉ supportjp@renogy.com

CA | 🌐 <https://ca.renogy.com>
✉ supportca@renogy.com

AU | 🌐 <https://au.renogy.com>
✉ supportau@renogy.com

UK | 🌐 <https://uk.renogy.com>
✉ supportuk@renogy.com

DE | 🌐 <https://de.renogy.com>
✉ supportde@renogy.com