

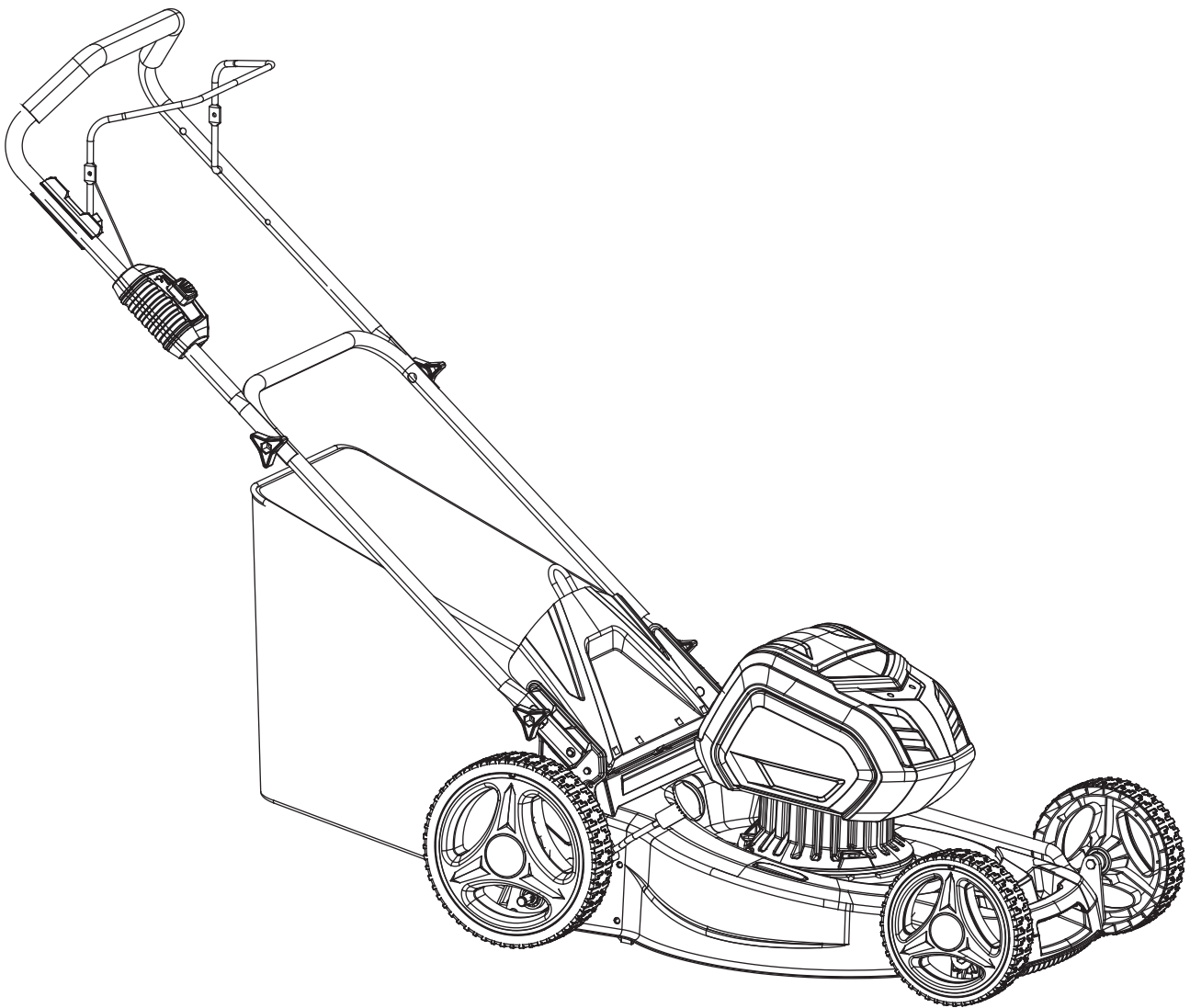

Model: PTG2220

Lithium-Ion Battery Lawn Mower OPERATOR'S MANUAL



Before using your new PTG2220 Lithium-Ion Battery operated Lawn Mower, please read this manual carefully to understand the proper use of your mower. Keep this manual handy for future reference.

	DO NOT RETURN TO STORE!
	HAVE QUESTIONS OR NEED SERVICE?
866-591-8921	support@pulsar-products.com

Contents

GENERAL IDENTIFICATION	3
PRODUCT SPECIFICATIONS	4
ASSEMBLY INSTRUCTIONS	5
1.Unpacking	5
2.Packing List	5
3.Installing upper handle and hardware (See Fig.2)	6
4.Unfolding and adjusting handle (See Fig.3)	6
5.Installing the grass catcher bag (See Fig.4)	6
6. Installing the Lithium-Ion battery pack (See Fig.5)	6
7.Remove Lithium-Ion battery pack (See Fig.5).	7
8.Adjustment of cutting height (See Fig.6)	7
9.Starting/Stopping the PTG2220 Lithium-Ion Battery Lawn Mower (See Fig.7)	7
10.Safety precautions (See Fig.8)	8
11. Emptying the grass catcher bag (See Fig.9)	8
IMPORTANT SAFETY INFORMATION	9
1、 General safety rules	9
2、 Safety rules for battery and charger	10
3、 Battery tool use and safety rules	11
4、 Operation	11-12
5、 Service.....	13
SYMBOLS MARKED ON THE PRODUCT	14
CHARGING THE BATTERY PACK	15
MAINTENANCE AND STORING	16
1. Replacing the cutting blade (See Fig.13)	16
2. Replacing the Lithium-Ion battery	17
3. Cleaning the mower	17
4. Storing the mower	17
TROUBLESHOOTING	18

GENERAL IDENTIFICATION

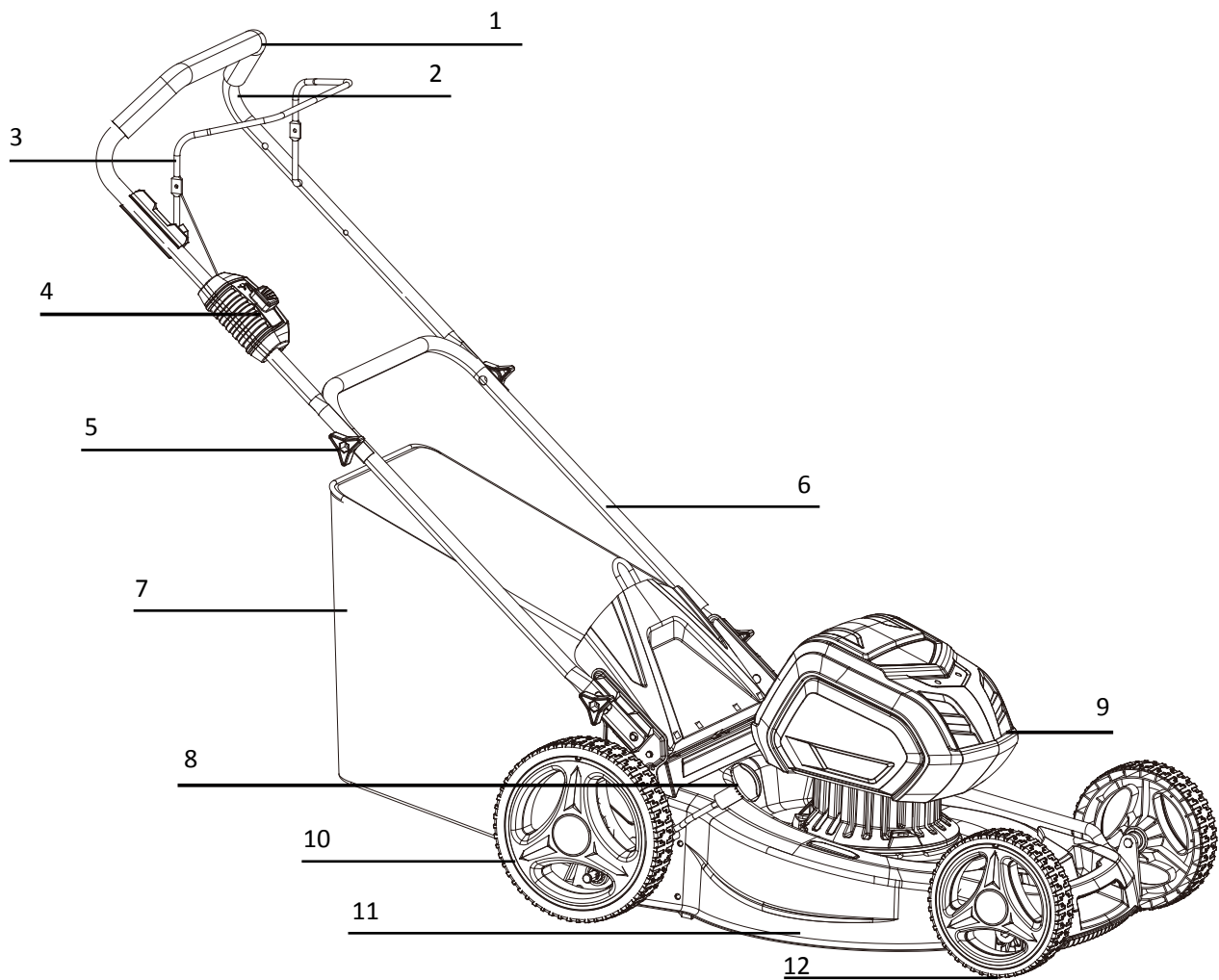

Fig 1

- | | |
|-----------------------------------|---------------------------------|
| 1. Soft grip | 7. Grass catcher bag |
| 2. Upper handle | 8. Single lever height adjuster |
| 3. Safety interlock bail | 9. Motor / Battery Enclosure |
| 4. Start, interlock switch | 10. Rear wheel(s) |
| 5. Fixing knob with carriage bolt | 11. Mower Deck |
| 6. Lower handle | 12. Front Wheel(s) |

PRODUCT SPECIFICATIONS

PTG2220 Lithium-Ion Battery Lawn Mower	
Rated Voltage(V)	56Vdc
Speed (RPM)	2900
Grass catcher capacity	17 gallon
Cutting width	20"
Height adjustment	1" to 3"
Battery Charger.	
Model	DC6020L
Input	120Vac . 60Hz
Output	58.8Vdc . 2A
Allowable charging temperature	41-104° F
Lithium-Ion Battery Pack	
Model	DL14S2P140
Voltage	56Vdc
Capacity (wh)	204
Number of cells in battery	28

ASSEMBLY INSTRUCTION

1.Unpacking

- 1) Carefully remove the product and any accessories from the box. Make sure that all items listed on the packing list are included.
- 2) Inspect the product carefully to make sure that no damage occurred during shipping.
- 3) Do not discard the packing material until you have carefully inspected and satisfactorily operated the Lawn Mower.
- 4) If any parts are damaged or missing, Please call Pulsar Products at 866.591.8921; support@pulsar-products.com for assistance.

2.Packing List

- 1) PTG2220 Lithium-Ion Battery Lawn Mower
- 2) Safety Key
- 3) Grass Catcher bag
- 4) Lithium-Ion Battery Pack (56Vdc, 204wh)
- 5) Battery Charger. (58.8Vdc, 2A)
- 6) Operator's Manual
- 7) Soft Grip Handle

WARNING:

- 1) If any parts are damaged or missing, do not operate this product until those parts are replaced. Using a product with damaged or missing parts could result in serious personal injury.
- 2) Do not attempt to modify this product or create accessories not recommended for use with this product. Any such alteration or modification constitutes misuse which could result in a hazardous condition, leading to possible serious personal injury.
- 3) Do not insert Safety Key until assembly is complete and you are ready to now. Failure to comply could result in accidental starting and possible serious personal injury.
- 4) To prevent accidental starting that could cause serious personal injury, always remove the Safety key and Lithium-Ion battery pack from the Lawn Mower when assembling parts.
- 5) Do not operate the lawn mower without the proper safety devices in place and in good working order. Never operate the lawn mower with damaged safety devices. Operation of this product with damaged or missing parts could result in serious personal injury.
- 6) Danger- risk of serious injury. Remove the safety key and battery pack from the Lawn Mower before making any adjustments, changing accessories, or storing Lawn Mower. Such preventive safety measures reduce the risk of starting the Lawn Mower accidentally.

4. Installing upper Handle and Hardware(See Fig.2)

- 1) After the upper handrail (③) is installed on the lower handrail (①)with insulating sleeve (②),Align the holes of the upper and lower handrails (①, ③) Insert the bolts (④);
- 2) Install the washer (⑤) and knob(⑥) on the bolt and tighten them.

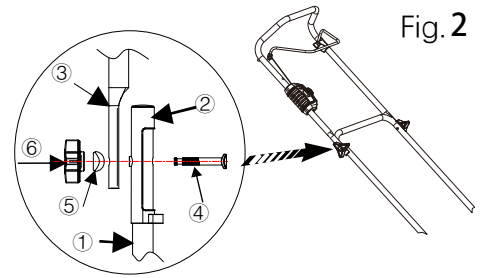

Fig.2

3. Unfolding and adjusting handle (See Fig.3)

- 1) Pull up and back on the upper handle to raise the handle into operating position, make certain the handles bolt holes align into place.
- 2) Tighten the lower handle hardware on both sides.
- 3) Tighten the upper handle hardware on both sides.

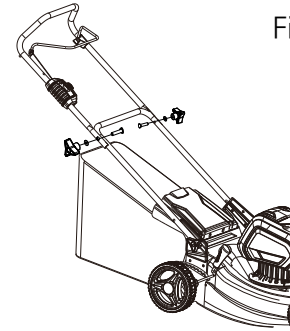

Fig.3

5. Installing the grass catcher bag (See Fig.4)

- 1) Lift the chute cover .
- 2) Lift the grass catcher by its handle and place under the chute cover so that the hook on the grass catcher frame are seated into the slots in the handle bracket.
- 3) Release the chute cover. When installed correctly, the hooks on the grass catcher will rest securely in the slots on the handle brackets.

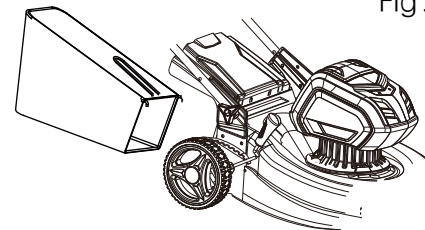

Fig.4

6. Installing the Lithium-Ion battery pack (See Fig.5)

- 1) Lift and hold up the battery door(①).
- 2) Place the Lithium-Ion battery pack (②) on the mower. Align guided ribs on Lithium-Ion battery pack (②) with grooves in the Lawn Mower battery port.
- 3) Make sure the latch on the top of the Lithium-Ion battery pack (②) snaps in place and that Lithium-Ion battery pack (②) is fully seated and secure in the Lawn Mower before beginning operation.
- 4) Insert the Safety Key (③).
- 5) If the Lawn Mower will not be used immediately, do not insert the Safety key. Close the battery door.

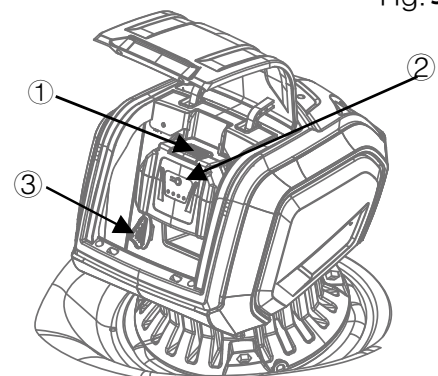

Fig.5

7. Removing Lithium-Ion battery pack (See Fig.5).

- 1) Release the safety interlock lever to stop the Lawn Mower.
- 2) Remove the Safety Key (③).
- 3) Press and hold the battery latch button at the top of the Lithium-Ion battery pack (②).
- 4) Remove Lithium-Ion battery pack (②) from the Lawn Mower.

8. Adjustment of cutting height (See Fig.6)

Grasp the height adjustment lever (①) and move it toward the back or front to adjust the cutting height. The cutting height (the blade to the ground distance) can be adjusted from 1 inch (position 1) to 3 inches (position 7).

⚠ WARNING:

- 1) Make this adjustment only when the blade is stopped, and the Safety Key is removed.

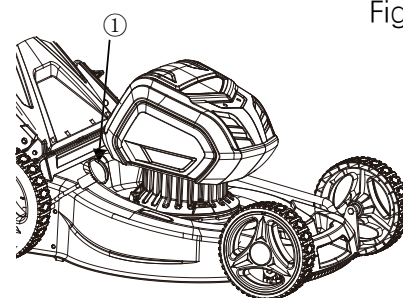

Fig. 6

9. Starting/Stopping the PTG2220 Lithium-Ion Battery Lawn Mower (See Fig. 7)

- 1) Open the battery door and insert the Safety Key into the slot. Then close the battery door. (See Fig.6)
- 2) Pull the safety interlock lever (②) down to the handle to start the PTG2220 Lithium-Ion Battery Lawn Mower .
- 3) Press and hold the safety interlock button (①) (See Fig.7)

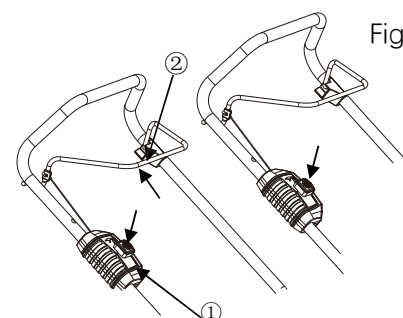

Fig.7

If you release the safety interlock lever, the PTG2220 Lithium-Ion Battery Lawn Mower will stop.

⚠ WARNING

- 1) Cutting elements may continue to rotate for a short time after the power is switched off.
- 2) The operation of any Lawn Mower can result in foreign objects and debris being thrown into the eyes, which can cause severe eye damage. Always wear safety glasses while operating the mower and while performing any adjustments or repairs.
- 3) Ensure that other people and pets remain at least 100' (30 m) away when the mower is in use.
- 4) Inspect the cutting area. Remove all stones, sticks, wire, bones, and other debris that might be thrown by the rotating blade.

⚠ CAUTION:

- 1) The blade starts turning as soon as the power is turned on.
- 2) Do not attempt to override the operation of the start button, Safety Key or safety interlock lever.

10. Safety precautions

- 1) Always operate with the mulching plug or grass catcher in the correct position.
- 2) Always stop the mower before removing the grass catcher or adjusting the cutting height.
- 3) Before mowing, remove all foreign objects from the lawn that may be thrown by the Lawn Mower. While mowing, stay alert for any foreign objects which may have been missed.
- 4) Never lift the rear of the mower while starting the power or during operation. Never place your hands or feet underneath the deck or into the rear discharge chute while the mower is running.

11. Emptying the grass catcher bag (See Fig.9)

- 1) Stop the Lawn Mower, wait for the blades to completely stop, and remove Safety Key.
- 2) Lift the rear chute cover.
- 3) Lift the grass catcher bag by its handle to remove from the Lawn Mower .
- 4) Empty grass clippings.
- 5) Lift rear chute cover and reinstall the grass catcher bag as described previously in the operator's manual.

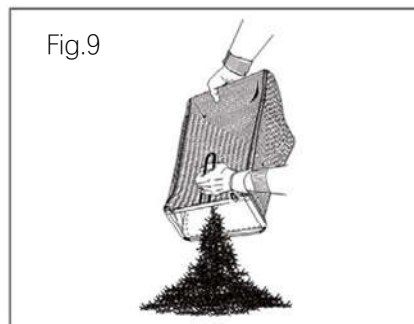

IMPORTANT SAFETY INFORMATION

 **WARNING:** When using your PTG2220 Lithium-Ion Battery Lawn Mower, basic safety precautions should always be followed to reduce the risk of fire, electric shock, and personal injury; including reading, understanding, and following ALL instructions and warnings in this manual and on the Lawn Mower , engine and attachments.

1. General Safety Rules

Read the instructions carefully. Be familiar with the controls and proper use of this equipment.

1. Do not use your PTG2220 Lithium-Ion Battery Lawn Mower in rainy, damp, or wet locations.
2. Do not operate your PTG2220 Lithium-Ion Battery Lawn Mower while under the influence of alcohol or drugs.
3. Keep Children Away – All visitors should be kept a safe distance from work area.
4. Dress Properly – Do not wear loose clothing or jewelry. They can be catch in moving parts. The use of heavy gloves and footwear is recommended when operating this mower.
5. Use Safety Glasses – Use a face shield and dust mask if operation is dusty.
6. Use Correct Lawn Mower – Do not use your PTG2220 Lithium-Ion Battery Lawn Mower for any job except that for which is intended.
7. Do Not Overreach – Keep proper footing and balance at all times.
8. Stay Alert – Watch what you are doing. Use good common sense. Do not operate your PTG2220 Lithium-Ion Battery Lawn Mower when you are tired.
9. When not in use, the PTG2220 Lithium-Ion Battery Lawn Mower should be stored in a covered dry and secure place, with the battery removed – and out of reach of children.
10. Maintain your PTG2220 Lithium-Ion Battery Lawn Mower with care – Keep cutting blade clean and sharp for best and safest performance.
11. Follow instructions for maintaining accessories. Keep handles dry, clean, and free of oil.
12. Keep all guards in place and in working order.
13. Keep hands and feet away from cutting area.
14. Foreign objects (such as rocks) struck by the PTG2220 Lithium-Ion Battery Lawn Mower blade can cause severe injuries to persons. The lawn should always be carefully examined and cleared of all foreign objects and debris prior to each mowing.
15. If your PTG2220 Lithium-Ion Battery Lawn Mower strikes a foreign object, follow these steps:
 - I . Stop your PTG2220 Lithium-Ion Battery Lawn Mower by releasing the switch lever.
 - II . Remove Safety Key,then the Battery.
 - III . Inspect for damage.

⚠ WARNING: To reduce the risk of injury to persons, do not operate without grass catcher or guard in place.

⚠ WARNING: Safe Practices for Walk-Behind Mower. This Lawn Mower is capable of amputating hands and feet and throwing objects. Failure to observe the above safety instructions could result in serious injury or death.

⚠ NOTICE: Under normal use, the grass catcher assembly is subject to deterioration and abrasion, Therefore, it should be frequently checked and replaced as needed. Only use Pulsar Products Original Equipment spare parts to maintain correct function and safe operation.

2. Safety rules for battery and charger

⚠ WARNING: Read all safety warnings and instructions. Failure to follow the warnings and instructions may result in electric shock, fire, and/or serious injury.

1. Prevent unintentional starting. Ensure the Safety Key is removed before connecting battery pack, picking up, or carrying the Lawn Mower. Carrying the Lawn Mower with the Battery and Safety Key installed invites accidents.
2. Disconnect and remove the battery pack from the Lawn Mower before making any adjustments, changing accessories, or storing it. This practice eliminates the risk of starting the Lawn Mower accidentally.
3. Use only with a type DL14S2P140 for 56Vdc PTG2220 Lithium-Ion Battery Lawn Mower. Use only the following type chargers: DC6020L by PULSAR. Use Lawn Mower only with specifically designated battery packs. Use of any other battery packs may create a risk of injury, fire, and equipment damage.
Contact your dealer, or Pulsar Support at 866.591.8921; support@pulsar-products.com
4. Recharge the battery only with the charger specified by the manufacturer. A charger that is suitable for one type of battery pack may create a risk of fire when used with another battery pack.
5. When battery pack is not in use, keep it away from small metal objects, like paper clips, coins, keys, nails, screws, or other debris capable of making a connection between battery terminals. Shorting the battery terminals together may cause burns or a fire.
6. Under abusive conditions, toxic smoke and material may be ejected from the battery; avoid contact. If a battery fire occurs within the Lawn Mower, immediately move it downwind and away from people. If possible, deploy and discharge a dry-chemical BC Fire Extinguisher on to the battery.
7. Do not use a battery pack or Lawn Mower that has been damaged or modified. Damaged or modified batteries may exhibit unpredictable behavior resulting in fire, explosion, and risk of injury.
8. Do not expose a battery pack or Lawn Mower to fire or excessive temperature. Exposure to fire or temperature above 122°F (50°C) may cause severe damage.
9. Follow all charging instructions and do not charge the battery pack or Lawn Mower outside of the temperature range specified in the instructions. Charging outside of the specified temperature range may damage the battery and increase the risk of fire.
10. Stop the unit and disconnect battery pack and safety start key when not in use. Carry the unit only with the power stopped and the safety start key and battery pack removed from the Lawn Mower.
11. Do not use the charger when the ambient temperature is above 104°F (40°C) or below 41°F (5°C).
12. Do not operate charger with a damaged cord or plug which could cause shorting and electric shock. If damaged, replace the charger with an identical charger from an authorized Pulsar service provider.
13. Unplug charger from outlet before attempting any maintenance or cleaning to reduce the risk of electric shock.

3. Battery tool use and safety rules

1. Do not charge your PTG2220 Lithium-Ion Battery in rain or in wet locations. Use only the original Pulsar type and size battery.
2. Do not dispose of the battery in a fire. The cells may explode. Check with local authorities for special disposal instructions.
3. Do not open or mutilate the battery. Released electrolyte is reactive and may cause damage to the eyes or skin. It is toxic if swallowed. If this happens, seek emergency medical attention at once!
4. Exercise care in handling batteries in order not to short-circuit the battery with conducting materials such as rings, bracelets, and keys. The battery or conductor may overheat and cause burns.
5. The battery should be recharged when it fails to produce sustained power and the Lawn Mower shuts down.
6. The battery is not fully charged from the factory. Before attempting to use, it must be fully charged.

 **DANGER:** Never short-circuit the battery or expose it to moisture. Do not store it together with any metal parts that could short-circuit the contacts. The battery could overheat, start burning or explode.

 **WARNING:** If internal substances contained within the battery contacts the skin, wash off these substances immediately with plenty of water. If these substances contact the eyes, rinse with plenty of water and seek emergency medical treatment at once!

 **WARNING:** Do not open the battery pack for any reason! Do not place the battery into fire or water; it can explode. The rechargeable battery must never be discarded in common trash, regardless of whether used or unused. You must return it to an approved battery collection point in accordance with local regulations.

4. Operation

1. Clear the operating area of any foreign objects and debris which could be thrown by or interfere with operation of the Lawn Mower.
2. Keep the area of operation clear of all bystanders, particularly small children. Stop the Lawn Mower if anyone enters the area.
3. Do not operate the Lawn Mower without the entire grass catcher, discharge chute, or other safety devices in place and functioning properly. Check frequently for signs of wear or deterioration and replace those parts as needed.
4. Wear appropriate personal protective equipment such as safety glasses, hearing protection, and safety footwear.
5. Before using, always visually inspect to see whether the blades, blade bolt and blade mount are worn or damaged. Replace worn or damaged blades and mounts in sets to preserve balance.
6. Only operate the Lawn Mower in daylight or adequate artificial light.
7. Avoid holes, ruts, bumps, rocks, or other hidden hazards. Uneven terrain could overturn the Lawn Mower, or cause operator to lose their balance or footing.
8. Do not put hands or feet near rotating parts or under the Lawn Mower. Always keep clear of the discharge opening.
9. Do not direct discharged material toward anyone. Avoid discharging material against a wall or obstruction. Material may ricochet back toward the operator. Stop the Lawn mower when crossing gravel surfaces.

-
10. Do not leave a running Lawn Mower unsupervised. Always park on level ground and stop Lawn Mower, and remove safety key.
 11. Do not mow in reverse unless absolute necessary. Always look down and behind before and while backing.
 12. While mowing, always wear substantial safety footwear and long trousers. Do not operate the Lawn Mower while barefoot or wearing open sandals; Avoid wearing clothing that is loose fitting or that has hanging cords or ties.
 13. Tragic accidents can occur if the operator is not alert to the presence of children. Children are often attracted to the Lawn Mower and mowing activity. Never assume that children will remain where you last saw them.
 14. Keep children out of the operating area and under the watchful care of a responsible adult other than the Lawn mower operator.
 15. SLOPE SPECIFIC NOTE – Slopes are a major factor in Lawn mower related accidents. Operation on slopes requires extra caution.
 16. Travel in the manufacturer recommended direction on slopes, across the face slope.
 17. Avoid mowing wet grass. Poor footing could cause a slip and fall accident.
 18. Do not operate Lawn Mower under any condition where traction, steering, or stability is questionable.
Tires could slide even if the wheels are stopped.
 19. Always keep the Lawn Mower under complete control when going down slopes.
 20. Avoid starting and stopping on slopes. Avoid making sudden changes in speed or direction.
Make turns slowly and gradually.
 21. Use extra care while operating Lawn Mower with a grass catcher or other attachment(s). They can affect the stability of the Lawn Mower.
 22. Do not mow excessively steep slopes with a walk-behind Lawn Mower.
 23. HAULING – Use task appropriate ramps for loading and unloading a Lawn Mower for transport.
 24. Do not tilt the Lawn Mower when starting it.
 25. Never pick up or carry a Lawn Mower while it is running.
 26. Stop the Lawn Mower and remove safety key and battery, make sure that all moving parts have come to a complete stop-whenver you step away.
 27. Keep all nuts, bolts, and screws tight to be sure that the Lawn Mower is in safe working condition.
 28. Replace worn or damaged parts immediately.
 29. Be careful during adjustment of the Lawn Mower to prevent entrapment of the fingers between moving and fixed parts.
 30. After use and before storage, remove the battery and key from the Lawn Mower and check for damage.
 31. Use only specified replacement parts and accessories approved by Pulsar. Any other accessories or attachments may increase the risk of injury.
 32. Do not touch uninsulated portion of any electrical connector or uninsulated battery terminal.
 33. Do not expose battery charger to wet or damp conditions, Water entering charger will increase the risk of electric shock.
 34. Do not modify or attempt to repair the Lawn Mower or the battery pack (as applicable) except as indicated in the instructions for use and care.
 35. Have service performed by a qualified repair center using only genuine Pulsar replacement parts. This will ensure that the safety and integrity of the product is maintained.











5. Service

- 1) Keep Lawn Mower in good working order. Replace worn or damaged parts before using.
- 2) Use caution when servicing blades. Wrap the blade(s) in heavy cloth or wear heavy gloves.
Replace damaged blades at once. Do not attempt to repair or alter blade(s).

Use and store the Lawn Mower, within acceptable ambient temperature range, refer to the table below:

	Required Ambient Temperature Range
Mower Operation	41 °F - 104 °F (5 °C - 40 °C)
Mower Storage	32 °F - 100 °F (0 °C - 38 °C)
Battery Operation	41 °F - 104 °F (5 °C - 40 °C)
Battery Discharging	41 °F - 104 °F (0 °C - 40 °C)
Battery Storage	32 °F - 104 °F (0 °C - 40 °C) for 3 months before charging is required.
Charger Operation	41 °F - 104 °F (5 °C - 40 °C)

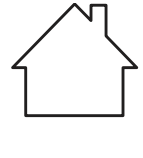
SYMBOLS MARKED ON THE PRODUCT

	Read this instruction book carefully before using the PTG2220 Lithium-Ion Battery Lawn Mower and keep it in a safe place for future reference.		Keep bystanders away.
	Wear safety rated footwear and eye protection .		Do not expose Lawn Mower to rain or wet conditions.
	Keep hands and feet away from blade and cutting area		Switch off Lawn Mower and remove the Safety Key first, then remove the Battery before cleaning and before leaving the Lawn Mower unattended for any period of time
	Do not operate on slopes greater than 15°. Mow across the surface of slopes, never up and down.		Beware of electric shock hazard
	Remove the key first then the remove battery ,Wait for all components of Lawn Mower to completely stop before touching them.		The battery charger is intended for indoor use only.
	The Lawn Mower is protected against ingress of water drops from vertical direction		Unusable power tools do not belong in household trash. They must be taken to an approved collection point for environmentally friendly disposal in accordance with local regulations.

The following words and meanings are intended to explain the levels of risk associated with this product.

	DANGER	Indicates a hazard with a high level of risk, if not avoided, will result in death or serious injury.
	WARNING	Indicates a hazard with a medium level of risk, if not avoided, could result in death or serious injury.
	CAUTION	Indicates a hazard with a low level of risk, if not avoided, could result in minor or moderate injury.
	NOTICE	(Without Safety Alert Symbol) Indicates a situation that may result in property damage.

CHARGING THE BATTERY PACK

1) The battery indicator shows the battery level and whether there is any fault with the battery. After the Lawn Mower is switched off, or after pressing the battery indicator button, the battery level will display for 5 seconds. When an error occurs, the warning indicator on the battery will illuminate. (See Fig.10)





LED FUNCTIONS	CHARGE STATUS
	0 - 10%
	10 - 25%
	25 - 50%
	50 - 75%
	75 - 100%

Fig.10

2) Plug in the battery charger first, the indicator light on the charger should be red. Next slide the battery pack into the charger, until it clicks into place and the indicator light on the charger changes from red to green, and the indicator light of the battery pack flashes, indicating charging. (See Fig.11)

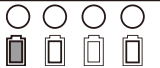
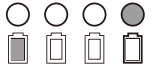
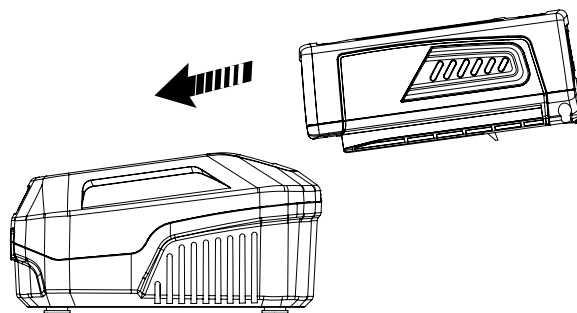

Fig.11

3) Once the battery indicator turns green and does not flash any more, the battery is fully charged and can be removed from the charger. (See Fig.12)

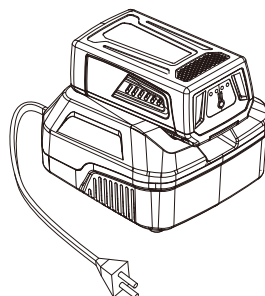

Fig.12

 **CAUTION**

Do not charge the PTG2220 Lithium-Ion Battery in rain or in wet locations.

MAINTENANCE AND STORAGE

1. Replacing the cutting blade (See Fig.13)

⚠ DANGER: Risk of serious injury. Remove the battery pack from the Lawn Mower before making any adjustments, changing accessories, or storing Lawn Mower. Such preventive safety measures reduce the risk of starting the Lawn Mower accidentally.

Use ONLY a genuine Pulsar replacement blade.

- 1) Remove Safety key, then remove the battery.
- 2) When wearing heavy leather padded gloves, wedge a section of 2×4 between the blade(④) and the deck of the mower to prevent the blade from rotating when removing the center hub bolt(①).
- 3) Using socket wrench, loosen the center hub bolt (①), removing butterfly washer (②) and blade washer (③) then remove the blade (④). Turn the bolt COUNTER-CLOCKWISE to loosen it .
- 4) Remove the blade holder and blade cushion ring.
- 5) When reinstalling the blade, the sharpened edge of the blade should face the ground. Assemble the blade bolt (①), blade washer(②) , blade (③), blade seat and blade seat gasket (④), Using socket wrench, tighten the blade bolt clockwise into the threaded shaft hole.

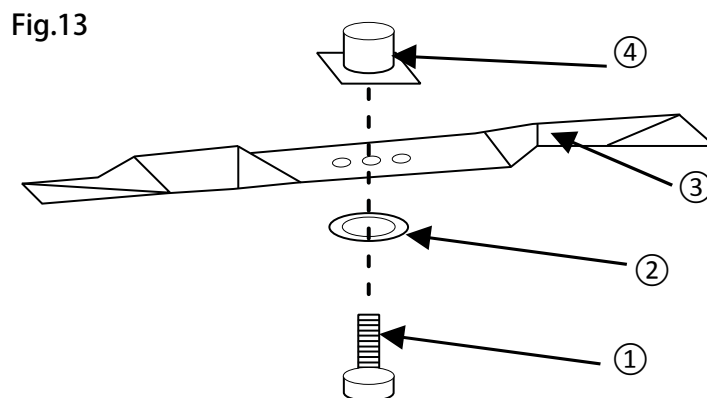

⚠ WARNING : Always protect your hands by wearing heavy gloves and/or wrapping the cutting edges with heavy cloth when performing any maintenance on the blade. Always remove the Safety Key and Battery Pack when servicing or transporting the PTG2220 Lithium-Ion Battery Lawn Mower .

2. Replacing the Lithium-Ion battery

The PTG2220 Lithium-Ion Battery Lawn Mower battery is designed for maximum life. However, like any battery, it will eventually need to be replaced.

Charge the new Lithium-Ion battery pack before use.

Install the new Lithium-Ion battery:

1. Remove the Safety Key, then Carefully remove the Lithium-Ion battery pack.
2. Install the new Lithium-Ion battery pack.
3. Take the old Lithium-Ion battery pack to a recycling center that accepts Lithium-Ion batteries.
Never dispose of Lithium-Ion battery in fire or regular household trash.

3. Cleaning the mower

Remove any build-up of grass and leaves on or around the battery cover (do not use water).

Occasionally wipe the mower clean with a damp cloth. If debris builds up on the underside of the mower during use, stop the power, remove the Safety Key and the Battery Pack, and then tilt the mower forward or on its side, and scrape it clean using an appropriate tool.

4. Storing the mower

The following steps should be taken to prepare the PTG2220 Lithium-Ion Battery Lawn Mower for storage.

1. Remove the Safety Key and store it in a secure location out of the reach of children. Removal of the battery is not required for storage.
2. Clean the mower as described in the previous section.
3. Inspect the blade, and replace it, if required (refer to the Maintenance section).
4. Store the mower in a dry, clean location, do not store it next to corrosive materials, such as fertilizer or rock salt.
5. Store the mower in a sheltered, cool, dry place, out of the reach of children. Do not cover the Lawn Mower with plastic sheet. Plastic coverings trap moisture in the mower which can cause corrosion.

TROUBLESHOOTING

Fault	Possible cause	Remedial action
The PTG2220 Lithium-Ion Battery Lawn Mower does not start	The battery is not charged.	Charge the battery
	The interlock switch is defective.	Replace the switch
	Grass jammed at blade.	Remove battery, check under deck for jams.
	The battery is not fully attached.	Check the connection between the mower and the battery.
	Battery may require service or replacement.	Contact customer service center or replace battery
	Safety Key is not installed.	Insert the Safety Key
The mower cuts grass unevenly.	The lawn is rough or uneven. The cutting height is not set properly.	Check the mowing area. Move the wheels to a higher setting.
The mower does not perform well	Wet grass clippings are sticking to the underside of the deck	Remove excessive grass from underside of deck before mowing.
The mower does not mulch properly.	The mulching plug is missing.	Install the mulching plug.
The mower is hard to push.	The grass is too tall, or the cutting height is too low. The rear of the mower housing and the blade are dragging in thick grass.	Raise the cutting height. Empty the grass clippings from the grass catcher bag.
The mower is excessively Noise and vibrates.	The power shaft is damaged. The blade is unbalanced.	Stop the mower, remove Safety Key and Battery, and inspect for damage. Repair before restarting.

⚠ WARNING: Before performing any maintenance or cleaning work, always remove Safety Key and battery !

⚠ CAUTION: Faults which are not rectified with the aid of this table must be addressed by an authorized Pulsar repair center only.