

gorenje

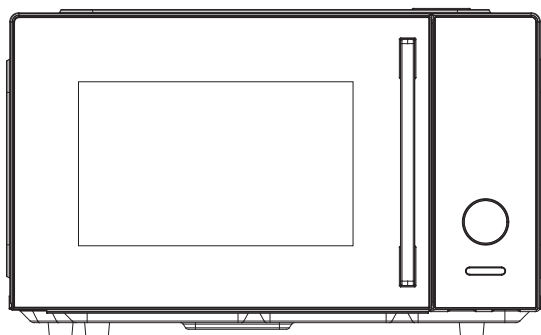

MO23S3W5
MO23S3B5

www.gorenje.com

Instruction manual / Microwave oven

EN4

DEAR CUSTOMER

We sincerely thank you for your purchase. We believe you will soon find ample evidence that you can really rely on our products. To make the use of the appliance easier, we attach these comprehensive instruction manual.

The instructions should aid you in getting familiar with your new appliance. Please, read them carefully before using the appliance for the first time.

In any case, please make sure the appliance was supplied to you undamaged. Should you identify and transport damage, contact your sales representative or the regional warehouse from where the product was delivered. You will find the telephone number on the receipt or delivery report.

We wish you a lot of pleasure with your new household appliance.



The appliance for household use for heating food and beverages using electromagnetic energy, for indoor use only.

INSTRUCTIONS FOR USE

These instructions are intended for the user. They describe the cooker and how to use it. They also apply to different types of appliances, therefore you may find some descriptions of functions that may not apply to your appliance.

ENERGY CONSUMPTION

Product information for power consumption and maximum time to reach applicable low power mode.

Off mode	0.8W
----------	------

The maximum time needed for the microwave oven to automatically reach the applicable low power mode or condition.	15 minutes
---	------------

IMPORTANT SAFETY INSTRUCTIONS



Never touch the surfaces of heating or cooking appliances. They will become hot during operation. Keep children at a safe distance. There is a risk of burning!



Microwave energy & High voltage!
Do not remove the cover.

WARNING! The appliance and its accessible parts become hot during use. Care should be taken to avoid touching heating elements. Children less than 8 years of age shall be kept away unless continuously supervised. Children should be supervised to ensure that they do not play with the appliance.

This appliance can be used by children aged from 8 years and above and persons with reduced physical, sensory or mental capabilities or lack of experience and knowledge if they have been given supervision or instruction concerning use of the appliance in a safe way and understand the hazards involved. Children shall not play with the appliance. Cleaning and maintenance shall not be made by children unless they are older than 8 and supervised.

Keep the appliance and its cord out of reach of children less than 8 years.

- **WARNING:** When the appliance is operated in the combination mode, children should only use the oven under adult supervision due to the temperatures generated; (Only for the model with grill function)

- **WARNING:** If the door or door seals are damaged, the oven must not be operated until it has been repaired by a competent person;
- **WARNING:** It is hazardous for anyone other than a competent person to carry out any service or repair operation that involves the removal of a cover which gives protection against exposure to microwave energy;
- **WARNING:** liquids and other foods must not be heated in sealed containers since they are liable to explode.
- Children should be supervised to ensure that they do not play with the appliance.
- Don't remove oven's feet, do not block air vents of the oven.
- Only use utensils that are suitable for use in microwave ovens.
- When heating food in plastic or paper containers, keep an eye on the oven due to the possibility of ignition;
- If smoke is observed, switch off or unplug the appliance and keep the door closed in order to stifle any flames;
- Microwave heating of beverages can result in delayed eruptive boiling, therefore care must be taken when handling the container;
- The contents of feeding bottles and baby food jars shall be stirred or shaken and the temperature checked before consumption, in order to avoid burns;
- Eggs in their shell and whole hard-boiled eggs should not be heated in microwave ovens since they may explode, even after microwave heating has ended;

- When cleaning surfaces of door, door seal, cavity of the oven, use only mild, nonabrasive soaps, or detergents applied with a sponge or soft cloth.
- The oven should be cleaned regularly and any food deposits removed;
- Failure to maintain the oven in a clean condition could lead to deterioration of the surface that could adversely affect the life of the appliance and possibly result in a hazardous situation;
- If the supply cord is damaged, it must be replaced by the manufacturer, its service agent or similarly qualified persons in order to avoid a hazard.
- Do not let the cord hang over the edge of the table or worktop.
- Never connect this appliance to an external timer switch or remote control system in order to avoid a hazardous situation.
- Never replace the light bulb inside the oven. It must always be replaced by Gorenje service.
- Do not clean the appliance with steam cleaners, high-pressure cleaners, sharp objects, abrasive cleaning agents, and abrasive sponges and stain removers.

SAFETY INSTRUCTIONS FOR GENERAL USE

Listed below are, as with all appliances, certain rules to follow and safeguards to assure top performance from this oven:

1. Always have the glass tray, roller arms, coupling and roller track in place when operating the oven.
2. Do not use the oven for any reason other than food preparation, such as for drying clothes, paper, or any other nonfood items, or for sterilizing purposes.
3. Do not operate the oven when empty. This could damage the oven.
4. Do not use the oven cavity for any type of storage, such as papers, cookbooks, etc.
5. Do not cook any food surrounded by a membrane, such as egg yolks, potatoes, chicken livers, etc without first being pierced several times with a fork.
6. Do not insert any object into the openings on the outer case.
7. Do not at any time remove parts from the oven such as the feet, coupling, screws, etc.
8. Do not cook food directly on the glass tray. Place food in/on proper cooking utensil before placing in the oven.

IMPORTANT - COOKWARE NOT TO USE IN YOUR MICROWAVE OVEN

- Do not use metal pans or dishes with metal handles.
 - Do not use anything with metal trim.
 - Do not use paper covered wire twist-ties on plastic bags.
 - Do not use melamine dishes as they contain a material which will absorb microwave energy. This may cause the dishes to crack or char and will slow down the cooking speed.
 - Do not use Centura Tableware. The glaze is not suitable for microwave use. Corelle Livingware closed handle cups should not be used.
 - Do not cook in a container with a restricted opening, such as a pop bottle or sealed oil bottle, as they may explode if heated in a microwave oven.
 - Do not use conventional meat or candy thermometers.
 - There are the thermometers available specifically for microwave cooking. These may be used.
9. Microwave utensils should be used only in accordance with manufacturer's instructions.
 10. Do not attempt to deep-fry foods in this oven.
 11. Please remember that a microwave oven only heats the liquid in a container rather than the container itself.

Therefore, even though the lid of a container is not hot to the touch when removed from the oven, please remember that the food/liquid inside will be releasing the same amount of steam and/or spitting when the lid is removed as in conventional cooking.





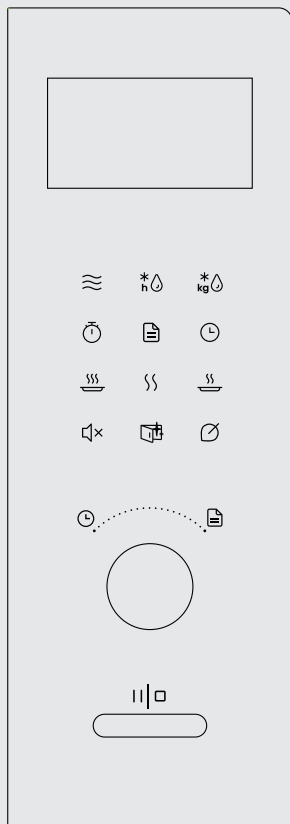







12. Always test the temperature of cooked food yourself especially if you are heating or cooking food/liquid for babies. It is advisable never to consume food/liquid straight from the oven but allow it to stand for a few minutes and stir food/liquid to distribute heat evenly.
13. Food containing a mixture of fat and water, e.g. stock, should stand for 30-60 seconds in the oven after it has been turned off. This is to allow the mixture to settle and to prevent bubbling when a spoon is placed in the food/liquid or a stock cube is added.
14. When preparing/cooking food/liquid and remember that there are certain foods, e.g. Christmas puddings, jam and mincemeat, which heat up very quickly. When heating or cooking foods with a high fat or sugar content do not use plastic containers.
15. Cooking utensil may become hot because of heat transferred from the heated food. This is especially true if plastic wrap has been covering the top and handles of the utensil. Potholders may be needed to handle the utensil.
16. To reduce the risk of fire in the oven cavity:
 - a) Do not overcook food. Carefully attend microwave oven if paper, plastic, or other combustible materials are placed inside the oven to facilitate cooking.
 - b) Remove wire twist-ties from bags before placing bag in oven.
 - c) If materials inside the oven should ignite, keep oven door closed, turn the oven off at the wall switch, or shut off power at the fuse or circuit breaker panel.

CONTROL PANEL



DISPLAY UNIT

Displays the selected functions and time.

	Microwave
	Defrost by time
	Defrost by weight
	Timer
	Menu
	Clock
	Reheat
	softmelt
	Keepwarm
	Mute
	Auto clean
	Eco

KEYS

	Pause / Stop
---	--------------

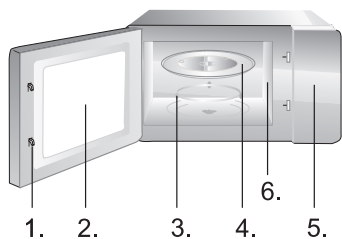

1. Door Safety Lock System
2. Oven Window
3. Roller Ring
4. Glass Tray
5. Control Panel
6. Wave guide (please do not remove the mica plate covering the wave guide)

INSTRUCTIONS FOR USE

BEFORE COOKING

The display lights up when plugged in power supply, then enter the standby state and display shows 1:00.

MICROWAVE FUNCTION

There are five microwave power levels, 100P, 80P, 50P, 30P and 10P, respectively.

In standby mode, turn the knob to select the microwave function, and then press the knob button to confirm.

Turn the knob to select microwave power, press the knob button to confirm, and then enter the cooking time setting.

Turn the knob to select cooking time, and the time range that can be regulated is from 0:10 to 60:00.

After selecting the cooking time, press knob button to start work.

An buzzing sound to notify completion of the operation.

HIGH	100% power output	(Applicable for quick and thorough cooking)
M.High	80% power output	(Applicable for quick and thorough cooking)
Med	50% power output	(Applicable for quick and thorough cooking)
M.Low	30% power output	(Applicable for quick and thorough cooking)
LOW	10% power output	(Applicable for keeping warm)

NOTE:

- The max time which can be set is 60 minutes.
- Never use the grill rack during microwave cooking.
- Never operate the oven empty.
- At the maximum microwave power, the oven will automatically lower the power after a certain time of cooking to lengthen the service life.
- If you turn the food during operation, press the knob button once and the preset cooking procedure will continue.
- If you intend to remove the food before the preset time you must press  button once to clear the preset procedure to avoid unintended operation of next time use.

TIME-BASED DEFROSTING FUNCTION

This function is designed for time-based defrosting, and the specific steps are as follows.

When in standby mode, turn the knob to select the defrosting function, press the knob button to confirm, and then proceed to set the defrosting duration. Turn the knob to select the food defrosting duration, which ranges from 0:10 to 60:00. After selecting the defrost time, press the knob button to start work. An buzzing sound to notify completion of the operation.

WEIGHT-BASED DEFROSTING FUNCTION

This function is designed for weight-based defrosting, and the specific steps are as follows.

When in standby mode, turn the knob to select the weight-based defrosting function, press the knob button to confirm, and then proceed to set the defrosting weight. Turn the knob to select the weight of the food to be defrosted, with a selectable range from 100g to 1500g. After selecting the defrost weight, press the knob button to start work. An buzzing sound to notify completion of the operation. The weight-based defrosting mode will have a beeping sound to prompt the food to be turned over during defrosting.

The following are recommended guidelines for defrosting.

Time-based defrosting mode	For defrosting, the time range from 0:10 to 60:00.
Weight-based defrosting mode	For defrosting, the weight range from 100 to 1500g.

NOTE:

- It is necessary to turn over the food during operation to obtain uniform effect.
- Usually defrosting will need longer time than that of cooking the food.
- If the food can be cut by knife, the defrosting process can be considered completed.
- Microwave penetrates around 4cm into most food
- Defrosted food should be consumed as soon as possible it is not advised to put back to fridge and freeze again.

TIMER

Operating procedure for the countdown function.

When in standby mode, turn the knob to select the timer function, then press the knob button to enter the countdown setting interface. The display screen will show the countdown function icon and display "0:00". Turning the knob can adjust the countdown time, and the maximum time that can be set is 60 minutes. Press the knob button to initiate the countdown, a beep will sound upon completion of the countdown.

AUTO COOKING

There are 16 automatic menu settings, labeled A.1 through A.16, corresponding to the following items: Broccoli Florets, Sliced Carrots, Green Beans, Spinach, Corn on the Cob, Wholemeal Macaroni, Quinoa, Brown Rice, Bread Dough, Breakfast Sausage, Pasta, Pizza, Popcorn, Beverage, Meat, and Fish. The specific operating procedures are outlined below.

When in standby mode, turn the knob to select the desired function, then press the knob button to enter the automatic menu selection interface. Turn the knob to select the desired automatic menu, the display screen will show the corresponding code from A.1 to A.16. Then press the knob button to confirm. Turn the knob to select the desired portion size of the food, and the display screen will automatically update to reflect the selected portion size. After selecting the cooking weight, press the knob button to start work. An buzzing sound to notify completion of the operation.

Display	Kind	Size	Operation
A.1	Broccoli Florets	200g	Wash the broccoli, cut it into uniform small pieces, add 60 ml (4 tablespoons) of water and a pinch of salt, cover with a lid or microwave-safe plastic wrap perforated with holes, and place the container in the center of the glass turntable tray.
A.2	Sliced Carrots	200g	Peel and clean the carrots, cut them into thin slices approximately 1 cm thick, add 30 ml (2 tablespoons) of water and a pinch of salt, cover with a lid or microwave-safe plastic wrap perforated with holes, and place the container in the center of the glass turntable tray.
A.3	Green Beans	200g	Rinse and clean the green beans, add 30 ml (2 tablespoons) of water and a pinch of salt, cover with a lid or microwave-safe plastic wrap perforated with holes, place the container in the center of the glass turntable tray, and stir after cooking.
A.4	Spinach	200g	Wash and rinse the spinach, add 30 ml (2 tablespoons) of water and a pinch of salt, cover with a lid or microwave-safe plastic wrap perforated with holes, place the container in the center of the glass turntable tray, stir after cooking, and allow it to rest for 2-3 minutes.
A.5	Corn on the Cob	200g	Clean the corn on the cob, add 30 ml (2 tablespoons) of water and a pinch of salt, cover with a lid or microwave-safe plastic wrap perforated with holes, place the container in the center of the glass turntable tray, and stir after cooking.

A.6	Wholemeal Macaroni	100g	Add six times the volume of room temperature water, incorporate a small amount of salt, and stir thoroughly. Boil uncovered. Upon completion of cooking, stir again and allow the mixture to rest for 1 to 3 minutes.
A.7	Quinoa	100g	Add 2.5 times the volume of room temperature water, cover the container, and cook. Upon completion of cooking, stir the contents, season to taste, cover again, and allow the mixture to rest for 2 to 3 minutes.
A.8	Brown Rice	100g	Soak brown rice in three times its volume of cold water for 3 to 4 hours in advance. Place the soaked rice in a microwave-safe container with a lid. Cover and cook. After cooking, season to taste, stir thoroughly, cover again, and allow the mixture to rest for 5 minutes.
A.9	Bread Dough	375g	<p>Recipe: 250 g flour, 2.5 g yeast, 130 - 140 g water (warm water at 40°C).</p> <ol style="list-style-type: none"> 1. Dissolve the yeast in warm water, stir thoroughly, and allow it to stand for 5 minutes. 2. Gradually incorporate the activated yeast mixture into the flour, kneading until no dry flour remains, then continue kneading until the dough is smooth and cohesive. 3. Transfer the dough evenly into a microwave-safe container, ensuring that the total volume of the contents occupies 50% to 70% of the container's capacity. Cover with plastic wrap. 4. Place a 200 ml bowl of room-temperature water inside the microwave and activate the first power level. 5. Upon completion of the first stage insert the dough container and initiate the second heating phase.
A.10	Breakfast Sausage	200g	Place the sausage in a ceramic dish, cover it with a perforated lid or wrap with plastic wrap and puncture small holes for ventilation. Position the dish in the center of the glass turntable tray and remove from heat once cooking is complete. Serve immediately.

A.11	Pasta	100g	Add eight times the volume of room temperature water, incorporate a small amount of salt, and stir thoroughly. Boil uncovered. Upon completion of cooking, proceed as required.
A.12	Pizza	200g	The initial temperature is -18°C . Place the items on a flat tray or pizza paper, arranging them in a single layer without stacking, and do not cover with plastic wrap.
A.13	Popcorn	100g	Follow the instructions provided on the packaging.
A.14	Beverage	1 cup	Pour milk, coffee, or tea (approximately 250 ml) into a mug and place it in the center of the glass turntable tray.
A.15	Meat	200g	Wash the chicken breast thoroughly and make shallow cuts on the surface. Marinate according to taste. Place it on a ceramic plate, cover with a lid or plastic wrap, puncture several ventilation holes, and position in the center of the glass turntable tray.
A.16	Fish	200g	Wash the fish thoroughly, cut it into portions approximately 2 to 2.5 cm thick, or make several shallow incisions on the surface if left whole. Marinate according to taste, place on a ceramic plate, cover with a lid or plastic wrap, puncture small ventilation holes, and position in the center of the glass turntable tray.

NOTE:

- a. The temperature of food before cooking would be 20- 25 C. Higher or lower temperature of the food before cooking would require increase or decrease of cooking time.
- b. The temperature, weight and shape of food will largely influence the cooking effect. If any deviation has been found to the factor noted on above menu, you can adjust the cooking time for best result.

CLOCK (24-hour clock)

In standby mode, turn the knob to select the clock setting function, and then press the knob button to enter the clock setting interface. At the same time, the display screen blinks in hours. The hour time can be set by turning the knob. After setting the hour, short press the knob button to confirm and switch to the setting minute mode. The minutes can be set by turning the knob. After setting minutes, short press the knob button again to confirm and exit the clock setting mode.

REHEAT

The Reheat function is designed to enable users to reheat food based on its weight. The specific operating procedure is as follows.

When in standby mode, turn the knob to select the Reheat function, then press the knob button to confirm the selection. Turn the knob to select the appropriate food weight. The available weight options are 200g, 400g, 600g, 800g, and 1000g. After selecting the weight, press the knob button to start work, an buzzing sound to notify completion of the operation.

MELT/SOFTEN

When in standby mode, turn the knob to select the Melt/Soften function, then press the knob button to enter the Melt/Soften menu for selection.

Turn the knob to select the corresponding menu, the display screen will show "So-1 (Melt)" or "So-2 (Soften)" accordingly. Then press the knob button to confirm. Turn the knob to select the appropriate food weight, available options range up to 200g. After selecting the weight, press the knob button to start work, an buzzing sound to notify completion of the operation.

Display	Kind	size	Operation
So-1	Melt butter	200g	Place the butter in a heat-resistant container and cover it with a perforated lid or wrap with plastic wrap, puncturing small holes for ventilation.
So-2	Soften butter	200g	Place the butter in a heat-resistant vessel without a lid and turn it over halfway through heating.

KEEP WARM

The operating procedure for the keep warm function is as follows. When in standby mode, turn the knob to select the keep warm function, then press the knob button to confirm the selection. Turn the knob to select the desired time setting (15:00, 30:00, 45:00, or 60:00). After selecting the cooking time, press the knob button to start work, an buzzing sound to notify completion of the operation.

MUTE

The mute function can be activated by following the steps outlined below.

In standby mode, turn the knob to select the desired function, then press the knob button to access the buzzer sound settings. Turn the knob to select whether to enable or disable the buzzer sound, then press the knob button to confirm. The corresponding buzzer sound will accordingly be activated or deactivated.

AUTO CLEAN

Auto Clean is an automated cleaning function designed to assist users in efficiently cleaning the oven cavity. The specific procedure is as follows.

When in standby mode, turn the knob to select this function, press the knob button to confirm the selection, and put 250ml of water (in a vessel) into the cavity. Press the knob button to start work, an buzzing sound to notify completion of the operation. Once the function has been completed and the machine has cooled down, it may be wiped clean with a cloth.

ECO

The ECO function, which activates an energy-saving mode, operates as follows.

When in standby mode, turn the knob to select the desired function, then press the knob button to enter ECO mode, the display screen will subsequently turn off. In ECO mode, press any button to deactivate the ECO function and restore the display.

STOP

In the process of cooking settings, can press "|||■" button to cancel the settings and return to standby mode. During the operation of the microwave oven, can press "|||■" button to pause it. In the paused state, can press "|||■" button again to cancel the function and return to standby mode.

KNOB BUTTON

After setting the cooking time or food weight, press this button to start microwave oven immediately. In working state, can press this button to increase time, press one time to increase 30 seconds, but the menu mode and weight defrosting mode cannot adjust time. In the paused state, can press this button to continue the microwave oven before cooking mode.

EXPRESS COOK

In standby mode, after putting food in and closing the door, press the knob button to start the microwave quickly. The default working time is 30 seconds. In the working process, press the knob button once for 30 seconds. An buzzing sound to notify completion of the operation.

CHILD LOCK FUNCTION

Use this feature to lock the control panel when you are cleaning or so that children cannot use the oven unsupervised. All the buttons (except the "|||■" button) are rendered inoperable in this mode.

1) Set lock: In standby mode, press and hold down the "|||■" button for more than 3 seconds, the child lock function is activated, and all buttons of the microwave oven cannot be operated except the "|||■" button.

2) Cancel lock: In the child lock state, press and hold down the "|||■" button for more than 3 seconds to cancel the child lock function. All the buttons on the microwave oven have been restored to normal functionality.

CARE OF YOUR MICROWAVE OVEN

1. Turn the oven off and remove the power plug from the wall socket before cleaning.
2. Keep the inside of the oven clean. When food splatters of spilled liquids adhere to oven walls, wipe with a damp cloth. The use of harsh detergent or abrasives is not recommended.
3. The outside oven surface should be cleaned with a damp cloth. To prevent damage to the operating parts inside the oven, water should not be allowed to seep into the ventilation openings.
4. Do not allow the Control Panel to become wet. Clean with a soft, damp cloth. Do not use detergents, abrasives or spray-on cleaners on the control Panel.
5. If steam accumulates inside or around the outside of the oven door, wipe with a soft cloth. This may occur when the microwave oven is operated under high humidity conditions and in no way indicates malfunction of the unit.
6. It is occasionally necessary to remove the glass tray for cleaning. Wash the tray in warm sudsy water or in a dishwasher.
7. The roller ring and oven cavity floor should be cleaned regularly to avoid excessive noise. Simply wipe the bottom surface of the oven with mild detergent, water or window cleaner and dry. The roller ring may be washed in mild sudsy water or dishwasher. Cooking vapours collect during repeated use but in no way affect the bottom surface or roller ring wheels. When removing the roller ring from cavity floor for cleaning, be sure to replace it in the proper position.
8. Remove odors from your oven by combining a cup of water with the juice and skin of one lemon in a deep microwavable bowl. Microwave for 5 minutes, wipe thoroughly and dry with a soft cloth.

ENVIRONMENT

Do not throw away the appliance with the normal household waste at the end of its life, but hand it in at an official collection point for recycling. By doing this, you help to preserve the environment.

MOUNTING THE MICROWAVE OVEN

INSTALLATION

1. Make sure all the packing materials are removed from the inside of the door.
2. Inspect the oven after unpacking for any visual damage such as:
 - Misaligned Door
 - Damaged Door
 - Dents or Holes in Door Window and Screen
 - Dents in CavityIf any of the above are visible, DO NOT use the oven.
3. This Microwave Oven weighs 8.9 kg and must be placed on a horizontal surface strong enough to support this weight.
4. The oven must be placed away from high temperature and steam.
5. DO NOT place anything on top of the oven.
6. Keep the oven at least 20 cm away from both sidewalls and 30 cm away from rear wall to ensure the correct ventilation.
7. DO NOT remove the turn -table drive shaft.
8. As with any appliance, close supervision is necessary when used by children.
9. Make sure that the AC outlet is easily accessible so that the plug can be removed quickly in an emergency. Otherwise, it should be possible to disconnect the device using a switch from the circuit. In this case, the existing provisions of the electrical safety standards are considered.

The product has to be correctly installed on earthed socket with a single-phase AC (220-240 V/50 Hz). **WARNING! THIS APPLIANCE MUST BE EARTHED!**
10. This oven requires 1.3 KVA for its input consultation with service engineer is suggested when installing the oven.

CAUTION: This oven is protected internally by a 250V, 8 Amp Fuse.

SPECIFICATIONS

Power consumption.....	220-240V-50Hz, 1280W
Output power	800W
Operating Frequency	2450MHz
Outside Dimensions.....	480mm(W)x292.5mm(H) x364mm(D)
Oven Capacity	23 litres
Uncrated Weight	Approx. 8.9 kg
Noise level.....	Lc < 58 dB (A)



This appliance is marked according to the European directive 2012/19/EU on Waste Electrical and Electronic Equipment (WEEE).

This guideline is the frame of a European-wide validity of return and recycling on Waste Electrical and Electronic Equipment.

MOUNTING DIMENSIONS

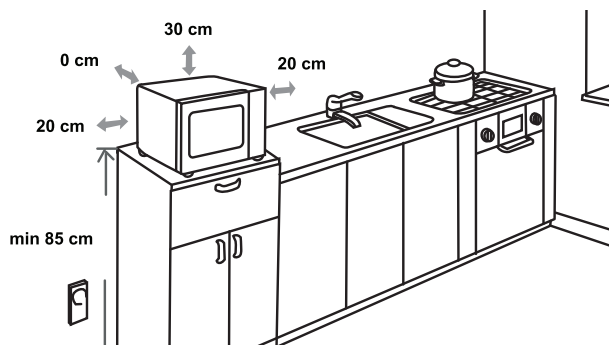

RADIO INTERFERENCE

Microwave oven may cause interference to your radio, TV, or similar equipment. When interference occurs, it may be eliminated or reduced by the following procedures.

- Clean the door and sealing surface of the oven.
- Place the radio, TV, etc. as far away from your microwave oven as possible.
- Use a properly installed antenna for your radio, TV, etc. to get a strong signal reception.

WE RESERVE THE RIGHT TO MAKE ANY CHANGES THAT DO NOT AFFECT THE FUNCTIONALITY OF THE APPLIANCE.

BEFORE YOU CALL FOR SERVICE

1. If the oven will not perform at all, the information on the display does not appear or the display disappeared:
 - a) Check to ensure that the oven is plugged in securely. If it is not, remove the plug from the outlet, wait 10 seconds and plug it in again securely.
 - b) Check the premises for a blown circuit fuse or a tripped main circuit breaker. If these seem to be operating properly, test the outlet with another appliance.
2. If the microwave power will not function:
 - a) Check to see whether the timer is set.
 - b) Check to make sure that the door is securely closed to engage the safety interlocks. Otherwise, the microwave energy will not flow into the oven.

If none of the above rectify the situation, then contact the nearest authorized service agent.

The appliance for household use for heating food and beverages using electromagnetic energy, for indoor use only.

GUARANTEE & SERVICE

If you need information or if you have a problem, please contact the Gorenje Customer Care Centre in your country (you find its phone number in the worldwide guarantee leaflet). If there is no Customer Care Centre in your country, go to your local Gorenje dealer or contact the Service department of Gorenje domestic appliances.

For personal use only!

Additional recommendations for cooking with microwave and useful advices can be found on web side:

<http://www.gorenje.com>

WISHES YOU A LOT OF PLEASURE WHILE USING YOUR APPLIANCE

gorenje

www.gorenje.com