

SUMMIT

2.7 CU. FT. 26LBS. WASHER

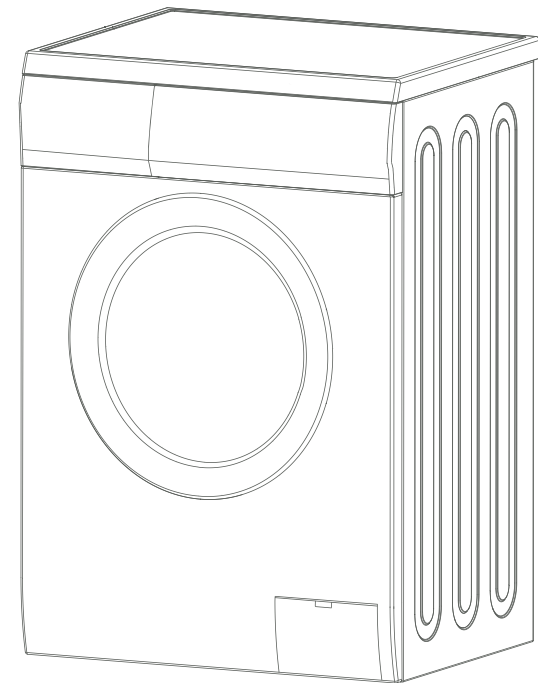

**USER MANUAL
MODEL LW2427**

FELIX STORCH, INC.
An ISO 9001:2015 registered company
770 Garrison Avenue
Bronx, New York 10474
www.summitappliance.com

Contents

Contents

Safety And Precautions.....	2
Safety and precautions.....	2
Important safety instructions.....	3
Grounding instructions.....	6
Before operating this machine.....	6
Attention shall be paid to protecting the machine.....	6
Cautions during handling machine.....	6
Cautions when washing clothes.....	7
Installation Requirements.....	8
Tools and parts.....	8
Location requirements.....	9
Installation clearances.....	9
Electrical requirements.....	9
Washer dimensions.....	10
Unpacking the washing machine.....	10
Installation Instructions.....	11
Dispose the packing materials.....	11
Remove transport bolts and foam.....	11
Select the location.....	11
Install inlet pipe.....	12
Drain system options.....	12
Level the washer.....	13
Electrical connection.....	13
Operating Instructions.....	14
Checklist and preparation before washing clothes.....	14
View of control panel.....	18
Washing clothes at first time.....	22
Select the procedure.....	22
Table of washing procedures.....	24
Care And Cleaning	25
Troubleshooting Tips.....	29
Remove The Problems.....	30
Appendix.....	31
Technical Specifications.....	32

Safety And Precautions

Safety and precautions

This manual contains important information on the installation, use, and care of your appliance. Please read this manual carefully before installation and operation of this machine to prevent injury and property damage.

WHAT YOU NEED TO KNOW ABOUT SAFETY INSTRUCTIONS

Warnings and Important Safety Instructions in this manual DO NOT cover all possible conditions and situations that may occur. It is your responsibility to use common sense, caution and care when installing, maintaining and operating your washer.

IMPORTANT SAFETY SYMBOLS AND PRECAUTIONS



WARNING

This indicates that hazards or unsafe practices may cause **serious personal injury or death**. To reduce the risk of fire, explosion, electric shock, or personal injury when using your washer, these basic safety precautions **SHOULD** be followed.

State of California Proposition 65 Warnings



WARNING

The California Safe Drinking Water and Toxic Enforcement Act requires the Governor of California to publish a list of substances known to the State of California to cause cancer, birth defects, or other reproductive harm, and requires business to warn of potential exposure to such substances. This product contains a chemical known to the State of California to cause cancer, birth defects, or other reproductive harm. This appliance can cause low-level exposure to some of the substances listed, including benzene, formaldehyde, and carbon monoxide.

Safety And Precautions

Important safety instructions

SAVE THESE INSTRUCTIONS



- WARNING - To reduce the risk of fire, electric shock, or injury to persons when using your appliance, follow basic precautions, including the following:
- Read all instructions before using the appliance.
 - Do not wash articles that have been previously cleaned in, washed in, soaked in, or spotted with gasoline, dry-cleaning solvents, or other flammable or explosive substances, as they give off vapours that could ignite or explode.
 - Do not add gasoline, dry-cleaning solvents, or other flammable or explosive substances to the wash water. These substances give off vapours that could ignite or explode.
 - Under certain conditions, hydrogen gas may be produced in a hot-water system that has not been used for 2 weeks or more. **HYDROGEN GAS IS EXPLOSIVE.** If the hot-water system has not been used for such a period, before using a washing machine, turn on all hot-water faucets and let the water flow from each for several minutes. This will release any accumulated hydrogen gas. As the gas is flammable, do not smoke or use an open flame during this time.
 - Always unplug the washing machine from the power supply before attempting any service. Disconnect the power cord by grasping the plug, not the cord.
 - To reduce the risk of fire, clothes, cleaning rags, mop heads and the like which have traces of any flammable substance, such as vegetable oil, cooking oil, petroleum based oils or distillates, waxes, fats, ect., must not be placed in the washing machine. These items may contain flammable substances which, even after washing, may smoke or catch fire.
 - Never place items in the washer that have been dampened with gasoline or any combustible or explosive substance. Do not wash or dry anything that has been soaked in or spotted with any type of oil (including cooking oils). Doing so can result in fire, explosion, or death.
 - Do not allow children to play on or in the appliance. Close supervision of children is necessary when the appliance is used near children.
 - Pets and kids may climb into the machine. Check the machine before every operation.
 - Glass door or protector may be very hot during the operation. Keep kids and pets far away from the machine during the operation.
 - This machine is not intended for use by persons (including kids) with reduced physical, sensory or mental capabilities, or lack of experience and knowledge, unless they have been given supervision or instruction concerning use of the machine by a person responsible for their safety.
 - Kids should be supervised to ensure that they do not play with the machine.
 - When children become old enough to operate the appliance, it is legal responsibility of the parents or legal guardians to ensure that they are instructed in safe practices by qualified persons.

Safety And Precautions

Important safety instructions

SAVE THESE INSTRUCTIONS



- Do not machine wash fiberglass materials (such as curtains and window coverings that use fiberglass materials.) Small particles may remain in the washing machine and stick to fabrics in subsequent wash loads causing skin irritation.
- Before the appliance is removed from service or discarded, remove the door and cut off the power cord.
- Do not reach into the appliance if the tub or agitator is moving.
- Do not install or store this appliance where it will be exposed to the weather.
- Do not tamper with controls.
- Do not repair or replace any part of the appliance or attempt any servicing unless specifically recommended in the user-maintenance instructions or in published user-repair instructions that you understand and have the skills to carry out.
- Never stop a tumble dryer before the end of the program and spread out so that the heat is dissipated.
- Pull out its plug from the power socket before cleaning or maintenance.
- Make sure that all pockets are emptied.
- Sharp and rigid items such as coin, brooch, nail, screw or stone etc. may cause serious damages to this machine.
- Pull out its plug and cut off water supply after the operation.
- Please check whether the water inside the drum has been drained before opening its door. Please do not open the door if there is any water visible.
- Do not try to repair the machine by yourself. The machine may be damaged or more troublesome repair work may be caused and even dangerous operation may take place if it is repaired by any inexperienced or unqualified staff.
- If the plug (power cord) is damaged, it shall be replaced by the manufacturer or a service agent to avoid any danger.
- Take care that power voltage and frequency shall be identical to those of washing machine.
- Do not use any socket with rated current less than that of washing machine. Never pull out power plug with wet hand.
- To ensure your safety, power cord plug must be inserted into an earthed three-pole socket. Check carefully and make sure that your socket is properly and reliably earthed.
- This machine shall be repaired only by an authorized service center and only authentic accessories can be used.
- An appliance shall be clearly and permanently marked with a warning that the appliance is intended for use only with fabrics that have been washed with water as a cleaning agent.
- To reduce the risk of fire, do not dry articles containing foam rubber or similarly textured rubber like materials.

Safety And Precautions

Important safety instructions

SAVE THESE INSTRUCTIONS



- If connected to a circuit protected by fuses, use time-delay fuses with this appliance.
- Do not dry articles that have been previously cleaned in, washed in, soaked in, or spotted with gasoline, dry-cleaning solvents, or other flammable or explosive substances, as they give off vapours that could ignite or explode.
- Do not use fabric softeners or products to eliminate static unless recommended by the manufacturer of the fabric softener or product.
- Do not use heat to dry articles containing foam rubber or similarly textured rubber-like materials. The interior of the appliance should be cleaned periodically by qualified service personnel.
- Do not place items exposed to cooking oils in your dryer. Items contaminated with cooking oils may contribute to a chemical reaction that could cause a load to catch fire.

Safety And Precautions

Grounding instructions



- This appliance must be grounded. In the event of a malfunction or breakdown, grounding will reduce the risk of electric shock by providing a path of least resistance for the electric current. This appliance is equipped with a cord that has an equipment grounding conductor and a grounding plug. The plug must be plugged into an appropriate outlet that is properly installed and grounded in accordance with all local codes and ordinances.
- **WARNING**-Improper connection of the equipment grounding conductor can result in electric shock. Connect to individual branch Circuit. Check with a qualified electrician or serviceman if you are in doubt as to whether the washer is properly grounded.
- **DO NOT** modify the plug provided with the appliance if it will not fit the outlet. Please have a proper outlet installed by a proper outlet installed by a qualified electrician.

Before operating this machine



- Packing materials may be dangerous to the kids. Please keep all packing materials (plastic bags, foams etc) far away from the kids.
- Washing machine shall not be installed in bath room or very wet rooms as well as in the rooms with explosive or caustic gases.
- Make sure that the water and electrical devices must be connected by a qualified technician in accordance with the manufacturer's instructions and local safety regulations.
- Before operating this machine, all packages and transport bolts must be removed. Otherwise, the washing machine may be seriously damaged while washing the clothes.
- Before washing the clothes at first time, the washing machine shall be operated in cotton and hot water procedures without the clothes inside.
- This washing machine is for indoor use only.

Attention shall be paid to protecting the machine



- Do not climb up and sit on top cover of the machine.
- Do not lean against machine door.
- Please do not close the door with excessive forces. If it is found difficult to close the door, please check if the excessive clothes are put in or distributed well.

Cautions during Handling Machine



- Transport bolts shall be reinstalled to the machine by a specialized person.
- The accumulated water shall be drained out of the machine.
- Handle the machine carefully. Never hold each protruded part on the machine while lifting.
- Machine door can not be used as the handle during the conveyance.

Safety And Precautions

Cautions when washing clothes



- Cold city water shall be used and hot water may be also connected according to the local situations.
- Your washing machine is only for home use and is only designed for the textiles suitable for machine washing.
- Flammable and explosive or toxic solvents are forbidden. Gasoline and alcohol etc. shall not be used as detergents. Please only select the detergents suitable for machine washing, especially for front loading .
- It is forbidden to wash carpets.
- Be careful of burning when washing machine drains hot washing water.
- Never refill the water by hand during washing.
- After the program is completed, please open the door after the bell or disconnect the power supply to the machine.
- Please remember to disconnect water and power supply immediately after the clothes are washed.
- Always follow the fabric care instructions recommended by the clothing manufacturer.
- Do not use the washing machine if it has a worn power cord or loose plug. Contact an authorized service agent.
- Do not operate the washing machine if any guards, panels and /or fasteners except transport fixing bolts have been removed. Check the fill hose connections on a regular basis to ensure that they are tight and not leaking.
- Do not operate the washing machine if parts are missing or broken.
- Do not touch the door if washing at high temperatures.

Note;

- The Important Safeguards and Warnings indicated in this manual do not cover all possible conditions which may occur. Common sense, caution and care must be exercised when installing, maintaining or operating the washing machine.
- Always contact your dealer, distribute, service agent or the manufacturer about any problems or conditions that you do not understand.

Installation Requirements

Installation requirements



- 1.This machine must be earthed properly. If there is any short circuit, earthing can reduce the danger of electrical shock.
This machine is equipped with power cord, which includes plug, earthing wire at earthing terminal.
- 2.Washing machine shall be operated in a circuit separate from other electrical appliances. Otherwise, power protector may be tripped or fuse may be burned out.

WARNING – Risk of Fire

Clothes dryer installation must be performed by a qualified installer. Install the clothes dryer according to the manufacturer's instructions and local codes. These conditions will obstruct clothes dryer airflow and increase the risk of fire. To reduce the risk of severe injury or death, follow all installation instructions. Save these instructions.

Failure to comply with these warnings could result in serious personal injuries.

Note:Environmental Protection

- If you plan to dispose this machine, please comply with the local waste disposal regulations. Cut off the power cord so that it will not be put into reuse. Remove the door so that kids and animals will not be trapped in the machine.
- Do not use excessive detergents.
- Decontaminant and bleach can be used to pre-treat the stains on the clothes only when very necessary.

Tools and parts

Gather the required tools and parts before starting installation. The parts supplied are in the washer drum.

1/4" nut driver 3/8" socket with ratchet
3/8" open-end wrench
Adjustable wrench or 7/16" socket with ratchet
Adjustable wrench or 9/16" open-end wrench
Channel-lock adjustable pliers
Carpenter's level

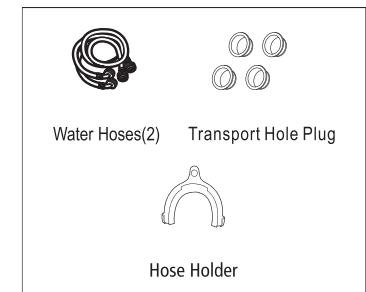

Installation Requirements

Location requirements

Selecting the proper location for your washer improves performance and minimizes noise and possible washer “walk.” Your washer can be installed under a custom counter, or in a basement, laundry room, closet, or recessed area. See “Drain System.” Companion appliance location requirements should also be considered. Proper installation is your responsibility.

You will need

1. A water heater set to deliver 120° F (49° C) water to the washer.
2. A grounded electrical outlet located within 6 ft. (1.8 m) of where the power cord is attached to the back of the washer. See “Electrical Requirements.”
3. Hot and cold water faucets located within 4 ft. (1.2 m) of the hot and cold water fill valves, and water pressure of 20–100 psi (137.9–689.6 kPa).
4. A level floor with a maximum slope of 1" (25 mm) under entire washer. Installing the washer on soft floor surfaces, such as carpets or surfaces with foam backing, is not recommended.
5. A sturdy and solid floor to support the washer with a total weight (water and load) of 200 lbs.
6. Do not operate your washer in temperatures below 32° F (0° C). Some water can remain in the washer and can cause damage in low temperatures.

Installation clearances

1. The location must be large enough to allow the washer door to be fully opened.
2. Additional spacing should be considered for ease of installation and servicing. The door opens more than 90°, and it is not reversible.
3. Additional clearances might be required for wall, door, and floor moldings.
4. Additional spacing of 25 mm on all sides of the washer is recommended to reduce noise transfer.
5. Companion appliance spacing should also be considered.

Electrical requirements

⚠ WARNING



Electrical Shock Hazard

Connect to grounded 3 prong outlet with an individual 12 amp branch circuit protected by a 12 amp circuit breaker.
Connect to individual branch circuit.
Do not remove ground prong.
Do not use an adapter.
Do not use an extension cord.
Failure to follow these instructions can result in electrical shock, fire, or death.

Installation Requirements

Electrical requirements

1. A 120v, 60Hz, AC only, 15- or 20 amp, fused electrical supply is required. A time-delay fuse or circuit serving only this appliance be provided.
2. This washer is equipped with a power supply cord having a 3 prong grounding plug.
3. To minimize possible shock hazard, the cord must be plugged into a mating, 3 prong, grounding type outlet, grounded in accordance with local codes and ordinances. If a mating outlet is not available, it is the personal responsibility and obligation of the customer to have the properly grounded outlet installed by a qualified electrician.
4. If codes permit and a separate ground wire is used, it is recommended that a qualified electrician determine that the ground path is adequate.
5. Do not ground to a gas pipe.
6. Check with a qualified electrician if you are not sure the washer is properly grounded.
7. Do not have a fuse in the neutral or ground circuit.

Washer dimensions

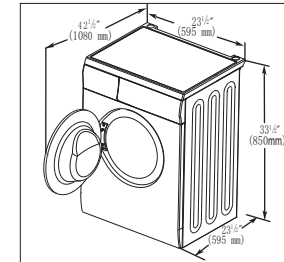

The dimensions shown are for the recommended spacing. Custom dercounter installation

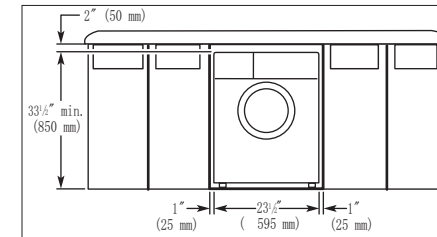

Unpacking the washing machine

Unpack your washing machine and check if there is any damage during the transportation. Also make sure that all the items (as shown in Page 5) in the attached bag are received. If there is any damage to the washing machine during the transportation, or any item is missing, please contact the local dealer immediately.

Installation Instructions

Dispose the packing materials

The packing materials of this machine may be dangerous to kids. Please dispose them properly and avoid easy touch by kids. Please dispose the related packing materials according to the relevant local regulations. Please do not throw the packing materials away together with the other daily living rubbishes.

Remove transport bolts and foam

Before using this washing machine, transport bolts must be removed from the backside of this machine. Please take the following steps to remove the bolts:

1. Loosen all bolts with spanner and then remove them.
2. Cover the holes with transport hole plugs.
3. Keep the transport bolts properly for future use.

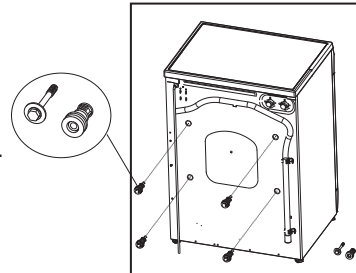

Make sure the small triangle foam is removed with the bottom one together. If not, lay the unit down with side surface, then remove the small foam from the unit bottom manually.

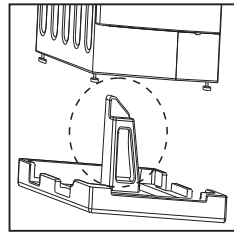

Select the location

Before installing the washing machine, the location characterized as follows shall be selected:

- Rigid, dry, and level surface (if not level, please make it level with reference to the following figure "Adjust Leg")
- Avoid direct sunlight
- Sufficient ventilation
- Room temperature is above 0°C
- Keep far away from the heat resources such as coal or gas.

Make sure that the washing machine will not stand on power cord.

Do not install the washing machine on the carpet floor.

Connect inlet pipe

Connect the inlet pipe as indicated in the figure. For the model which has hot valve, please connect the hot valve to hot water tap.

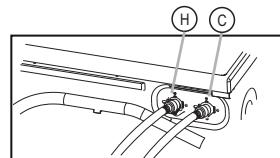

Installation Instructions

Install inlet pipe

1. Connect the elbow to tap and fasten it clockwise.
2. Connect the other end of inlet pipe to the inlet valve at the backside of washing machine and fasten the pipe tightly clockwise.

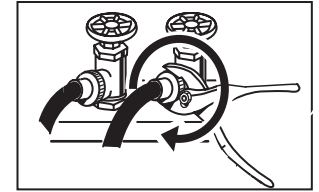

Note: after connection, if there is any leakage with hose, then repeat the steps to connect inlet pipe. The most common type of tap shall be used to supply water. If tap is square or too big, then standard tap shall be changed.

Drain system options

Standpipe drain system – wall or floor (views A & B)
The standpipe drain requires a minimum diameter standpipe of 2" (50 mm). The minimum carry-away

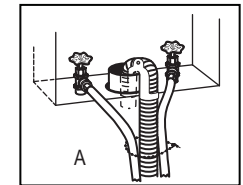

Capacity can be no less than 17 gal. (64 L) per minute. The top of the standpipe must be at least 60cm high and no higher than 100cm from the bottom of the washer.

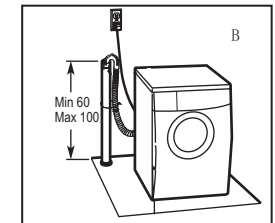

Laundry tub drain system (view C)

The laundry tub needs a minimum 20 gal. (76 L) capacity. The top of the laundry tub must be at least 60cm above the floor.

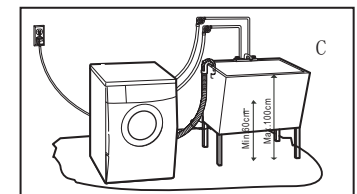

Floor drain system (view D). The floor drain system requires a siphon break that may be purchased separately. See "Tools and Parts". The siphon break must be a minimum of 28" (710 mm) from the bottom of the washer. Additional hoses might be needed.

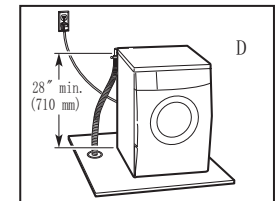

Installation Instructions

Level the washer

1. When positioning the washing machine, please first check if the legs are closely attached to the cabinet. If not, please turn them to their original positions with hand or spanner and tighten the nuts with spanner.
2. After positioning the washing machine, press four corners on top cover of washing machine in sequence. If the washing machine is not stable when being pressed, this leg shall be adjusted.

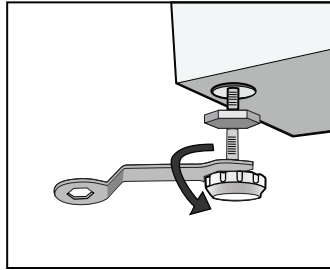

3. Ensure the positioning status of washing machine. Loosen the lock nut with spanner and turn the leg with hand until it closely contacts with the floor. Press the leg with one hand and fasten the nut closely to the cabinet with the other hand.

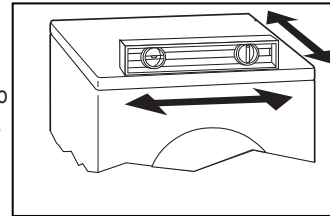

4. After being locked properly, press four corners again to make sure that they have been adjusted properly. If it is still unstable, it has to repeat Steps 2 and 3.
5. Put a solid cylinder (e.g. pop cans) oppositely on the top cover of the washing machine from the left, right, front and back directions. If the cylinder keeps stable, the washing machine is positioned level. If it rolls, the washing machine is positioned unlevel. The rolling direction is the direction of lower ground surface. Then the two legs in this direction shall be raised at the same time until the washing machine is level. Steps 1~3 are repeated to make the bottom legs closely against the ground and the nuts shall be locked tightly.

Electrical connection

- As the maximum current through the unit is 12A when you are using its heating function, please make sure the power supply system (current, power voltage and wire) at your home can meet the normal loading requirements of the electrical appliances.
- Please connect the power to a socket which is correctly installed and properly earthed.
- Make sure the power voltage at your place is same to that in the machine's rating label.
- Power plug must match the socket and cabinet must be properly and effectively earthed.
- Do not use multi-purpose plug or socket as extension cord.
- Do not connect and pull out plug with wet hand.
- When connecting and pulling out the plug, hold the plug tightly and then pull it out. Do not pull power cord forcibly.
- If power cord is damaged or has any sign of being broken, special power cord must be selected or purchased from its manufacturer or service center for replacement.

Operating Instructions

Operating instructions



WARNING – To reduce the risk of fire, electric shock, or injury to persons, read the IMPORTANT SAFETY INSTRUCTIONS before operating this appliance.

Checklist and preparation before washing clothes

Please read this operation method carefully to avoid the troubles of washing machine and damages of clothes.

Check if the first-washed clothes will be decolorized.

After a white towel touched with liquid detergent is used to wash the invisible corners of the clothes, check if the white towel is stained with clothes' original color.

As for the scarves and those clothes that easily get decolorized among imported clothes, please wash them separately before washing. As for the stains on sleeves, collars and pockets, use the liquid detergent and wash it with brush gently. Finally put them into the washing machine to achieve more ideal washing effects.

As for temperature-sensitive clothes, they shall be washed as required in the labels. Otherwise, it may cause color change or distortion.

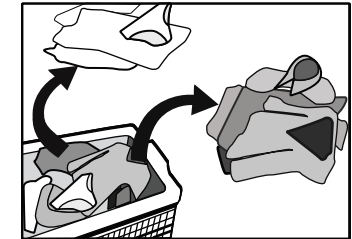

Keep in Mind:

Never put the clothes to be washed in washing machine for a long period of time. Otherwise it may get moldy and cause spots. Therefore, please wash the clothes in time. The clothes also may get color changed or distorted if they are not washed according to the stated washing temperature.

Clothes that can not be washed by washing machine

The clothes that may get distorted if being immersed in water: Ties, waistcoats, western-style clothes, outer garments etc. may have obvious shrinkage if being immersed in water; the decolorized clothes such as blended spinning clothes of artificial fiber etc.

Operating Instructions

Checklist and preparation before washing clothes

Wrinkle-style clothes, embossed clothes, resin clothes etc. may get distorted when being immersed in water. Among cotton and wool materials, the clothes that get easily distorted are wrinkle-style silk, fur products and fur decorations;

Clothes with decoration, long dress and traditional clothes etc are the products to get decolorized easily.

Please do not wash the clothes without material labels and washing requirements.

Never wash the clothes stained with the chemicals such as gasoline, petroleum, benzene, paint thinner and alcohol.

Please pay attention with regard to detergents

"Low bubble" detergent or washing powder or washing powder special for drum washing machine shall be selected according to fiber types (cotton, synthetic fiber, soft products and wool products), colors, washing temperatures, dirty degrees and types. Otherwise, excessive bubbles may be generated and overflowed out of the drawer so that accidents may take place.

Bleacher belongs to alkali type and can damage clothes, so it is suggested to use as little as possible.

Powder detergents can easily leave the residues in the clothes so as to generate the bad smell, so they shall be sufficiently rinsed.

Detergent can not easily get dissolved completely if there is too much detergent or water temperature is rather low. It can remain in clothes, pipes and washing machines to pollute the clothes.

Washing shall follow the weight of clothes, dirty degrees, local water hardness as well as the recommendations from the detergent manufacturers. Please consult the water company if you are not clear of water hardness.

Note:

Keep detergents and additives in safe and dry places out of touch by kids.

Please take out the items out of the pockets.

Please check the pockets of the clothes to be washed, empty the rigid items such as decorations and coins, otherwise washing machine may be damaged or have abnormal troubles.

For the clothes to be washed, they are classified according to the following characteristics:

The symbol types of care labels: the clothes to be washed are classified into cotton, blended fiber, synthetic fiber, silk, wool and artificial fiber.

Color: white and colorful colors shall be identified. All new colorful articles shall be washed in a separate way.

Operating Instructions

Checklist and preparation before washing clothes

Size: the articles of different sizes are washed together to increase the washing effects.

Sensitivity: soft articles shall be washed separately. As for new pure wool textiles, curtains and silks, the soft washing procedure shall be selected. Check the labels in all washing articles.

The clothes shall be sorted before being put into washing machine. As for the curtains with hooks, the hooks shall be removed before being washed.

The decorations on the clothes may damage the washing machine. As for the clothes with buttons or embroideries, they shall be turned over before being washed.

Clean up fasteners:

Zips shall be zipped close and buttons or hooks shall be fixed. The loose band or ribbon shall be bound together.



WARNING

It is suggested to put bras into the pillow slip with zip or buttons sealed to prevent the steel wire from popping out of bras into the drum and damaging the machine.

Especially delicate textiles such as laced curtains, straightjackets, small articles (tight socks, handkerchiefs, ties etc.) shall be put into string bag for washing.

When washing a single big and heavy dress such as Turkish towels, jeans, wadded jackets etc., it may easily cause great eccentricity and give alarm due to great unbalance. Therefore it is suggested to add one or two more clothes to be washed together so that draining can be done smoothly.

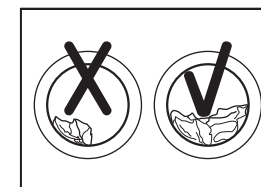
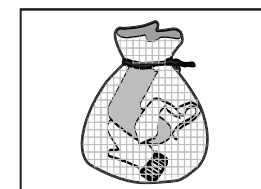

Clean away dusts, stains and pet hairs from the clothes.

The clothes may be damaged and disturb washing effects during the friction between dusts, stains and clothes.

To protect baby skin

Baby articles (baby clothes and towels) including napkins shall be washed separately.

If they are washed together with the adults' clothes, they may be infected. Rinsing times shall be increased to ensure the thorough rinsing and cleaning without the detergent residues.

It is suggested that the parts that are easily stained such as white sockets, collars and sleeves etc. shall be hand washed before being put into washing machine to achieve more ideal washing effects.

Please use powder or liquid detergents. The residues of the soap could remain in the gaps of the clothes if soap is used.

Operating Instructions

Checklist and preparation before washing clothes

The clothes which easily get fuzzed shall be turned over for washing

The clothes which easily get fuzzed shall be washed separately; otherwise the other articles can be stained with dust and thrum etc. Preferably, black clothes and cotton clothes shall be washed separately because they can easily get stained with the thrums of other colors when being washed together.

Please check before washing.

Washing machine shall not wash water-proof materials (ski suits, outside napkin pads, curtains).

As for the fiber products that water can not get soaked easily into such as water-proof cushions, and clothes, it is better not to wash. Otherwise there will be water bursting out or abnormal vibration to cause danger while rinsing and draining so that the clothes also may be damaged. (Such as outside napkin pads, raincoats, umbrella, ski suits, car covers, sleeping sacks etc.)

Cautions during Draining

Draining of normal clothes:

Moistures of washings are drained through drain hole.

Draining of water-proof clothes and fiber products:

In the normal washing and draining status, moistures of water-proof clothes and fiber products can not be drained while water is gathered in one direction so that the eccentricity of washing machine is too great and vibration or moving is caused.

Operating Instructions

View of control panel

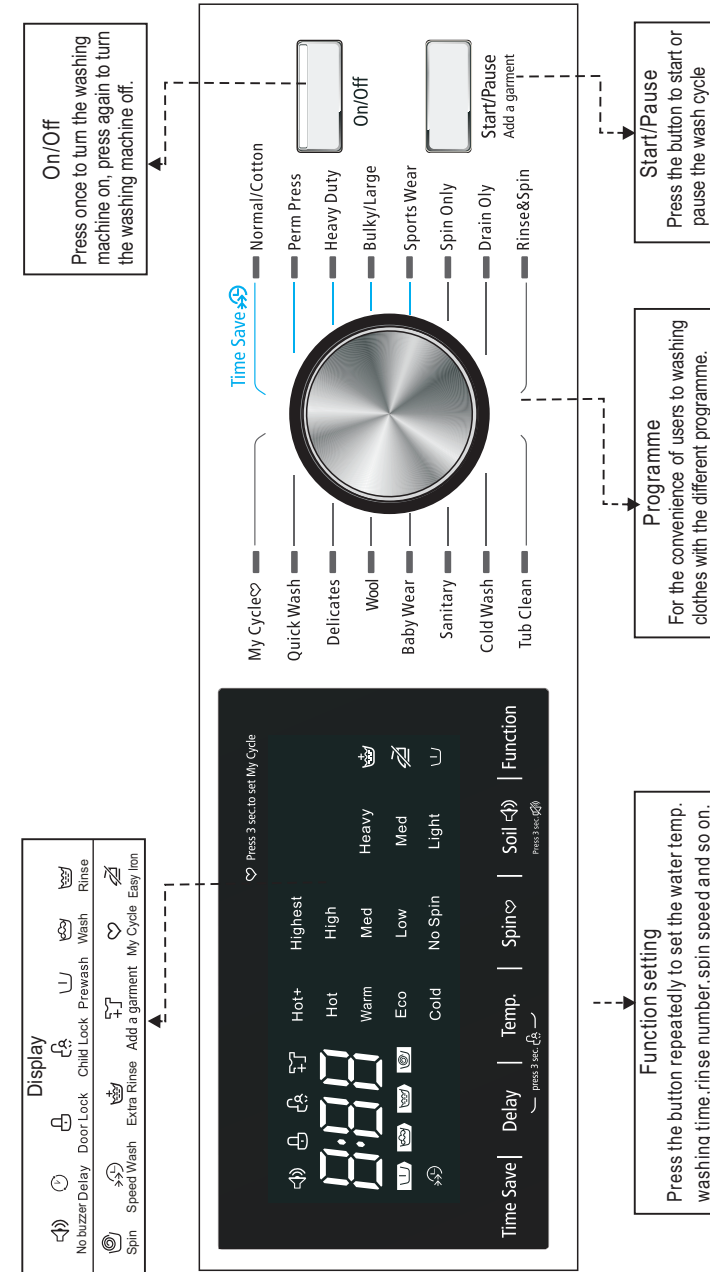

- Notes:**
1. The Control panel line chart is for reference only, Please refer to real product as standard.
 2. The Control panel could be changed without written notice. Please visit the website of Washing Machine or call up the service line for consultation.

Operating Instructions

View of control panel

View of the programme

- Normal/Cotton

Hard-wearing textiles, heat-resistant textiles made of cotton or linen.

- Heavy Duty

This program is intended for washing the heavy clothing like towels.

- Bulky/Large

This program is intended for washing the large clothing .

- Sports Wear

Washing the activewear.

- Spin Only

Extra spin with selectable spin speed.

- Rinse&Spin

Extra rinse with spin.

- Tub Clean

This program is specially set in this machine to clean the drum and tube. It applies high temperature sterilization to make the clothes washing more green. When this procedure is performed, the clothes or other washing cannot be added. When proper amount of chlorine bleaching agent is put in, the barrel cleaning effect will be better. The customer can use this procedure regularly according to the need.

- Quick Wash

Extra short programme approx, suitable for lightly soiled washing as a small amounts of laundry.

Operating Instructions

View of control panel

View of the programme

- Delicates

For delicate, washable textiles, e.g. made of silk, satin, synthetic fibres or blended fabrics.

- Sanitary

Give full play to its active enzyme washing powder, with 60 ° Lord washed and prewash function, suitable for difficult to wash the clothes.

- Wool

You can select this procedure to wash the wool textiles labeled with "Machine Wash".

Please select the proper washing temperature according to the label on the articles to be washed. Furthermore, the proper detergent shall be selected for wool textiles.

-Perm Press

Moderate strength of washing. This function can be used to reduce the wrinkles of clothes.

-Baby Wear

Washing the baby's clothes, it can make the baby's wear cleaner. and make the rinse performance better to protect the baby skin.

- Auto Dry

Select it to dry clothes. The drying time according to the load .

-My Cycle

Press Spin 3sec. for my cycle to memory the programme.

-Cold Wash

Cold water flows in during wash.

-Drain Only

Drain off the water.

Operating Instructions

View of control panel

-Timed Dry

Load(kg)	Dry programme (min)	Dry Capacity (kg)	The reference weight of dry clothes	moisture content
12kg	59	0.8	4 shirts or 1 jean, 1 synthetic	60%
	89	1	4 shirts, 1 T-shirt or 1jean, 1 synthetic, 1 T-shirt	60%
	200	3	3.0kg mix	60%

The Special function

- Time Save The function can decrease the washing time.

-Child Lock

To avoid that the washing procedure cannot operate normally due to the mis operation by kids during the washing procedure, you can select this function, In this case, the other buttons except On/Off button can not work, at this state ,the machine power off when press the key on/off.

Press Function and Select together 3 seconds during the running procedure, the buzzer will beep ,Start/Pause button as well as the rotary switch are locked. Press the two buttons for 3 seconds together and buzzer will beep to release to locking. But cut off the power supply , the kid's protection is also release to locking for dry models. For the washer without dry function, cut off the power supply , the kid's protection is also remembered.

The kid's protection will not be cancelled after all procedures are completed.

- Delay

Delay function can be set with this button, the delaying time is 0-24H.

Set the delay function:

- 1.Select a programme;
- 2.Press the Delay button to choose the time;
- 3.Press Start/Pause to commence the Delay operation.

Cancel the Delay function :

Press the Delay button until the display will be 0H . It should be pressed before starting the program. If the program already started, should press the On/Off button.

Notes: If there is any break in the power supply while the machine is operating, a special memory stores the selected programme and when the power is restarted ,press the Start/Pause button the left time is continues.

- Add a garment

This operation can be executed during the washing procedure. When the drum of the washer (dryer) machine is still rolling and there is large amount of water with high temperature in the drum. The state is unsafe and the door cannot be opened forcefully. To press "Start/Pause"for 3 sec. to reload, and start the clothes adding in the midway function .

Please follow the steps as below:

- 1.Wait until the drum stops rotation.
- 2.The door lock is unlocked.
- 3.Close the door when the clothes needs are loaded and repress the"Start/Pause"button.

Notes:Don't use the Reload function when the water surface over the edge of the inner tub and the temperature is higher.

Operating Instructions

-Extra Rinse The laundry will undergo extra rinse once after you select it.

-Dry Press the Dry button continuously to choose the dry level: Extra Dry /Normal Dry/Gentle Dry.

-Mute Press the [Soil]button for 3sec.,the buzzer is mute.

-Soil It is suitable for different level of soil (from light to heavy).

The default level is light , would increase washing time when choose extra soil level.

-Temp. Press the button to regulate the temperature.

-Spin Press the button to change the spinspeed.

-Pre wash The prewash function can get an extra wash before main wash, it is suitable for washing the dust rises to surface of the clothes; You need to put detergent into the Case(I) when select it.

-Easy Iron Select this function to reduce the wrinkles of clothes.

Washing clothes at first time

Before washing clothes at first time, the washing machine shall be operated in one round of the whole procedures without clothes in as follows:

- 1.Connect power source and water.
- 2.Put a little detergent into the box and close it.
- 3.Press the button "On/off".
- 4.Press the button "Start/Pause".

The drawer is separated as follows:

I: Pre-detergent or washing powder.

II: main detergent, softener, pre-dip, bleaching or decontaminating products.

☼: washing additive, such as fabric softener or tackifier.

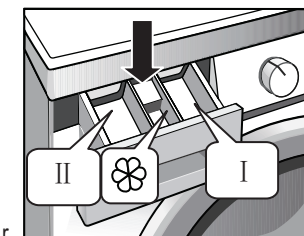

Put detergent into washing machine.

- 1.Pull out the drawer.
- 2.Fill pre-detergent into Case I (when necessary).
- 3.Fill detergent into Case II.
- 4.Fill softener into Case ☼ (when necessary).

Notes:

- As for the agglomerated or ropy detergent or additive, before they are poured into the detergent box, it is suggested to use some water for dilution to prevent the inlet of detergent box from being blocked and overflowing while filling water.
- Please choose suitable type of detergent for the various washing temperature to get the best washing effect with less water and energy consumption.

Start up washing machine

Connect the power. Check if water pipes are connected properly. Open the tap completely. Put in the clothes to be washed and fill in the detergent and tackifier. Then press the button "Power", Select the proper procedures and functions and press the button "Start/Pause".

Select the procedure

The proper washing procedures shall be selected according to the types, quantities, and dirtiness of the clothes to be washed in combination with the following washing temperature table.

Operating Instructions

Extra Hot (Hot+)	Seriously besmirched, pure white cotton or flax (for example: coffee table cloths, canteen table cloths, towels, bed sheets)
Hot	Moderately besmirched, colorful flax, cotton and synthetic articles with certain decolorizing degree (for example: shirts, night pajamas; Slightly besmirched, pure white flax (for example: underwear)
Warm	Normally besmirched articles (including synthetic and wool)

Operating Instructions

Table of washing procedures

Programme	Washing Load (kg)	Temp. (°C)	Default Time(H)	Spin Speed	Time Save	Extra Rinse	Easy Iron	Pre Wash	Delay
	12.0	Default							
Normal/Cotton	12.0	Warm	0:55	Med	○	○	○	○	○
Perm Press	6.0	Warm	0:57	Low	○	○	○	○	○
Heavy Duty	12.0	Hot	1:40	High	○	○	○	○	○
Bulky/Large	6.0	Eco	1:23	High	○	○	○	○	○
Sport Wear	6.0	Warm	0:57	Highest	○	○	○	○	○
Spin Only	12.0	–	0:13	High	–	–	○	–	○
Drain Only	12.0	–	0:01	–	–	–	–	–	○
Rinse&Spin	12.0	–	0:23	High	–	–	○	–	○
Tub Clean	–	Hot+	1:28	–	–	–	–	–	○
Cold Wash	12.0	Cold	1:09	High	–	○	○	○	○
Sanitary	6.0	Hot+	2:18	High	–	○	○	○	○
Baby Wear	12.0	Hot	1:37	High	–	○	○	○	○
Wool	2.0	Eco	1:01	Med	–	○	–	–	○
Delicates	2.5	Eco	0:58	Med	–	○	–	–	○
Quick Wash	2.0	Warm	0:36	Med	–	–	–	–	○

● Means must ○ Means optional

Energy test program: Normal/Cotton.

Note!

- The parameters in this table are only for user's reference. The actual parameters maybe different with the parameters in above mentioned table.

Care And Cleaning

Care and cleaning

Before your maintenance starts, please do pull out the power plug or disconnect power and close the tap.



WARNING

- Solvents are forbidden to avoid that the washing machine is damaged, and toxic gases are generated or exploded.
- Never use water to sprinkle and wash the washing machine.
- It is forbidden that the detergents containing PCMX are used to clean the washing machine.
- Certain internal parts are intentionally not grounded and may present a risk of electric shock only during servicing. Service Personnel-Do not contact the following parts while the appliance is energized: **Electrical valve, Drain Pump, Door Lock, Dry Heater(Combo), Fan Motor(Combo)**.

Cleaning and Maintenance of Washing Machine Cabinet

Proper maintenance on the washing machine can extend its working life. The surface can be cleaned with diluted non-abrasive neutral detergents when necessary. If there is any water overflow, use the wet cloth to wipe it off immediately. No sharp items are allowed to strike the cabinet.

Notes: formic acid and its diluted solvents or equivalent are forbidden.

Clean Internal Drum

The rusts left inside the drum by the metal articles shall be removed immediately with chlorine-free detergents.

Never use steel wool.

Dispose a Frozen Washing Machine

When the temperature drops below zero and your washing machine gets frozen, you may:

1. Disconnect the power supply for the washing machine.
2. Wash the tap with warm water to loosen inlet pipe.
3. Take down inlet pipe and immerse it in warm water.
4. Pour warm water into washing drum and wait for 10 minutes.
5. Reconnect inlet pipe to the tap and check whether inlet and outlet are working normally.

Notes: when the washing machine is reused, make sure the ambient temperature is above 0 C

Anti-freeze

If your washing machine is located in the room where it can get frozen easily, please drain the remaining water inside drain pipe and inlet pipe thoroughly.

Remove the remaining water in inlet pipe:

1. Close the tap.
2. Screw off the inlet pipe from tap and put its end into the container.
3. Start up any procedure except single Wash or Drain procedure. Water will be drained out of inlet pipe if any for about 40 seconds.
4. Reconnect the inlet pipe to tap.

Care And Cleaning

Care and cleaning

Remove the remaining water in drain pump



WARNING

To avoid burning, it shall be done after the hot water inside the machine cools down.

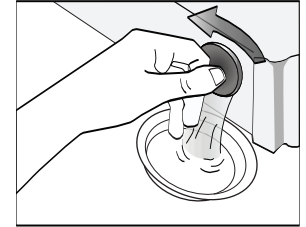

Clean detergent box and grooves

Clean detergent drawer and grooves

1. Press down the arrow location on softener cover inside the drawer.
2. Lift the clip up and take out softener cover and wash all grooves with water.
3. Restore the softener cover and push the drawer into position.

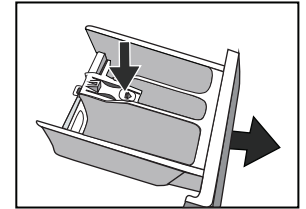

Clean inlet filter

Inlet filter shall must be cleaned if there is not any or insufficient water in when the tap is opened.

Clean the tap filter:

1. Close the tap.
2. Select any procedure except "Wash" or "Drain" procedure.
3. Press the button "Start/Pause" and keep the procedure running for about 40 seconds.
4. Remove the inlet pipe from the tap.
5. Use water to wash the filter.
6. Reconnect the inlet pipe.

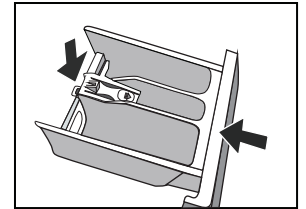
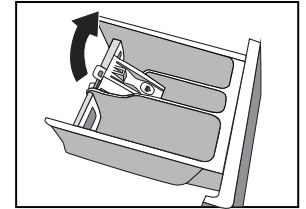

Washing the filter in washing machine:

1. Screw off the inlet pipe from the backside of the machine.
2. Pull out the filter with long nose pliers and reinstall it back after being washed.
3. Reconnect the inlet pipe.
4. Open the tap and make sure there is no water leakage.
5. Close the tap.

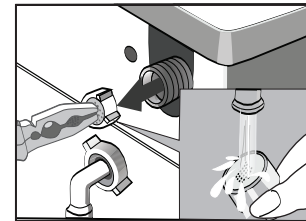

Care And Cleaning

Care and cleaning



Pull out the power plug to avoid electrical shock before washing.
After using the washing machine, pull out the power cord and close the door

WARNING tightly to avoid pinching the kids.

Remove foreign matters

Drain Pump Filter:

Drain pump filter can filter the yarns and small foreign matters from the washings.
Clean the filter periodically to ensure the normal operation of washing machine.



According to the soil level within the cycles and the frequency of the cycles, you have to inspect and clean the filter regularly.

WARNING The pump should be inspected if the machine does not empty and/or spin;
The machine makes an unusual noise during draining due to objects such as safety pins, coins etc. blocking the pump.

The Service_panel proceed as follows:

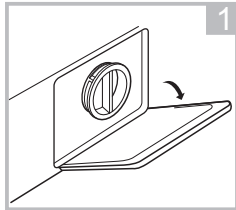

1. Open the lower cover cap

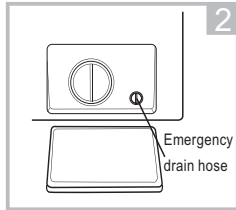

2. Rotate 90° and pull out the emergency drain hose, and take off the hose cap

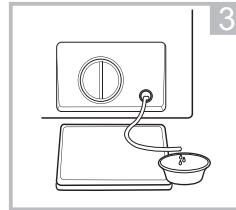

3. After water runs out, reset the drain hose

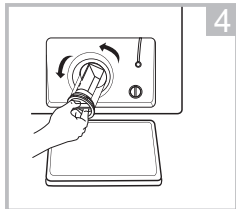

4. Open the filter by turning to the counter clockwise

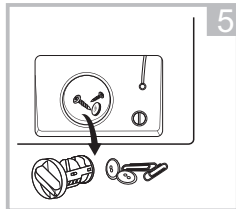

5. Remove extraneous matter

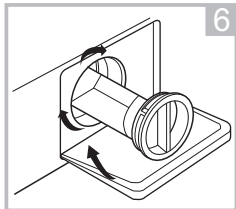

6. Close the lower cover cap

Warning!

When the appliance is in use and depending on the programme selected there can be hot water in the pump. Never remove the pump cover during a wash cycle, always wait until the appliance has finished the cycle, and is empty. When replacing the cover, ensure it is securely retight end so.

Care And Cleaning

Care and cleaning

Emergency Door Release

In case of power failure or other circumstances and door cannot be opened. If it is necessary to open the door under this circumstances, please pull down the pull cord inside emergency door and restore the pull cord after opening the door.

Emergency door pull cord

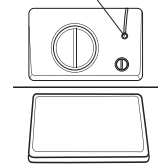

1. Open filter door

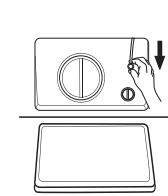

2. Emergency pull cord

Warning!

The machine is not allowed to use the emergency switch pull cord during washing. If need to run machine urgently, it is recommended to open door after water is cooled, to avoid getting burn caused by high temperature residual water outflow from the machine tub

Troubleshooting Tips

Troubleshooting tips

Troubles	Reason	Solution
Washing machine cannot start up		Check if the door is closed tightly. Check if power plug is inserted well. Check if water supply tap is opened. Check if button "On/Off" is pressed. Check if button "Start/Pause" is pressed.
Door cannot be opened	Machine's safety protection design is working.	Disconnect the power.
Heating fault	NTC is damaged and heating pipe is aging.	Can normally wash the clothes. Only cannot wash with heating. Shall contact the service center promptly.
Water leakage	The connection between inlet pipe or outlet hose and tap or washing machine is not tight. Drain pipe in the room is blocked.	Check and fasten water pipes. Clean up outlet hose and ask a specialized person to repair it when necessary.
Water is overflowed from the bottom of the machine	The inlet pipe is not connected firmly. Outlet hose has water leakage.	Fix the inlet pipe. Replace the drain hose.
Indicator or display does not light.	Power is disconnected. PC board has problems. Harness has connection problem.	Check if the power is shut down and power plug is connected correctly. If not, please call up service line.
Detergent residues in the box	Washing powder is dampened and agglomerated.	Clean and wipe the box. Use liquid detergents or the detergents special for drum.
Washing effects are not good	The clothes are too dirty. Insufficient detergent quantity.	Select a proper procedure. Add the proper detergent quantity according to the instructions in detergent package.
Abnormal noise Great vibration		Check if the fixing (bolts) has been removed. If cabinet is installed on the solid and level floor. Check if there are any barrettes or metal articles inside. Check if the legs in the washing machine are adjusted level.

Remove The Problems

Remove the problems

The start of the appliance does not work or it stops during operation.
First try to find a solution to the problem, If not, contact the service centre.

Description	Reason	Solution
Washing machine cannot start up	Door is not closed properly	Restart after the door is closed Check if the clothes is stuck
Door can't be opened	Washer's safety protection design is working	Disconnect the power, restart the product
Water leakage	The connection between inlet pipe or outlet hose is not tight	Check and fasten water pipes Clean up outlet hose
Detergent residues in the box	Detergent is dampened or agglomerated	Clean and wipe the detergent box
Indicator or display does not light	Disconnect the power PC board or harness has connection problem	Check if the power is shut down and the power plug is connected correctly
Abnormal noise		Check if the fixing (bolts) have been removed Check it's installed on a solid and level floor

Description	Reason	Solution
E30	Door is not closed properly	Restart after the door is closed Check if the clothes is stuck
E10	Water injecting problem while washing	Check if the water pressure is too low Straighten the water pipe Check if the inlet valve filter is blocked
E21	Overtime water draining	Check if the drain hose is blocked
E12	Water overflow	Restart the washer
EXX	Others	Please try again first, call up service line if there are still troubles

Note!

- After the check, activate the appliance. If the problem occurs or the display shows other alarm codes again, contact the service.

Appendix

Appendix

Care Label

Graphic Symbol	Illustration	Graphic Symbol	Illustration
	Hand Wash		No Machine Wash
	Washing (including Machine Wash and Hand Wash)		Do not Wash
	Dry Clean		No Dry Clean
	Warmly Dry Clean		No Wring
	Bleach		No Bleach
	Tumble dry		Do not Tumble Dry
	Iron		Do not Iron
	Steam Iron		Iron with Cloth
	Medium Temperature and Max. Temperature 150°C		Dry after Wash
	Line Dry		Line Dry in Shade

To avoid fire, electrical shock and other accidents, please remember the following reminding:

- Only the voltage indicated in power label can be used. If you are not clear of the voltage at home, please contact the local power bureau.
- When you are using the heating function, the maximum current through the washin machine will reach 12A. Therefore, please make sure the power supply units (current, voltage and cable) can meet the normal load requirements for the machine.
- Protect the power cord properly. Power cord shall be fixed well so that it will not trip the people or other things and be damaged. Special attention shall be paid to the socket. It shall be plugged into the sockets easily and attention shall be paid to the plug location.
- Do not make the wall-mounted socket overloaded or cable extended. Overloading of the wiring may cause fire or electrical shock. Do not pull out power plug with wet hand.
- To ensure your safety, power plug shall be inserted into an earthed three-pole socket. Carefully check and ensure that your socket is properly and reliably earthed.

Technical Specifications

Technical specifications

Parameter	
Power Supply	120V , 60Hz
Dimension(W*D*H)	595*640*850
Net Weight	73kg (161lb)
Washing Capacity	12.0kg (26lb)
Rated Current	11A
Standard Water Pressure	0.05MPa~1MPa



WARNING

Limited Warranty

Within the 48 contiguous United States, for one year from the date of purchase, when this appliance is operated and maintained according to instructions attached to or furnished with the product, warrantor will pay for factory-specified parts and repair labor to correct defects in materials or workmanship. Service must be provided by a designated service company. Outside the 48 states, all parts are warranted for one year from manufacturing defects. Plastic parts, shelves and cabinets are warranted to be manufactured to commercially acceptable standards, and are not covered from damage during handling or breakage.

ITEMS WARRANTOR WILL NOT PAY FOR:

1. Service calls to correct the installation of your appliance, to instruct you how to use your appliance, to replace or repair fuses or to correct wiring or plumbing.
2. Service calls to repair or replace appliance light bulbs or broken glass shelves. Consumable parts (such as filters) are excluded from warranty coverage.
3. Damage resulting from accident, alteration, misuse, abuse, fire, flood, acts of God, improper installation, installation not in accordance with electrical or plumbing codes, or use of products not approved by warrantor.
4. Replacement parts or repair labor costs for units operated outside the United States.
5. Repairs to parts or systems resulting from unauthorized modifications made to the appliance.
6. The removal and reinstallation of your appliance if it is installed in an inaccessible location or is not installed in accordance with published installation instructions.

DISCLAIMER OF IMPLIED WARRANTIES – LIMITATION OF REMEDIES

CUSTOMER'S SOLE AND EXCLUSIVE REMEDY UNDER THIS LIMITED WARRANTY SHALL BE PRODUCT REPAIR AS PROVIDED HEREIN. IMPLIED WARRANTIES, INCLUDING WARRANTIES OF MERCHANTABILITY OR FITNESS FOR A PARTICULAR PURPOSE, ARE LIMITED TO ONE YEAR. WARRANTOR SHALL NOT BE LIABLE FOR INCIDENTAL OR CONSEQUENTIAL DAMAGES. SOME STATES DO NOT ALLOW THE EXCLUSION OR LIMITATION OF INCIDENTAL OR CONSEQUENTIAL DAMAGES, OR LIMITATIONS ON THE DURATION OF IMPLIED WARRANTIES OF MERCHANTABILITY OR FITNESS, SO THESE EXCLUSIONS OR LIMITATIONS MAY NOT APPLY TO YOU. THIS WARRANTY GIVES YOU SPECIFIC LEGAL RIGHTS AND YOU MAY ALSO HAVE OTHER RIGHTS, WHICH VARY FROM STATE TO STATE.



WARNING: This product can expose you to chemicals including Nickel (Metallic) which is known to the State of California to cause cancer, birth defects or other reproductive harm.

For more information go to www.P65Warnings.ca.gov

Note: Nickel is a component in all stainless steel and some other metallic compositions.



AVERTISSEMENT : Ce produit peut vous exposer à des produits chimiques, y compris le nickel (métallisé), qui est connu de l'État de Californie pour causer le cancer, des anomalies congénitales ou d'autres problèmes de reproduction.

Pour plus d'informations, visitez le site www.P65Warnings.ca.gov

Remarque : Le nickel est un composant de tout acier inoxydable et d'autres compositions métalliques.

FELIX STORCH, INC.
770 Garrison Avenue
Bronx, New York 10474
Phone: (718) 893-3900
Fax: (844) 478-8799
www.summitappliance.com

SUMMIT

For parts and accessory ordering,
troubleshooting and helpful hints,
visit:www.summitappliance.com/support