

# Operating and installation instructions

GB

Combined fridge-freezer with BioFresh compartment for integrated use, door-on-door

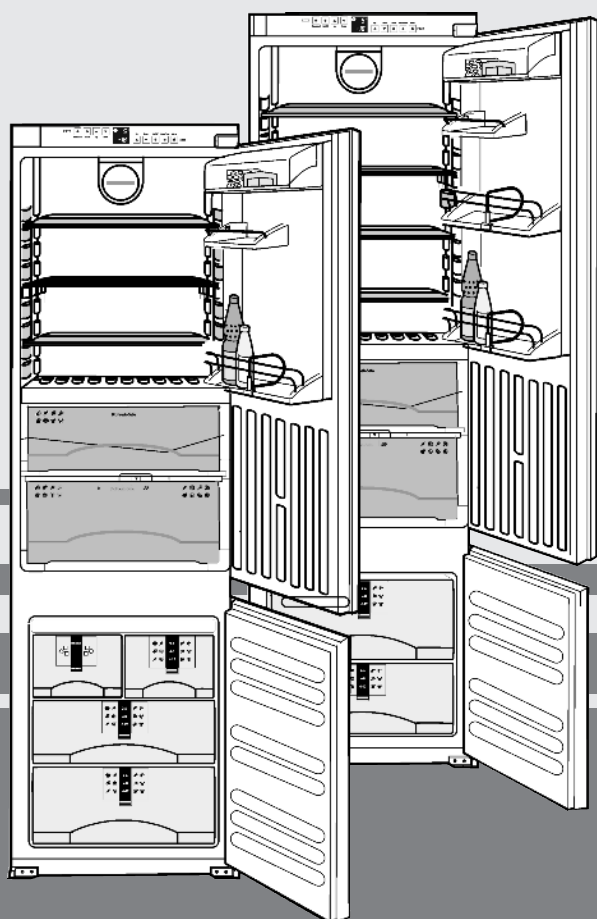

04/08 **7082530 - 02**

ICB/ICBN ... 6

# LIEBHERR

# Appliance at a glance

## Contents

<b>1</b>	<b>Appliance at a glance</b> .....	<b>2</b>
1.1	Range of appliance use.....	2
1.2	Conformity.....	2
1.3	Appliance and equipment overview.....	2
1.4	Net@Home.....	3
<b>2</b>	<b>General safety information</b> .....	<b>3</b>
<b>3</b>	<b>Controls and displays</b> .....	<b>3</b>
3.1	Operating and control elements.....	3
3.2	Temperature display.....	3
<b>4</b>	<b>Putting into operation</b> .....	<b>4</b>
4.1	Changing the door hinges.....	4
4.2	Installation.....	4
4.3	Transporting the appliance.....	8
4.4	Installing the appliance.....	8
4.5	Disposing of packaging.....	8
4.6	Connecting the appliance.....	8
4.7	Switching on the appliance.....	9
<b>5</b>	<b>Control</b> .....	<b>9</b>
5.1	Saving energy.....	9
5.2	Brightness of the temperature display.....	9
5.3	Child proofing.....	9
5.4	Door alarm.....	9
5.5	Temperature alarm.....	9
5.6	Refrigerator compartment.....	10
5.7	BioFresh compartment.....	11
5.8	Freezer compartment.....	12
<b>6</b>	<b>Maintenance</b> .....	<b>14</b>
6.1	Manual defrosting.....	14
6.2	Defrosting with NoFrost.....	14
6.3	Cleaning the appliance.....	14
6.4	Customer service.....	15
<b>7</b>	<b>Malfunction</b> .....	<b>15</b>
<b>8</b>	<b>Decommissioning</b> .....	<b>16</b>
8.1	Switching off the appliance.....	16
8.2	Taking out of service.....	16
<b>9</b>	<b>Disposing of the appliance</b> .....	<b>16</b>

The manufacturer works constantly on the further development of all the types and models. Therefore please understand that we have to reserve the right to make design, equipment and technical modifications.

To get to know all the benefits of your new appliance, please read the information contained in these instructions carefully.

The instructions apply to several models. Differences may occur. Text relating only to specific appliances is marked with an asterisk (\*).

Instructions for action are marked with a ►, the results of action are marked with a ▷.

## 1 Appliance at a glance

### 1.1 Range of appliance use

The appliance is designed for refrigerating food, for freezing and storing food and for making ice.

The appliance was designed for household use. It is not intended for commercial use, in particular it is not meant for laboratory purposes and the like. There is the danger of malfunction.

The appliance is set to operate within specific ambient temperature limits according to its climate rating. The correct climate rating for your appliance is indicated on the type plate.

### Note

► Compliance with the specified ambient temperatures is required, otherwise the refrigeration performance is reduced.

Climate rating	for ambient temperatures of
SN	10 °C to 32 °C
N	16 °C to 32 °C
ST	16 °C to 38 °C
T	16 °C to 43 °C

### 1.2 Conformity

The refrigerant circuit has been tested for leaks. When installed, this appliance complies with the relevant safety provisions and EC directives 2006/95/EC and 2004/108/EC.

### 1.3 Appliance and equipment overview

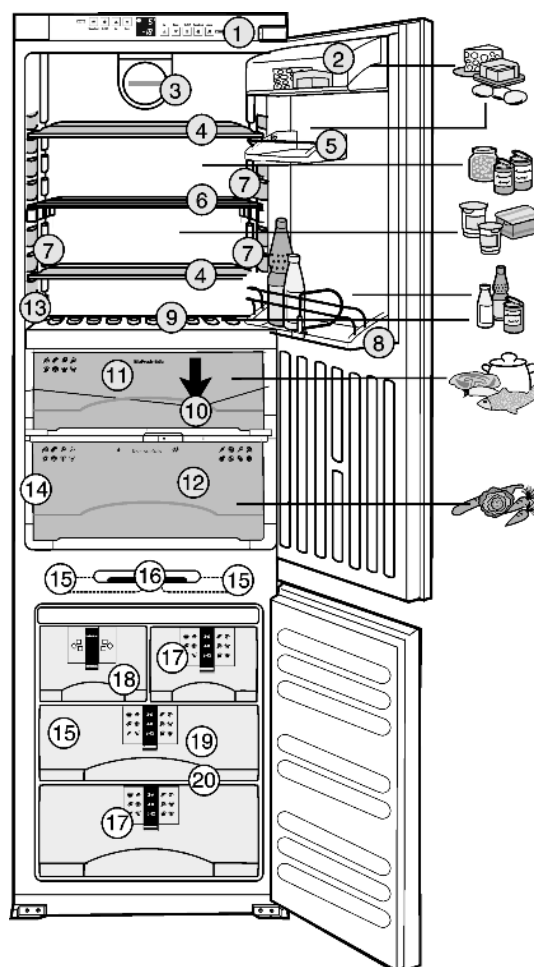

Fig. 1

- |   |  |
|---|--|
| (1) Operating and control elements            | (11) DrySafe                               |
| (2) Butter and cheese compartment             | (12) HydroSafe                             |
| (3) Fan                                       | (13) Type plate                            |
| (4) Shelf, relocatable                        | (14) Interior light, Biofresh compartment* |
| (5) Egg tray*                                 | (15) Cold storage accumulator*             |
| (6) Shelf, sectioned*                         | (16) Interior light, freezer compartment*  |
| (7) Interior light, refrigerator compartment* | (17) Information system*                   |
| (8) Storage rack for tall bottles             | (18) IceMaker*                             |

- (9) Integrated bottle shelf or glass shelf
- (10) Drain opening
- (19) Freezer tray\*
- (20) VarioSpace\*

## 1.4 Net@Home

The appliance can be fitted with the retrofit modules for the HomeDialog system or the serial interface (RS 232), depending on model and options. The modules are available from your specialist dealer.

You will find more information on the internet at [www.liebherr.com](http://www.liebherr.com).



## 2 General safety information

### Danger for the user:

- This appliance is not intended for use by persons (including children) with reduced physical, sensory or mental capabilities or lack of experience and knowledge, unless they are instructed in the use of the appliance and are initially supervised by a person responsible for their safety. Keep children under supervision to ensure they do not play with the appliance.
- In case of a fault, pull out the mains plug (not by pulling the connecting cable) or switch off the fuse.
- Have any repairs to or intervention in the appliance, and any change of the mains power cable, carried out by the customer service only or by other specialised personnel trained for the purpose.
- When disconnecting the appliance from the supply, always take hold of the plug. Do not pull the cable.
- Install and connect the appliance only as instructed.
- Keep these instructions in a safe place and hand them on to any subsequent owner.

### Fire hazard:

- The refrigerant R 600a is environmentally friendly but flammable. Escaping refrigerant may ignite.
  - Do not damage the refrigerant circuit pipes.
  - Do not allow naked flames or ignition sources to enter the appliance.
  - Do not use any electrical appliances in the interior (e.g. steam cleaners, heaters, ice cream maker etc.).
  - If refrigerant escapes: clear the vicinity of the leakage from any naked flames or ignition sources. Pull out the plug. Ventilate the area well. Notify customer service.
- Do not store explosives or sprays using combustible propellants such as butane, propane, pentane, etc. in the appliance. Respective spray cans can be identified by reference to the contents printed on the can or by a flame symbol. Gases possibly escaping may ignite due to electrical components.
- Only store high-percentage alcohol in tightly sealed, upright containers. Alcohol possibly escaping may ignite due to electrical components.

### Danger of tipping and falling:

- Do not misuse the plinth, drawers, doors etc. as a step or for support. This applies particularly to children.

### Danger of food poisoning:

- Do not consume food which has been stored too long.

### Danger of frostbite, numbness and pain:

- Avoid lasting skin contact with cold surfaces or refrigerated/frozen food or take protective steps, e.g. wear gloves. Do not consume ice cream, water ice or ice cubes immediately and do not consume them too cold.

Please observe the specific information in the other sections:

	DANGER	identifies a situation involving direct danger which, if not obviated, may result in death or severe bodily injury.
	WARNING	identifies a dangerous situation which, if not obviated, may result in death or severe bodily injury.
	CAUTION	identifies a dangerous situation which, if not obviated, may result in minor or medium bodily injury.
	NOTICE	identifies a dangerous situation which, if not obviated, may result in damage to property.
	Note	identifies useful information and tips.

## 3 Controls and displays

### 3.1 Operating and control elements

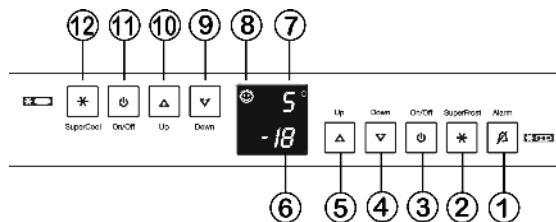

Fig. 2

- (1) Alarm button
- (2) SuperFrost button
- (3) On/Off button freezer compartment
- (4) Down setting button freezer compartment
- (5) Up setting button freezer compartment
- (6) Temperature display freezer compartment
- (7) Temperature display refrigerator compartment
- (8) Child lock symbol
- (9) Down setting button refrigerator compartment
- (10) Up setting button refrigerator compartment
- (11) On/Off button refrigerator compartment
- (12) SuperCool button

### 3.2 Temperature display

The following are displayed in normal operation:

- the highest freezer temperature
  - the average refrigerator compartment temperature
- The freezer compartment temperature display flashes:
- the temperature setting is changed
  - after switch-on the temperature is not yet cold enough
  - the temperature has risen several degrees

Dashes flash in the display:

- the freezer temperature is above 0 °C.

The following displays indicate malfunction. You will find possible causes and corrective action in the section on malfunction.

- nR
- F0 to F5

# Putting into operation

## 4 Putting into operation

### 4.1 Changing the door hinges

#### ATTENTION\*

Risk of damage to side-by-side appliances by condensate!  
A side-by-side (SBS) appliance may be installed only with the door hinges as delivered.

- ▶ Do not change over the door hinges.

Make sure the following tools are to hand:

- spanner 13
- cordless screwdriver Torx 15, 20, 25, 30

Slide the appliance 2/3 of the way into the recess.

Pull out the mains plug.

Open the doors.

#### 4.1.1 To detach the soft stop mechanism



#### CAUTION

Risk of injury if soft stop contracts!

- ▶ Detach with care.

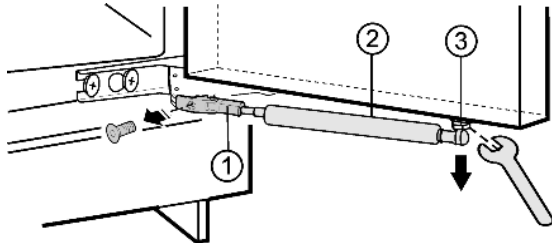

Fig. 3

- ▶ Unscrew holder Fig. 3 (1).
- ▶ Unscrew the ball stud Fig. 3 (3) together with the soft stop mechanism Fig. 3 (2) from the door and set it aside.

#### 4.1.2 To change the hinges

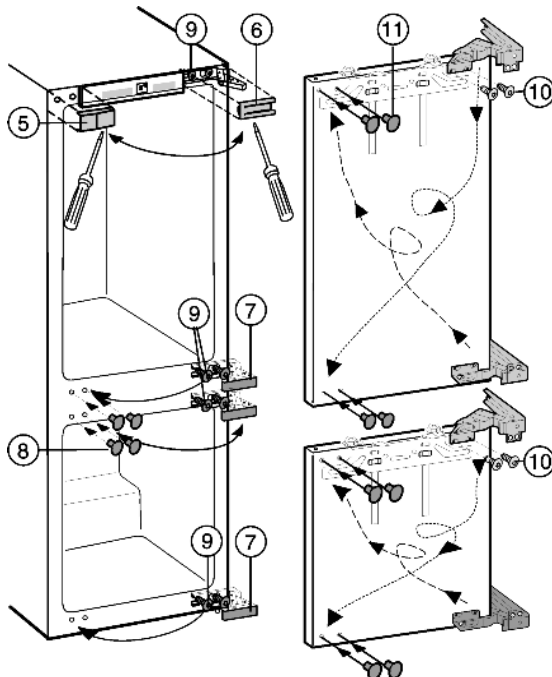

Fig. 4

- ▶ Lift off the covers Fig. 4 (5,6,7,8) forwards using a flat-blade screwdriver.
- ▶ Loosen the top and bottom screws Fig. 4 (9) on the appliance body, without removing them.
- ▶ Pull the doors outwards and detach them.

- ▶ Transfer the screws Fig. 4 (9) to the opposite side and screw them in a little.
- ▶ Undo the screws Fig. 4 (10) and change over the hinges diagonally.

The screws Fig. 4 (10) are self-tapping: use a cordless screwdriver.

- ▶ Screw the hinges tight.
- ▶ Place plugs Fig. 4 (11) in the now unused fastening holes.
- ▶ Attach the doors to the prefitted screws Fig. 4 (9) and tighten the screws.

#### 4.1.3 Re-fit the soft stop mechanism

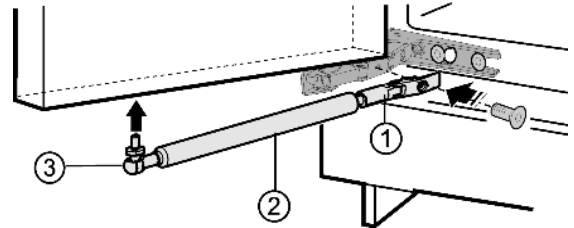

Fig. 5

- ▶ Screw on the holder Fig. 5 (1).
- ▶ Screw the ball stud Fig. 5 (3) together with the soft stop mechanism Fig. 5 (2) into the fastening hole.
- ▶ Re-fit all the covers Fig. 4 (5,6,7,8).

## 4.2 Installation

All the fasteners accompany the appliance.

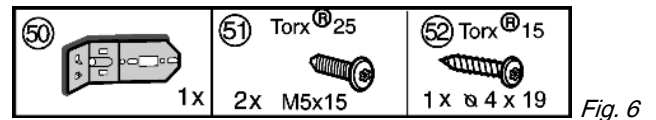

Fig. 6

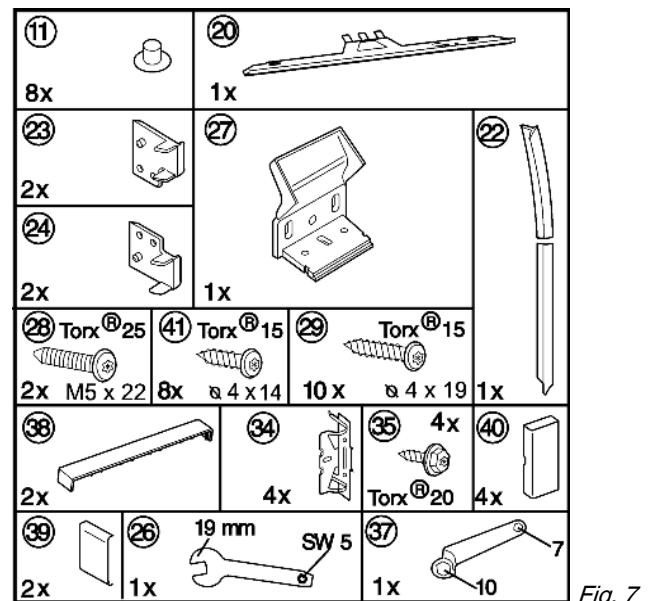

Fig. 7

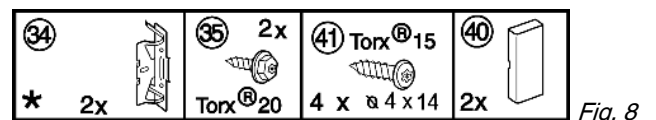

Fig. 8

Ensure that the following tools are to hand:

- cordless screwdriver Torx@15, 20, 25
- spanner 13

The shelf and side walls of the unit must be at right-angles to one another. Align the unit with a spirit level and an angle. If necessary, level out by building up from underneath.

The appliance can also be installed in an ordinary kitchen cabinet. In this case detach the fittings of the unit door and recess. They are no longer needed as the unit door is fitted to the appliance door.

## Note

- ▶ Before assembling the door of the unit, make sure that the admissible weight of the unit door is not exceeded.
- ▶ Otherwise damage to the hinges and resultant malfunction cannot be ruled out.

	Max. weight of unit door
Refrigerator compartment door	20 kg
Freezer compartment door	12 kg

Check installation dimensions:

	A	B	C
ICB 31	1772 mm - 1788 mm	1770 mm	549 mm
ICBN 30	1772 mm - 1788 mm	1770 mm	695 mm

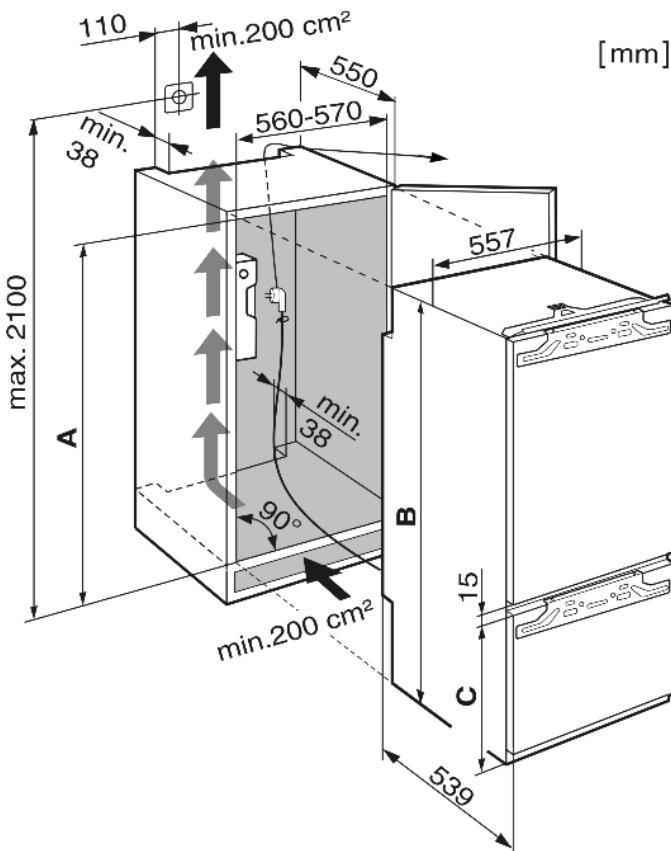

Fig. 9

## 4.2.1 Assembling appliance

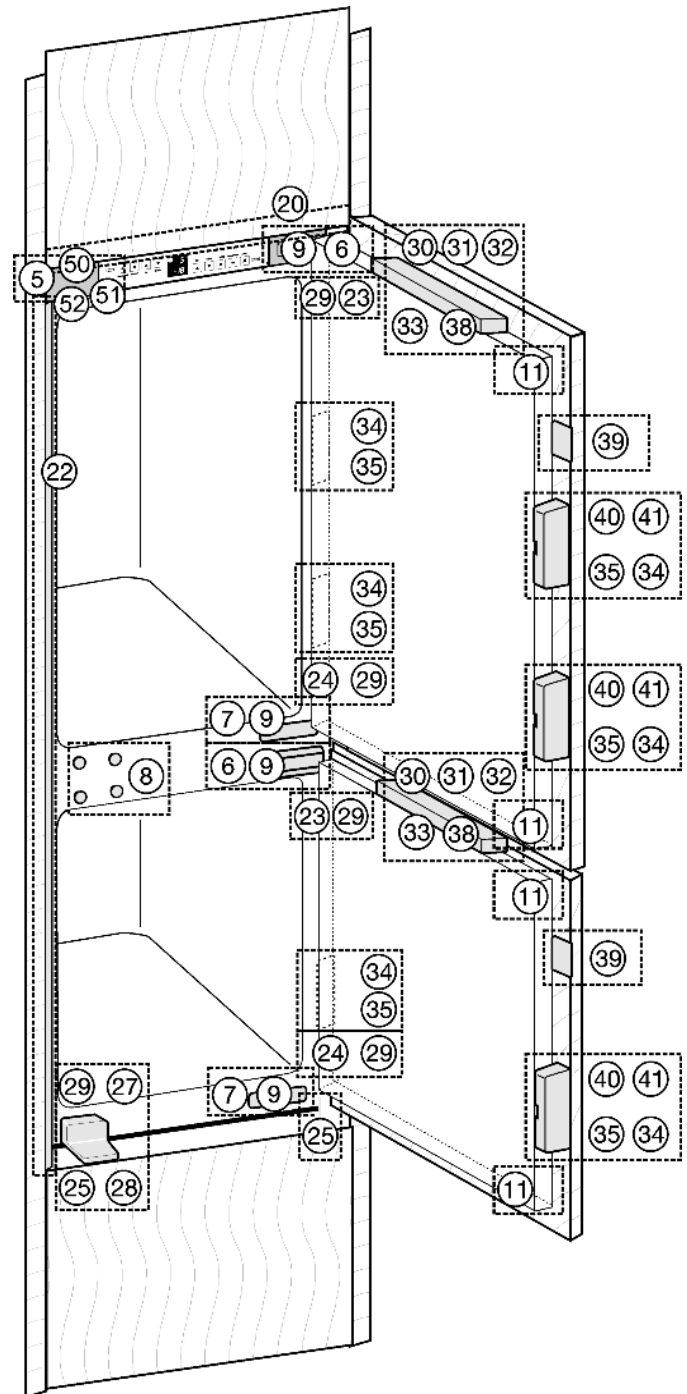

Fig. 10

- ▶ Detach the connecting cable from the back of the appliance, removing the cable holder because otherwise there will be vibratory noise!
- ▶ Lay the connecting cable with the help of a string in such a way that the appliance can be easily connected after fitting.
- ▶ Slide the appliance 2/3 of the way into the recess.
- ▶ Remove covers Fig. 10 (5,6,7).
- ▶ Fit the equaliser trim Fig. 12 (20) centrally onto the appliance: slide into holding fixture and engage in keyholes.

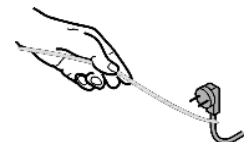

Fig. 11

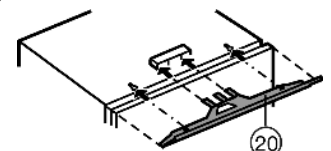

Fig. 12

# Putting into operation

- ▶ Screw mounting bracket Fig. 13 (34) with hexagon screw Fig. 13 (35) into the pilot holes in the appliance door.

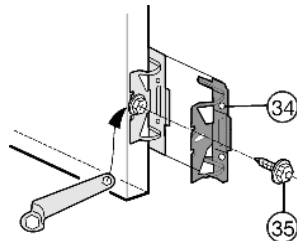

Fig. 13

**For 16 mm thick unit walls = 568 mm wide recess:**

- ▶ Clip spacer Fig. 14 (23) onto the upper hinge and spacer Fig. 10 (24) onto the lower hinge.

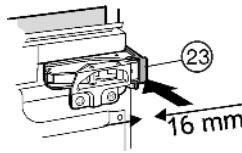

Fig. 14

- ▶ Screw plastic bracket Fig. 15 (27) onto the handle side of the appliance with M5 screws Fig. 15 (28).

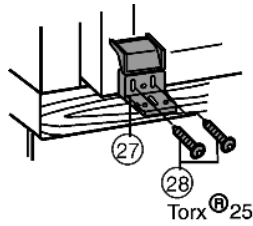

Fig. 15

- ▶ Loosely screw Fig. 16 (51) the mounting bracket Fig. 16 (50) to the appliance through the oblong holes.
- ▶ The bracket can then still be aligned to the wall of the unit.

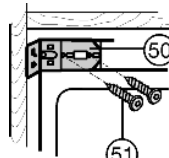

Fig. 16

- ▶ Remove the protective film from the trim Fig. 17 (22). Apply the strip to the bottom edge of the mounting bracket Fig. 16 (50) on the side wall of the appliance on the handle side and flush with the front and glue on.
- ▶ If necessary, shorten the trim Fig. 17 (22) to the height of the recess.\*

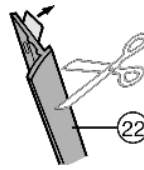

Fig. 17

## To slide in and align the appliance:

- ▶ Slide in the appliance.

**For 16 mm thick unit walls = 568 mm wide recess:**

- ▶ Slide appliance into the recess until the spacers make contact with the side wall of the unit.

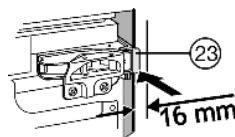

Fig. 18

**For 19 mm thick unit walls = 562 mm wide recess:**

- ▶ Align the front edges of the hinges so as to be flush with the side wall of the unit.

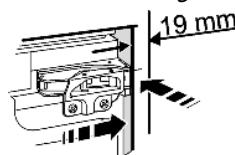

Fig. 19

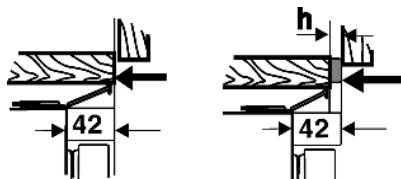

Fig. 20

**In case of units with (16 mm and 19 mm) door stop components (knobs, sealing lips etc.):**

- ▶ To allow for the extra distance (depth of door stop components): allow the hinges to protrude by the extra distance.

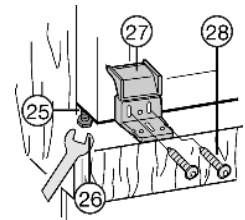

Fig. 21

## For units without door stop components:

- ▶ Align the plastic bracket Fig. 21 (27) in depth so as to be flush with the front edge of the base of the unit.

## For units with door stop components:

- ▶ allow for additional space needed: align plastic bracket Fig. 21 (27) parallel to the front edge of the hinge.

## For units with set back base:

- ▶ Align plastic bracket Fig. 21 (27) in depth so as to be flush with the front edges of the side walls of the unit, even if the bracket projects over the base of the unit as a result.
- ▶ Level the appliance by means of the adjustable feet Fig. 21 (25) using the accompanying spanner Fig. 21 (26).

## Note

Incorrect installation will lead to malfunction!

If the distance is not kept, the door may not close. This may lead to icing, to condensate forming and to malfunction.

- ▶ Be sure to keep to a spacing of 42 mm all the way round. (Allow for door stop components, such as knobs and sealing lips.)

## To secure the appliance in the recess:

- ▶ On both doors fit Spax screws Fig. 22 (29) through the plates of the upper and lower hinges.

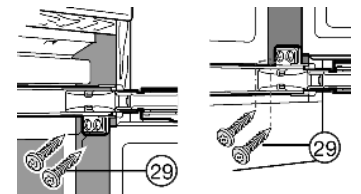

Fig. 22

- ▶ Screw the mounting bracket tight onto the unit wall with Spax screw  $\varnothing 4 \times 19$  Fig. 23 (52).

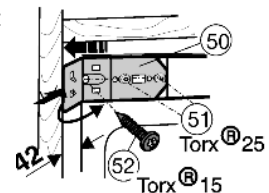

Fig. 23

- ▶ Push the mounting bracket Fig. 23 (50) against the wall of the unit and tighten the two M5 screws, Torx 25 Fig. 23 (51).

- ▶ Preassemble by passing a long screw Fig. 24 (29) through the oblong hole in the plastic bracket Fig. 24 (27).

- ▶ Fold down the cover of the plastic bracket Fig. 24 (27).

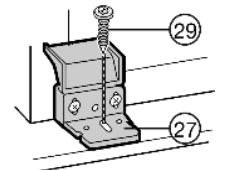

Fig. 24

- ▶ Close the appliance door.

## 4.2.2 Fitting the unit doors

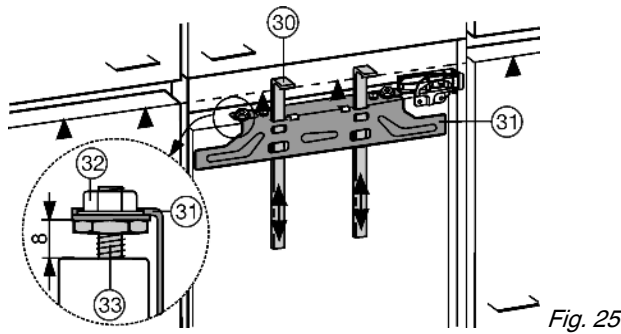

Fig. 25

The fitting aids Fig. 25 (30) are required for both doors. Therefore fit the doors of the units one after the other.

- ▶ Check 8 mm presetting. (Distance between appliance door and lower edge of crosspiece)
- ▶ Raise fitting aids Fig. 25 (30) to unit door height. Lower edge  $\Delta$  of fitting aid = upper edge of unit door to be fitted.
- ▶ Unscrew crosspiece Fig. 26 (31) by undoing the locknuts Fig. 25 (32).
- ▶ Attach the crosspiece Fig. 26 (31) to the inside of the unit door using the fitting aids Fig. 26 (30).

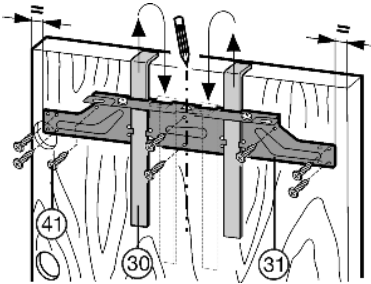

Fig. 26

- ▶ Centre the crosspiece Fig. 26 (31): mark a short centre line on the unit door and put the tip of the arrow on the crosspiece above it.
- ▷ Distances to the outer edge are equal at the left and right.
- For chipboard doors:**
- ▶ fix the crosspiece Fig. 26 (31) with at least 6 screws Fig. 26 (41).
- For frame and panel doors:**
- ▶ fix the crosspiece Fig. 26 (31) with 4 screws Fig. 26 (41) at the edge.
- ▶ Lift out the fitting aids Fig. 26 (30), turn round and insert into the adjacent openings.

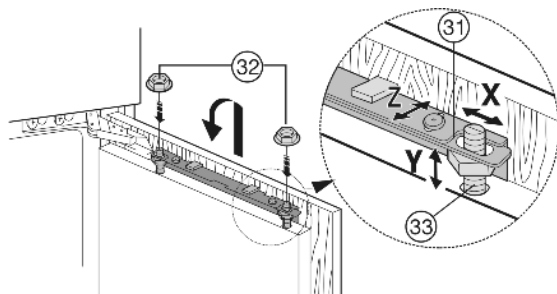

Fig. 27

- ▶ Attach the unit door to the adjusting bolts Fig. 27 (33) and loosely screw the locknuts Fig. 27 (32) onto them.
- ▶ Close the door.
- ▶ Check the gap between the door and the surrounding unit doors.
- ▶ To laterally align the unit door: move the unit door in the X direction.
- ▶ To align the unit door in height and lateral inclination: set the adjusting bolts Fig. 27 (33) with a screwdriver.
- ▷ The unit door is flush and in alignment with the surrounding unit fronts.
- ▶ Tighten counter nuts Fig. 27 (32).

Mounting bracket: Fig. 28 (34) Ensure that both metal edges are flush (symbol //):

- ▶ Drill pilot holes in the door of the unit (possibly make preliminary hole with a bradawl).

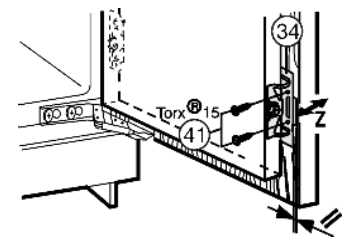

Fig. 28

- ▶ Screw the appliance door to the unit door with screws Fig. 28 (41) passed through the mounting brackets Fig. 28 (34).

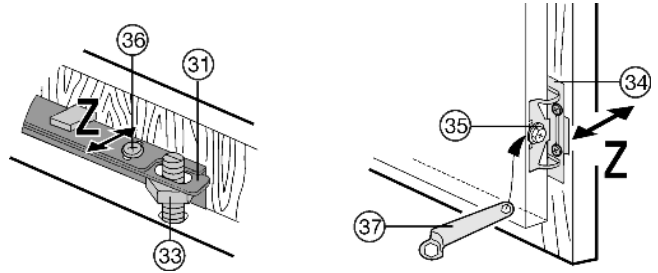
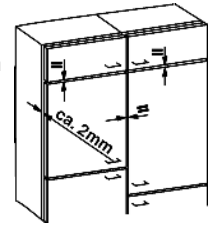

Fig. 29

- ▶ To align the unit door in depth Z: undo top screws Fig. 29 (36), bottom hexagon screws Fig. 29 (35) with accompanying ring spanner Fig. 29 (37), then move the door.
- ▶ Do not allow knobs and sealing lips to contact the door - important for function!
- ▶ Allow an air gap of approx. 2 mm between the unit door and the body of the unit.



**For large unit doors:**

- ▶ fit a 3rd pair of mounting brackets Fig. 29 (34).
- ▶ Use the holes pre-drilled in the handle area of the appliance door for this purpose.

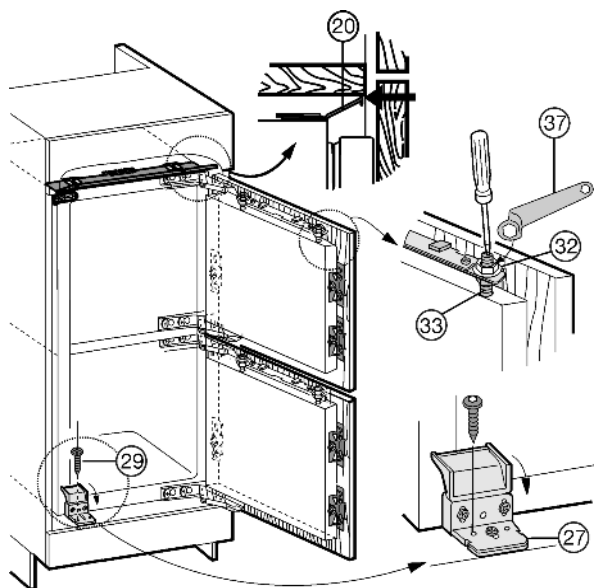
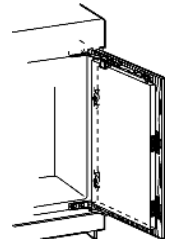
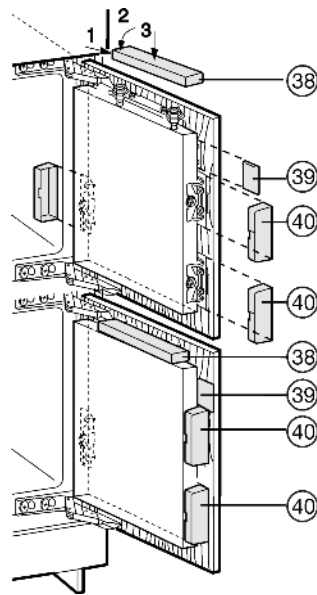

Fig. 30

- ▶ Check the fit of the door and readjust if necessary.
- ▶ Tighten all screws.

## Putting into operation

- ▶ Tighten the counternuts *Fig. 30 (32)* with the ring spanner *Fig. 30 (37)* provided, counter-holding the adjusting bolts *Fig. 30 (33)* with a screwdriver.
- ▶ Align the equaliser trim *Fig. 30 (20)* if necessary by moving it parallel to the base of the unit, so that it does not project.
- ▶ Fix the appliance in the round hole at the bottom with the second screw *Fig. 30 (29)* through the plastic bracket *Fig. 30 (27)*.
- ▶ Position upper covers *Fig. 31 (38)* and snap into place.
- ▶ Place lateral covers *Fig. 31 (39)* in position, slide them to the limit, then press, until you hear them snap into place.
- ▶ Attach covers *Fig. 31 (40)* to the side and then draw them forwards with a screwdriver so that they snap into place.



*Fig. 31*

- ▶ Attach covers *Fig. 10 (5,6,7)*.
- Check the following points to ensure the appliance is fitted properly. Failure to do so may lead to icing, condensate forming and malfunction:
- ▷ The door has to close properly
  - ▷ The unit door must not butt against the unit body
  - ▷ The seal must have a firm fit at the upper corner on the handle side. To check, darken the room, place a torch inside the appliance at the top and close the door. If light shines through, check the assembly.

### 4.3 Transporting the appliance



#### CAUTION

Risk of injury and danger of damage as a result of incorrect transport!

- ▶ Transport the appliance in a packed condition.
- ▶ Transport the appliance upright.
- ▶ Do not transport the appliance without assistance.

### 4.4 Installing the appliance

In the event that the appliance is damaged, contact the supplier immediately before connecting to the mains.

The floor of the installation site must be level and smooth.

Do not install the appliance in a location where it is exposed to direct radiation of the sun, next to a cooker, heater and similar.

Do not install the appliance without assistance.

According to the EN 378 standard, the room in which your appliance is installed must have a volume of 1 m<sup>3</sup> per 8 g of R 600a refrigerant. If the room in which the appliance is installed is too small, a flammable gas-air mixture may form in the event of a leakage in the refrigeration circuit. The quantity of refrigerant used in your appliance is indicated on the type plate on the inside of the appliance.

Fit the appliance in stable kitchen units only.  
The following ventilation gaps must be observed:

- The depth of the ventilation channel at the rear of the unit must be at least 38 mm.
- The minimum cross sections of the ventilation spaces in the plinth and top of the furniture unit are 200 cm<sup>2</sup>.
- The principle applies: the larger the ventilation gap, the more energy-saving the appliance is in operation.



#### WARNING

Fire hazard due to dampness!

If live parts or the mains lead become damp this may cause short circuits.

- ▶ The appliance is designed for use in enclosed areas. Do not operate the appliance outdoors or in areas where it is exposed to splash water or damp conditions.



#### WARNING

Fire hazard due to refrigerant!

The refrigerant R 600a is environmentally friendly but flammable. Escaping refrigerant may ignite.

- ▶ Do not damage the pipes of the refrigeration circuit.



#### WARNING

Fire hazard and danger of damage!

- ▶ Do not place appliances emitting heat e.g. microwaves, toasters etc. on the appliance!

- ▶ Detach the connecting cable from the rear of the appliance, removing the cable holder because otherwise there will be vibratory noise!

After installation:

- ▶ Remove the protective film from the decorative trims and drawer fronts.
- ▶ Remove all transit supports.
- ▶ Dispose of packaging material. See section on packaging disposal.

#### ATTENTION

Risk of damage due to condensate!

If your appliance is not a Side-by-Side (SBS) appliance:

- ▶ do not install the appliance directly alongside a further refrigerator/freezer.

If the appliance is installed in a very damp environment, condensate may form on the outside of the appliance.

- ▶ Always see to good ventilation at the installation site.

### 4.5 Disposing of packaging



#### WARNING

Danger of suffocation due to packing material and plastic film!

- ▶ Do not allow children to play with packing material.

The packaging is made of recyclable materials:

- corrugated board/board
- EPS moulded parts
- polythene bags and sheets
- polypropylene straps

- ▶ Take the packaging material to an official collecting point.



### 4.6 Connecting the appliance

#### ATTENTION

Risk of damage to the electronic control system!

- ▶ Do not use a stand-alone inverter (DC/AC conversion) or energy-saving plug.

**WARNING**

Fire and overheating hazard!

- ▶ Do not use an extension cable or multiple socket outlet.

The type of current (alternating current) and voltage at the site of installation must conform with the data on the type plate (see section relating to the description of appliance and equipment).

Connect the appliance only with a properly installed socket outlet with earthing contact. The socket outlet must be fused with 10 A or higher.



- ▶ Check electrical connection.
- ▶ Clean the appliance. For details, see the section on cleaning.
- ▶ Plug in the power plug.

## 4.7 Switching on the appliance

**Note**

- ▶ To switch on the entire appliance it is necessary only to switch on the freezer compartment.

**Note**

- ▶ After switch-on, first the freezer compartment is cooled and after some time the refrigerator compartment.

Put the appliance into operation about 2 hours before first loading food to be frozen.

Do not load food to be frozen before the temperature display reads -18 °C.

### 4.7.1 Switching on the freezer compartment

- ▶ Press On/Off button, freezer compartment *Fig. 2 (3)*.
- ▷ The refrigerator compartment temperature display indicates the set temperature.
- ▷ The freezer compartment temperature display and the alarm button flash until the temperature is sufficiently cold. If the temperature is above 0 °C, dashes flash. If it is below, the current temperature flashes.

### 4.7.2 Switching on refrigerator and BioFresh compartment

- ▶ Press On/Off button, refrigerator compartment *Fig. 2 (11)*.
- ▷ The interior light is on when the door is open.
- ▷ The temperature display shines. Refrigerator and BioFresh compartment are switched on.
- ▷ The temperature displays shine. Refrigerator and BioFresh compartment and freezer compartment are switched on.

## 5 Control

### 5.1 Saving energy

- ▶ Always make sure there is good ventilation.
- ▶ Keep the time the appliance is open to a minimum.
- ▶ Store food logically.
- ▶ Allow warm food to cool to room temperature before placing it inside.
- ▶ Defrost frozen food in the refrigerator.  
If there is a thick layer of frost in the appliance:  
▶ defrost the appliance.\*

### 5.2 Brightness of the temperature display

You can adjust the brightness of the temperature display to the light conditions of the room in which the appliance is installed.

### 5.2.1 Adjusting the brightness

The brightness is adjustable between h0 (no illumination) and h5 (maximum luminosity).

- ▶ To activate the setting mode: press the SuperFrost button *Fig. 2 (2)* for about 5 s.
- ▷ The display indicates c.
- ▷ The SuperFrost button flashes.
- ▶ Using the Up setting button, freezer compartment *Fig. 2 (5)* or Down setting button, freezer compartment *Fig. 2 (4)* select h.
- ▶ To confirm: briefly press the SuperFrost button *Fig. 2 (2)*.
- ▶ To set the display brighter: press the Up setting button, freezer compartment *Fig. 2 (5)*.
- ▶ To set the display darker: press the Down setting button, freezer compartment *Fig. 2 (4)*.
- ▶ To confirm: press the SuperFrost button *Fig. 2 (2)*.
- ▷ The brightness is adjusted to the new value.
- ▶ To deactivate the setting mode: press the On/Off button, freezer compartment *Fig. 2 (3)*.

**-or-**

- ▶ Wait for 5 minutes.

- ▷ The temperature is indicated again in the temperature display.

### 5.3 Child proofing

The child-proofing function enables you to make sure that the appliance is not inadvertently switched off by playing children.

#### 5.3.1 Setting the child-proofing function

- ▶ To activate the setting mode: press the SuperFrost button *Fig. 2 (2)* for about 5 s.
- ▷ The display indicates c.
- ▷ The SuperFrost button flashes.
- ▶ Briefly press the SuperFrost button *Fig. 2 (2)* to confirm.
- ▶ To switch on: using the Up setting button, freezer compartment *Fig. 2 (5)* or Down setting button, freezer compartment, *Fig. 2 (4)* select c1.
- ▶ To switch off: using the Up setting button, freezer compartment *Fig. 2 (5)* or Down setting button, freezer compartment, *Fig. 2 (4)* select c0.
- ▶ To confirm: press the SuperFrost button *Fig. 2 (2)*.
- ▷ The child-proofing function is switched on when the child-proofing symbol *Fig. 2 (8)* shines.
- ▶ To deactivate the setting mode: press the On/Off button, freezer compartment *Fig. 2 (3)*.

**-or-**

- ▶ Wait for 5 minutes.

- ▷ The temperature is indicated again in the temperature display.

### 5.4 Door alarm

For refrigerator/BioFresh compartment and freezer compartment

If the door is open longer than 60 s, the audible alarm sounds.

The audible alarm is automatically silenced when the door is closed.

#### 5.4.1 Muting the door alarm

The audible alarm can be muted when the door is open. The sound switch-off function is active as long as the door is left open. When the door is closed, the alarm function is active again.

- ▶ Press alarm button *Fig. 2 (1)*.
- ▷ The door alarm is silenced.\*

### 5.5 Temperature alarm

The audible alarm sounds if the freezer temperature is not cold enough.

# Control

The temperature display flashes at the same time.  
The cause of the temperature being too high may be:

- warm fresh food was placed inside
- too much warm ambient air flowed in when rearranging and removing food
- power failure for some time
- the appliance is faulty

The audible alarm is automatically silenced and the temperature display stops flashing when the temperature is sufficiently cold again.

If the alarm status persists, proceed according to the section on troubleshooting.

## Note

Food may be spoilt if the temperature is not cold enough.  
▶ Check the quality of the food. Do not consume spoiled food.

### 5.5.1 Muting the temperature alarm

The audible alarm can be muted. When the temperature is sufficiently cold again, the alarm function is active again.

- ▶ Press alarm button *Fig. 2 (1)*.
- ▷ The audible alarm is silenced.

## 5.6 Refrigerator compartment

The natural circulation of air in the refrigerator compartment results in zones differing in temperature. It is coldest directly above the plate separating off the BioFresh zone and at the rear wall. It is warmest at the top front of the compartment and in the door.

### 5.6.1 Food refrigeration

- ▶ Store bakery products, dairy products, meat or mincemeat in the coldest zone. Place butter, eggs and preserves in the upper area and in the door. (see also the section on the appliance at a glance)
- ▶ Use recyclable plastic, metal, aluminium and glass containers and cling film for wrapping.
- ▶ Use the front floor area of the refrigerator compartment only to temporarily set food down, e.g. when rearranging or sorting the contents. Do not leave food there as it may be pushed back or tipped over when the door is closed.
- ▶ Do not store food too close together to enable good air circulation.
- ▶ To ensure the bottles do not tip over: move the bottle holder.

At the base of the refrigerator compartment, the integrated bottle shelf or alternatively the glass shelf can be used:

- ▶ Using the bottle shelf: store the glass shelf under the bottle shelf to save space.
- ▶ Place the bottles with the base pointing backwards facing the rear wall. If the bottles project beyond the bottle shelf:
- ▶ set the lower door rack one position higher.

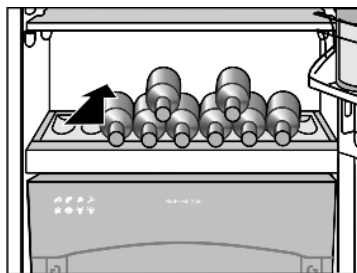

### 5.6.2 Setting the temperature in the refrigerator compartment

The temperature can be set from 9 °C to 4 °C / Australian model 9 °C to 3 °C, the recommended temperature is 5 °C.

## Note

If the temperature is to be colder than 4 °C:

- ▶ Set the cooling temperature to 4 °C.
- ▶ Set the BioFresh temperature to a value between b4 (slightly colder) and b1 (coldest) (see section on setting the temperature in the BioFresh compartment)

- ▶ To set the temperature warmer: press the Up setting button, refrigerator compartment *Fig. 2 (10)*.
- ▶ To set the temperature colder: press the Down setting button, refrigerator compartment *Fig. 2 (9)*.
- ▷ When the button is pressed the first time, the previous value is indicated in the temperature display, refrigerator compartment.
- ▶ To change the temperature in 1 °C steps: briefly press the button.
- ▶ To change the temperature continuously: hold down the button.
- ▷ The value is displayed flashing during the setting operation.
- ▷ The actual temperature is displayed about 5 s after the last press of a button. The temperature slowly adjusts to the new value.

### 5.6.3 SuperCool

With SuperCool you switch to the highest refrigerating performance to reach lower cooling temperatures. Use SuperCool to rapidly cool large amounts of food.

The SuperCool function uses slightly more energy.

#### Cooling with SuperCool

- ▶ Briefly press SuperCool button *Fig. 2 (12)*.
- ▷ The SuperCool button *Fig. 2 (12)* lights up.
- ▷ The cooling temperature drops to its lowest value. SuperCool is activated.
- ▷ SuperCool is automatically deactivated after about 6 h. The appliance continues to operate in the energy-saving, normal mode.

#### To prematurely deactivate SuperCool

- ▶ Briefly press SuperCool button *Fig. 2 (12)*.
- ▷ The SuperCool button *Fig. 2 (12)* goes out.
- ▷ SuperCool is deactivated.

### 5.6.4 Relocating the shelves

The shelves have stops preventing them from being unintentionally pulled out.

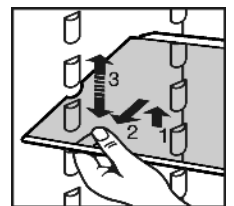

- ▶ Insert shelf with the raised edge pointing upwards at the back.
- ▷ The food does not freeze onto the rear wall.

### 5.6.5 Using sectioned shelf

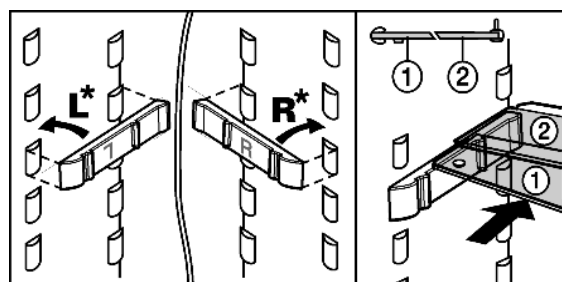

*Fig. 32*

- ▶ Attach accompanying support rails, paying attention to the right (R) and left (L) part!\*
- ▶ The glass shelf with raised edge (2) has to be at the back.
- ▶ For cleaning, remove the support rails for the glass shelf halves.

### 5.6.6 Moving the storage rack

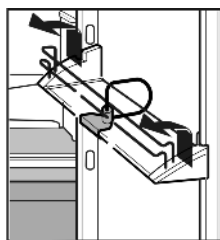

Always remove the butter and cheese compartment together with the lid.

- ▶ To remove lid: Press one side of the butter and cheese compartment outwards until the lid pin is free, then remove the lid sideways.

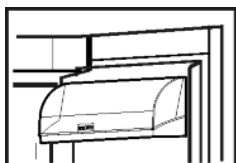

### 5.6.7 Removing the bottle holder

- ▶ Always take hold of the bottle holder on the plastic part.

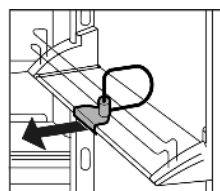

## 5.7 BioFresh compartment

The BioFresh compartment allows some types of fresh food to be stored up to three times longer than in conventional refrigerators, without compromising quality.

For food with an indicated best before date, the date specified on the packaging always applies.

### 5.7.1 HydroSafe

The HydroSafe at the moist setting is suited for storing unwrapped salad, vegetables and fruit with high inherent moisture. When the drawer is well filled, a dewy climate with up to 90% humidity is established. The humidity in the compartment depends on the moisture content of the food stored and on the opening frequency. You can set the humidity yourself.

### 5.7.2 DrySafe

The DrySafe is suitable for storing dry or wrapped food (e.g. dairy products, meat, fish, sausages). A relatively dry storage climate is established here.

### 5.7.3 Storing food

#### Note

- ▶ No vegetables sensitive to cold, such as cucumbers, aubergines, avocados, semi-ripe tomatoes, beans and courgettes, or any tropical fruits sensitive to cold belong in the BioFresh compartment.

- ▶ Store unwrapped plant and animal products separately in the drawers to prevent spoilage due to the transfer of germs. This also applies to different sorts of meat.

- ▶ If food has to be stored together due to lack of space: wrap the food.

### 5.7.4 Storage times

Standard values for storage time at low humidity			
Butter	up to	90	days
Hard cheese	up to	110	days
Milk	up to	12	days
Sausage, cold meat	up to	9	days
Poultry	up to	6	days
Pork	up to	7	days
Beef	up to	7	days
Game	up to	7	days

#### Note

- ▶ Please note that protein-rich food deteriorates faster, i.e. shellfish and crustaceans deteriorate faster than fish and fish faster than meat.

Standard values for storage time at high humidity			
Vegetables, salad			
Artichokes	up to	14	days
Celery	up to	28	days
Cauliflower	up to	21	days
Broccoli	up to	13	days
Chicory	up to	27	days
Lamb's lettuce	up to	20	days
Peas	up to	14	days
Kale	up to	14	days
Carrots	up to	80	days
Garlic	up to	160	days
Kohlrabi	up to	55	days
Lettuce	up to	13	days
Herbs	up to	13	days
Leek	up to	29	days
Mushrooms	up to	7	days
Radishes	up to	10	days
Brussels sprouts	up to	20	days
Asparagus	up to	18	days
Spinach	up to	13	days
Savoy cabbage	up to	20	days
Fruit			
Apricots	up to	13	days
Apples	up to	80	days
Pears	up to	55	days
Blackberries	up to	3	days
Dates	up to	180	days
Strawberries	up to	7	days
Figs	up to	7	days
Blueberries	up to	9	days
Raspberries	up to	3	days

Standard values for storage time at high humidity			
Currants	up to	7	days
Sweet cherries	up to	14	days
Kiwis	up to	80	days
Peaches	up to	13	days
Plums	up to	20	days
Cranberry	up to	60	days
Rhubarb	up to	13	days
Gooseberries	up to	13	days
Grapes	up to	29	days

## 5.7.5 Adjusting the temperature in the BioFresh compartment

The temperature is automatically regulated to between 0 °C and 3 °C, the recommended temperature is 1 °C.

You can adjust the temperature slightly colder or warmer. The temperature can be adjusted from b1 (coldest temperature) to b9 (warmest temperature). The presetting is b5. At the b1 to b4 settings the temperature may drop below 0 °C and therefore the food may freeze slightly.

- ▶ To activate the setting mode: press the SuperFrost button *Fig. 2 (2)* for about 5 s.
- ▷ The SuperFrost button flashes.
- ▷ The temperature display indicates: c
- ▶ Press the Up setting button, freezer compartment *Fig. 2 (5)* the number of times required for b to flash in the display.
- ▶ To confirm: briefly press the SuperFrost button.
- ▶ For a colder temperature adjustment: press Down setting button, freezer compartment *Fig. 2 (10)*.
- ▶ To confirm: press SuperFrost button.
- ▷ The temperature slowly adjusts to the new value.





- ▶ To deactivate the setting mode: press the On/Off button, freezer compartment *Fig. 2 (3)*.

-or-

- ▶ Wait for 5 minutes.
- ▷ The temperature is indicated again in the temperature display.

## 5.7.6 Setting the humidity in the HydroSafe

- ▶  low humidity: slide the controller to the left.
- ▶  high humidity: slide the controller to the right.



## 5.7.7 Drawers

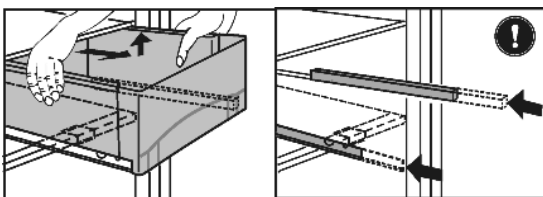

*Fig. 33*

- ▶ Remove drawers as illustrated.
- ▶ To remove drawer cover: once the drawers have been removed, carefully pull the drawer cover *Fig. 34 (2)* with humidity control forwards and lower it for removal.

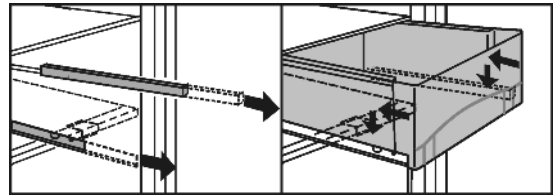

*Fig. 34*

- ▶ Insert drawer as illustrated.
- ▶ To insert drawer cover *Fig. 33 (2)*: insert the bars of the drawer cover into the rear holders from below and snap into the holder at the front.

## 5.8 Freezer compartment

You can store frozen food, make ice cubes and freeze fresh food in the freezer compartment.

### 5.8.1 Freezing food

The maximum load of frozen food for a single drawer or shelf is 25 kg.

A vacuum is generated after the door is closed. Wait for about 1 minute after closing the door, then it opens easier.



#### CAUTION

Risk of injury due to broken glass!  
Bottles and cans containing drinks may burst when being frozen. This applies particularly to sparkling drinks.

- ▶ Do not freeze bottles and cans containing drinks!

In order that the food is rapidly frozen through to the core, do not exceed the following quantities per pack:

- fruit and vegetables up to 1 kg
- meat up to 2.5 kg
- ▶ Pack the food in portions in freezer bags, reusable plastic, metal or aluminium containers.

### 5.8.2 Thawing food

- in the refrigerator compartment
- at room temperature
- in a microwave oven
- in a conventional or fan oven
- ▶ Food once thawed should be re-frozen only in exceptional cases.

### 5.8.3 Setting the temperature in the freezer compartment

The appliance is pre-set for normal operation.

The temperature in the freezer compartment can be set from -16 °C to -26 °C, the recommended temperature is -18 °C.

- ▶ To set the temperature warmer: press Up setting button, freezer compartment *Fig. 2 (5)*.
- ▶ To set the temperature colder: press Down setting button, freezer compartment *Fig. 2 (4)*.
- ▷ When the button is pressed the first time, the previous value is indicated in the temperature display of the freezer compartment.
- ▶ To change the temperature in 1 °C steps: briefly press the button.

-or-

- ▶ To change the temperature continuously: hold down the button.
- ▷ The value is displayed flashing during the setting operation.
- ▷ The actual temperature is displayed about 5 s after the last press of a button. The temperature slowly adjusts to the new value.

### 5.8.4 SuperFrost\*

With this function you can freeze fresh food quickly through to the core. The appliance operates with maximum refrigerating performance. The sound of the refrigeration unit may be temporarily louder as a result.

In addition, frozen food already in storage is given a "cold reserve". The food stays frozen longer as a result when you defrost the appliance.\*

The maximum number of kilograms of fresh food you can freeze within 24 hours is indicated on the type plate under "freezing capacity ... kg/24h". This amount varies according to the model and climate rating.

#### Freezing with SuperFrost

You do not have to activate SuperFrost in the following cases:

- when placing frozen food in the freezer
- when freezing up to about 2 kg fresh food daily
- ▶ Briefly press the SuperFrost button *Fig. 2 (2)* once.
- ▷ The SuperFrost button *Fig. 2 (2)* shines.
- ▷ The freezer temperature drops, the appliance operates with the maximum refrigerating capacity.
- In case of a small amount of food to be frozen:
  - ▶ wait about 6 h.
  - ▶ Place the fresh food in the top drawers.
- In case of the maximum amount of food to be frozen:
  - ▶ wait about 24 h.
  - ▶ Place wrapped food straight onto the shelves and put it into the drawers once it has frozen.
- ▷ SuperFrost is automatically deactivated. At the earliest after 30 h, at the latest after 65 h, depending on quantity placed inside.
- ▷ Freezing is concluded.
- ▷ The SuperFrost button *Fig. 2 (2)* is dark.
- ▷ The appliance continues to operate in the energy-saving, normal mode.

### 5.8.5 Drawers

#### Note\*

The energy consumption increases and the cooling performance decreases if the ventilation is insufficient.

For appliances with NoFrost:

- ▶ Leave the bottom drawer in the appliance!
- ▶ Always keep the air slits of the fan free at the rear wall!

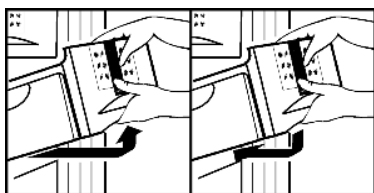

- ▶ To store frozen food directly on the shelves: pull drawer forwards and lift it for removal.

### 5.8.6 Shelves

- ▶ To remove shelf: lift it at the front and pull it out.
- ▶ To insert shelf: simply slide it in to the limit.

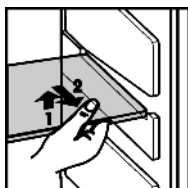

### 5.8.7 VarioSpace

Apart from being able to remove the drawers, you can also remove the shelves, creating space for large frozen food. Poultry, meat, large pieces of game and high bakery products can be frozen in one piece and prepared.

- ▶ Do not load a single drawer or the shelf with more than 25 kg frozen food.

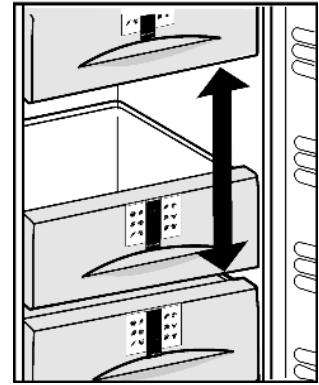

### 5.8.8 Information system

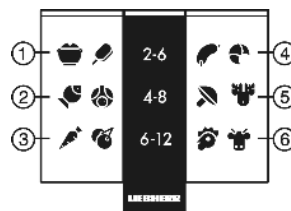

Fig. 35

- (1) Pre-cooked meals, ice cream
- (2) Pork, fish
- (3) Fruit, vegetables
- (4) Sausages, bread
- (5) Game, mushrooms
- (6) Poultry, beef/veal

The figures indicate the storage time in months for several types of frozen food in each case. Storage times given are guide times.

### 5.8.9 Freezer tray

The freezer tray allows you to freeze berries, herbs, vegetables and other small items of food without them sticking together. Items being frozen will largely retain their shape, and it will be easier to remove exactly the right quantity later on.

In addition, you can store the cold storage accumulators in the freezer tray to save space.

#### Using the freezer tray

- ▶ Spread the items out loosely on the freezer tray.
- ▶ Attach the freezer tray in one of the upper drawers.
- ▶ Allow the food to freeze through for 10 to 12 h.
- ▶ Transfer the frozen food to freezer bags or containers.
- ▶ Store freezer bags or containers in a drawer.
- ▶ To defrost, spread the items out loosely again.

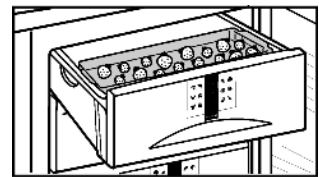

### 5.8.10 Cold storage accumulators

The cold storage accumulators prevent the temperature from rising too quickly in case of power failure.

#### Cold storage accumulators

You can freeze and store the cold storage accumulators either in the freezer tray or in the ceiling of the freezer compartment, depending on type of appliance.\*

It is possible for cold storage accumulators to be frozen in the ceiling only in appliances without NoFrost module!\*

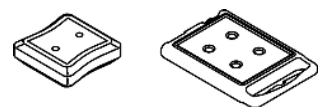

# Maintenance

With the top drawer removed:

- ▶ to insert cold storage accumulators: slide cold storage accumulator into the top back of the freezer compartment ceiling and snap into place at the front.

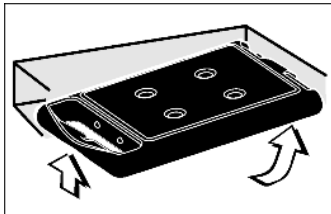

With the top drawer removed:

- ▶ to remove cold storage accumulators: take hold of the cold storage accumulator at the side and press it down for removal.

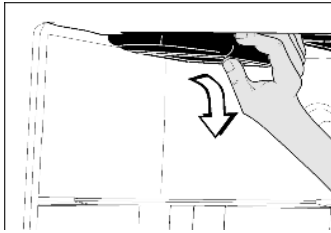

## 6 Maintenance

### 6.1 Manual defrosting\*

The **refrigerator compartment** is defrosted automatically. The defrost water evaporates as a result of the heat of the compressor. Drops of water on the rear wall are perfectly normal.

- ▶ Regularly clean the drain opening to allow the water to flow away. (see section on cleaning)

A layer of frost or ice can build up in the **freezer compartment** after a long period of operation.

The layer of frost or ice builds up faster if the appliance is opened often or if the food is warm when placed inside. However, a thick layer of ice will increase the appliance's energy consumption. You should therefore defrost the appliance regularly.



#### CAUTION

Risk of injury and damage as a result of hot steam!

- ▶ Do not use electric heaters or steam cleaners, naked flames or defrosting sprays for defrosting.
- ▶ Do not remove ice using sharp instruments.

- ▶ Switch on SuperFrost one day before defrosting.
- ▷ The frozen goods are provided with a "cold reserve".
- ▶ Switch off the appliance.
- ▷ The temperature display goes out.
- ▷ If the temperature display does not go out, the child lock function (see section on child lock) is active.
- ▶ Pull out the power plug or switch off the fuse.
- ▶ Place cold storage accumulators on top of the frozen food.
- ▶ If possible, put the frozen goods in the freezer drawer, wrapped in newspaper or a blanket, and store in a cool place.
- ▶ Place a pan with hot, not boiling water on a middle shelf.

-or-

- ▶ Half-fill the two lower drawers with lukewarm water and put them in the appliance.



- ▷ Defrosting is speeded up.
- ▷ Defrost water is collected in the drawers.
- ▶ Leave the door of the appliance open while defrosting.
- ▶ Remove detached pieces of ice.
- ▶ Pay attention that the defrost water does not run into the kitchen unit.
- ▶ If necessary, pick up defrost water several times, using a sponge or cloth.
- ▶ Clean the appliance (see section on cleaning) and rub dry.

### 6.2 Defrosting with NoFrost\*

The NoFrost system automatically defrosts the appliance.

#### Refrigerator compartment:

The defrost water evaporates as a result of the heat of the compressor. Drops of water on the rear wall are perfectly normal.

- ▶ Regularly clean the drain opening to allow the water to flow away. (see section on cleaning)

#### Freezer compartment:

The moisture condenses on the evaporator, is periodically defrosted and evaporates.

- ▶ The appliance does not have to be manually defrosted.

## 6.3 Cleaning the appliance

#### Before cleaning:



#### CAUTION

Risk of injury and damage as a result of hot steam!

Hot steam may damage the surfaces and cause burns.

- ▶ Do not use any steam cleaners!

#### ATTENTION

Incorrect cleaning damages the appliance!

- ▶ Do not use cleaning agents in concentrated form.
- ▶ Do not use any scouring or abrasive sponges or steel wool.
- ▶ Do not use any cleaning agents containing sand, chloride, chemicals or acid.
- ▶ Do not use chemical solvents.
- ▶ Do not damage or remove the type plate on the inside of the appliance. It is important for the customer service.
- ▶ Do not pull off, bend or damage cables or other components.
- ▶ Do not allow any cleaning water to enter the drain channel, ventilation grille or electrical parts.

- ▶ Empty appliance.

- ▶ Pull out the plug.

- Use soft cleaning cloths and a multi-purpose cleaning agent with neutral pH value.
- Only use food compatible cleaning and care agents on the inside of the appliance.



#### Outside surfaces and interior:

- ▶ Clean the plastic surfaces, outside and inside, by hand using lukewarm water and a little washing-up liquid.
- ▶ To clean drain opening: remove deposits using a thin instrument, e.g. a cotton bud.

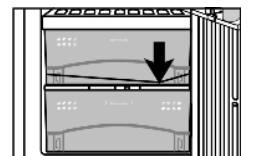

#### Items of equipment:

- ▶ Clean butter dish in the dishwasher.
- ▶ Clean other items of equipment by hand with lukewarm water and a little washing-up liquid.
- ▶ Dismantling shelves: remove trims and side parts.
- ▶ Dismantling storage racks: remove protective films from the trims.

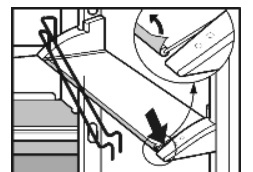

#### After cleaning:

- ▶ Wipe dry the appliance and items of equipment.
- ▶ Connect the appliance and switch it on again.
- ▶ Activate SuperFrost . (see section on SuperFrost)
- ▶ When the temperature is sufficiently cold:
- ▶ Put the food back inside.

## 6.4 Customer service

First check whether you can correct the fault yourself by reference to the list in the section on troubleshooting. If this is not the case, please contact the customer service whose address is given in the enclosed customer service list.



### WARNING

Risk of injury if repair work is not carried out professionally!

- ▶ Have any repairs to and intervention in the appliance and mains power cable, which are not expressly mentioned in the section on maintenance, carried out by the customer service only.

- ▶ Read the appliance designation *Fig. 36 (1)*, service No. *Fig. 36 (2)* and serial No. *Fig. 36 (3)* off the type plate located inside the appliance on the left-hand side.

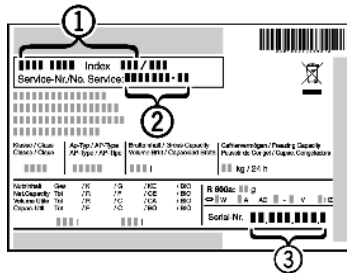

Fig. 36

- ▶ Notify the customer service, specifying the fault, appliance designation *Fig. 36 (1)*, service No. *Fig. 36 (2)* and serial No. *Fig. 36 (3)*.
- ▷ This will help us to provide you with a faster and more accurate service.
- ▶ Keep the appliance closed until the customer service arrives.
- ▷ The food will stay cool longer.
- ▶ Pull out the mains plug (not by pulling the connecting cable) or switch off the fuse.

## 7 Malfunction

Your appliance is designed and manufactured for a long life span and reliable operation. If a malfunction nonetheless occurs during operation, check whether it is due to a handling error. In this case you will have to be charged for the costs incurred, even during the warranty period. You may be able to rectify the following faults yourself:

### Appliance does not work.

- The appliance is not switched on.
- ▶ Switch on the appliance.
- The power plug is not properly inserted in the wall socket.
- ▶ Check power plug.
- The fuse of the wall socket is not in order.
- ▶ Check fuse.

### The compressor runs for a long time.

- The compressor switches to a low speed when little cold is needed. Although the running time is increased as a result, energy is saved.
- ▶ This is normal in energy-saving models.
- SuperFrost is activated.
- ▶ For compressor runs for longer in order to rapidly cool the food. This is normal.
- SuperCool is activated.
- ▶ For compressor runs for longer in order to rapidly cool the food. This is normal.

### A bubbling and gurgling sound

- This sound comes the refrigerant flowing in the refrigeration circuit.
- ▶ The sound is normal.

### A faint clicking sound

- The sound is always produced when the refrigeration unit (the motor) automatically switches on or off.
- ▶ The sound is normal.

### A hum. It is briefly a little louder when the refrigeration unit (the motor) switches on.

- The refrigeration increases automatically when the SuperFrost function is activated, fresh food has just been placed in the appliance or the door has been left open for a while.
- ▶ The sound is normal.
- The refrigeration increases automatically when the SuperCool function is activated, fresh food has just been placed in the appliance or the door has been left open for a while.
- ▶ The sound is normal.
- The ambient temperature is too high.
- ▶ See section on range of appliance use

### Vibratory sound

- The appliance is not standing firmly on the floor. As a result, adjoining units or objects are set into vibration by the running refrigeration unit.
- ▶ Move bottles and containers apart.

### Flow noise at the soft stop system.\*

- The sound is caused by the soft stop mechanism.
- ▶ The sound is normal

### The temperature display reads: F0 to F5.

- There is a fault.
- ▶ Contact the customer service. See the section on maintenance.

### The temperature display reads: nR

- The freezer temperature rose too high over the last hours or days due to a power failure or power interruption. When the power interruption is over, the appliance will continue to operate in the last temperature setting.
- ▶ Press alarm button *Fig. 2 (1)*.
- ▷ The warmest temperature reached during the power failure will appear in the temperature display for about 60 s. After that, the actual temperature in the freezer will re-appear.
- ▶ To delete the display of the warmest temperature ahead of time: press the alarm button *Fig. 2 (1)*.
- ▶ Check the quality of the food. Do not consume spoiled food. Do not re-freeze thawed food.

### The temperature is not cold enough.

- The door of the appliance is not properly closed.
- ▶ Close the appliance door.
- Insufficient ventilation.
- ▶ Clear ventilation grilles.
- The ambient temperature is too high.
- ▶ See the section on the range of appliance use.
- The appliance was opened too frequently or for too long.
- ▶ Wait until the appliance reaches the required temperature itself. If not, contact the customer service. See the section on maintenance.
- Too much fresh food was placed inside without SuperFrost.
- ▶ See section on SuperFrost.
- The temperature is incorrectly set.
- ▶ Set to a colder temperature and check after 24 h.
- The appliance is too close to a heat source.
- ▶ See the section on installation.

### The interior light is not on.

- The appliance is not switched on.
- ▶ Switch on the appliance.
- The door was open longer than 15 min.
- ▶ The interior light automatically switches off if the door has been open for about 15 min.
- The LED interior light is faulty or the cover is damaged.

# Decommissioning

---



## WARNING

Risk of injury due to electric shock!

Live parts are located under the cover.

- ▶ Have the LED interior light replaced or repaired only by the customer service or by qualified personnel trained for the purpose.



## WARNING

Danger of injury due to laser radiation, class 1M.

- ▶ Do not look inside when the cover is open.

→ The LED freezer compartment lighting does not shine.

- ▶ You can change the light unit yourself. The spare part is available from the customer service. See section on maintenance

## 8 Decommissioning

### 8.1 Switching off the appliance

---

#### Note

- ▶ To switch off the entire appliance, it is necessary only to switch off the freezer compartment.

#### 8.1.1 Switching off the freezer compartment

- ▶ Press On/Off button, freezer compartment *Fig. 2 (3)* for about 2 s.
- ▷ The temperature displays are dark. The appliance is switched off.

#### 8.1.2 Switching off the refrigerator compartment with BioFresh compartment

---

#### Note

- ▶ The refrigerator compartment can be switched off separately, if required.
- ▶ Press On/Off button, refrigerator compartment *Fig. 2 (11)* for about 2 s.
- ▷ The temperature display of the refrigerator compartment *Fig. 2 (7)* is dark. The refrigerator compartment and BioFresh compartment are switched off.

### 8.2 Taking out of service

- ▶ Empty the appliance.
- ▶ Pull out the plug.
- ▶ Clean the appliance (see section on cleaning).



- ▶ Leave the door open to prevent odour.

## 9 Disposing of the appliance

The appliance contains some reusable materials and should be disposed of properly - not simply with unsorted household refuse. Appliances which are no longer needed must be disposed of in a professional and appropriate way, in accordance with the current local regulations and laws.



When disposing of the appliance, ensure that the refrigeration circuit is not damaged to prevent uncontrolled escape of the refrigerant it contains (data on type plate) and oil.

- ▶ Disable the appliance.
- ▶ Pull out the plug.
- ▶ Cut through the connecting cable.