

DELLA®

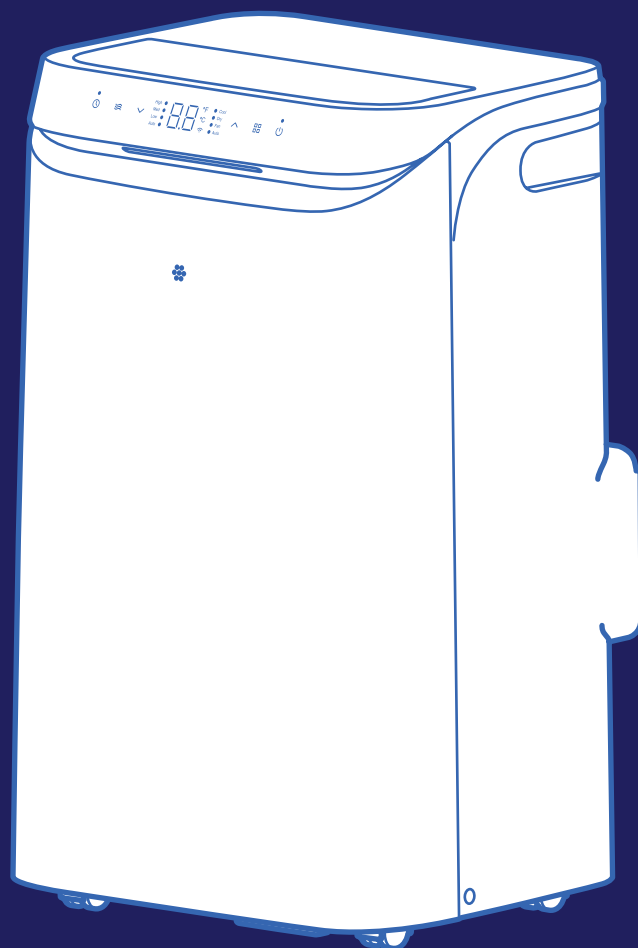

Portable AC

Instruction Manual
Installation and Operation Guide



Table of Content

Before Installation

Warning and Safety	04
Name of Parts	07
Product Specification	09

Installation

Installation Preview	10
Installation	12

Before Using

Operation Tips	17
Front Panel	18
Remote Control	19

Basic Operation

Power ON / OFF	21
Operation Modes	21
- Cool, Dry, Fan, Auto	21
Change Temperature	21
Change Humidity Target	21
Change Fan Speed	21
Swing Function	22
Timer	22

Advance Function

Sleep Mode	23
Turbo Mode	23
Display & LED ON / OFF	23
°F / °C	24
Wi-Fi Reset	24
Child Lock	24
Clean Filter Reminder	24
Default Reset	24
Wi-Fi Pairing	25

Care and Maintenance

Water Drainage	26
Air Filter	27
Maintenance Routine	28

Having Problems?

Troubleshooting	29
Disposal Guideline	31
Warranty	32

Warning and Safety

- Read this guide before installation. Failure to follow the safety instructions may result in property damage, serious injury, or death.
- Please Keep this manual.



Danger:

Indicates an **IMMINENTLY** hazardous situation that, if not avoided, will result in death, serious injury, or serious property damage.



Warning:

Indicates an **POTENTIALLY** hazardous situation that, if not avoided, will result in death, serious injury, or serious property damage.



Caution:

Indicates an **POTENTIALLY** hazardous situation that, if not avoided, will result in minor to moderate injury. It may also be used to indicate unsafe practice.



Attention:

Pay additional attention to the instruction.



DO NOT:

Indicates prohibited actions and / or practice.

About Refrigerant



- The air conditioner is pre-charged with refrigerant. Handle the air conditioner with care and check if there is any refrigerant leakage during installation. Refrigerants have no odor and can be toxic and flammable. Rapid evaporation of refrigerant may cause frostbite, cardiac arrhythmia, and / or irritation, as well as cause environmental damage.



- In the case of refrigerant leakage, shut down the appliance and disconnect from the power supply. An inspection must be performed by a qualified technician.



- When Installing or using the appliance with R32 refrigerant, beware of the following symbols displayed on the unit.



- This symbol means this appliance uses a flammable refrigerant. If the refrigerant is leaked and exposed to an external ignition source, there is a risk of fire.



- This symbol means that read the operation instruction carefully.









- This symbol means that personnel handling the equipment should reference to the installation manual.



- This symbol means information is available in the installation or operation instruction manual.



Warning and Safety



About Installation	
 WARNING 	<ul style="list-style-type: none"> ▪ Do not install or use this appliance in the bathroom, laundry area, or places that might come into contact with water. ▪ Do not install or use this appliance near flammable substances such as alcohol, gasoline, paint, etc. Or pressurized containers such as spray cans. ▪ Do not store, install or use this appliance in a room with continuously operating ignition sources such as open flames, gas appliances, or electric heater. ▪ Do not alter, change, or modify the appliance.
 CAUTION	<ul style="list-style-type: none"> ▪ Before installation, make sure the AC system is placed on a flat and stable platform in its upright position for at least 6 hours to prevent lubricating oil from damaging the compressor. ▪ Prevent children from accessing the work area during installation to prevent unforeseeable accident. ▪ Carry out a test run after the installation. ▪ The appliance should not be installed in a location where the air outlet of the unit is obstructed. Obstruction of these opening may cause damage or malfunctions to the appliance. ▪ Wear protective gloves and clothing during installation to prevent cuts or injuries.



About Power and Electricity	
 WARNING 	<ul style="list-style-type: none"> ▪ Ensure that the power voltage corresponds to that stamped on the rating plate. ▪ Make sure this appliance is connected to a properly grounded power outlet to prevent electric shock.
 WARNING 	<ul style="list-style-type: none"> ▪ Do not bend, tug, or compress the power cord during installation to prevent damaging the power cord. Damaged electrical cord should be replaced by a qualified electrician. ▪ This appliance must be plugged directly into a wall power socket. Do not use power extensions and / or multi-socket modules for appliance installation.

Warning and Safety

Before Installation
Before Installation

About Operation	
 WARNING 	<ul style="list-style-type: none"> Do not disconnect the appliance from the power supply before shutting off the appliance. This might create a spark and potentially cause a fire. Do not place flammable substances near the appliance. Do not climb onto or place any objects on the appliance. Do not insert any objects into the appliance to prevent damage or injury. Do not obstruct the air inlet or outlet. Do not operate the appliance with wet hands.
 CAUTION	<ul style="list-style-type: none"> If the appliance is used in areas without the possibility of ventilation, precautions must be taken to prevent any leaks of refrigerant. Only use the appliance as instructed in this booklet. These instructions are not intended to cover every possible condition and situation. As with any electrical household appliance, common sense and caution are therefore always recommended for usage and maintenance. This appliance is designed and made for air conditioning in domestic environments only. It must not be used for any other purpose such as drying clothes or cooling foods. This appliance can be used by children aged from 8 years or above and persons with reduced physical, sensory, or mental capabilities, or lack of experience and knowledge if they have been given supervision or instruction concerning use of the appliance in a safe way and understand the hazards involved. Children shall not play with the appliance.

Encountering Troubles	
 WARNING 	<ul style="list-style-type: none"> In the case of the appliance emitting smoke, burning smell, leaking water, or making unusual noise, shut down the appliance and disconnect from the power supply immediately. Contact a qualified technician for inspection and repair.

About Handling and Maintenance	
 WARNING 	<ul style="list-style-type: none"> Do not attempt to disassemble, alter, or modify the appliance. Do not flush the air conditioner with water.
 WARNING	<ul style="list-style-type: none"> Repairs should be carried out by a professional or qualified technician only. Incorrect repair could expose the user to potential electric shock or other kinds of hazard. Before cleaning the unit, the appliance must be shut down and disconnect from the power supply for at least 5 minutes.

Name of Parts

Front

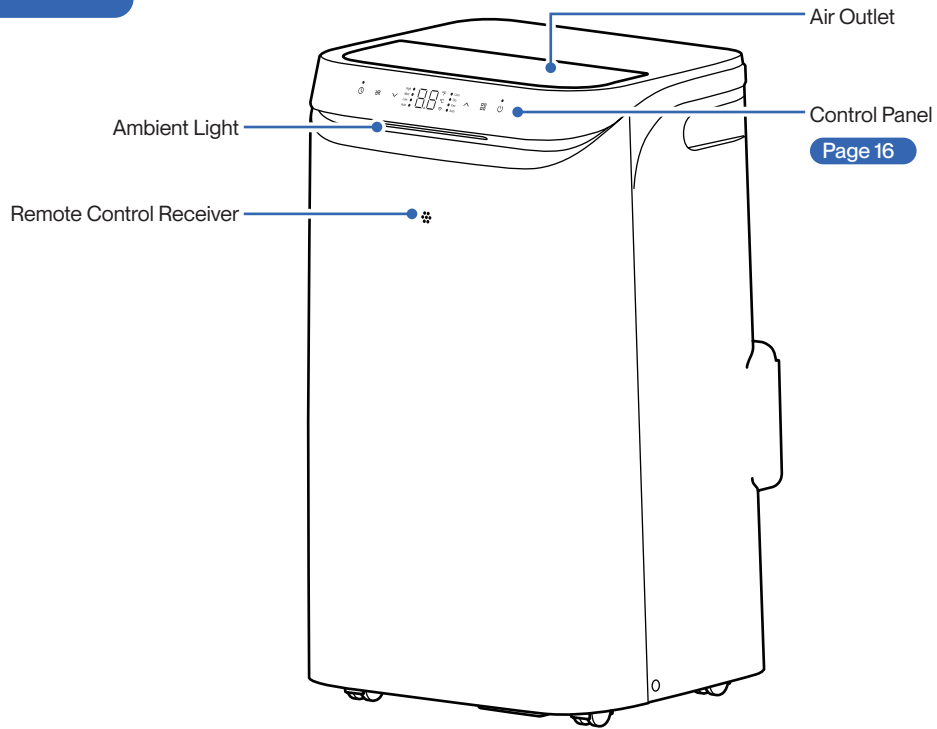

Back

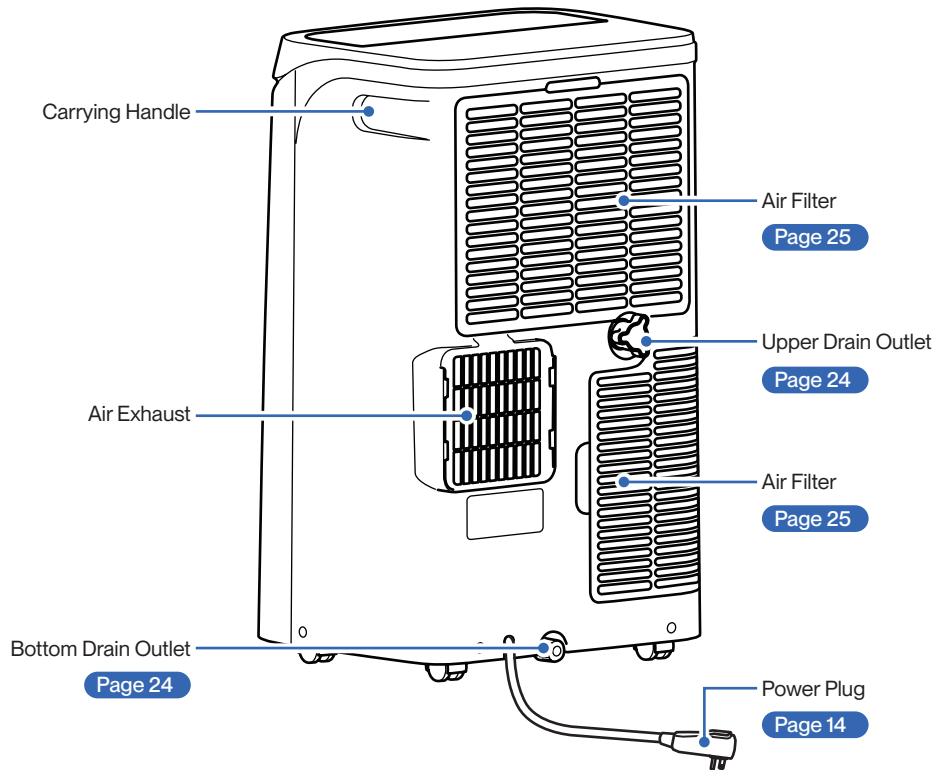

Before Installation
Before Installation



Name of Parts Package Contents



Foam Seal w/o adhesive
1x

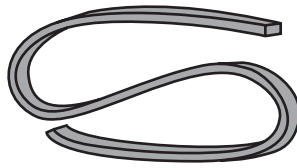

Foam Seal w adhesive
2x



Drain Hose
1x
ø14.60mm, Length 1000mm

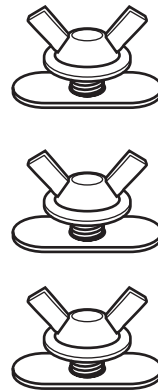
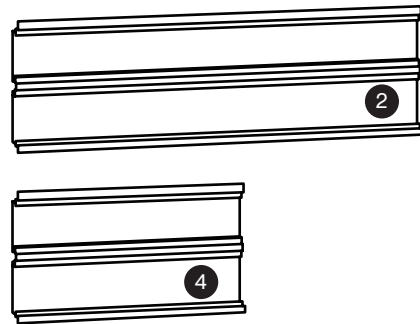
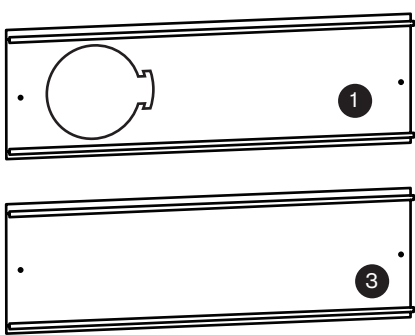

Window Bracket Set
1x

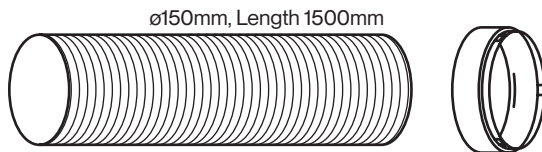
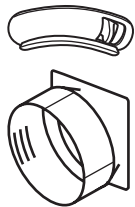

Exhaust Hose Set
1x
ø150mm, Length 1500mm

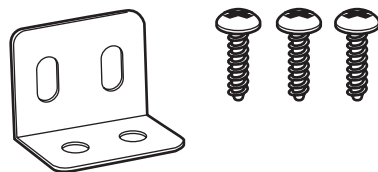

Sash Lock 1x
St3.9 x 14 Screw 3x

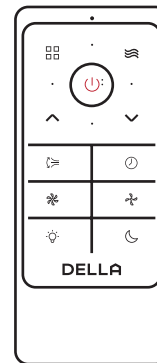

Remote Control 1x
CR2025 Battery 1x

Product Specification

	048-DPAC-8	048-DPAC-10
Power Supply	115 V / 60 Hz / 1P	115 V / 60 Hz / 1P
SACC Capacity (Btu/h)	8000	10000
CEER sd (Btu/Wh)	7.22	7.83
Rated Cooling Input Power	1060 W	1250 W
Rated Cooling Input Current	9.5 A	11.0 A
ASHRAE128 Capacity (Btu/h)	12000	14000
Rated Cooling Input Power	1250 W	1300 W
Rated Cooling Input Current	11.2 A	11.8 A
Noise Level	45 - 50 dB(A)	49 - 53 dB(A)
Dimension	14.02" x 16.65" x 27.13"	14.02" x 16.65" x 27.13"
Net Weight	56.8 lb	65.6 lb
Suitable Area	270 sq. ft	290 sq. ft
Moisture Removal (per hour)	3 pints	4 pints
Set Temp. Range	61°F - 86°F / 16°C - 30°C	61°F - 86°F / 16°C - 30°C
Operational Ambient Temp. Range	64°F - 95°F / 18°C - 35°C	64°F - 95°F / 18°C - 35°C
Refrigerant Type	R32	R32
Refrigerant Amount	9.52 oz	13.76 oz

Before Installation
Before Installation

Installation Info

Window Requirement

The air conditioner is designed to be installed in a standard single-hung, double-hung window or sliding window. The AC would not fit in other window types.

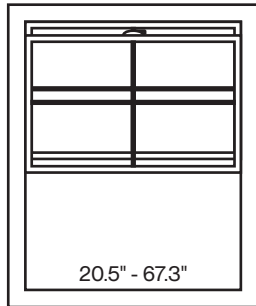

Single Hung / Double Hung Window

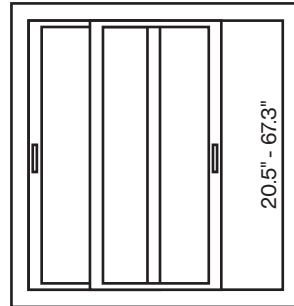

Sliding Window

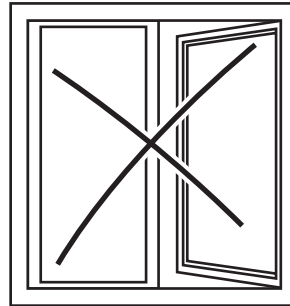

Casement Window

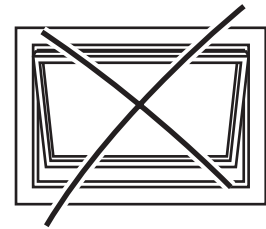

Awning Window

Window Bracket Combination

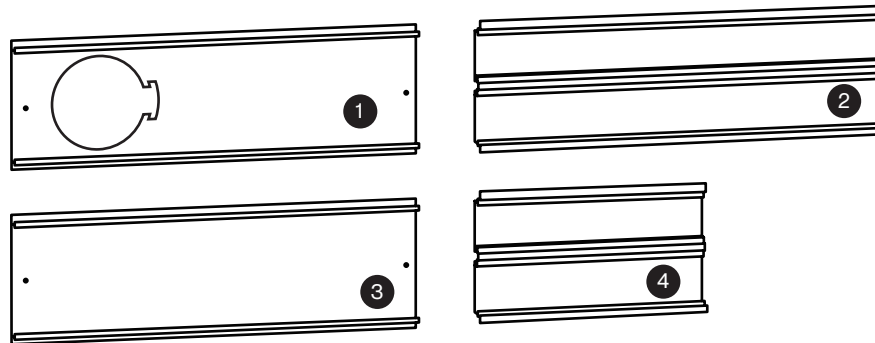

Window Opening Size	Window Bracket Panel to Use			
	1	2	3	4
20.5"	●			
20.5" - 30.3"	●			●
28.3 - 40"	●	●		
40.9" - 48.8"	●		●	●
40.9" - 57.5"	●	●	●	
40.9" - 67.3"	●	●	●	●

Installation Info



- Before installation, make sure the AC system is placed on a flat and stable platform in its upright position for at least 6 hours to prevent lubricating oil from damaging the compressor.

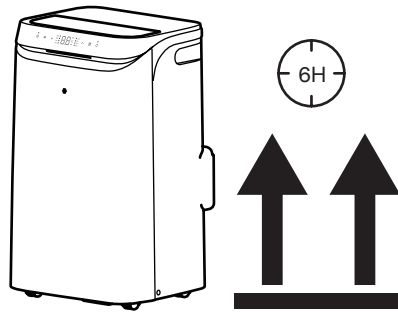

Picking a Installation Location

- The air conditioner must be placed on a flat ground.
- Keep the air conditioner at least 18" or 45cm from any wall or obstacles.
- Do not place the air conditioner in laundry room or near any open ignition sources such as open flames, gas appliance, or electric heater.
- The air conditioner should be placed near a window where exhaust hose need the least extended distance.

Clearance Requirement Around the Air Conditioner

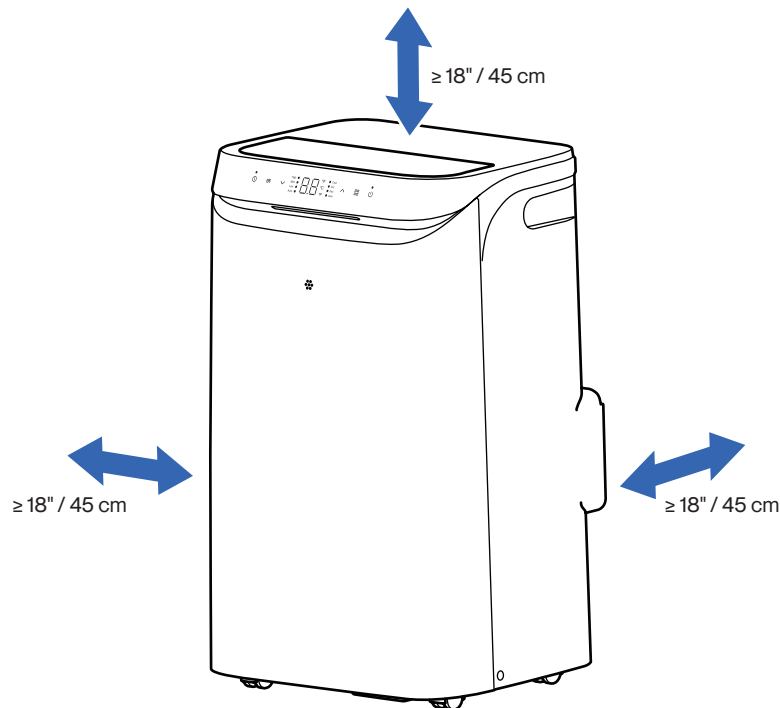

Installation

Connect the Exhaust Hose

1. Connect the hose connector to one end of the exhaust hose.
2. Connect the window board adapter to the other end of the exhaust hose.

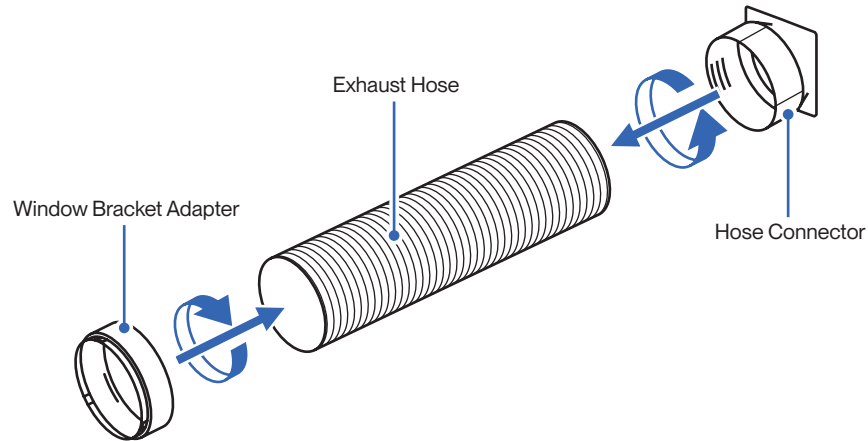

Extend the Window Bracket

1. Assemble the window bracket and adjust the length of it to fit your window frame.
2. Tighten the butterfly bolts on the board after the bracket is extended to your desired length.

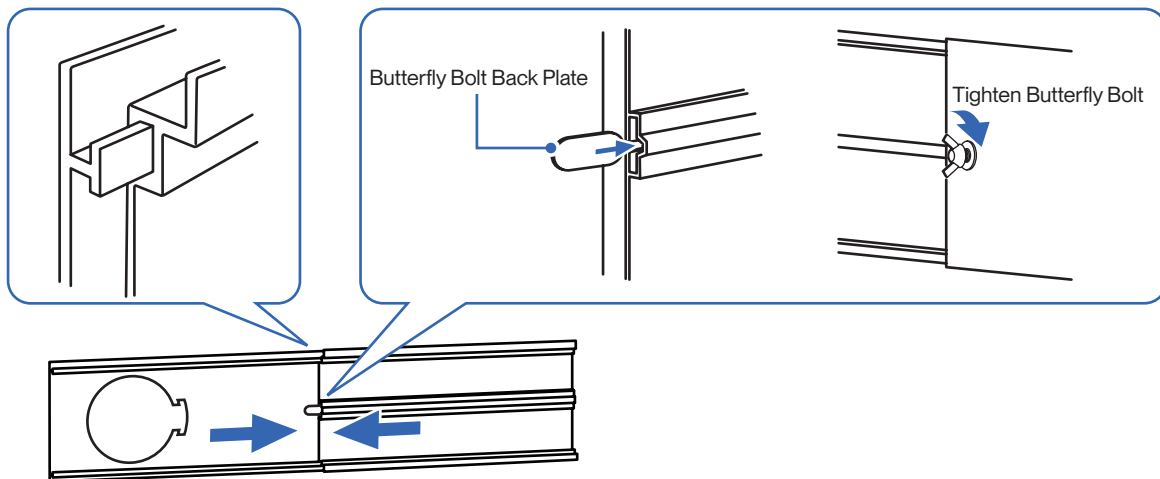
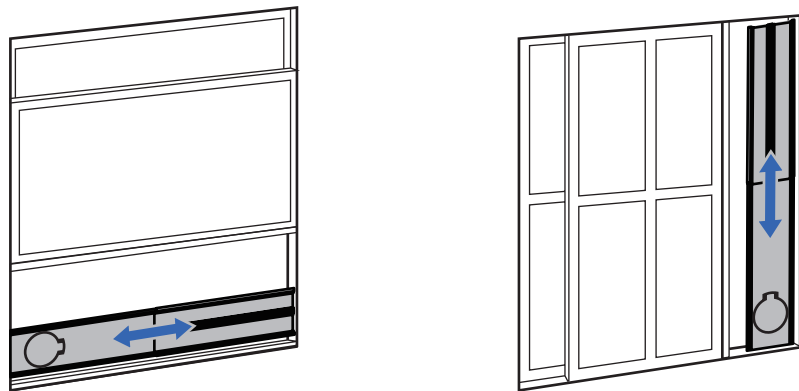

Installation

Attach Exhaust Hose to Air Conditioner

1. Slide the hose connector to the air exhaust port on the air conditioner.
2. Then attach the window bracket adapter to the window bracket.
3. Use the locking tab to lock the exhaust hose in place.

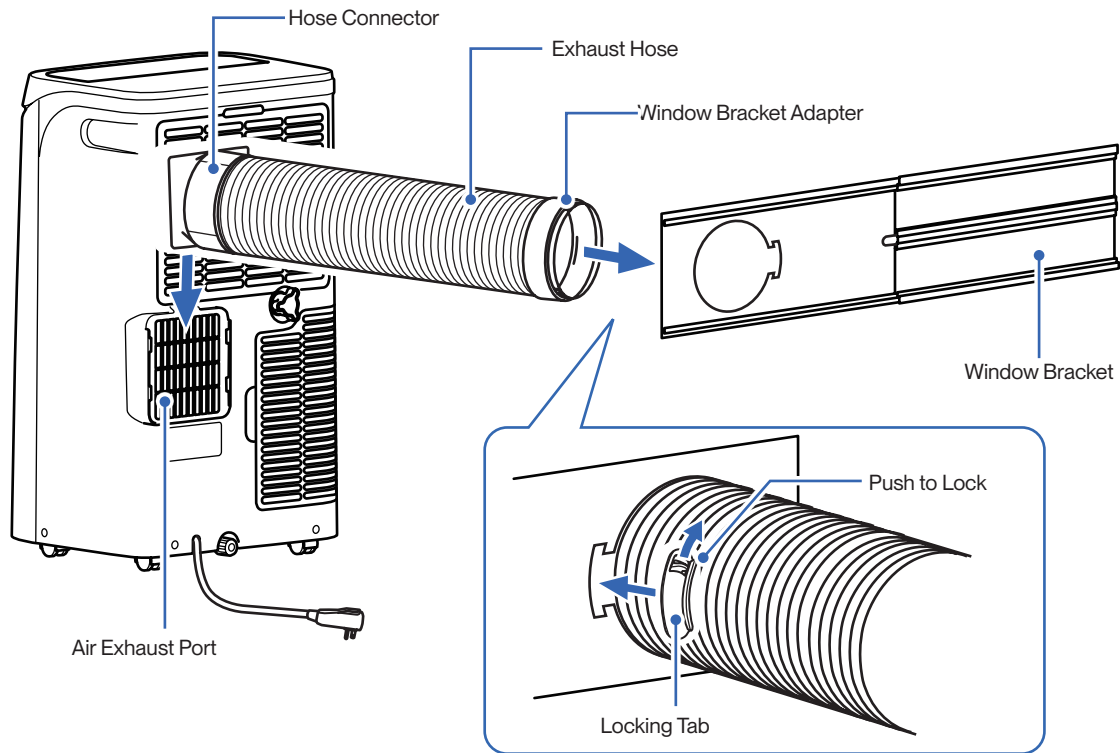

Attaching Foam Seal

1. Attach foam seal to the window sash and the window frame

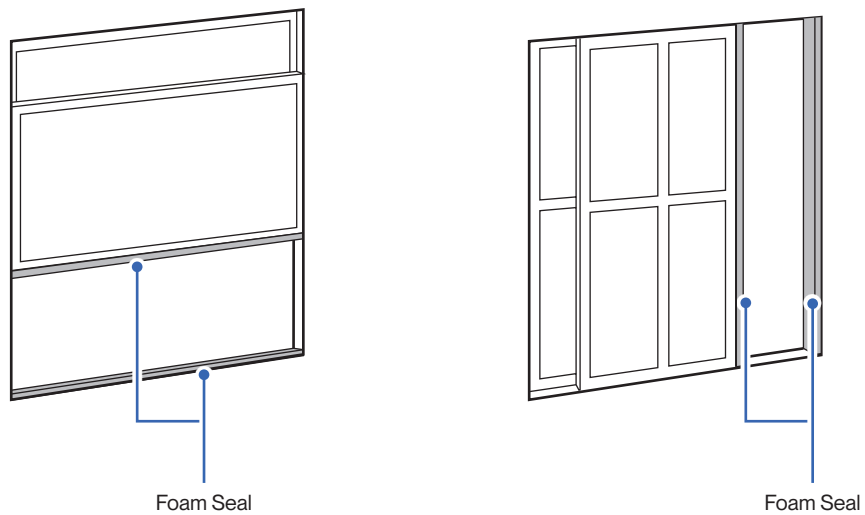

Installation

Attach Window Bracket to Window

1. Place the window bracket between the window sash and window frame, and then close the window.

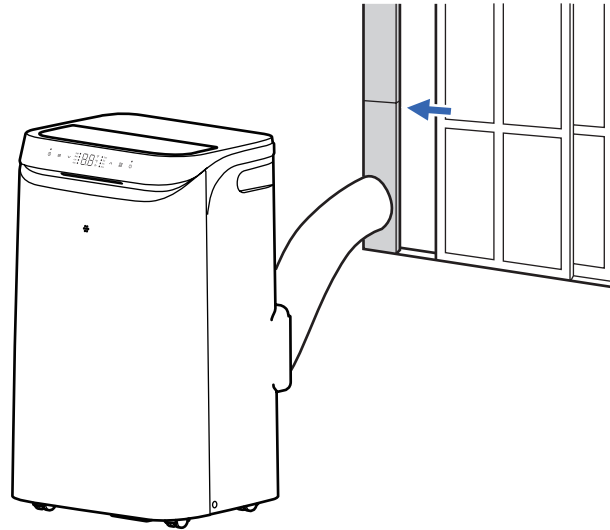
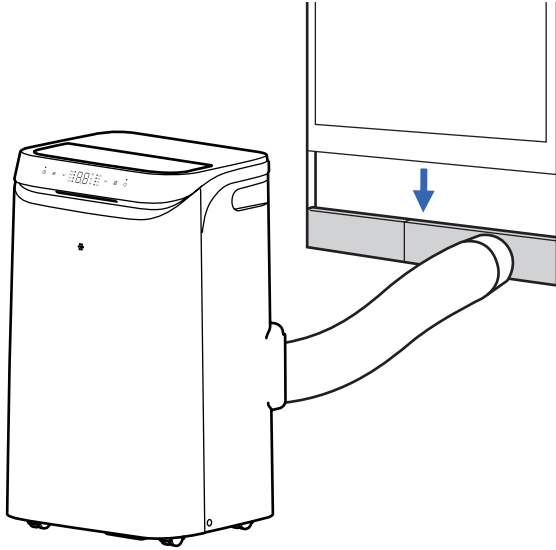

- The exhaust hose should be kept a minimum length and as straight as possible.
- Stretching or bending the hose excessively will decrease cooling efficiency.

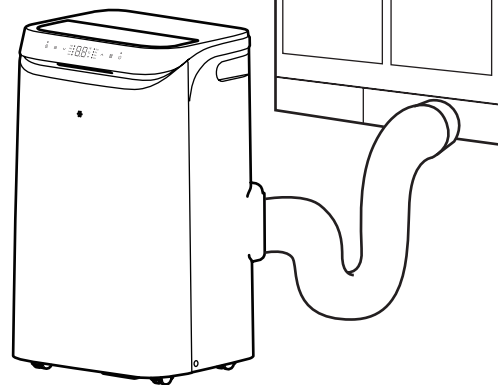
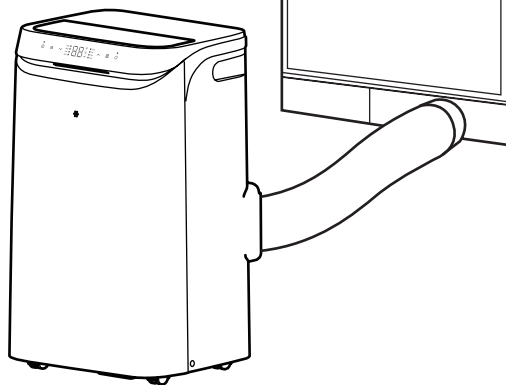

Installation

Secure Window Sash (Optional)

- 1. Attach window sash locks on top of the sash and push against the window bracket .



Installation

Power Connection

1. Insert the power plug into a wall power socket.



WARNING

- The AC should only be plugged into a 3 prong wall outlet. If a 3 prong is not available, it is the customer's responsibility to have a grounded 3 prong outlet properly installed by a qualified electrician.
- Do not use a power strip or extension cord to minimize the possibility of electrical shocks, sparks, or fire.

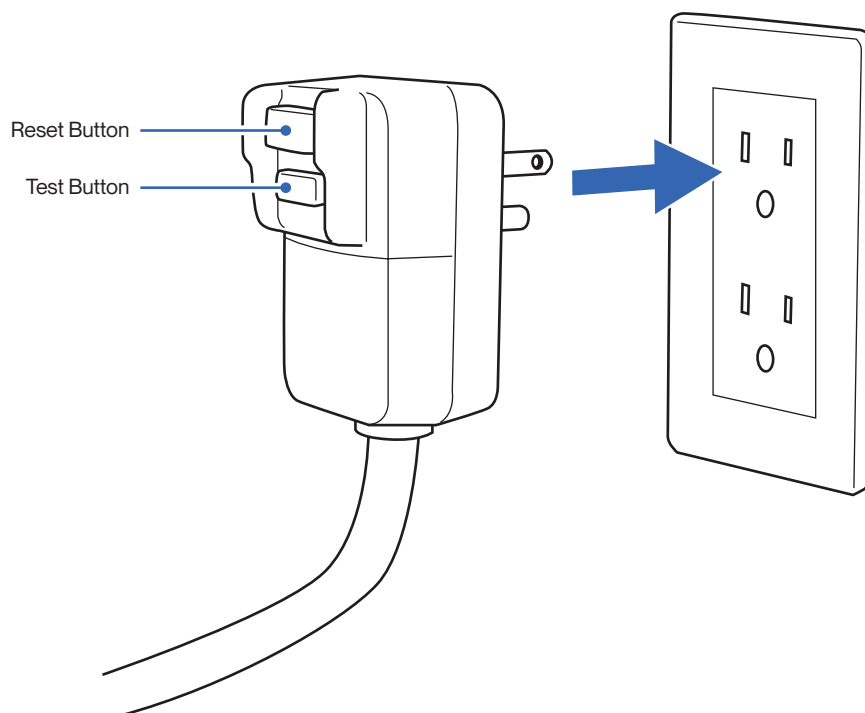

Power Plug Testing

This appliance is equipped with a Leakage Current Detection Interrupter (LCDI) plug. LCDI plug will disconnect the unit from power if it senses leakage current.

Test the LCDI plug to check if the plug is functioning properly.

1. Insert the plug into a grounded 3 prong power outlet.
2. Press the RESET button.
3. Press the TEST button. If the plug is functioning properly, the circuit should tripped, cutting power and the appliance should not work.
4. Press the RESET button again, you will hear a click and the appliance should work again without any problem.



WARNING

- Do not operate the appliance with a defective LCDI plug.

Before Using

Operation Tips

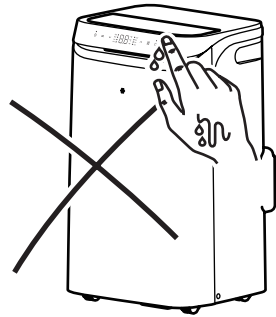

Avoid operating the air conditioner with wet hand.

- It may cause electric shock.

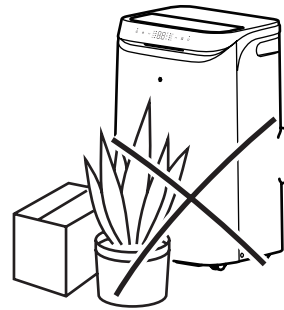

Avoid putting plants or objects around the air conditioner.

- It may block air flow and lower the air conditioner efficiency or cause malfunction.

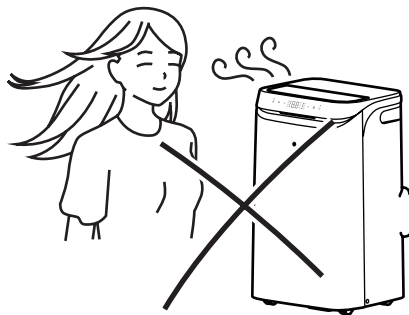

Avoid direct wind flow to people, pets, or plants.

- Expose to direct wind flow for extended period of time may have a negative impact on your health.

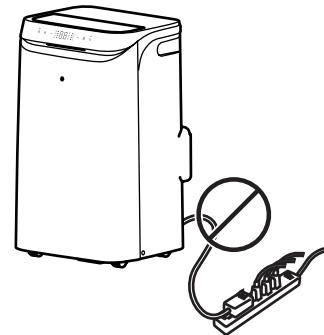

DO NOT plug the air conditioner to a power strip.

- It may leads to power strip overload and overheat, potentially cause electric shock and fire.

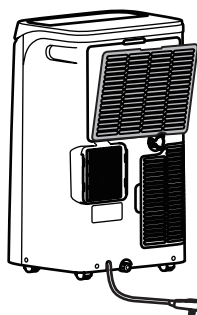

Follow cleaning and maintenance routine.

- Regular cleaning and maintenance are needed for the best efficiency and prevent bad odor or water leak.

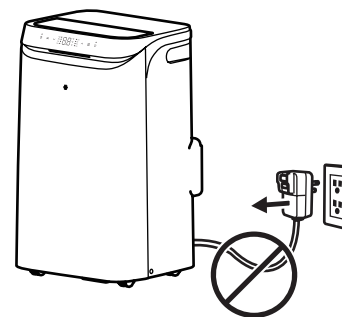

DO NOT disconnect the air conditioner from power socket before shutting down.

- It may cause electric spark and fire.

Before Using
Before Using

Before Using

Control Panel



Icon	Function
	Power Button Power ON / OFF the air conditioner Page 21
	Mode Button Select operation mode Page 21
	Fan Button Select fan speed Page 21
	Timer Button Enable ON / OFF timer setting Page 22
	Increase / Decrease Button Adjust temperature / timer setting value Page 21
	Wi-Fi Icon Show Wi-Fi function status

Before Using

Remote Control (Insert Battery)

1. Slide and remove the battery tray from the remote control.
2. Place a CR2025 coin battery into the battery compartment.
3. Reinstall the battery tray into the remote control.

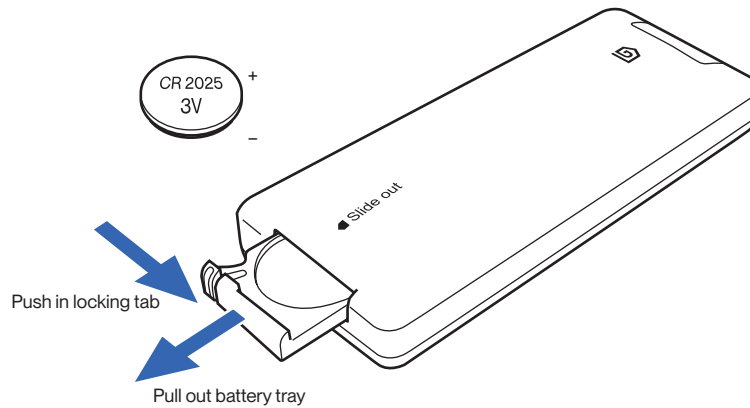

Before Using
Before Using

Remote Control

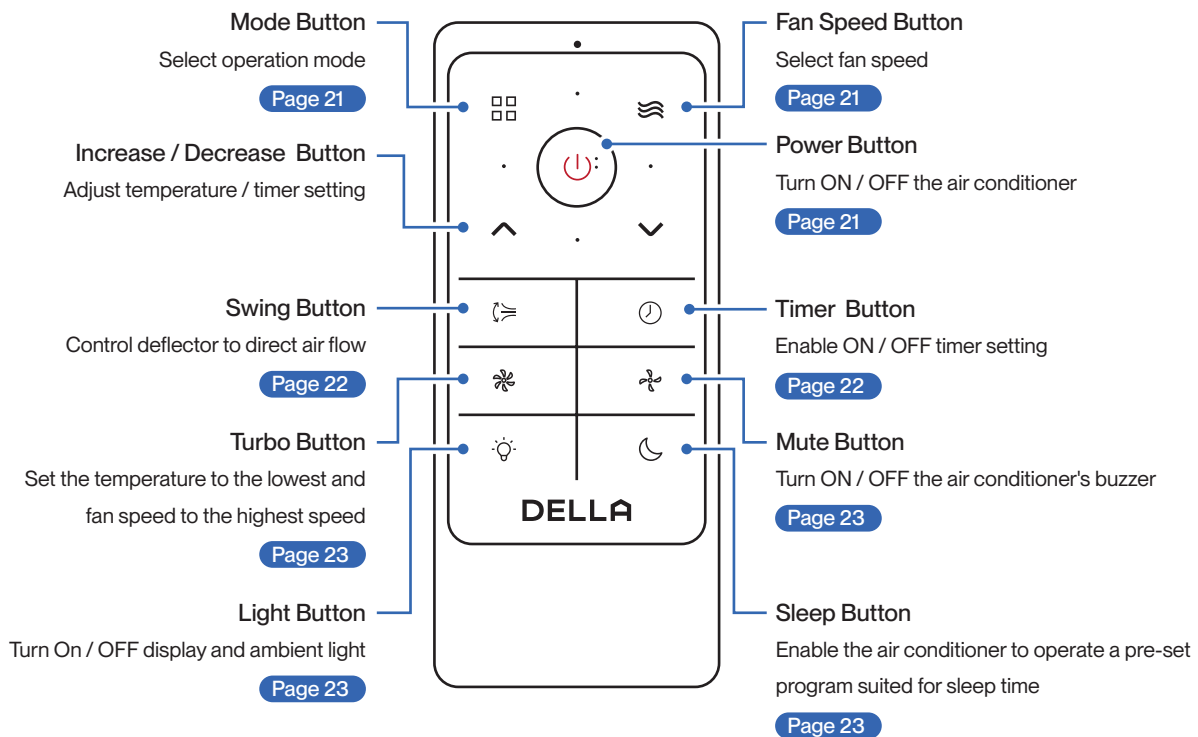

Remote Control

Coin Cell Battery Safety Warning

⚠ WARNING

- **INGESTION HAZARD:** This product contains a button cell or coin battery.
- **DEATH** or serious injury can occur if ingested.
- A swallowed button cell or coin battery can cause **Internal Chemical Burns** in as little as **2 hours**.
- **KEEP** new and used batteries **OUT OF REACH** of **CHILDREN**
- **Seek immediate medical attention** if a battery is suspected to be swallowed or inserted inside any part of the body.



- a) Remove and immediately recycle or dispose of used batteries according to local regulations and keep away from children. Do NOT dispose of batteries in household trash or incinerate.
- b) Even used batteries may cause severe injury or death.
- c) Call a local poison control center for treatment information.
- d) Compatible battery type: CR2025, Voltage: 3V.
- e) Non-rechargeable batteries are not to be recharged.
- f) Do not force discharge, recharge, disassemble, heat above manufacturer's specified temperature rating or incinerate. Doing so may result in injury due to venting, leakage or explosion resulting in chemical burns.
- g) Ensure the batteries are installed correctly according to polarity (+ and -).
- h) Do not mix old and new batteries, different brands, or types of batteries, such as alkaline, carbon-zinc, or rechargeable batteries.
- i) Remove and immediately recycle or dispose of batteries from equipment not used for an extended period of time according to local regulations.
- j) Always completely secure the battery compartment. If the battery compartment does not close securely stop using the product, remove the batteries, and keep them away from children.
- k) Do not ingest battery, Chemical Burn Hazard.
- l) This product contains a coin or button cell battery. If the coin or button cell battery is swallowed, it can cause severe internal burns in just 2 hours and can lead to death.
- m) Keep new and used batteries away from children. If the battery does not close securely, stop using the product and keep it away from children. If you think batteries might have been swallowed or placed inside any part of the body, seek immediate medical attention.

Basic Operation

Power ON / OFF

Press  on the control panel or the remote control.

- The air conditioner will start operating in the same mode as the last time before shutting down.



Select Operation Mode

Press  on the control panel or remote control to select operation mode.



- Cool Mode: The air conditioner will cool the room according to your set temperature.
- Dry Mode: The air conditioner will reduce the humidity in your room.
- Fan Mode: The air conditioner will circulate air in the room.
- Auto Mode: The air conditioner will automatically operate in cool mode when room temperature is above 77°F / 25°C or fan mode when room temperature is below 73°F / 23°C.

Adjust Temperature

Press   on the control panel or remote control to adjust temperature setting when operating in cool mode.

- Temperature setting will adjust by 1°F / 1°C increment for each time the button is pressed.
- Temperature can only be set between 61°F - 86°F / 16°C - 30°C.

Adjust Humidity Target

Press   on the control panel or remote control to adjust humidity target setting when operating in dry mode.

- Humidity target can be set between 30% - 70%.

Set Fan Speed

Press  on the control panel or remote control to select your desired fan speed.





Basic Operation

Swing Function

On the control panel, press and hold  for 3 seconds.



On the remote control, press .



- The horizontal deflector will oscillate up and down.

To stop the deflector, press and hold  for 3 seconds on the control panel, or press  on the remote control again.



Timer Function (Shutdown Timer)

Set a timer to automatically turn OFF the air conditioner.

Press  on the control panel or  on the remote control when the air conditioner is ON.

Press   to set the desired turn off time. Timer can be set between 0.5 - 24 hours.

Leave the setting for 5 seconds, and the air conditioner will start the timer automatically.



Set the timer to 00 or press  on the control panel or  on the remote control again to cancel the timer setting.

Timer Function (Start-up Timer)

Turn ON the air conditioner, then choose your desired operation mode, fan speed, and temperature setting.

Turn OFF the air conditioner.

Press  on the control panel or  on the remote control when the air conditioner is OFF.

Press   to set the desired turn off time. Timer can be set between 0.5 - 24 hours.

Leave the setting for 5 seconds, and the air conditioner will start the timer automatically.

Set the timer to 00 or press  on the control panel or  on the remote control again to cancel the timer setting.

Advance Function

Sleep Mode

In sleep mode, the air conditioner will operate a pre-set program which is suitable during sleep.

Press  on the remote control to enable sleep mode.

- This display will turn off after 1 minute.
When operating the air conditioner during sleep mode, the display will light up to 30% brightness for 1 minute.
- Cool Mode: The air conditioner will automatically set the fan speed to low. The temperature will increase by 1°F after 1st hour and then another 1°F after the 2nd hour.
- Dry Mode: The air conditioner will automatically set the fan speed to low. Humidity target will increase by 5% per hour until 10% increase is reached.
- Auto Mode: The air conditioner will automatically operate the same way as cool mode or dry mode. If the operating mode changes from cool mode to dry mode, the temperature will automatically reset to the initial set value and sleep function timer will restart.
- Sleep mode is not available in fan mode.

To disable sleep mode, press  again on the remote control.

Changing operation mode, fan speed, using turbo mode, or turning off the air conditioner will also automatically disable sleep mode.

Turbo Mode



Press  on the remote control enable turbo mode.

Alternatively, set the temperature to the lowest and fan speed to the highest on the control panel to enable turbo mode.

- Turbo mode is only available in cool mode.

Display and LED Light ON / OFF

Press and hold  for 3 seconds on the control panel or press  on the remote control to turn off the display screen and LED light.

Press and hold  for 3 seconds on the control panel or press  on the remote control again to turn on the display and LED light



Buzzer ON / OFF

Press  on the remote control to turn off the buzzer sound.

Press  on the remote control again to turn on the buzzer sound.

Advance Function

°F / °C

Press and hold  and  simultaneously for 3 seconds on the control panel to change the temperature unit on the display.

- The temperature unit will switch between °F and °C.

Wi-Fi Reset

Press and hold  for 3 seconds on the control panel to reset and ready for pairing with your air conditioner to the "Della+" app.

Child Lock

Press and hold  and  simultaneously for 3 seconds on the control panel to enable child lock.



- When child lock is enabled, all other buttons will not function when pressed.



Press and hold  and  simultaneously for 3 seconds on the control panel again to disable child lock.

NOTE: Child lock function is only accessible on the control panel and is not on the remote control.

Clean Filter Reminder

Clean filter reminder will activate after the air conditioner operate for 600 hours.

-  will flashes follow by  on the display for 10 seconds, then the display will display temperature setting.
-  will flashes for 10 seconds every time the air conditioner is turned on until reminder timer is reset.

To reset reminder, press and hold  and  simultaneously for 3 seconds on the control panel. The air conditioner make a buzzing sound to confirm the reset.

Alternatively, the reminder will automatically reset after the air conditioner has operated for 24 hours from the time the reminder was activated.

Reset AC to Default Setting

Press and hold  for 5 seconds on the control panel to reset the air conditioner to factory default.

Advance Function

Wi-Fi Set up

To set up the DELLA+ app to control your AC.

1. Search "DELLA+" on Apple app store or Google Play, or scan the QR code below to download the application.
2. Register an account in the app.
3. Follow the in app instructions to add and pair your Della AC to the app and complete the Wi-Fi set up. You can also scan the device QR code in the DELLA+ app for a quick device search.

DELLA+ App Download



You can also scan the download QR code

Device QR code



Scan this QR code in your Della+ app to quickly add device.

Household Set up (Optional)

Create and Join home to control your Della AC via the Della+ app from multiple devices and multiple accounts.

1. Click "Me" on the Della+ app.
2. Choose "Home Management".
3. Follow the in app instructions to create or join a home.

NOTE: Pairing your Della AC with a different account outside the household will remove the original pairing. Only one household can be paired at a time.

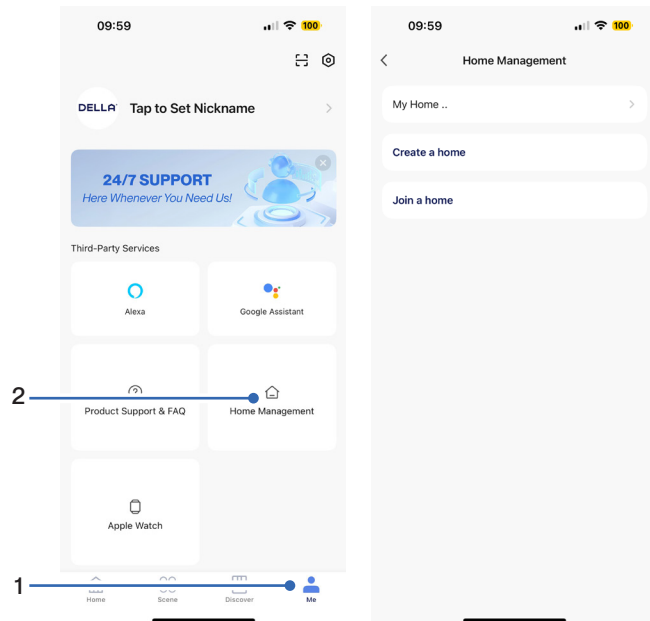

!

- The Della+ application is free, however, data charges may apply when downloading or using the application.
- Della+ can be altered without notice for quality improvement and also be deleted depending on the circumstances of manufacturing firms.
- All trademarks, logo, brand names are the property of their respective companies. Use of these names, brands, and trademarks does not imply endorsement. Della assumes no responsibility with regard to the performance or use of these products.

QUICK TIPS

Check out detailed tutorial on the most updated application on dellahome.com/support.

Care and Maintenance

Water Drainage

Water drainage using the Bottom Drain Outlet

When the internal water tank is full, the digital display will show "HL" error code, and water need to be drained.

1. Carefully move the air conditioner to a drain location, then open the bottom drain plug and drain the water.
2. After draining, turn the drain plug back into the drain outlet and restart the air conditioner.

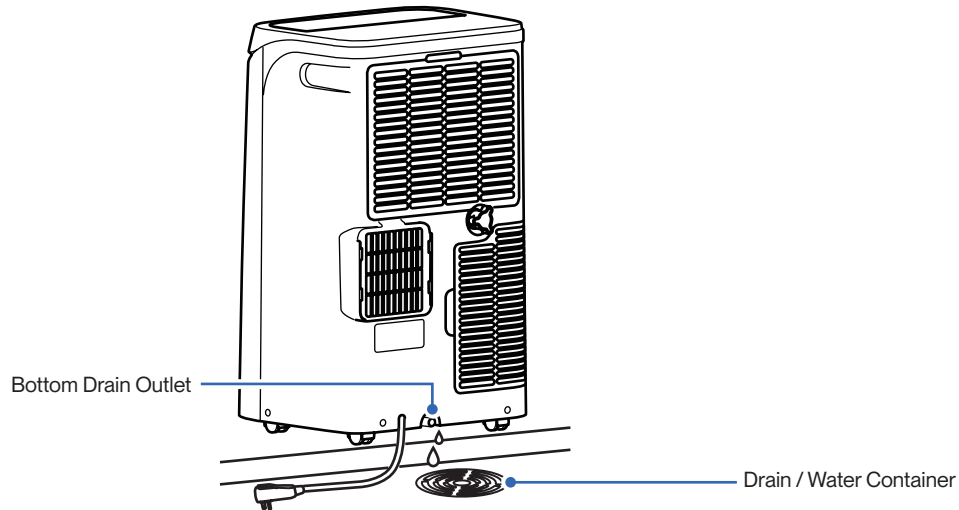

Water drainage using the Upper Drain Outlet

Upper drain outlet allow continuous water drainage. It is only recommended if the air conditioner operate in dehumidify mode for extended period of time. Avoid attach the drain hose to the upper drain outlet permanently, it might reduce the air conditioner performance.

1. Remove the cover on the upper drain outlet and insert the drain hose to the it.
2. Place the other end of the hose to a drain area.

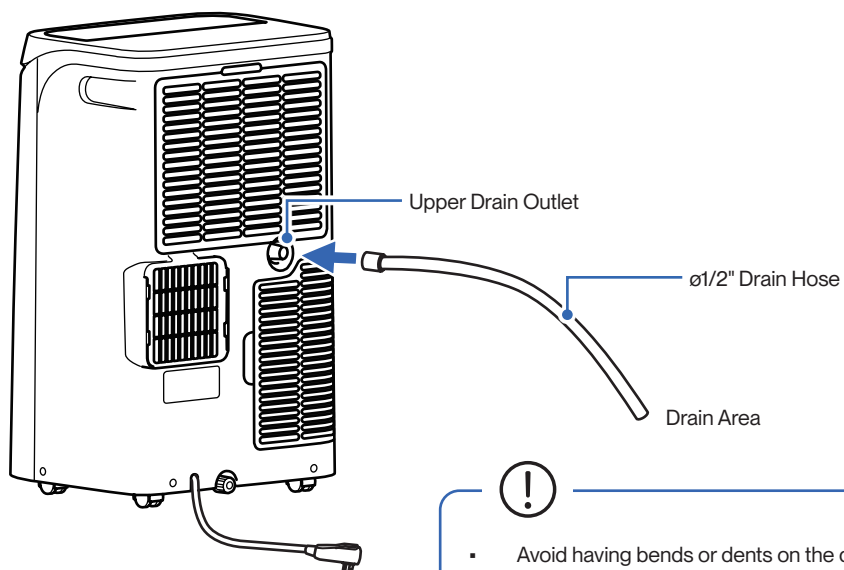

- Avoid having bends or dents on the drain hose.
- Do not leave the end of the hose into water to prevent air lock.

Care and Maintenance



- Before cleaning the unit, you must shut down the machine and cut off the power supply for at least 5 minutes.
- Never flush the air conditioner with water.

Clean the Unit

1. Clean the air conditioner with a soft dry cloth or a dampened cloth with neutral detergent.
2. Remove any possible debris on the vents and air outlet.



Clean the Air Filter

1. Remove the air filter from the air conditioner.
2. Clean the air filter using a vacuum cleaner or with soapy water.
3. Air dry the air filter.
4. Put the air filter back to its original position after it is dry.

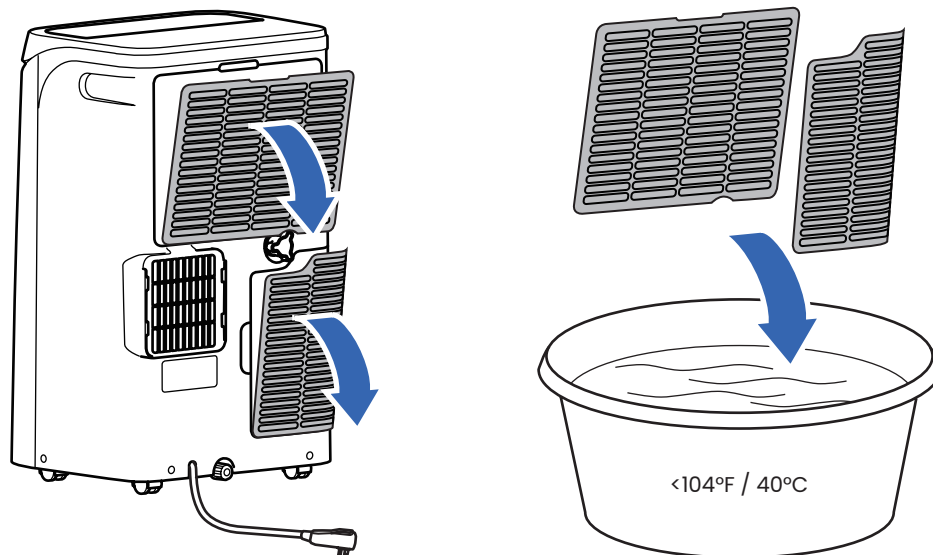

- Check and clean the air filter regularly to prevent dust accumulation.
- Clean the air filter frequently if the operating environment is dusty or has bad air quality.

Care and Maintenance

Maintenance Routine

- Clean the air filter screen every month.
- Regularly check and remove any obstacles from the air vent.

Planning to Not Operate the Air Conditioner for a Long Period (e.g. Winter Season)

- Take out the batteries from the remote control and disconnect the power supply of the air conditioner.
- Detach exhaust hose and window sealing board from the air conditioner.
- Drain all the remaining water from the air conditioner to prevent mold or bacteria growth.
- Clean the air filter.
- Store the air conditioner in a dry indoor location. The unit must be kept in an upright position.

Using the Air Conditioner After a Long Idle Period

- Clean the unit and the air filter screen.
- Remove any obstacles at the air inlet and outlet.
- Install batteries into the remote control and reinstall the air conditioner in your desired location.

Troubleshooting

Before consulting repair or warranty, please check the following troubleshooting guide.

In the case of an persistent problem, contact a qualified technician for diagnosis and repair.



WARNING

- When encountering persisting problem, stop operation and turn off the breaker. Continue operation in an abnormal condition may cause electric shock, fire, or damage to the unit.
- Do not attempt to repair or modify the unit by yourself. Incorrect work may result in electric shock, fire or injury.

Problem	Possible Cause / Explanation / Solution
The air conditioner is non operational	The power cord is not plugged to a electric outlet.
	The house's circuit breaker box tripped. Check and reset the breaker.
	When pressing the power button soon after power failure - The internal protection is activated, wait for a few minutes for the AC to resume normal operation.
	The LCDI plug tripped. Reset the power plug.
	Faulty electric connection, mismatch outlet voltage, or damaged electronic control board. Contact a qualified technician.
	Water tank is filled. Drain the water.
The air conditioner does not cool	Restricted airflow. Try clearing any obstacles blocking the air outlet.
	Check and make sure the temperature setting is below the room temperature.
	Air filter is too dirty. Clean the air filter.
	Cold air is leaking out from the room. Close windows to prevent cold air leaking out.
	Other heat source in the room. Remove heat source.
	Exhaust hose is loose, bent, or obstructed. Check the exhaust hose and window kit and make sure installation guidance is followed.

Having Problems?
Having Problems?

Troubleshooting

Problem	Possible Cause / Explanation / Solution
Strange odor from the air flow	Air filter is too dirty. Clean the air filter.
	The smells of the room, furniture, or cigarettes are absorbed into the unit and then discharged. Remove odorous objects from the room.
Water Leak	Water tank is full. Drain the water.
Noise or Vibration	The air conditioner is placed on uneven ground. Put it on a flat surface.
The air conditioner does not respond to the remote control commands	Remote Control is too far away from the air conditioner.
	There is an obstruction between the remote control and the air conditioner..
	The battery power has run out in the remote control. Replace the battery.

Error Code

Error Code	Description
E0	Communication fault between main PCB and display panel
E1	Indoor temperature and humidity sensor fault
E2	Coil temperature sensor failure
F1 / HL	Full water tank



WARNING

Switch off the air conditioner immediately and cut off the power supply in the event of:

- Strange, loud noises during operation.
- Faulty electronic control board.
- Faulty fuses or switches.
- Spraying water or objects inside the appliance.
- Frequent circuit breaker tripped during operation.
- Abnormally hot or damaged power cord or plug.
- Very strong smells discharging from the appliance.

Disposal Guideline

This appliance contains refrigerant and other potentially hazardous materials. When disposing of the appliance, follow all federal, state, and local regulations. DO NOT dispose of this product as normal household waste or unsorted municipal waste.

When disposing of this appliance, you have the following options:

- Dispose of the appliance at a designated municipal electronic waste collection facility.
- When buying a new appliance, the retailer will take the old appliance.
- The manufacturer may take back the old appliance.
- Sell the appliance to a certified scrap metal dealer.

Having Problems?
Having Problems?

Warranty



Scan the QR code or visit our page on dellahome.com/pages/warranty to sign up for warranty coverage on your new DELLA appliance.



dellahome.com/pages/warranty

Compliance Information

Radio Frequency Interference



Model: 048-DPAC-8 / 048-DPAC-10

FCC ID: 2ANDL-WBR3

FCC Caution

This device complies with part 15 of the FCC Rules. Operation is subject to the following two conditions:

(1) This device may not cause harmful interference, and (2) this device must accept any interference received, including interference that may cause undesired operation. Any changes or modifications not expressly approved by the party responsible for compliance could void the user's authority to operate the equipment.

NOTE: This equipment has been tested and found to comply with the limits for a Class B digital device, pursuant to Part 15 of the FCC Rules.

These limits are designed to provide reasonable protection against harmful interference in a residential installation. This equipment generates, uses and can radiate radio frequency energy and if not installed and used in accordance with the instructions, may cause harmful interference to radio communications. However, there is no guarantee that interference will not occur in a particular installation. If this equipment does cause harmful interference to radio or television reception, which can be determined by turning the equipment off and on, the user is encouraged to try to correct the interference by one or more of the following measures:

- Reorient or relocate the receiving antenna.
- Increase the separation between the equipment and receiver.
- Connect the equipment into an outlet on a circuit different from that to which the receiver is connected.
- Consult the dealer or an experienced radio / TV technician for help.

Memo



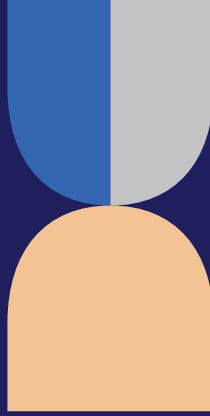

 www.dellahome.com

 support@dellahome.com

 800-863-4143

 6:00 a.m. – 4:00 p.m. PST Monday – Friday

© Della All rights reserved.

The design and specifications are subject to change without prior notice for product improvement. Any updates to the manual will be uploaded to the della website.
