

## Stainless Steel Pump

to dispense portions up to 2oz

### MODELS INCLUDE:

CP-1/3 2oz

CP-8½ 2oz

CP-10½ 2oz

CP-15L 2oz

CP-F 2oz

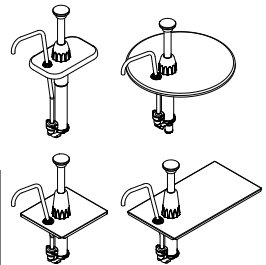
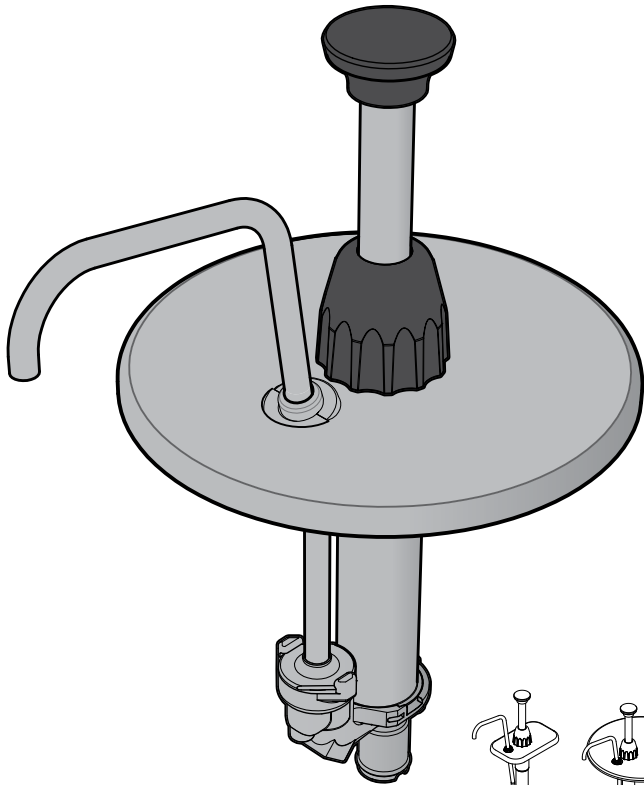

## Thank You

for purchasing our Stainless Steel Pump.  
This quality, NSF listed pump delivers larger portions with  
less effort and lasts for years of service.

CONSISTENT PORTIONS—SERVE BETTER

*Your pump may vary  
depending on specific  
model number.*

# PUMP PARTS

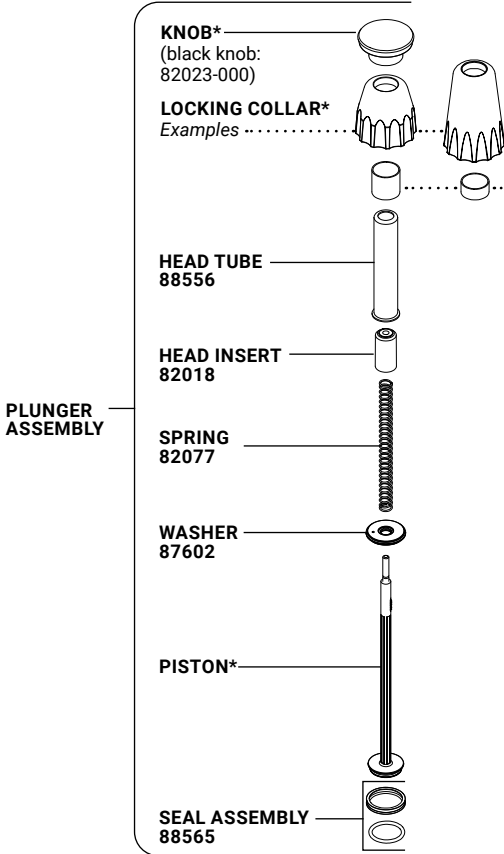

## PORTION CONTROL

PUMP DELIVERS 2 FL OZ PORTIONS

To reduce portion, add **GAGING COLLAR(S)\***

Examples

- 88571 SM COLLAR:** 1/4 fl oz reduction
- 88568 LG COLLAR:** 1/2 fl oz reduction

### COLLAR(S) USED    PORTION RESULT

None	2 fl oz
1 Sm	1-3/4 fl oz
1 Lg	1-1/2 fl oz
1 Lg + 1 Sm	1-1/4 fl oz

**FOOD EQUIPMENT LUBRICANT**  
40179

**BRUSH**  
82049

**BRUSH\***  
82526

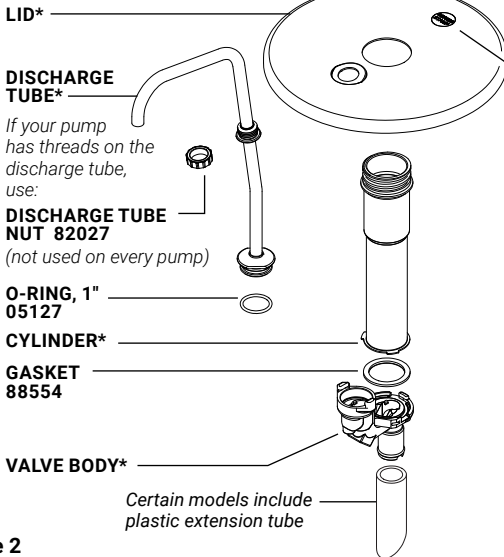

## MODEL NUMBER

**\*Parts may vary depending on specific model.**

Pump model, P/N (part number) and other identification are stamped on lid:

MODEL    SERIES  
XXXX    ##X ##X  
P/N    NSF  
#####

For additional details about your pump, visit [www.Server-Products.com](http://www.Server-Products.com)

Enter your P/N into the search bar.



# SAFETY



According to food and safety regulations, most foods must be stored and/or served at certain temperatures or they could become hazardous. Check with local food and safety regulators for specific guidelines.

Be aware of the product you are serving and the temperature the product is required to maintain. Server Products, Inc. cannot be responsible for the serving of potentially hazardous product.

## IMPORTANT

Clean, rinse, sanitize, and dry parts daily or regularly to comply with local sanitization requirements.



NSF International list this pump as  
"Not acceptable for dispensing potentially hazardous foods."

# PUMP CLEANING

## 1 FLUSH & RINSE

all pump surfaces with hot water.  
Place lower end of pump into container of hot water and operate pump until all remaining product is expelled and only hot water is discharged.

## 2 DISASSEMBLE & CLEAN

all washable parts with soap and hot water.  
(See DISASSEMBLY on page 5.)

### USE SUPPLIED BRUSH

to thoroughly clean inside discharge tube and any confined areas.

## 3 RINSE

fully with clean water.

## 4 SANITIZE

all parts according to local sanitization requirements. All parts in contact with food must be sanitized.

## 5 AIR DRY

all parts fully.

**YES!**

Use dishwashing soap, hot water and nylon brush.

*Pump is dishwasher safe.*

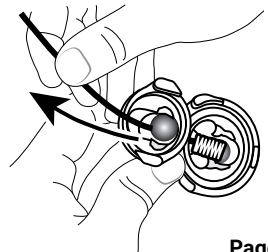
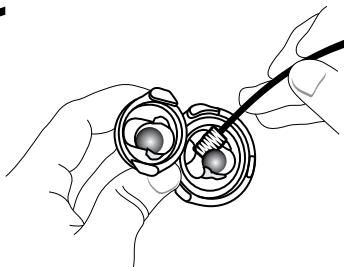
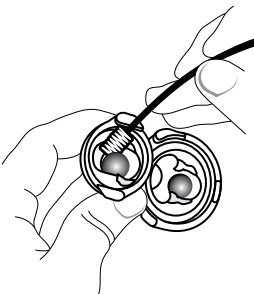
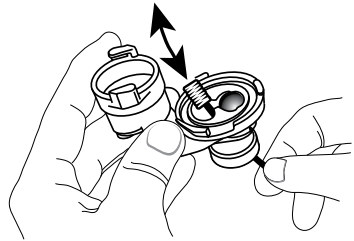
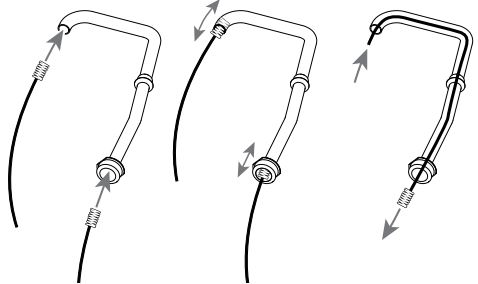

# CLEAN-IN-PLACE PROCEDURE FOR PUMPS

## 1 CLEAN

- Pump out all (if any) remaining food product from inside pump body.
- Wash and rinse off outside of pump body.
- Flush out and rinse inside of pump.
- Place lower end of pump into container full of water and operate pump until all (if any) remaining product is expelled and only warm water flows from discharge tube.
- Mix 2 tsp (10 mL) of dishwashing detergent with 2 quarts (1.9 L) of hot tap water (approximately 110°F /43°C).
- Place lower end of pump into cleaning mixture. Pump until all cleaning mixture is expelled.

## 2 RINSE

- Place lower end of pump into 4 cups (1 L) of hot tap water (approximately 110°F /43°C) and pump until all tap water is expelled.

## 3 SANITIZE

- Mix one 1 oz (30 mL) packet of KAY-5 Sanitizer/Cleaner (EPA REG No. 5389-15) with 2.5 gallons (9.5 L) of tap water (approximately room temperature).
- Place lower end of pump into this sanitizing mixture and repeatedly operate pump until 2 quarts (1.9 L) sanitizing mixture is pumped through pump.

## 4 RINSE

- Place lower end of pump into 2 cups (.5 L) of hot tap water (approximately 110°F /43°C) and pump until all tap water is expelled.

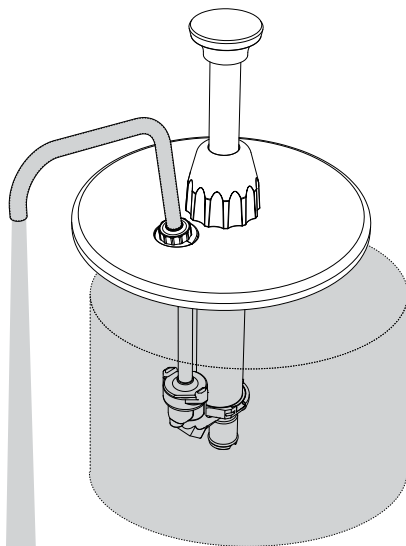

# CARE OF STAINLESS STEEL

## This durable pump includes stainless steel components.

If you notice corrosion beginning on any stainless steel surface, you may need to change the cleansing agent, sanitizing agent, or the cleaning procedures you are using.

- A mildly abrasive nylon or brass brush may be used to remove any stubborn deposits.

- Fully rinsing and drying all parts can help prevent corrosion. Elements and minerals in tap water can accumulate on stainless steel parts and create corrosion.
- Do not use abrasive, caustic or ammonia based cleansers.
- Do not use products containing acids, alkalines, chlorine, or salt. These agents can corrode stainless steel.
- Do not use metal scrapers or cleaning pads that could scratch surfaces.

# DISASSEMBLY

If pump has been in use, first rinse and flush pump. See PUMP CLEANING on page 3.

During disassembly, collect small parts in a container to prevent loss.

**1 REMOVE PLUNGER & LID**  
Turn locking collar  
(and discharge tube nut if used)  
counterclockwise to loosen and remove.

**2 REMOVE CYLINDER &  
DISCHARGE TUBE**  
Twist each counterclockwise to  
release from slots in valve body.

**3 REMOVE GASKET  
& O-RING**  
from the valve body and  
bottom of discharge tube.  
*Do not use a sharp tool.*

**4 DISASSEMBLE PLUNGER:**

**REMOVE KNOB**  
Prevent knob from springing off:  
Press head tube towards piston base  
while twisting knob off.

**REMOVE LOCKING COLLAR**

**REMOVE GAGING COLLAR(S)**  
(if used).

**REMOVE HEAD INSERT**  
from inside head tube.

**REMOVE SPRING & WASHER**  
from piston.

**REMOVE SEAL ASSEMBLY**  
from piston.  
Pry off.  
*Do not use a sharp tool.*

**REMOVE O-RING**  
from inside seal.

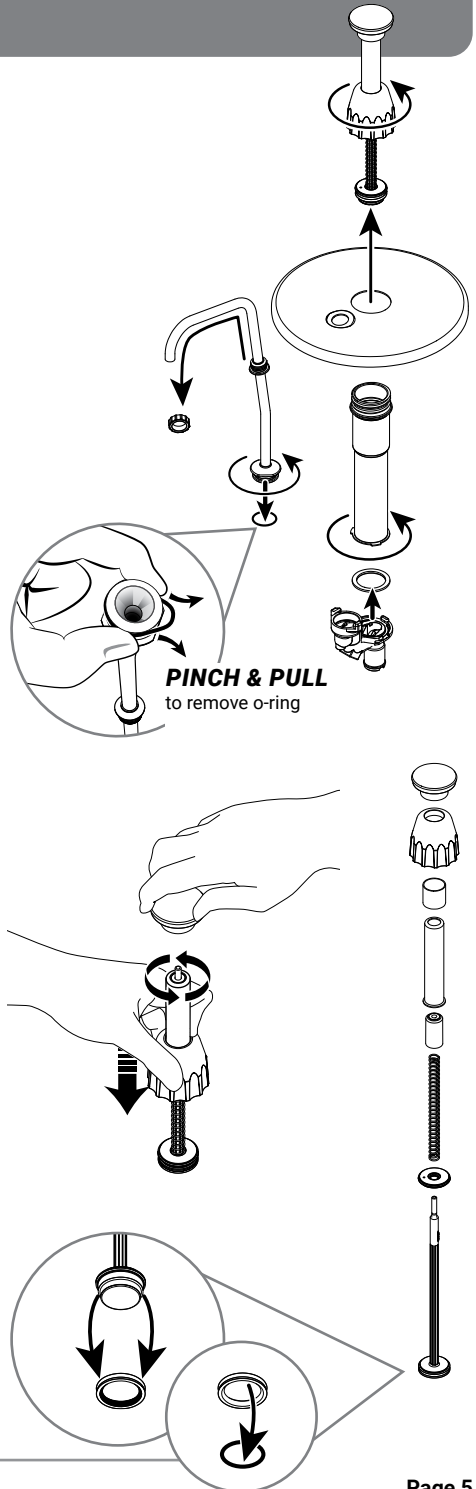

# ASSEMBLY



WASH ALL PARTS PROPERLY BEFORE EVERY USE. See page 3.

## 1 PREPARE PISTON

- A** INSTALL SMALL O-RING onto seal.
- B** INSTALL SEAL onto piston head. Apply food equipment lubricant to outside of seal.
- C** SLIDE WASHER onto piston.
- D** SLIDE SPRING onto piston

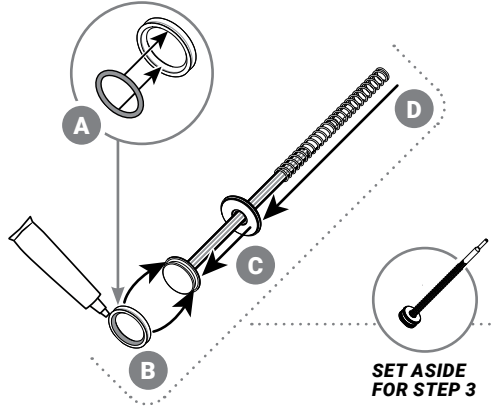

## 2 PREPARE HEAD TUBE

- A** *OPTIONAL:* ADD GAGING COLLAR(S) Slide collar(s) onto head tube to reduce portion size. See page 2 for PORTION CONTROL.
- B** SLIDE LOCKING COLLAR (wide side down) towards flared end of head tube.
- C** SLIDE HEAD INSERT (beveled edge first) into head tube.  
**TIP:** The end with smaller hole should go in first.

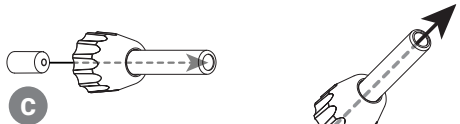
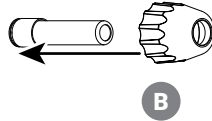
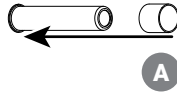

## 3 INSERT PISTON ASSEMBLY into head tube assembly.

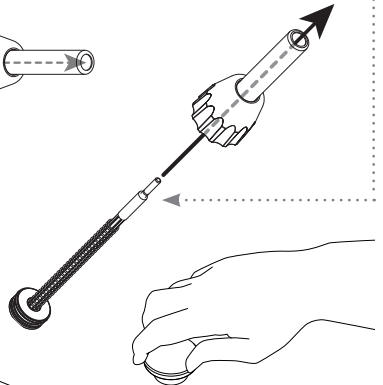

- 4** INSTALL KNOB Press head tube down to compress spring and expose piston threads. Rotate knob clockwise to secure.

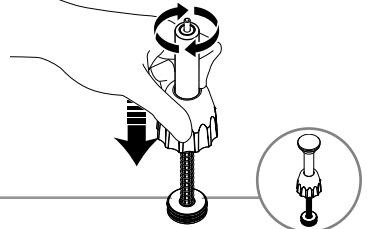

- 5** INSTALL GASKET into valve body. Apply food equipment lubricant on gasket.



**TIP:** Flat side of gasket should face up.

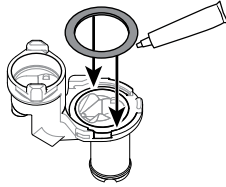

- 6** INSTALL CYLINDER onto valve body.

**TILT** edge of cylinder under nub on rim of valve body.

**FIT TABS** on cylinder into corresponding notches in valve body.

**PRESS DOWN** firmly and **ROTATE** cylinder clockwise to secure into slots.

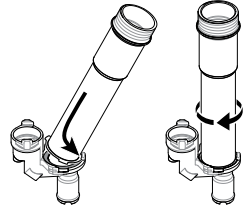
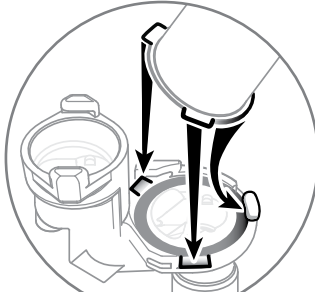

- 7** INSTALL O-RING onto discharge tube. Apply food equipment lubricant on o-ring.

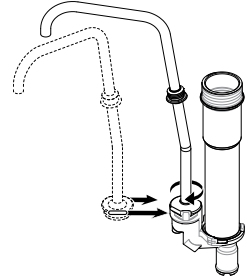
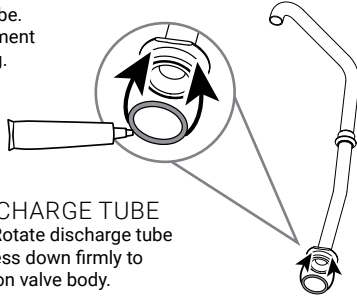

- 8** INSTALL DISCHARGE TUBE onto valve body. Rotate discharge tube clockwise and press down firmly to secure into slots on valve body.

- 9** INSTALL LID by sliding smaller lid hole over discharge tube. Align center hole with threads on cylinder.

**IF DISCHARGE TUBE HAS THREADS:**

To secure lid, slide discharge tube nut onto discharge tube. Rotate nut clockwise to secure.

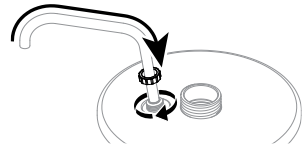
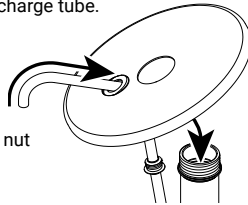

- 10** INSTALL PLUNGER ASSEMBLY into cylinder. Rotate locking collar clockwise onto cylinder threads to secure.

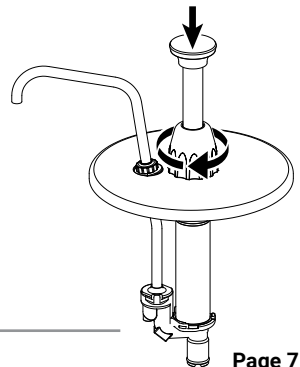

# TROUBLESHOOTING

## PROBLEMS WITH FLOW OR PORTIONS?

- Clean pump.
- **Food product** may be too thick or contain a solid that will not pass through pump.
- If used: Ensure **gaging collar(s)** are undamaged and properly installed on head tube.

## PLUNGER DOESN'T RETURN TO TOP AFTER DISPENSING?

- Ensure that the **spring** is functional. Replace broken spring if necessary.
- Ensure that the **washer** is installed between the spring and piston head.

## FOOD PRODUCT OZES OUT AROUND LOCKING COLLAR?

- Ensure **seal** is properly installed on piston.

## LEAKS NEAR THE VALVE BODY?

- Ensure **gasket** is properly installed. Flat side of gasket should face up.

## PUMP DRIPS?

- Clean **discharge tube** with supplied brush.
  - Inspect all **o-rings**. Replace if damaged.
  - **Food product** may be too thin.
- Visit [www.Server-Products.com](http://www.Server-Products.com) for more tips.

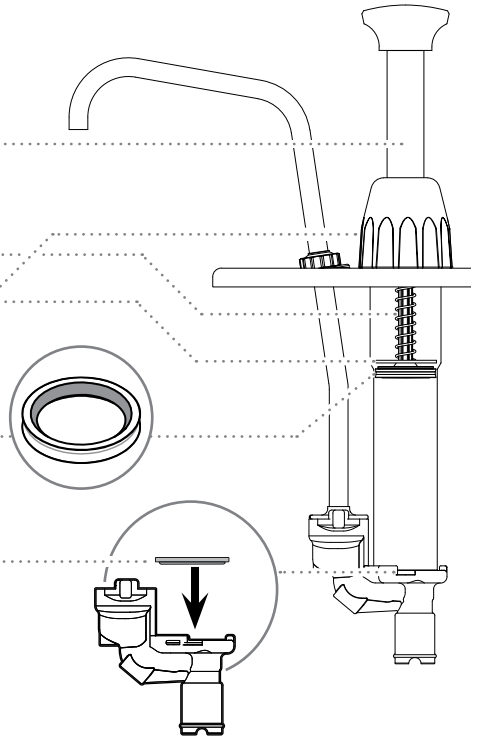

## SERVER PRODUCTS LIMITED WARRANTY

**2**  
YEAR  
WARRANTY

This Server product is backed by a two-year limited warranty against defects in materials and workmanship. See [Server-Products.com](http://Server-Products.com) for details.

## GENERAL SERVICE, REPAIR OR RETURNS

Before sending any item to Server Products for service, repair, or return, contact Server Products customer service to request a **Return Authorization Number**. Merchandise must be sent to Server Products with this number. Service is extremely prompt. Typically, units are repaired and ship out within 48 hours of receipt.

Merchandise being returned for credit must be in new and unused condition and not more than 90 days old and will be subject to a 20% restocking charge.

## NEED HELP?

**Server Products Inc.**  
3601 Pleasant Hill Road  
Richfield, WI 53076 USA

### Chat with us!

[spsales@server-products.com](mailto:spsales@server-products.com)

262.628.5600 | 800.558.8722

Please be prepared with your **Model, P/N** and **Series** located on the lid or base of the unit.

Example: 

MODEL XXXX	NSF <sub>®</sub>	SERIES ##X ##X
P/N #####		