

# Operator's Manual

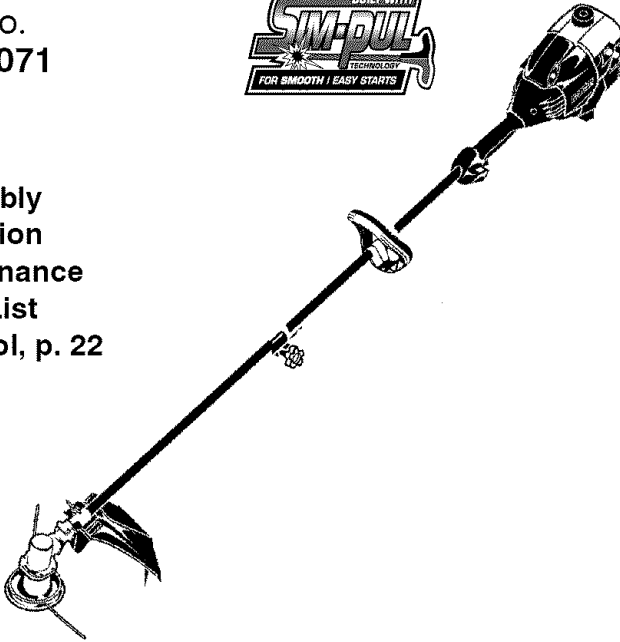

## 32cc/1.9 cu.in. 2-Cycle GASOLINE WEEDWACKER®

Model No.  
358.791071



- Safety
- Assembly
- Operation
- Maintenance
- Parts List
- Español, p. 22



### WARNING:

Read and follow all Safety Rules and Operating Instructions before first use of this product.



For answers to your questions about this product:  
Call 7 am–7 pm, Mon.–Sat., or 10 am–7 pm, Sun.

**1-800-235-5878** (Hours listed are Central Time)

Sears, Roebuck and Co., Hoffman Estates, IL 60179 U.S.A.

545154227 Rev. 1 7/3/07 BRW

## TABLE OF CONTENTS

Warranty Statement	2	Storage	16
Identification of Symbols	2	Troubleshooting Table	17
Safety Rules	3	Emissions Statement	18
Assembly	8	Parts List	20
Operation	10	Spanish	22
Maintenance	14	Parts and Ordering	Back Cover
Service & Adjustments	15		

## WARRANTY STATEMENT

### ONE YEAR FULL WARRANTY ON CRAFTSMAN® GAS WEEDWACKER®

When used and maintained according to the operator's manual, if this product fails due to a defect in material or workmanship within one year from the date of purchase, return it to any Sears store, Sears Service Center, or other Craftsman outlet in the United States for free repair (or replacement if repair proves impossible).

This warranty excludes cutting line, spark plug and air filter, which are expendable parts that can wear out from normal use in less than one year.

This warranty applies for only 30 days from purchase date if this product is used for commercial or rental purposes.

This warranty gives you specific legal rights, and you may also have other rights which vary from state to state.

Sears, Roebuck and Co., Hoffman Estates, IL 60179

## IDENTIFICATION OF SYMBOLS



**WARNING!** This trimmer can be dangerous! Careless or improper use can cause serious or even fatal injury.

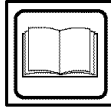

Read and understand the operator's manual before using the trimmer.



Always wear appropriate hearing protection, eye protection and head protection.

# SAFETY RULES

**⚠ WARNING:** When using gardening appliances, basic safety precautions must always be followed to reduce the risk of fire and serious injury. Read and follow all instructions. *This power unit can be dangerous!* Operator is responsible for following instructions and warnings on unit and in manual. Read entire operator's manual before using unit! Be thoroughly familiar with the controls and the proper use of the unit. Restrict the use of this unit to persons who have read, understand, and will follow the instructions and warnings on the unit and in the manual. Never allow children to operate this unit.



OPERATOR'S  
MANUAL



SAFETY INFORMATION  
ON THE UNIT

**⚠ DANGER:** Never use blades with line trimmer attachment. Never use flailing devices with any attachment. This unit (when used with supplied line trimmer attachment) is designed for line trimmer use only. Use of any other accessories with line trimmer attachment will increase the risk of injury.



**⚠ WARNING:** Trimmer line throws objects violently. You and others can be blinded/injured. Wear eye and leg protection. Keep body parts clear of rotating line.

Eye Protection

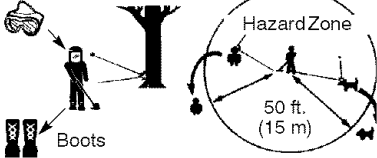

**⚠ WARNING:** Hazard zone for thrown objects. Trimmer line can throw objects violently. Others can be blinded or injured. Keep children, bystanders, and animals 50 feet (15 meters) away. Stop unit immediately if approached.

If situations occur which are not covered in this manual, use care and good judgment. If you need assistance, contact your Sears Service Center or call 1-800-235-5878.

## OPERATOR SAFETY

- Dress properly. Always wear safety glasses or similar eye protection when operating, or performing maintenance, on your unit (safety glasses are available). Eye protection should be marked Z87.
- Always wear face or dust mask if operation is dusty.
- Always wear heavy, long pants, long sleeves, boots, and gloves. Wearing safety leg guards is recommended.
- Always wear foot protection. Do not go barefoot or wear sandals. Stay clear of spinning line.
- Secure hair above shoulder length. Secure or remove loose clothing or clothing with loosely hanging ties, straps, tassels, etc. They can be caught in moving parts.
- Being fully covered also helps protect you from debris and pieces of toxic plants thrown by spinning line.
- Stay Alert. Do not operate this unit when you are tired, ill, upset or under the influence of alcohol, drugs, or medication. Watch what you are doing; use common sense.
- Wear hearing protection.
- Never start or run inside a closed room or building. Breathing exhaust fumes can kill.
- Keep handles free of oil and fuel.
- Always keep engine on the right hand side of your body.
- Hold the unit firmly with both hands.
- Keep trimmer head (or other optional attachment) below waist level and away from all parts of your body. Do not raise engine above your waist.
- Keep all parts of your body away from muffler and spinning line (or other optional attachment). A hot muffler can cause serious burns.
- Keep firm footing and balance. Do not overreach or use from unstable surfaces such as ladders, trees, steep slopes, rooftops, etc.
- Use only in daylight or good artificial light.
- Use only for jobs explained in this manual (or manuals for optional attachments).

## UNIT / MAINTENANCE SAFETY

**⚠ WARNING:** Disconnect the spark plug before performing maintenance except carburetor adjustments.

- Look for and replace damaged or loose parts before each use. Look for and repair fuel leaks before use. Keep in good working condition.
- Replace trimmer head parts that are chipped, cracked, broken, or damaged in any other way before using the unit.
- Maintain unit according to recommended procedures. Keep cutting line at proper length.
- Use only Craftsman® replacement line. Never use wire, rope, string, etc.
- Install required shield properly before using the unit. Use only specified trimmer head; make sure it is properly installed and securely fastened.
- Make sure unit is assembled correctly as shown in this manual.
- Make carburetor adjustments with lower end supported to prevent line from contacting any object.
- Keep others away when making carburetor adjustments.
- Use only recommended Craftsman accessories and replacement parts.
- Have all maintenance and service not explained in this manual performed by a Sears Service Center.

### FUEL SAFETY

- Mix and pour fuel outdoors.
- Keep away from sparks or flames.
- Do not smoke or allow smoking near fuel or the unit or while using the unit.
- Avoid spilling fuel or oil. Wipe up all fuel spills before starting engine.
- Move at least 10 feet (3 meters) away from fueling site before starting engine. Stop engine and allow it to cool before removing fuel cap.
- Empty the fuel tank before storing or transporting the unit. Use up fuel left in the carburetor by starting the engine and letting it run until it stops.
- Store unit and fuel in area where fuel vapors cannot reach sparks or open flames from water heaters, electric motors or switches, furnaces, etc.
- Always store gasoline in a container approved for flammable liquids.

### TRANSPORTING AND STORAGE

- Stop the unit before carrying.
- Allow engine to cool before storing or transporting in vehicle.

- Empty the fuel tank before storing or transporting the unit. Use up fuel left in the carburetor by starting the engine and letting it run until it stops.
- Store unit and fuel in area where fuel vapors cannot reach sparks or open flames from water heaters, electric motors or switches, furnaces, etc.
- Store unit so line limiter blade cannot accidentally cause injury. The unit can be hung by the shaft.
- Store unit out of reach of children.

This unit is not equipped with an anti-vibration system and is intended for occasional use only.

**SAFETY NOTICE:** Exposure to vibrations through prolonged use of gasoline powered hand tools could cause blood vessel or nerve damage in the fingers, hands, and joints of people prone to circulation disorders or abnormal swellings. Prolonged use in cold weather has been linked to blood vessel damage in otherwise healthy people. If symptoms occur such as numbness, pain, loss of strength, change in skin color or texture, or loss of feeling in the fingers, hands, or joints, discontinue the use of this tool and seek medical attention. An anti-vibration system does not guarantee the avoidance of these problems. Users who operate power tools on a continual and regular basis must monitor closely their physical condition and the condition of this tool.

**SPECIAL NOTICE:** This unit is equipped with a temperature limiting muffler and spark arresting screen which meets the requirements of California Codes 4442 and 4443. All U.S. forest land and the states of California, Idaho, Maine, Minnesota, New Jersey, Oregon, and Washington require by law that many internal combustion engines be equipped with a spark arresting screen. If you operate in a locale where such regulations exist, you are legally responsible for maintaining the operating condition of these parts. Failure to do so is a violation of the law. For normal homeowner use, the muffler and spark arresting screen will not require any service. After 50 hours of use, we recommend that your muffler be serviced or replaced by a Sears Service Center.

## LINE TRIMMER SAFETY

**⚠ WARNING:** Inspect the area to be trimmed before each use. Remove objects (rocks, broken glass, nails, wire, etc.) which can be thrown by or become entangled in line. Hard objects can damage the trimmer head and be thrown causing serious injury.

- Only use the trimmer attachment for trimming, scalping, mowing and sweeping. Do not use the trimmer attachment for edging, pruning or hedge trimming.
- Cut only from your left to your right. Cutting on right side of the shield will throw debris away from the operator.

## ADDITIONAL SAFETY RULES FOR OPTIONAL ATTACHMENTS

**⚠ WARNING:** For each optional attachment used, read entire operators manual before use and follow all warnings and instructions in manual and on attachment.

**⚠ WARNING:** Ensure handlebar is installed when using edger or brushcutter attachments. Attach handlebar above arrow on safety label on the upper shaft (engine end of unit). If your edger or brushcutter attachment does not include a handlebar, a handlebar accessory kit (#530071451) is available from your Sears Service Center.

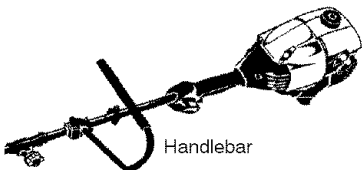

## EDGER SAFETY

**⚠ WARNING:** Inspect the area to be edged before each use. Remove objects (rocks, broken glass, nails, wire, etc.) which can be thrown by the blade or can wrap around the shaft.

- Blade rotates momentarily after the trigger is released. The blade can seriously cut you or others.
- Allow blade to stop before removing it from the cut.

*Blade rotates momentarily after the trigger is released.*

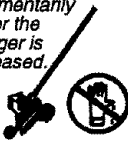

*Allow blade to stop before removing it from the cut.*



- Throw away blades that are bent, warped, cracked, broken or damaged in any other way. Replace parts that are cracked, chipped, or damaged before using the unit.
- Do not attempt to remove cut material nor hold material to be cut when the engine is running or when cutting blade is moving.
- Always keep the wheel and depth adjusting skid in contact with the ground.
- Always push the unit slowly over the ground. Stay alert for uneven sidewalks, holes in the terrain, large roots, etc.
- Always use the handlebar when using edger attachment.

## BLOWER/VACUUM SAFETY

**⚠ WARNING:** Inspect area before starting unit. Remove all debris and hard objects such as rocks, glass, wire, etc. that can ricochet, be thrown, or otherwise cause injury or damage during operation.

- Do not set unit on any surface except a clean, hard area while engine is running. Debris such as gravel, sand, dust, grass, etc., could be picked up by the air intake and thrown out through discharge opening, damaging unit, property, or causing serious injury to bystanders or operator.
- Never place objects inside the blower tubes, vacuum tubes or blower outlet. Always direct the blowing debris away from people, animals, glass, and solid objects such as trees, automobiles, walls, etc. The force of air can cause rocks, dirt, or sticks to be thrown or to ricochet which can hurt people or animals, break glass, or cause other damage.
- Never run unit without the proper equipment attached. When using your unit as a blower, always install blower tubes.

- Check air intake opening, blower tubes or vacuum tubes frequently, always with engine stopped and spark plug disconnected. Keep vents and discharge tubes free of debris which can accumulate and restrict proper air flow.
- Never place any object in air intake opening as this could restrict proper air flow and cause damage to the unit.
- Never use for spreading chemicals, fertilizers, or other substances which may contain toxic materials.
- To avoid spreading fire, do not use near leaf or brush fires, fireplaces, barbecue pits, ashtrays, etc.

### BRUSHCUTTER SAFETY

**⚠ DANGER:** Blade can thrust violently away from material it does not cut. Blade thrust can cause amputation of arms or legs.



**⚠ WARNING:** Do not use trimmer head as a fastening device for the blade.



- The blade continues to spin after the throttle is released or engine is turned off. The coasting blade can throw objects or seriously cut you if accidentally touched. Stop the blade by contacting the right hand side of the coasting blade with material already cut.

Stop coasting blade by contact with cut material.

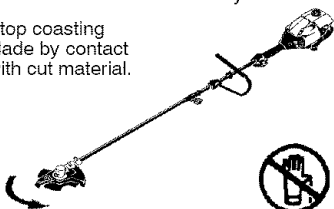

**⚠ WARNING:** Inspect the area to be cut before each use. Remove objects (rocks, broken glass, nails, wire,

- etc.) which can be thrown or become entangled in the blade or trimmer line.
- Throw away and replace blades that are bent, warped, cracked, broken or damaged in any other way.
  - Install required shield properly before using the unit. Use the metal shield for all metal blade use.

**⚠ WARNING:** Only use brushcutter attachments that provide a metal shield with protruding nose.

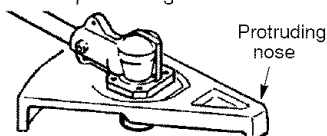

- Use only specified blade and make sure it is properly installed and securely fastened.
- Cut from your left to your right.
- Always use the handlebar and a properly adjusted shoulder strap with blade (see ASSEMBLY instructions in brushcutter attachment operator's manual).

### CULTIVATOR SAFETY

**⚠ WARNING:** Rotating tines can cause serious injury. Keep away from rotating tines. Stop the engine and disconnect the spark plug before unclogging tines or making repairs.



- ⚠ WARNING:** Inspect the area to be cultivated before starting the unit. Remove all debris and hard and sharp objects such as rocks, vines, branches, rope, string, etc.
- Avoid heavy contact with solid objects that might stop the tines. If heavy contact occurs, stop the engine and inspect the unit for damage.
  - Never operate the cultivator without the tine cover in place and properly secured.
  - Keep the tines and guard clear of debris.
  - After striking a foreign object, stop the engine, disconnect the spark plug and inspect the cultivator for damage. Repair before restarting.

- Disconnect attachment from the drive engine before cleaning the tines with a hose and water to remove any build-up. Oil the tines to prevent rust.
- Always wear gloves when servicing or cleaning the tines. The tines become very sharp from use.
- Do not run unit at high speed unless cultivating.

### HEDGE TRIMMER SAFETY

**⚠ DANGER:** RISK OF CUT; KEEP HANDS AWAY FROM BLADE - Blade moves momentarily after the trigger is released. Do not attempt to clear away cut material when the blade is in motion. Make sure the switch is in the OFF position, the spark plug wire is disconnected, and the blade has stopped moving before removing jammed material from the cutting blade. Do not grab or hold the unit by the cutting blade.

*Blades move momentarily after the trigger is released.*



*Allow blades to stop before removing them from the cut.*



**⚠ WARNING:** Inspect the area before starting the unit. Remove all debris and hard objects such as rocks, glass, wire, etc. that can ricochet, be thrown, or otherwise cause injury or damage during operation.

- Do not use a cutting blade that is bent, warped, cracked, broken or damaged in any other way. Have worn or damaged parts replaced by your Sears Service Center.
- Always keep unit in front of your body. Keep all parts of your body away from the cutting blade.
- Keep the cutting blade and air vents clear of debris.

### POLE PRUNER SAFETY

**⚠ WARNING:** The reciprocating blade/rotating chain can cause severe injury. Inspect the unit before use. Do not operate unit with a bent, cracked or dull blade or dull chain. Keep away from the blade/chain.

**⚠ WARNING:** The reciprocating blade/rotating chain is sharp. Do not touch. To prevent serious injury, always stop engine and ensure blade/chain has stopped moving, disconnect spark plug, and wear gloves when changing or handling the blade or chain.

**⚠ WARNING:** A coasting blade/rotating chain can cause injury while it continues to move after the engine is stopped. Maintain proper control of the unit until the blade/chain has completely stopped moving. Keep hands, face and feet at a distance from all moving parts. Do not attempt to touch or stop the blade or chain when it is moving.



**⚠ WARNING:** Falling objects can cause severe head injury. Wear head protection when operating this unit with a pole pruner attachment.



**⚠ WARNING:** To prevent serious injury, do not use more than one boom extension with a pole pruner attachment.

**⚠ WARNING:** Keep the pruner away from power lines or electrical wires.

- Only use for pruning limbs or branches up to 4 inches (10 cm) in diameter.
- Do not operate the unit faster than the speed needed to prune. Do not run the unit at high speed when not pruning.
- Always stop the unit when work is delayed or when walking from one cutting location to another.
- If you strike or become entangled with a foreign object, stop the engine immediately and check for damage. Have any damage repaired by a Sears Service Center before attempting further operations. Discard blades that are bent, warped, cracked or broken.
- Stop the unit immediately if you feel excessive vibration. Vibration is a sign of trouble. Inspect thoroughly for loose nuts, bolts or damage

before continuing. Contact Sears Service for repair or replacement of affected parts as necessary.

## SNOW THROWER SAFETY

**⚠ WARNING:** Keep hands and feet away from the rotor when starting or running the engine. Never attempt to clear the rotor with the engine/motor running. Stop engine and disconnect spark plug before unclogging snow or debris from discharge chute or when adjusting vanes.

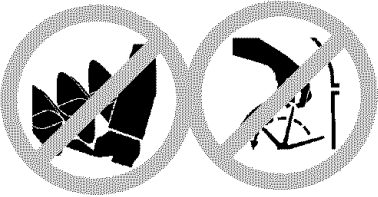

**⚠ WARNING:** Never lean over discharge chute. Rocks or debris could be thrown into the eyes and face and cause serious injury or blindness.

**⚠ WARNING:** Inspect the area where the unit is to be used. Remove objects that could be thrown or damage the unit. Some objects may be hidden by fallen snow -- be alert for the possibility.

- Direct material discharge away from glass enclosures, automobiles, etc.
- Do not run engine at high speed while not removing snow.
- Be attentive when using the snowthrower, and stay alert for holes in

the terrain and other hidden hazards.

- Make sure the rotor will spin freely before attaching the snowthrower to the powerhead.
- If the rotor will not rotate freely due to frozen ice, thaw the unit thoroughly before attempting to operate under power.
- Keep the rotor clear of debris.
- Do not throw snow near other people. The snow thrower could propel small objects at high speed causing injury.
- After striking a foreign object, stop the engine, disconnect spark plug and inspect the snowthrower for damage and repair if necessary before restarting unit.
- Never operate the snowthrower near glass enclosures, automobiles and trucks.
- Never attempt to use the snowthrower on a roof.
- Never operate the snowthrower near window wells, dropoffs, etc.
- Never discharge snow onto public roads or near moving traffic.
- Clear snow from slopes by going up and down; never across. Use caution when changing directions. Never clear snow from steep slopes.
- Let snowthrower run for a few minutes after clearing snow so moving parts do not freeze.
- Look behind and use care when backing up. Exercise caution to avoid slipping or falling, especially when operating in reverse.
- Know how to stop quickly.

## ASSEMBLY

### CARTON CONTENTS

Check carton contents against the following list.

#### Model 358.791071

- Powerhead
- Trimmer attachment
- Shield
- Wing Nut (screwed onto shield)
- Container of line
- Container of oil

Examine parts for damage. Do not use damaged parts.

**NOTE:** If you need assistance or find parts missing or damaged, call 1-800-235-5878.

It is normal for the fuel filter to rattle in the empty fuel tank.

Finding fuel or oil residue on muffler is normal due to carburetor adjustments and testing done by the manufacturer.

### ASSEMBLY

**⚠ WARNING:** Always stop unit and disconnect spark plug before performing any assembly procedures.

**⚠ WARNING:** If received assembled, repeat all steps to ensure your unit is properly assembled and all fasteners are secure.

### INSTALLING TRIMMER ATTACHMENT

**CAUTION:** When installing trimmer attachment, place the unit on a flat surface for stability.

1. Loosen the coupler by turning the knob counterclockwise.

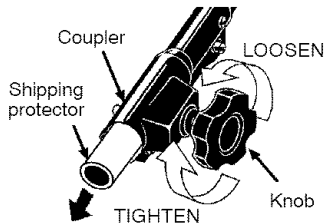

2. Remove shipping protector from coupler.
3. Remove the shaft cap from the trimmer attachment (if present).
4. Position locking/release button of attachment into guide recess of coupler.
5. Push the attachment into the coupler until the locking/release button snaps into the primary hole.
6. Before using the unit, tighten the knob securely by turning clockwise.

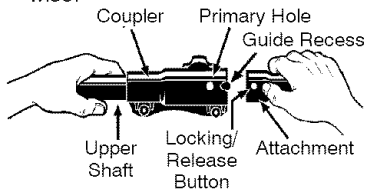

**WARNING:** Make sure the locking/release button is locked in the primary hole and the knob is securely tightened before operating the unit. All attachments are designed to be used in the primary hole unless otherwise stated in the applicable attachment operator's manual. Using the wrong hole could lead to serious injury or damage to the unit.

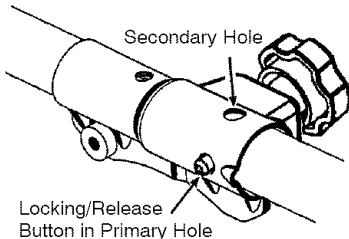

For optional attachments, see the ASSEMBLY section of the applicable attachment operator's manual.

## ATTACHING SHIELD

**WARNING:** The shield must be properly installed. The shield provides partial protection from the risk of thrown objects to the operator and others and is equipped with a line limiter blade which cuts excess line to the proper length. The line limiter blade (on underside of shield) is sharp and can cut you. For proper orientation of shield, see KNOW YOUR TRIMMER illustration in OPERATION section.

1. Remove wing nut from shield.
2. Insert bracket into slot as shown.
3. Pivot shield until bolt passes through hole in bracket.
4. Securely tighten wing nut onto bolt.

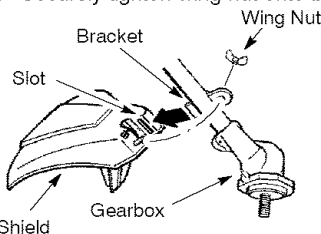

## ADJUSTING THE HANDLE

**WARNING:** When adjusting the assist handle, be sure it remains above the safety label and below the mark or arrow on the shaft.

1. Loosen wing nut on handle.
2. Rotate the handle on the shaft to an upright position; retighten wing nut.

# OPERATION

## KNOW YOUR TRIMMER

READ THIS OPERATOR'S MANUAL AND SAFETY RULES BEFORE OPERATING YOUR UNIT. Compare the illustrations with your unit to familiarize yourself with the location of the various controls and adjustments. Save this manual for future reference.

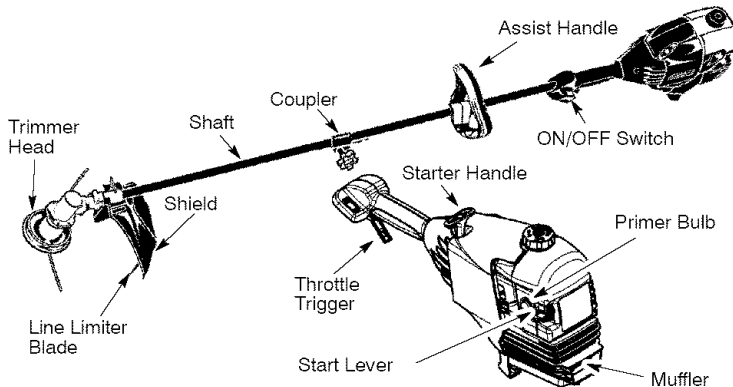

### ON/OFF SWITCH

The ON/OFF switch is located on the trigger handle and is used to stop the engine. Move the switch to the OFF position to stop the engine.

### PRIMER BULB

The PRIMER BULB removes air from the carburetor and fuel lines and fills them with fuel. This allows you to start the engine with fewer pulls on the starter rope. Activate the primer bulb by pressing it and allowing it to return to its original form.

### START LEVER

The START LEVER helps to supply fuel to the engine to aid in starting. Activate the starting system by moving the start lever to the START position. DO NOT squeeze the throttle trigger until the engine has started and runs. After the engine starts, allow the engine to warm-up 5 seconds, then fully squeeze the throttle trigger to deactivate the starting system (start lever returns to RUN position).

### COUPLER

The COUPLER enables optional attachments to be installed on the unit.

## BEFORE STARTING ENGINE

**WARNING:** Be sure to read the fuel information in the safety rules before you begin. If you do not understand the safety rules, do not attempt to fuel your unit. Call 1-800-235-5878.

### FUELING ENGINE

**WARNING:** Remove fuel cap slowly when refueling.

This engine is certified to operate on unleaded gasoline. Before operation, gasoline must be mixed with a good quality synthetic 2-cycle air-cooled engine oil. We recommend Craftsman brand synthetic oil. Mix gasoline and oil at a ratio of 40:1. A 40:1 ratio is obtained by mixing 3.2 ounces of oil with 1

gallon of unleaded gasoline. Included with this trimmer is a 3.2 ounce container of oil. Pour the entire contents of this container into 1 gallon of gasoline to achieve the proper fuel mixture. DO NOT USE automotive oil or marine oil. These oils will cause engine damage. When mixing fuel, follow instructions printed on container.

Once oil is added to gasoline, shake container momentarily to assure that the fuel is thoroughly mixed. Always read and follow the safety rules relating to fuel before fueling your unit.

### IMPORTANT

Alcohol blended fuels (called gasohol or using ethanol or methanol) can attract moisture which leads to separation and formation of acids during stor-

age. Acidic gas can damage the fuel system of an engine while in storage. To avoid engine problems, empty the fuel system before storage for 30 days or longer. Drain the gas tank, start the engine and let it run until the fuel lines and carburetor are empty. Use fresh fuel next season.

Never use engine or carburetor cleaner products in the fuel tank or permanent damage may occur.

See the STORAGE section for additional information.

### HOW TO STOP YOUR UNIT

- Release the throttle trigger.
- Move the ON/OFF switch to the OFF position.

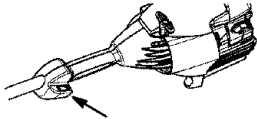

ON/OFF Switch

### HOW TO START YOUR UNIT

**WARNING:** Avoid any contact with the muffler. A hot muffler can cause serious burns.



Starting Position

### STARTING A COLD ENGINE

**NOTE:** DO NOT squeeze the throttle trigger until the engine has started and runs.

1. Set unit on a flat surface.
2. Move ON/OFF switch to the ON position.
3. Slowly press the primer bulb 6 times.
4. Move the start lever to the START position.

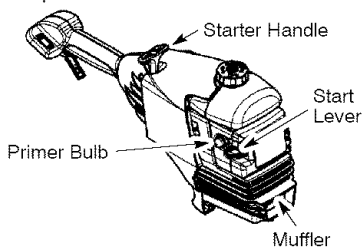

5. This unit has the Sim-pul™ starting system. You do not have to pull the starter rope handle sharply or briskly. Pull starter rope handle with a controlled and steady motion until engine starts and runs.
6. Allow unit to run for 5 seconds, then fully squeeze the throttle trigger to disengage the starting system (start lever returns to RUN position).

### STARTING A WARM ENGINE

1. Move ON/OFF switch to the ON position.
2. Squeeze and hold the throttle trigger. Keep throttle trigger fully squeezed until engine runs smoothly.
3. Pull starter rope handle with a controlled and steady motion while squeezing throttle trigger until engine starts and runs.

**NOTE:** Normally, the warm starting procedure can be used within 5-10 minutes after the unit is turned off. If the unit sits for more than 10 minutes without being used, it will be necessary to start the unit by following the steps under STARTING A COLD ENGINE or following the starting instruction steps shown on the unit.

### STARTING A FLOODED ENGINE

Flooded engines can be started by placing the ON/OFF switch in the ON position. Move the start lever to the RUN position and fully squeeze throttle trigger. Pull the starter rope handle repeatedly while squeezing throttle trigger until engine starts and runs. This could require pulling the starter rope handle many times, depending on how badly the unit is flooded.

If the unit still doesn't start, refer to TROUBLESHOOTING TABLE or call 1-800-235-5878.

### CRAFTSMAN® CONVERTIBLE™ FEATURE

This model is equipped with a coupler which enables optional attachments to be installed. The optional attachments are:

Edger .....	358.79240
Cultivator .....	358.79241
Blower .....	358.79242
Brushcutter .....	358.79244
Pruner .....	358.79245

**WARNING:** Always stop unit and disconnect spark plug before removing or installing attachments.

## REMOVING TRIMMER ATTACHMENT (OR OTHER OPTIONAL ATTACHMENTS)

**CAUTION:** When removing or installing attachments, place the unit on a flat surface for stability.

1. Loosen the coupler by turning the knob counterclockwise.

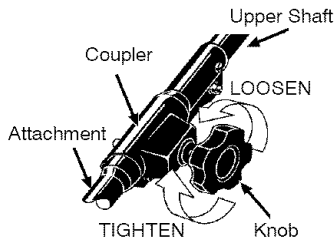

2. Press and hold the locking/release button.

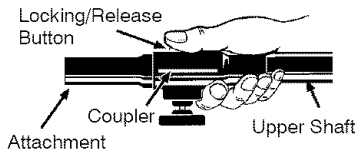

3. While securely holding the engine and upper shaft, pull the attachment straight out of the coupler.

## INSTALLING OPTIONAL ATTACHMENTS

1. Remove the shaft cap from the attachment (if present).
2. Position locking/release button of attachment into guide recess of coupler.
3. Push the attachment into the coupler until the locking/release button snaps into the primary hole.
4. Before using the unit, tighten the knob securely by turning clockwise.

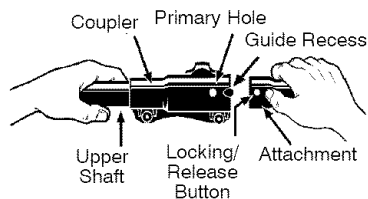

**WARNING:** Make sure the locking/release button is locked in the primary hole and the knob is securely tightened before operating the unit. All attachments are designed to be used in the primary hole unless otherwise stated in the applicable attachment op-

erator's manual. Using the wrong hole could lead to serious injury or damage to the unit.

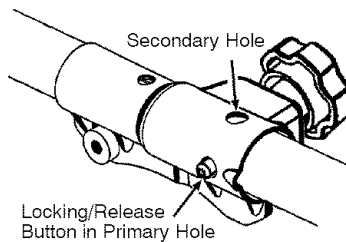

## OPERATING INSTRUCTIONS

To maximize operating efficiency, do not run the engine for longer than 1 minute at a time at full throttle.

### OPERATING POSITION

ALWAYS USE:

Hearing Protection      Eye Protection

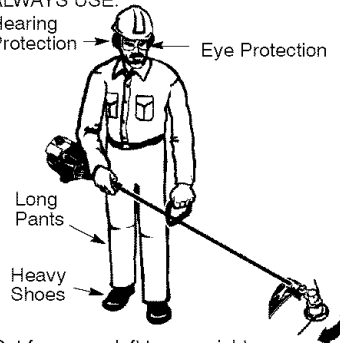

Cut from your left to your right.

**WARNING:** Always wear eye protection and hearing protection. Never lean over the trimmer head. Rocks or debris can ricochet or be thrown into eyes and face and cause blindness or other serious injury.

When operating unit, stand as shown and check for the following:

- Wear eye protection, hearing protection and heavy clothing.
- Hold trigger handle with right hand and assist handle with left hand.
- Hold unit so that engine is below waist level.
- Cut only from your left to your right to ensure debris is thrown away from you. Without bending over, keep line near and parallel to the ground and not crowded into material being cut.

Do not run the engine at a higher speed than necessary. The cutting line will cut efficiently when the engine is run at less than full throttle. At lower speeds, there is less engine noise and vibration.

Always release the throttle trigger and allow the engine to return to idle speed when not cutting.

#### HOW TO STOP YOUR UNIT

- Release the throttle trigger.
- Move the ON/OFF switch to the OFF position.

#### CUTTING METHODS

**⚠ WARNING:** Use minimum speed and do not crowd the line when cutting around hard objects (rock, gravel, fence posts, etc.), which can damage the trimmer head, become entangled in the line, or be thrown causing a serious hazard.

- The tip of the line does the cutting. You will achieve the best performance and minimum line wear by not crowding the line into the cutting area. The right and wrong ways are shown below.

Tip of line does the cutting.

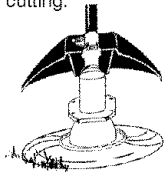

Right

Line crowded into work area.



Wrong

- The line will easily remove grass and weeds from around walls, fences, trees and flower beds, but it also can cut the tender bark of trees or shrubs and scar fences.
- For trimming or scalping, use less than full throttle to increase line life and decrease head wear, especially:
  - During light duty cutting.
  - Near objects around which the line can wrap such as small posts, trees or fence wire.

**TRIMMING** - Hold the bottom of the trimmer head about 3 inches (8 cm) above the ground and at an angle. Allow only the tip of the line to make contact with vegetation. Do not force trimmer line into work area.

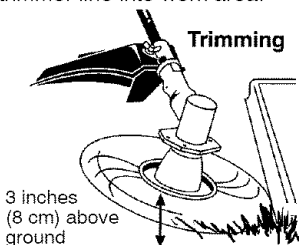

Trimming

**SCALPING** - The scalping technique removes unwanted vegetation down to the ground. Hold the bottom of the trimmer head about 3 inches (8 cm) above the ground and at an angle. Allow the tip of the line to strike the ground around trees, posts, monuments, etc. This technique increases line wear.

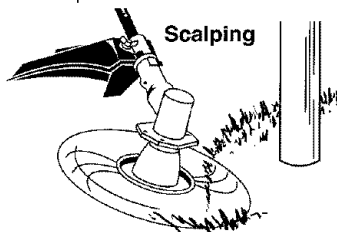

**MOWING** - Your trimmer is ideal for mowing in places conventional lawn mowers cannot reach. In the mowing position, keep the line parallel to the ground. Avoid pressing the head into the ground as this can scalp the ground and damage the tool.

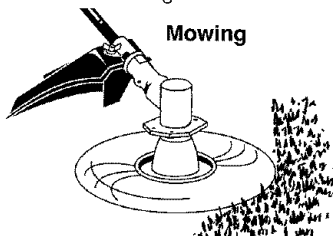

**SWEEPING** - The fanning action of the rotating line can be used to blow away loose debris from an area. Keep the line parallel to and above the area surface and swing the tool from side to side.



# MAINTENANCE

## MAINTENANCE SCHEDULE

**⚠ WARNING:** Disconnect the spark plug before performing maintenance except for carburetor adjustments.

CARE & MAINTENANCE TASK	WHEN TO PERFORM
Check for loose fasteners and parts	Before each use
Check for damaged or worn parts	Before each use
Inspect and clean unit and decals	After each use
Clean air filter	Every 5 hours of operation
Inspect muffler and spark arresting screen	Every 50 hours of operation
Replace spark plug	Yearly

## GENERAL RECOMMENDATIONS

The warranty on this unit does not cover items that have been subjected to operator abuse or negligence. To receive full value from the warranty, the operator must maintain unit as instructed in this manual. Various adjustments will need to be made periodically to properly maintain your unit.

### CHECK FOR LOOSE FASTENERS AND PARTS

- Spark Plug Boot
- Air Filter
- Housing Screws
- Assist Handle Screw
- Debris Shield

### CHECK FOR DAMAGED OR WORN PARTS

Contact Sears Service Center for replacement of damaged or worn parts.

- ON/OFF Switch - Ensure ON/OFF switch functions properly by moving the switch to the OFF position. Make sure engine stops; then restart engine and continue.
- Fuel Tank - Discontinue use of unit if fuel tank shows signs of damage or leaks.
- Debris Shield - Discontinue use of unit if debris shield is damaged.

### INSPECT AND CLEAN UNIT AND DECALS

- After each use, inspect complete unit for loose or damaged parts. Clean the unit and decals using a damp cloth with a mild detergent.
- Wipe off unit with a clean dry cloth.

## CLEAN AIR FILTER

A dirty air filter decreases engine performance and increases fuel consumption and harmful emissions. Always clean after every 5 hours of operation.

1. Clean the cover and the area around it to keep dirt from falling into the carburetor chamber when the cover is removed.
2. Remove parts by pressing button to release air filter cover.

**NOTE:** To avoid creating a fire hazard or producing harmful evaporative emissions, do not clean filter in gasoline or other flammable solvent.

3. Wash the filter in soap and water.
4. Allow filter to dry.
5. Replace parts.

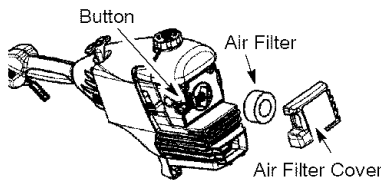

## INSPECT MUFFLER AND SPARK ARRESTING SCREEN

**⚠ WARNING:** The muffler on this product contains chemicals known to the State of California to cause cancer. As your unit is used, carbon deposits build up on the muffler and spark arresting screen.

For normal homeowner use, however, the muffler and spark arresting screen will not require any service. After 50 hours of use, we recommend that your muffler be serviced or replaced by your Sears Service Center.

## REPLACE SPARK PLUG

Replace the spark plug each year to ensure the engine starts easier and runs better. Set spark plug gap at 0.025 inch. Ignition timing is fixed and nonadjustable.

1. Twist, then pull off spark plug boot.
2. Remove spark plug from cylinder and discard.
3. Replace with Champion RCJ-6Y spark plug and tighten securely with a 3/4 inch socket wrench.
4. Reinstall the spark plug boot.

## SERVICE AND ADJUSTMENTS

### LINE REPLACEMENT

- Always use Craftsman replacement line.

Choose the line size best suited for the job at hand. Red line (#71-85908) is designed for cutting grass and small weeds. The black colored line (#71-85909) is designed for cutting larger weeds and light brush.

**NOTE:** Before inserting new line into the holes in the cutting head, identify the proper holes. Follow directions as shown on the line glide plate.

1. Remove the old line and line glide plate from the cutting head.
2. Clean entire surface of cutting head.
3. Reinstall line glide plate (see illustration). Align arrow with:

(A) when using medium (red) or large (black) line

(B) when using lines with diameter smaller than medium (red) line (optional)

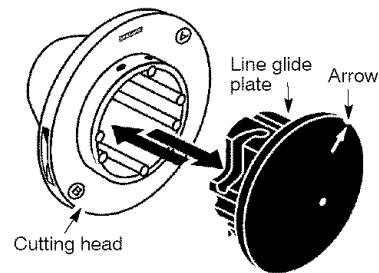

**NOTE:** Line glide plate must be reinstalled in cutting head before inserting new line.

4. Insert both ends of your line through the proper holes in the side of the cutting head.

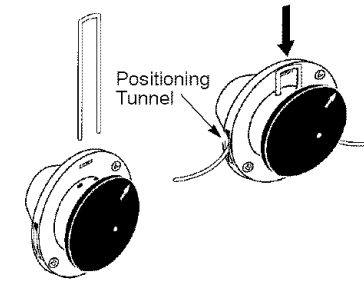

5. Pull the line and make sure the line is against the hub and extended full through the positioning tunnels.



6. Correctly installed line will be the same length on both ends.

### REPLACING THE TRIMMER HEAD

1. Align hole in the dust cup with the hole in the side of the gearbox by rotating the arbor shaft.
2. Insert a small screwdriver into aligned holes. This will keep the shaft from turning while removing and installing trimmer head.

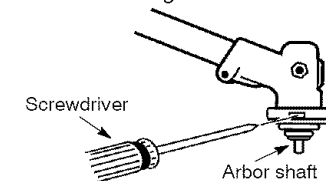

3. While holding the screwdriver in position, remove trimmer head by turning clockwise.
4. Thread replacement trimmer head onto the shaft by turning counter-clockwise. **Only tighten hand tight!**
5. Remove the screwdriver.

## CARBURETOR ADJUSTMENT

**⚠ WARNING:** Keep others away when making idle speed adjustments. The trimmer head will be spinning during most of this procedure. Wear your protective equipment and observe all safety precautions. After making adjustments, the trimmer head must not move or spin at idle speed.

The carburetor has been carefully set at the factory. Adjustments may be necessary if you notice any of the following conditions:

- Engine will not idle when the throttle is released.
- The trimmer head moves or spins at idle.

Make adjustments with the unit supported so the cutting attachment is off the ground and will not make contact with any object. Hold the unit by hand while running and making adjustments. Keep all parts of your body away from the cutting attachment and muffler.

### Idle Speed Adjustment

Allow engine to idle. Adjust speed until engine runs without trimmer head moving or spinning (idle too fast) or engine stalling (idle speed too slow).

- Turn idle speed screw clockwise to increase engine speed if engine stalls or dies.
- Turn idle speed screw counterclockwise to decrease engine speed if trimmer head moves or spins at idle.

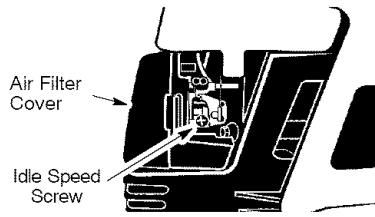

**⚠ WARNING:** Recheck the idle speed after each adjustment. The trimmer head must not move or spin at idle speed to avoid serious injury to the operator or others.

If you require further assistance or are unsure about performing this procedure, contact your Sears Service Center or call our customer assistance help line at 1-800-235-5878.

## STORAGE

**⚠ WARNING:** Perform the following steps after each use:

- Allow engine to cool before storing or transporting.
- Store unit and fuel in a well ventilated area where fuel vapors cannot reach sparks or open flames from water heaters, electric motors or switches, furnaces, etc.
- Store unit with all guards in place. Position unit so that any sharp object cannot accidentally cause injury.
- Store unit and fuel well out of the reach of children.

### SEASONAL STORAGE

Prepare unit for storage at end of season or if it will not be used for 30 days or more.

If your unit is to be stored for a period of time:

- Clean the entire unit before lengthy storage.
- Store in a clean dry area.
- Lightly oil external metal surfaces.

### FUEL SYSTEM

Empty the fuel system before storage for 30 days or longer. Drain the gas tank, start the engine and let it run until the fuel lines and carburetor are empty. Use fresh fuel next season.

Under FUELING ENGINE in the OPERATION section of this manual, see message labeled **IMPORTANT** regarding the use of gasohol in your engine.

Fuel stabilizer is an acceptable alternative in minimizing the formation of fuel gum deposits during storage. Add stabilizer to the gasoline in the fuel tank or fuel storage container. Follow the mix instructions found on stabilizer container. Run engine at least 3 minutes after adding stabilizer.

Craftsman 40:1, 2-cycle engine oil (air cooled) is already blended with fuel stabilizer. If you do not use this Sears oil, you can add a fuel stabilizer to your fuel tank.

## ENGINE

- Remove spark plug and pour 1 teaspoon of 40:1, 2-cycle engine oil (air cooled) through the spark plug opening. Slowly pull the starter rope 8 to 10 times to distribute oil.
- Replace spark plug with new one of recommended type and heat range.
- Clean air filter.
- Check entire unit for loose screws, nuts, and bolts. Replace any damaged, broken, or worn parts.
- At the beginning of the next season, use only fresh fuel having the proper gasoline to oil ratio.

## OTHER

- Do not store gasoline from one season to another.
- Replace your gasoline can if it starts to rust.

## TROUBLESHOOTING TABLE

**⚠ WARNING:** Always stop unit and disconnect spark plug before performing all of the recommended remedies below except remedies that require unit to be operating.

TROUBLE	CAUSE	REMEDY
Engine will not start.	1. ON/OFF switch in OFF position. 2. Engine flooded. 3. Fuel tank empty. 4. Spark plug not firing. 5. Fuel not reaching carburetor. 6. Carburetor requires adjustment.	1. Move ON/OFF switch to the ON position. 2. See "Starting a Flooded Engine" in Operation Section. 3. Fill tank with correct fuel mixture. 4. Install new spark plug. 5. Check for dirty fuel filter; replace. Check for kinked or split fuel line; repair or replace. 6. Contact Sears Service (see back cover).
Engine will not idle properly.	1. Carburetor requires adjustment. 2. Crankshaft seals worn. 3. Compression low.	1. See "Carburetor Adjustment" in Service and Adjustments Section. 2. Contact Sears Service (see back cover). 3. Contact Sears Service (see back cover).
Engine will not accelerate, lacks power, or dies under a load.	1. Air filter dirty. 2. Spark plug fouled. 3. Carburetor requires adjustment. 4. Carbon build-up on muffler outlet screen. 5. Compression low.	1. Clean or replace air filter. 2. Clean or replace plug and regap. 3. Contact Sears Service (see back cover). 4. Contact Sears Service (see back cover). 5. Contact Sears Service (see back cover).
Engine smokes excessively.	1. Fuel mixture incorrect. 2. Air filter dirty. 3. Carburetor requires adjustment.	1. Empty fuel tank and refill with correct fuel mixture. 2. Clean or replace air filter. 3. Contact Sears Service (see back cover).
Engine runs hot.	1. Fuel mixture incorrect. 2. Spark plug incorrect. 3. Carburetor requires adjustment. 4. Carbon build-up on muffler outlet screen.	1. See "Fueling Engine" in Operation section. 2. Replace with correct spark plug. 3. Contact Sears Service (see back cover). 4. Contact Sears Service (see back cover).

## U.S. EPA / CALIFORNIA EMISSION CONTROL WARRANTY STATEMENT

### **YOUR WARRANTY RIGHTS AND OBLIGATIONS:**

The U.S. Environmental Protection Agency/California Air Resources Board and Sears, Roebuck and Co., U.S.A., are pleased to explain the emissions control system warranty on your year 2007 and later small off-road engine. In California, all small off-road engines must be designed, built, and equipped to meet the State's stringent anti-smog standards. Sears must warrant the emission control system on your small off-road engine for the periods of time listed below provided there has been no abuse, neglect, or improper maintenance of your small off-road engine. Your emission control system includes parts such as the carburetor, the ignition system and the fuel tank (California only). Where a warrantable condition exists, Sears will repair your small off-road engine at no cost to you. Expenses covered under warranty include diagnosis, parts and labor.

### **MANUFACTURER'S WARRANTY COVERAGE:**

If any emissions related part on your engine (as listed under Emissions Control Warranty Parts List) is defective or a defect in the materials or workmanship of the engine causes the failure of such an emission related part, the part will be repaired or replaced by Sears. **OWNER'S WARRANTY RESPONSIBILITIES:** As the small off-road engine owner, you are responsible for the performance of the required maintenance listed in your operator's manual. Sears recommends that you retain all receipts covering maintenance on your small off-road engine, but Sears cannot deny warranty solely for the lack of receipts or for your failure to ensure the performance of all scheduled maintenance. As the small off-road engine owner, you should be aware that Sears may deny you warranty coverage if your small off-road engine or a part of it has failed due to abuse, neglect, improper maintenance, unapproved modifications, or the use of parts not made or approved by the original equipment manufacturer. You are responsible for presenting your small off-road engine to a Sears authorized repair center as soon as a problem exists. Warranty repairs should be completed in a reasonable amount of time, not to exceed 30 days. If you have any questions regarding your warranty rights

and responsibilities, you should contact your nearest authorized service center or call Sears at 1-800-469-4663.

### **WARRANTY COMMENCEMENT**

**DATE:** The warranty period begins on the date the small off-road engine is purchased. **LENGTH OF COVERAGE:**

This warranty shall be for a period of two years from the initial date of purchase. **WHAT IS COVERED: REPAIR OR REPLACEMENT OF PARTS.** Repair or replacement of any warranted part will be performed at no charge to the owner at an approved Sears Service Center. If you have any questions regarding your warranty rights and responsibilities, you should contact your nearest authorized service center or call Sears at 1-800-469-4663. **WARRANTY PERIOD:** Any warranted part which is not scheduled for replacement as required maintenance, or which is scheduled only for regular inspection to the effect of "repair or replace as necessary" shall be warranted for 2 years. Any warranted part which is scheduled for replacement as required maintenance shall be warranted for the period of time up to the first scheduled replacement point for that part. **DIAGNOSIS:**

The owner shall not be charged for diagnostic labor which leads to the determination that a warranted part is defective if the diagnostic work is performed at an approved Sears Service Center. **CONSEQUENTIAL DAMAGES:** Sears may be liable for damages to other engine components caused by the failure of a warranted part still under warranty. **WHAT IS NOT COVERED:** All failures caused by abuse, neglect, or improper maintenance are not covered. **ADD-ON OR MODIFIED PARTS:** The use of add-on or modified parts can be grounds for disallowing a warranty claim. Sears is not liable to cover failures of warranted parts caused by the use of add-on or modified parts. **HOW TO FILE A CLAIM:** If you have any questions regarding your warranty rights and responsibilities, you should contact your nearest authorized service center or call Sears at 1-800-469-4663. **WHERE TO GET WARRANTY SERVICE:** Warranty services or repairs shall be provided at all Sears Service Centers. Call 1-800-469-4663.

**MAINTENANCE, REPLACEMENT AND REPAIR OF EMISSION RELATED PARTS:** Any Sears approved replacement part used in the performance of any warranty maintenance or repair on emission related parts will be provided without charge to the owner if the part is under warranty.

**EMISSION CONTROL WARRANTY PARTS LIST:** Carburetor, Ignition System: Spark Plug (covered up to maintenance schedule), Ignition Module, Muffler including catalyst, Fuel Tank (California only). **MAINTENANCE STATEMENT:** The owner is responsible for the performance of all required maintenance as defined in the operator's manual.

---

The information on the product label indicates which standard your engine is certified. Example: (Year) EPA Phase 1 or Phase 2 and/or CALIFORNIA.

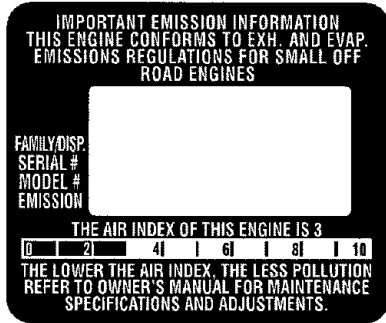

---

This engine is certified to be emissions compliant for the following use:

- Moderate (50 hours)
- Intermediate (125 hours)
- Extended (300 hours)

# REPAIR PARTS

SEARS TRIMMER MODEL 358.791071

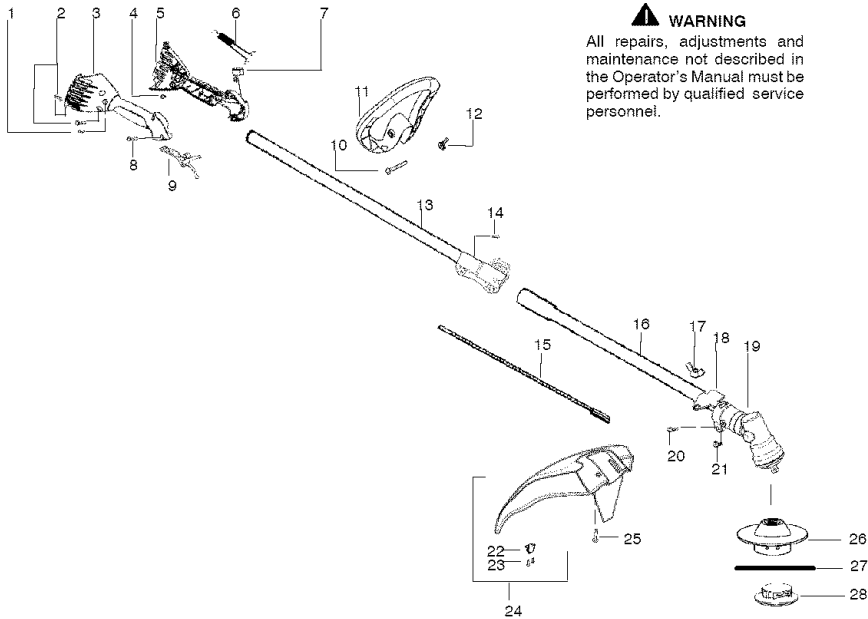

**▲ WARNING**  
 All repairs, adjustments and maintenance not described in the Operator's Manual must be performed by qualified service personnel.

Ref	Part No.	Description	Ref.	Part No.	Description
1.	530015805	Screw-alignment	20.	530018014	Screw
2.	530015886	Screw	21.	530015775	Screw
3.	530057983	Hsg.-Throttle right	22.	530052285	Limiter-Line
4.	530016326	Screw-Cable Retention	23.	530015814	Screw
5.	530057984	Hsg.-Left throttle	24.	530071765	Kit-Shield Assy. (incl. 22,23)
6.	530058843	Assy-Wire	25.	530015820	Bolt
7.	530069572	Kit-Switch	26.	71-85740	Head-Cutting
8.	530015886	Screw	27.	---	Tube-Twisted Line
9.	545017701	Lever-Trigger	71-85908		Red Line
10.	530015786	Bolt	71-85909		Black Line
11.	530058583	Assy-Handle (Incl. 10,12)	28.	530096039	Plate-Glide
12.	530016152	Wingnut			
13.	530071936	Kit-Upper Shaft (Incl. flex, clamp & 14)			
14.	530016344	Screw			Not Shown
15.	530096218	Shaft-Flex (lower)			
16.	530071789	Kit-Lower Shaft			
17.	530016152	Wingnut			
18.	530057554	Bracket-Shield	545154227		Operator Manual
19.	530096099	Gearbox	530056220		Decal-Shaft Warning
			530057296		Decal-Upper Shaft

# REPAIR PARTS

## WARNING

All repairs, adjustments and maintenance not described in the Operator's Manual must be performed by qualified service personnel.

SEARS TRIMMER MODEL 358.791071

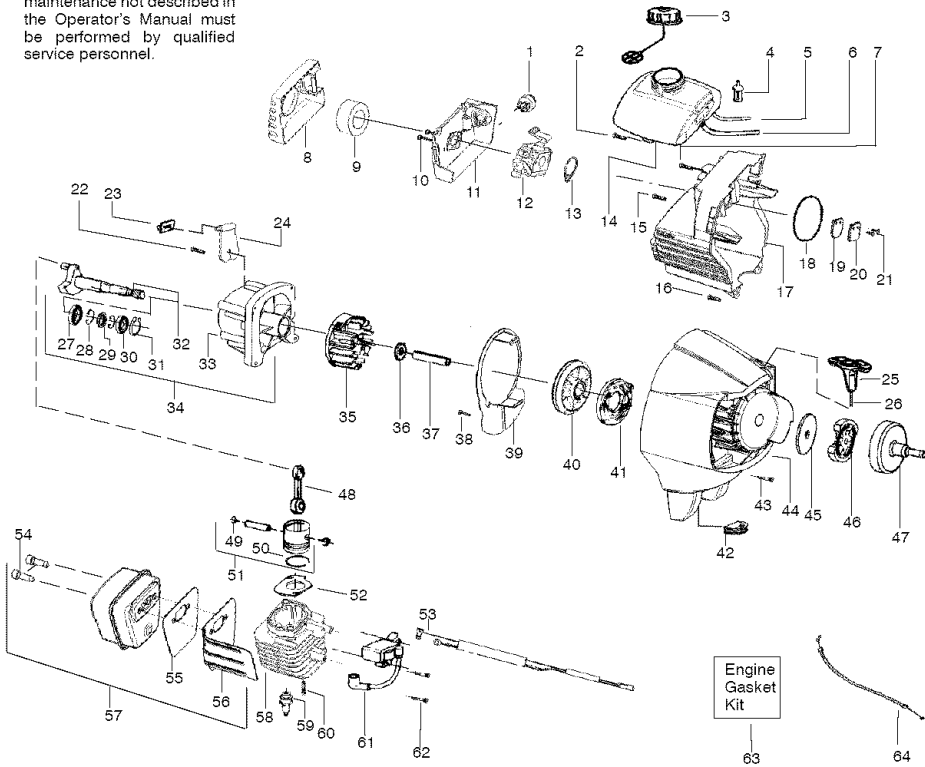

Ref.	Part No.	Description	Ref.	Part No.	Description	Ref.	Part No.	Description
1.	530047721	Bulb-Purge	24.	530054941	Ret.-Tank	47.	530150247	Assy-Drum/Adapter
2.	530015843	Screw-tank	25.	530054834	Handle-Starter	48.	530010960	Assy-Conn. Rod
3.	530049386	Cap-Fuel w/ret.	26.	545050410	Kit-Rope	49.	530015162	Ret.-Piston pin
4.	530014362	Assy-Fuel pickup	27.	545081601	Bearing-Inner	50.	530012594	Ring-Piston
5.	530071404	Kit-Fuel line	28.	530015787	Retainer	51.	530071998	Kit-Piston (Incl. 49,50)
6.	530069216	Kit-Fuel/Purge line	29.	530019158	Seal	52.	545030102	Gasket-Cylinder(kit)
7.	530015775	Screw	30.	530032102	Bearing-Outer	53.	530058846	Assy-Leadwire
8.	545000501	Cover-Air box	31.	530015789	Ret.-Crankshaft	54.	530016387	Bolt-Muffler 1/4"-20
9.	545082301	Filter-Air	32.	530028807	Assy-Crankshaft	55.	545030102	Gasket-Muffler (kit)
10.	530015849	Screw-Carb.	33.	545081901	Assy-Crankcase ( Incl. 27,28,29,30)	56.	545033201	Shield
11.	545000601	Box-Air	34.	545006037	Assy-C'case/C'shaft ( Incl. 31,32,33)	57.	545081871	Kit-Muffler (Incl. 54,55,56)
12.	545006017	Kit-Carb assy.(C1U-W32)	35.	530055524	Assy-Flywheel	58.	530012586	Cylinder
(Note: Repair kits are not available for this carburetor)			36.	530016030	Washer	59.	952030249	Plug-Spark(RCJ-6Y)
13.	545030102	Seal-Carb. (kit)	37.	530055620	Spacer	60.	530001624	Bolt-Cyl. 1/4"-20
14.	545103602	Assy-Fuel Tank	38.	530015775	Screw-Baffle	61.	530039234	Module-Ignition
15.	530015952	Screw-Shroud	39.	545115201	Plate-Baffle	62.	530016357	Screw-Module
16.	545000701	Assy-Rear Shroud	40.	545050408	Kit-Pulley	63.	545030102	Kit-Gasket/Seal ( Incl. 13,18, 52,55)
17.	545030102	O-ring-Shroud (kit)	41.	545054901	Spring-Starter	64.	545026801	Assy-Throttle cable
18.	530027593	Valve-Reed	42.	530019182	Grommet			
19.	530029781	Stop-Reed	43.	530016386	Screw-F/hsg.			
20.	530016064	Screw-Reed stop	44.	530059278	Assy-Fan Housing			
21.	530015875	Screw-Retainer	45.	530094189	Washer-Clutch			
22.	530055492	Isolator-Tank	46.	530055122	Assy-Clutch			
23.								