

	mm (inches / pulgadas / po / pol.)					kg (lbs / libras / lb)	
	A	B	C	D	E	F	F-G
55QNE84B*	1 236 (48.6)	780 (30.7)	230 (9.0)	718 (28.2)	67.9 (2.6)	11.6 (25.5)	11.5 (25.3)
65QNE84B*	1 455 (57.2)	904 (35.5)	269 (10.5)	841 (33.1)	67.9 (2.6)	17.0 (37.4)	16.8 (37.0)
75QNE84B*	1 667 (65.6)	1 026 (40.3)	361 (14.2)	962 (37.8)	66.8 (2.6)	21.6 (47.6)	21.2 (46.7)
85QNE84B*	1 889 (74.3)	1 149 (45.2)	362 (14.2)	1 087 (42.7)	67.0 (2.6)	28.6 (63.0)	27.9 (61.5)

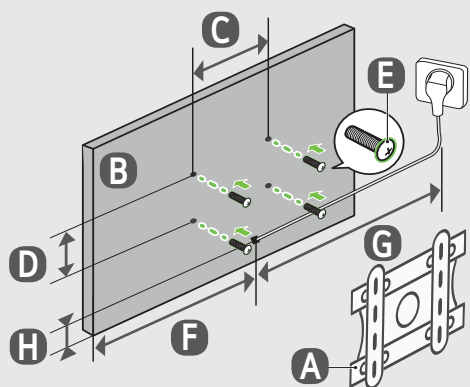

* : 0~9, A~Z
mm (inches / pulgadas / po / pol.)

A	B	C x D	E	F	G	H
OLW480B MSW240	55QNE84B*	300 x 200 mm (11.8 x 7.8) inches	M6	775 mm (30.5) inches	≥ 1.5 m (590) inches	228 mm (8.9) inches
OLW480B	65QNE84B*			878 mm (34.5) inches		245 mm (9.6) inches
	75QNE84B*			1 311 mm (51.6) inches		339 mm (13.3) inches
WB24GCB	85QNE84B*	400 x 400 mm (15.7 x 15.7) inches		1 473 mm (57.9) inches		358 mm (14.0) inches

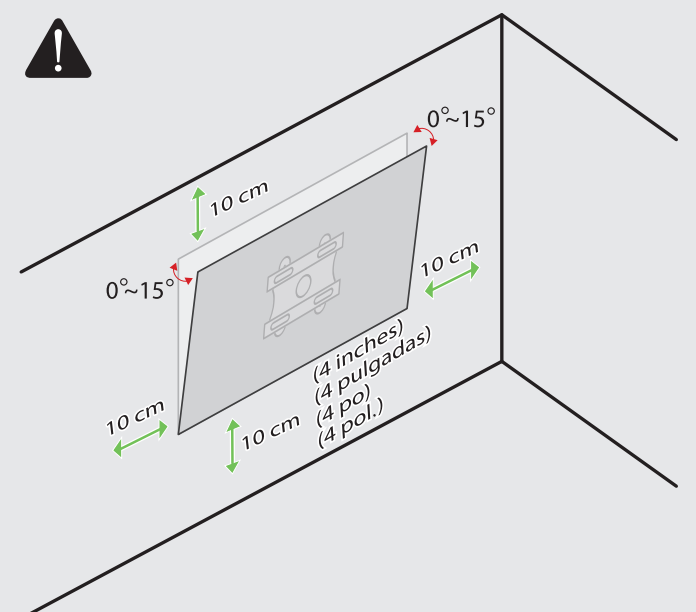

Printed in Korea
Imprimé en Corée

LED TV*

OWNER'S MANUAL

Safety and Reference

* LG LED TV applies LCD screen with LED backlights.

Please read this manual carefully before operating your set and retain it for future reference.

24LB7000PUA	75NU700BPJA	50NU860BYUA	65QNED74BAA
27LB7000PUA	85NU700BPJA	55NU860BYUA	75QNED74BAA
32LB650BPJA	50NU710BAUA	65NU860BYUA	85QNED74BAA
43LB6500PUA	55NU710BAUA	75NU860BYUA	43QNED74BUA
50MRGB85BAA	65NU710BAUA	85NU860BYUA	50QNED74BUA
55MRGB85BAA	75NU710BAUA	85NU870BAUA	55QNED74BUA
65MRGB85BAA	85NU710BAUA	55QNED75BUA	65QNED74BUA
75MRGB85BAA	50NU830BZUA	65QNED75BUA	75QNED74BUA
86MRGB85BAA	55NU830BZUA	75QNED75BUA	85QNED74BUA
50MRGB85BUA	65NU830BZUA	85QNED75BUA	43QNED75BAA
55MRGB85BUA	75NU830BZUA	43QNED73BUA	50QNED75BAA
65MRGB85BUA	85NU830BZUA	50QNED73BUA	55QNED75BAA
75MRGB85BUA	50NU850BAUA	55QNED73BUA	65QNED75BAA
86MRGB85BUA	55NU850BAUA	65QNED73BUA	75QNED75BAA
50MRGB89BYA	65NU850BAUA	75QNED73BUA	85QNED75BAA
55MRGB89BYA	75NU850BAUA	85QNED73BUA	43QNED75BUA
65MRGB89BYA	50NU850BPJA	43QNED73BZA	50QNED75BUA
75MRGB89BYA	55NU850BPJA	50QNED73BZA	55QNED75BUA
86MRGB89BYA	65NU850BPJA	55QNED73BZA	65QNED75BUA
75MRGB95BUA	75NU850BPJA	65QNED73BZA	75QNED75BUA
86MRGB95BUA	85NU850BPJA	75QNED73BZA	85QNED75BUA
100MRGB95BU	50NU855BAUA	85QNED73BZA	43QNED76BAA
50NU700BPJA	55NU855BAUA	43QNED74BAA	50QNED76BAA
55NU700BPJA	65NU855BAUA	50QNED74BAA	55QNED76BAA
65NU700BPJA	75NU855BAUA	55QNED74BAA	65QNED76BAA

The model and serial number of the product are located on the back and on one side of the product. Record them below in case you ever need service.

Model _____

Serial No. _____



ENGLISH

www.lg.com

Copyright © 2026 LG Electronics Inc.
All Rights Reserved.

75QNED76BAA	85QNED85BUA	75QNED84BAA
85QNED76BAA	55QNED75BAA	85QNED84BAA
50QNED85BAA	65QNED75BAA	55QNED84BUA
55QNED85BAA	75QNED75BAA	65QNED84BUA
65QNED85BAA	85QNED75BAA	75QNED84BUA
75QNED85BAA	55QNED82BUA	85QNED84BUA
85QNED85BAA	65QNED82BUA	100QNED84BU
50QNED85BUA	75QNED82BUA	
55QNED85BUA	85QNED82BUA	
65QNED85BUA	55QNED84BAA	
75QNED85BUA	65QNED84BAA	

Supplier`s Declaration of Conformity

Trade Name	LG
Responsible Party	LG Electronics USA, Inc.
Address	111 Sylvan Avenue, North Building, Englewood Cliffs, NJ 07632
E-mail	lg.environmental@lge.com

LG Customer Information Center

For inquires or comments, visit www.lg.com or call;

1-800-243-0000	USA, Consumer User
1-888-865-3026	USA, Commercial User

Register your product Online!

www.lg.com

Important Safety Instruction

- Read these instructions.
- Keep these instructions.
- Heed all warnings.
- Follow all instructions.
- Do not use this apparatus near water.
- Clean only with dry cloth.
- Do not block any ventilation openings. Install in accordance with the manufacturer's instructions.
- Do not install near any heat sources such as radiators, heat registers, stoves, or other apparatus (including amplifiers) that produce heat.
- Do not defeat the safety purpose of the polarized or grounding-type plug. A polarized plug has two blades with one wider than the other. A grounding type plug has two blades and a third grounding prong. The wide blade or the third prong are provided for your safety. If the provided plug does not fit into your outlet, consult an electrician for replacement of the obsolete outlet.
- Protect the power cord from being walked on or pinched particularly at plugs, convenience receptacles, and the point where they exit from the apparatus.
- Only use attachments/accessories specified by the manufacturer.
- Use only with the cart, stand, tripod, bracket, or table specified by the manufacturer, or sold with the apparatus. When a cart is used, use caution when moving the cart/apparatus combination to avoid injury from tip-over.



- Unplug this apparatus during lightning storms or when unused for long periods of time.
- Refer all servicing to qualified service personnel. Servicing is required when the apparatus has been damaged in any way, such as power-supply cord or plug is damaged, liquid has been spilled or objects have fallen into the apparatus, the apparatus has been exposed to rain or moisture, does not operate normally, or has been dropped.

Before reading this manual

- Read this manual thoroughly before operating your TV, and keep it for future reference.
- On the website you can download the manual including installation, use, troubleshooting, specifications, license etc and view its contents on your PC or mobile device.
- **User Guide** : For more information about this TV, read the USER GUIDE embedded in the product. (Depending upon model)
 -  : This icon indicates that application may depend upon model in Quick Setup Guide.

Optional Extras

- Optional extras can be changed or modified for quality improvement without any notification. Contact your dealer for buying these items. These devices work only with certain models.
- The model name or design may be changed due to the manufacturer's circumstances or policies.
- Magic Motion Remote Control :
Check whether your TV model supports Bluetooth in the Wireless Module Specification to verify whether it can be used with the Magic Motion Remote Control.
- A cable to connect antennas and external devices must be purchased separately.

Note

- Product specifications or contents of this manual may be changed without prior notice due to upgrade of product functions.
- The items supplied with your product may vary depending upon the model.
- Image shown may differ from your TV.

Warning! Safety instructions



CAUTION: TO REDUCE THE RISK OF ELECTRIC SHOCK DO NOT REMOVE COVER (OR BACK). NO USER SERVICEABLE PARTS INSIDE. REFER TO QUALIFIED SERVICE PERSONNEL.



The symbol is intended to alert the user to the presence of uninsulated dangerous voltage within the product's enclosure that may be of sufficient magnitude to constitute a risk of electric shock to persons.



The symbol is intended to alert the user to the presence of important operating and maintenance (servicing) instructions in the literature accompanying this apparatus.

WARNING: TO REDUCE THE RISK OF FIRE AND ELECTRIC SHOCK, DO NOT EXPOSE THIS PRODUCT TO RAIN OR MOISTURE.

- TO PREVENT THE SPREAD OF FIRE, KEEP CANDLES OR OTHER ITEMS WITH OPEN FLAMES AWAY FROM THIS PRODUCT AT ALL TIMES.
- **Do not place the TV and/or remote control in the following environments:**
 - Keep the product away from direct sunlight.
 - An area with high humidity such as a bathroom.
 - Near any heat source such as stoves and other devices that produce heat.
 - Near kitchen counters or humidifiers where they can easily be exposed to steam or oil.
 - An area exposed to rain or wind.
 - Do not expose to dripping or splashing and do not place objects filled with liquids, such as vases, cups, etc. on or over the apparatus (e.g., on shelves above the unit).
 - Near flammable objects such as gasoline or candles, or expose the TV to direct air conditioning.
 - Do not install in excessively dusty places.Otherwise, this may result in fire, electric shock, combustion/explosion, malfunction or product deformation.
- **Ventilation**
 - Install your TV where there is proper ventilation. Do not install in a confined space such as a bookcase.
 - Do not install the product on a carpet or cushion.
 - Do not block or cover the product with cloth or other materials while unit is plugged in.
- Take care not to touch the ventilation openings. When watching the TV for a long period, the ventilation openings may become hot.
- Protect the power cord from physical or mechanical abuse, such as being twisted, kinked, pinched, closed in a door, or walked upon. Pay particular attention to plugs, wall outlets, and the point where the cord exits the device.
- Do not move the TV while the Power cord is plugged in.
- Do not use a damaged or loosely fitting power cord.
- Be sure to grasp the plug when unplugging the power cord. Do not pull on the power cord to unplug the TV.
- Do not connect too many devices to the same AC power outlet as this could result in fire or electric shock.
- **Disconnecting the Device from the Main Power**
 - The power plug is the disconnecting device. In case of an emergency, the power plug must remain readily accessible.
- Do not let your children climb or cling onto the TV. Otherwise, the TV may fall over, which may cause serious injury.
- **Outdoor Antenna Grounding** (Can differ by country):
 - If an outdoor antenna is installed, follow the precautions below.
An outdoor antenna system should not be located in the vicinity of overhead power lines or other electric light or power circuits, or where it can come in contact with such power lines or circuits as death or serious injury can occur.
Be sure the antenna system is grounded to provide some protection against voltage surges and built-up static charges.
Section 810 of the National Electrical Code (NEC) in the U.S.A. provides information with respect to proper grounding of the mast and supporting structure, grounding of the lead-in wire to an antenna discharge unit, size of grounding conductors, location of antenna discharge unit, connection to grounding electrodes and requirements for the grounding electrode.
Antenna grounding according to the National Electrical Code, ANSI/NFPA 70
- Never touch this apparatus or antenna during a lightning storm. You may be electrocuted.
- Make sure the power cord is connected securely to the TV and wall socket. If not secured, damage to the Plug and socket may occur and in extreme cases a fire may break out.
- Do not insert metallic or inflammable objects into the product. If a foreign object is dropped into the product, unplug the power cord and contact the customer service.
- Do not touch the end of the power cord while it is plugged in. You may be electrocuted.

- **If any of the following occur, unplug the product immediately and contact your local customer service.**

- The product has been damaged.
- If water or another substance enters the product (like an AC adapter, power cord, or TV).
- If you smell smoke or other odors coming from the TV
- When lightning storms or when unused for long periods of time.

Even if the TV is turned off by remote control or button, AC power source is connected to the unit if still unplugged in.

- Do not use high voltage electrical equipment near the TV (e.g., a bug zapper). This may result in product malfunction.
- Do not attempt to modify this product in any way without written authorization from LG Electronics. Accidental fire or electric shock can occur. Contact your local customer service for service or repair. Unauthorized modification could void the user's authority to operate this product.
- Use only authorized attachments / accessories approved by LG Electronics. Otherwise, this may result in fire, electric shock, malfunction, or product damage.
- Never disassemble the AC adapter or power cord. This may result in fire or electric shock.
- Handle the adapter carefully to avoid dropping or striking it. An impact could damage the adapter.
- To reduce the risk of fire or electrical shock, do not touch the TV with wet hands. If the power cord prongs are wet or covered with dust, dry the power plug completely or wipe dust off.

- **Batteries**

- Store the accessories (battery, etc.) in a safe location out of the reach of children.
- Do not short circuit, disassemble, or allow the batteries to overheat. Do not dispose of batteries in a fire. Batteries should not be exposed to excessive heat.
- Caution: Risk of fire or explosion if the battery is replaced by an incorrect type.

- **Moving**

- When moving, make sure the product is turned off, unplugged, and all cables have been removed. It may take 2 or more people to carry larger TVs. Do not press or put stress on the front panel of the TV. Otherwise, this may result in product damage, fire hazard or injury.

- Keep the packing anti-moisture material or vinyl packing out of the reach of children.

- Do not allow an impact shock or any objects to fall into the product, and do not drop anything onto the screen.

- Do not press strongly upon the panel with a hand or a sharp object such as a nail, pencil, or pen, or make a scratch on it. It may cause damage to screen.

- **Cleaning**

- When cleaning, unplug the power cord and wipe gently with a soft/dry cloth. Do not spray water or other liquids directly on the TV. Do not clean your TV with chemicals including glass cleaner, any type of air freshener, insecticide, lubricants, wax (car, industrial), abrasive, thinner, benzene, alcohol etc., which can damage the product and/or its panel. Otherwise, this may result in electric shock or product damage.

Installation

Lifting and moving the TV

When moving or lifting the TV, read the following to prevent the TV from being scratched or damaged and for safe transportation regardless of its type and size.

- It is recommended to move the TV in the box or packing material that the TV originally came in.
- Before moving or lifting the TV, disconnect the power cord and all cables.
- When holding the TV, the screen should face away from you to avoid damage.
- Hold the top and bottom of the TV frame firmly. Make sure not to hold the transparent part, speaker, or speaker grille area.
- Use at least two people to move a large TV.
- When transporting the TV, do not expose the TV to jolts or excessive vibration.
- When transporting the TV, keep the TV upright; never turn the TV on its side or tilt towards the left or right.
- When handling the TV, be careful not to damage the protruding buttons.



- Avoid touching the screen at all times, as this may result in damage to the screen.
- Do not place the product on the floor with its front facing down without padding. Failure to do so may result in damage to the screen.
- When attaching the stand to the TV set, place the screen facing down on a cushioned table or flat surface to protect the screen from scratches.

Mounting on the Table

- 1 Lift and tilt the TV into its upright position on a table.
 - Leave a minimum of 10 cm (4 inches) space from the wall for proper ventilation. (Depending upon model).
- 2 Connect the power cord to a wall outlet.



- Do not apply foreign substances (oils, lubricants, etc.) to the screw parts when assembling the product. (Doing so may damage the product.)
- Do not use any unapproved items to ensure the safety and lifespan of the product.
- Any damages or injuries by using unapproved items are not covered by the warranty.
- If you install the TV on a stand, you need to take actions to prevent the product from overturning. Otherwise, the product may fall over, which may cause injury.
- When assembling the stand, ensure that all of the provided screws are attached. If the screws are not fully tightened, the product may tilt or tip over, resulting in damage. Tightening the screws with excessive force may cause them to come off due to abrasion of the screw joint.



- Remove the stand before installing the TV on a wall mount by performing the stand attachment in reverse.
- For more information of screws and wall mount bracket, refer to manual included in the separately purchased wall mount.
- If you intend to mount the product to a wall, attach VESA standard mounting interface (optional parts) to the back of the product. When you install the set to use the wall mounting bracket (optional parts), fix it carefully so as not to drop.
- When mounting a TV on the wall, make sure not to install the TV by hanging the power and signal cables on the back of the TV.
- Do not install this product on a wall if it could be exposed to oil or oil mist. This may damage the product and cause it to fall.
- When installing the wall mounting bracket, it is recommended to cover the stand hole using tape, in order to prevent the influx of dust and insects, (Depending upon model).

Securing TV to the Wall

- 1 Insert and tighten the eye-bolts or TV brackets and bolts on the back of the TV.
 - If there are bolts inserted at the eye-bolts position, remove the bolts first.
- 2 Mount the wall brackets with the bolts to the wall. Match the location of the wall bracket and the eye-bolts on the rear of the TV.
- 3 Connect the eye-bolts and wall brackets tightly with a sturdy rope or cable. Make sure to keep the rope parallel to the flat surface.
 - Use a platform or cabinet that is strong and large enough to support the TV securely.
 - Brackets, bolts, and ropes are optional. You can obtain additional accessories from your local dealer.

Mounting to the Wall

An optional wall mount can be used with your LG Television. Consult with your local dealer for a wall mount that supports the VESA standard used by your TV model. Carefully attach the wall mount bracket at the rear of the TV. Install the wall mount bracket on a solid wall perpendicular to the floor. If you are attaching the TV to other building materials, please contact qualified personnel to install the wall mount. Detailed instructions will be included with the wall mount. We recommend that you use an LG brand wall mount (Depending upon model). The LG wall mount is easy to adjust or to connect the cables. When you do not use LG's wall mount bracket, use a wall mount bracket where the device is adequately secured to the wall with enough space to allow connectivity to external devices. If you are using a non-adjustable mount, attach the mount to the wall. Attach the cables to the TV first, then attach the TV to the mount.

Antenna/Cable

Connect an antenna, cable, or cable box to watch TV while referring to the following. The illustrations may differ from the actual items and an RF cable is optional.

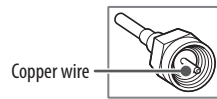

- Make sure not to bend the copper wire of the RF cable.
- Complete all connections between devices, and then connect the power cord to the power outlet to prevent damage to your TV.
- Use a signal splitter to use 2 TVs or more.
- DTV Audio Supported Codec: MPEG, Dolby Digital
- This TV cannot receive Ultra HD (3840 x 2160 pixels) broadcasts directly because the related standards have not been confirmed (Depending upon country).

Starting TV

Turning on the TV

You can simply operate the TV functions, using the button.

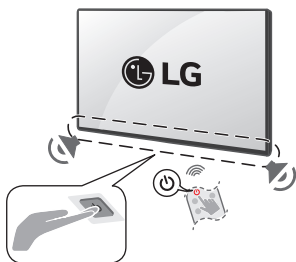

Power On (Press)
Power Off¹⁾ (Press and Hold)
Menu Control (Press²⁾)
Menu Selection (Press and Hold³⁾)

- 1) All running apps will close.
- 2) You can access and adjust the menu by pressing the button when TV is on.
- 3) You can use the function when you access menu control.

✔ Note

- When the TV is turned on for the first time after being shipped from the factory, initialization of the TV may take approximately one minute.
- Your TV's OSD (On Screen Display) may differ slightly from that shown in this manual (Depending upon model).
- The device must be easily accessed to a location outlet near the access. Some devices are not made by turning on / off button, turning off the device and unplugging the power cord (Depending upon model).

Connections

You can connect various external devices to the TV. For more information on external device's connection, refer to the manual provided with each device.

HDMI

- When connecting the HDMI cable, the product and external devices should be turned off and unplugged.

✔ Note

- If the device connected to Input Port also supports HDMI Deep Color, your picture may be clearer. However, if the device doesn't support it, it may not work properly. In that case, change the TV's [HDMI Deep Color] setting to off (Depending upon model).
- Use a certified cable with the HDMI logo attached. If you do not use a certified HDMI cable, the screen may not display or a connection error may occur.
- Recommended HDMI cable types (3 m (9.84 feet) or less)
 - Ultra High Speed HDMI^{®/™} cable

USB

Some USB Hubs may not work. If a USB device connected through a USB Hub is not detected, connect it directly to the USB port on the TV. (Depending upon model)

✔ Note

- For an optimal connection, HDMI cables and USB devices should have bezels less than 10 mm (0.39 inches) thick and 18 mm (0.7 inches) width. (Depending upon model)
- Use an extension cable that supports USB 2.0 if the USB cable or USB flash drive does not fit into your TV's USB port.

IR Blaster

Control the set-top box (cable/satellite/IP/OTT), Blu-ray/DVD player, soundbar, game consoles, etc., using the IR Blaster (Depending upon country) (Depending upon model).

✔ Note

- Connect the IR Blaster cable to the TV's IR Blaster port.
- Use universal control settings to control the device.
- Secure the IR Blaster with the 3M tape provided.
- In order to control external devices through "Hands-free Voice Control", an IR blaster connection is required.

Adapter



- Please be sure to connect the TV to the AC-DC power adapter before connecting the TV's power plug to a wall power outlet. (Depending on model)

External Devices

Supported external devices are: Blu-ray player, HD receivers, DVD players, VCRs, audio systems, USB storage devices, PC, gaming devices, and other external devices. For more information on external device's connection, refer to the manual provided with each device.

✔ Note

- The external device connections shown may differ slightly from illustrations in a manual.
- In PC mode, there may be noise associated with the resolution, vertical pattern, contrast or brightness. If noise is present, change the PC output to another resolution, change the refresh rate to another rate or adjust the brightness and contrast on the [Picture] menu until the picture is clear. Depending upon the graphics card, some resolution settings may not allow the image to be positioned on the screen properly.
- The TV may be capable of operating without a set-top-box from a multichannel video programming distributor (MVPD).

Remote RS-232C setup

To obtain the RS-232C external control setup information, please visit www.lg.com. Download and read the manual, (Depending upon model).



- Do not drop the product or let it fall over when connecting external devices. Otherwise, this may result in injury or damage to the product.
- When connecting external devices such as video game consoles, make sure the connecting cables are long enough. Otherwise, the product may fall over, which may cause injury or damage the product.

Specifications

Product specifications may be changed without prior notice due to upgrade of product functions.

Estimated yearly energy consumption indicated on the FTC label is measured in accordance with the Test Procedures for Television Sets (USA only).

The actual energy consumption depends on the usage environment (The content watched, TV settings, etc.).

- For information of the power supply and power consumption, refer to the label attached to the product.
 - The typical power consumption is measured in accordance with IEC 62087 or each country's energy regulations.
 - * On some models, the label is inside the external device connection terminal cover.
 - * Depending upon the model or country, the typical power consumption may not be on label.

*: 0~9, A~Z

Power requirement	AC 120V ~ 50/60 Hz	
	24/ 27LB70* , 32LB65*	DC 19V ---

(Depending upon country)

Broadcasting Specifications	
Television system	Terrestrial / Cable / Satellites Digital TV
External antenna impedance	75 Ω

AC/DC Adapter		
24/ 27LB70*	Manufacturer: Honor	Input : AC 100-240V ~ 50/60Hz
	Model : ADS-45FSQ-19 19040EPCU-1	Output : DC 19V --- = 2.1A
32LB65*	Manufacturer: Honor	Input : AC 100-240V ~ 50/60Hz
	Model : ADS-48FSK-19 19048EPCU-1	Output : DC 19V --- = 2.53A

Environment Condition			
Operating Temperature	0 °C to 40 °C (32 °F to 104 °F)	Storage Temperature	-20 °C to 60 °C (-4 °F to 140 °F)
Operating Humidity	Less than 80 %	Storage Humidity	Less than 85 %

Conditions for Wall Mount Installation	
Tilt Angle (Depending upon model)	0° - 15°

* This specification range applies to TV wall mounts when adjusting for proper viewing angle.

Open Source Software Notice Information

To obtain the source code that is contained in this product, under GPL, LGPL, MPL, and other open source licenses that have the obligation to disclose source code, and to access all referred license terms, copyright notices, please visit <https://opensource.lge.com>.

LG Electronics will also provide open source code to you for a charge covering the cost of performing such distribution upon email request to opensource@lge.com.

This offer is valid to anyone in receipt of this information for a period of three years after our last shipment of this product.

Licenses



Troubleshooting

In TV / HDMI input, press the  button on the remote control three times to display the model name and serial number on the screen.

For detailed information or videos, visit www.lg.com for the troubleshooting page.

Cannot control the TV with the remote control.	<ul style="list-style-type: none">• Check if anything such as tape has been placed over the receiver.• Check if there is any obstacle between the product and the remote control.• Replace the batteries with new fresh ones.
No image display and no sound is produced.	<ul style="list-style-type: none">• Check if the product is turned on.• Check if the power cord is connected to a wall outlet.• Check if there is a problem in the wall outlet by connecting other products.
The TV turns off suddenly.	<ul style="list-style-type: none">• Check the power control settings. The power supply may be interrupted.• Check if the auto-off function is activated on the settings related time.• The auto-off function may have worked. This product is equipped with an auto-off function that automatically turns off the power if the remote control is not used for 15 minutes without an input signal.
Abnormal Display	<ul style="list-style-type: none">• If the product feels cold to the touch, there may be a small "flicker" when it is turned on. This is normal, there is nothing wrong with product.• This panel is an advanced product that contains millions of pixels. You may see tiny black dots and/or brightly colored dots (red, blue or green) at a size of 1 ppm on the panel. This does not indicate a malfunction and does not affect the performance and reliability of the product. This phenomenon also occurs in third-party products and is not subject to exchange or refund.• You may find different brightness and color of the panel depending upon your viewing position(left/right/top/down). This phenomenon occurs due to the characteristic of the panel. It is not related to the product performance, and it is not malfunction.• Avoid touching the screen or holding your finger(s) against it for long periods of time. Doing so may produce some temporary distortion effects on the screen.• Displaying a still image for a prolonged period of time may cause an image sticking. Avoid displaying a fixed image on the TV screen for an extended length of time.
Generated Sound	<ul style="list-style-type: none">• Cracking noise A cracking noise that occurs when watching or turning off the TV is generated by plastic thermal contraction due to temperature and humidity. This noise is common for products where thermal deformation is required.• Electrical circuit humming/panel buzzing A low level noise is generated from a high-speed switching circuit, which supplies a large amount of current to operate a product. It varies depending upon the product. This generated sound does not affect the performance and reliability of the product.



- When cleaning the product, be careful not to allow any liquid or foreign objects to enter the gap between the upper, left or right side of the panel and the guide panel, (Depending upon model).
- Make sure to wring any excess water or cleaner from the cloth.
- Do not spray water or cleaner directly onto the TV screen.
- Make sure to spray just enough of water or cleaner onto a dry cloth to wipe the screen.

Regulatory

FCC Notice

(For USA)

This equipment has been tested and found to comply with the limits for a Class B digital device, pursuant to Part 15 of the FCC Rules. These limits are designed to provide reasonable protection against harmful interference in a residential installation. This equipment generates, uses, and can radiate radio frequency energy and, if not installed and used in accordance with the instructions, may cause harmful interference to radio communications. However, there is no guarantee that interference will not occur in a particular installation. If this equipment does cause harmful interference to radio or television reception, which can be determined by turning the equipment off and on, the user is encouraged to try to correct the interference by one or more of the following measures:

- Reorient or relocate the receiving antenna.
- Increase the separation between the equipment and the receiver.
- Connect the equipment to an outlet on a circuit different from that to which the receiver is connected.
- Consult the dealer or an experienced radio/TV technician for help.

This device complies with part 15 of the FCC Rules. Operation is subject to the following two conditions: (1) this device may not cause harmful interference and (2) this device must accept any interference received, including interference that may cause undesired operation. Any changes or modifications in construction of this device which are not expressly approved by the party responsible for compliance could void the user's authority to operate the equipment. And For indoor use only, use outdoors or in other modes not covered by this manual may violate the FCC regulation and violate the user authority to use the product.

FCC Radio Frequency Interference Requirements (for UNII devices)

(For USA)

High power radars are allocated as primary users of the 5.25 to 5.35 GHz and 5.65 to 5.85 GHz bands. These radar stations can cause interference with and/or damage this device. This device cannot be co-located with any other transmitter.

Transmitters in the 5.925-7.125 GHz band are prohibited from operating to control or communicate with unmanned aircraft systems.

FCC RF Radiation Exposure Statement

(For USA)

[For having wireless function (WLAN, Bluetooth,...)]

This equipment complies with FCC radiation exposure limits set forth for an uncontrolled environment. This transmitter must not be co-located or operating in conjunction with any other antenna or transmitter. This equipment should be installed and operated with minimum distance 20 cm (7.8 inches) between the antenna and your body. Users must follow the specific operating instructions for satisfying RF exposure compliance.

(Device for using 5925 - 7125 MHz)

- 1) FCC regulations restrict the operation of this device to indoor use only.
- 2) The operation of this device is prohibited on oil platforms, cars, trains, boats, and aircraft, except that operation of this device is permitted in large aircraft while flying above 10,000 feet in the 5.925-6.425 GHz band.
- 3) Operation of transmitters in the 5.925-7.125 GHz band is prohibited for control of or communications with unmanned aircraft systems.

NOTE TO CABLE/TV INSTALLER

(For USA)

This reminder is provided to call the CATV system installer's attention to Article 820-40 of the National Electric Code (U.S.A.). The code provides guidelines for proper grounding and, in particular, specifies that the cable ground shall be connected to the grounding system of the building, as close to the point of the cable entry as practical.

LG Take-back & Recycling Policy

(For USA)

LG Electronics offers a customized e-waste take-back & recycling service that meets local needs and requirements in the countries where e-waste regulations are in place, and also provides product take-back & recycling service voluntarily in some regions. LG Electronics evaluates products' recyclability at the design step selectively, with the goal of improving recyclability where practicable. Through these activities, LG Electronics seeks to contribute to conserving natural resources and protecting the environment. For more information, please visit our global site at

<https://www.lg.com/recycling>

WARNING! (STABILITY HAZARD)

A television set may fall, causing serious personal injury or death. Many injuries, particularly to children, can be avoided by taking simple precautions such as:

- ALWAYS use cabinets or stands or mounting methods recommended by the manufacturer of the television set.
- ALWAYS use furniture that can safely support the television set.
- ALWAYS ensure the television set is not overhanging the edge of the supporting furniture.
- ALWAYS educate children about the dangers of climbing on furniture to reach the television set or its controls.
- ALWAYS route cords and cables connected to your television so they cannot be tripped over, pulled or grabbed.
- NEVER place a television set in an unstable location.
- NEVER place the television set on tall furniture (for example, cupboards or bookcases) without anchoring both the furniture and the television set to a suitable support.
- NEVER place the television set on cloth or other materials that may be located between the television set and supporting furniture.
- NEVER place items that might tempt children to climb, such as toys and remote controls, on the top of the television or furniture on which the television is placed.













If the existing television set is going to be retained and relocated, the same considerations as above should be applied.

Symbols

	Refers to alternating current (AC).		Refers to stand-by.
	Refers to direct current (DC).		Refers to "ON" (power).
	Refers to class II equipment.		Refers to dangerous voltage.

Using Magic Motion Remote Control







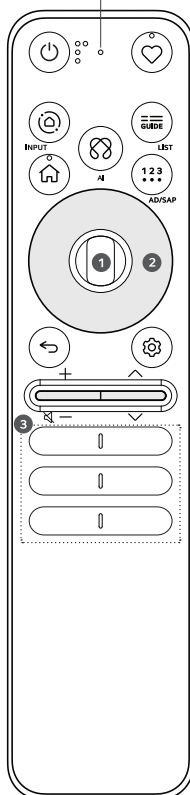

Short press Basic Guide

	Power: Turns the TV On or Off.
	Select Custom Menu / Accessibility .
	Displays the Home Hub .
	Accesses the TV Guide .
	Check for recommended content. (Some recommended services may not be available in some countries.)
	Displays the Home Menu .
	Displays more remote control functions.
	Press to select menu and operate device. (play/pause, etc.) Scroll up and down Scrolls the screen or change channels.
	Up, Down, Left, Right Navigation buttons.
	Move to the Previous Step .
	Displays the Quick Settings Menu .
	Various content service buttons.

Microphone



Long press Extension Guide

	Accesses the Accessibility Shortcuts .
	Changes the Input Source .
	Accesses the saved Channels List .
	Speak to the remote control while pressing and holding the button to use the Voice Recognition feature.
	To enable the Screen Zoom .
	Enables SAP (Second Audio Program) Feature.
	The screen displayed on the TV is closed and the Home Menu appears.
	Displays the All Settings Menu .

+ / - Push up and down to **Adjust the Volume**.

^ / v Push up and down to **Change Channels**.

 — Push down long press to **Mute**.

✓ Note

- The terms in this manual are used in general terms to help users understand and may not match the terms displayed on the screen.

The descriptions in this manual are based on the buttons on the remote control. Please read this manual carefully and use the TV correctly. This remote uses infrared light. When in use, it should be pointed in the direction of the TV's remote sensor.
(Some buttons and services may not be provided depending upon models or regions.)

How to register the Magic Motion Remote Control

To use the Magic Motion Remote Control, first pair it with your TV.

- 1 Put batteries into the Magic Motion Remote Control and turn the TV on.
- 2 Point the Magic Motion Remote Control at your TV and press the  **Wheel (OK)** on the remote control.

* If the TV fails to register the Magic Motion Remote Control, try again after turning the TV off and back on.

How to deregister the Magic Motion Remote Control

Press the  **(Back)** and  **(Home)** buttons at the same time, for five seconds, to unpair the Magic Motion Remote Control with your TV.

* Press and hold the  **(Home)** and  **(Q. Settings)** buttons for more than 5 seconds to disconnect and re-register the Magic Motion Remote Control at the same time.









- It is recommended that an Access Point (AP) be located more than 0.2 m (0.65 ft) away from the TV. If the AP is installed closer than 0.2 m (0.65 ft), the Magic Motion Remote Control may not perform as expected due to frequency interference.

Using Always Ready

(Depending upon model)

You can operate the TV and connect to Bluetooth with direct voice recognition while the power is off.

- * Pressing the  **(Power)** button while watching TV switches the screen to [Always Ready] that is turned on, and pressing the  **(Power)** button once more turns the screen to [Always Ready] that is turned off.
- * Press the  **(Home)** button or the  **(Back)** button to watch TV when the screen is in [Always Ready] that is turned on.
- * Press the  **Wheel (OK)** button to display the wallpaper when the screen is in [Always Ready] that is turned off, and press the  **(Power)** button to watch TV.

Note

- Using Always Ready may increase energy consumption.

Using Remote Control

Short press Basic Guide

	Power: Turns the TV on or off.
	Changes the Input Source .
	Displays the Home Hub .
	Recalls your preferred Subtitle in digital mode.
	Enables SAP (Second Audio Program) Feature.
	Displays the Quick Settings Menu .
	Inserts a — between numbers such as 2-1 and 2-2.
	Displays the channel event according to time scheduler.
	Displays more remote control functions.
	Mutes all sounds.
	Search: Check recommended content (Depending upon country) and run search mode.
	You can watch TV Channels .
	Various content service buttons.
	Displays the Home Menu .
	Scrolls through menus or options.
	Move to the Previous Step .
	Closes the current app and goes to the Home Menu .
	Accesses the saved Channels List .
	Shows User Guide .
	Control buttons for media contents.
	These access special functions in some menus.

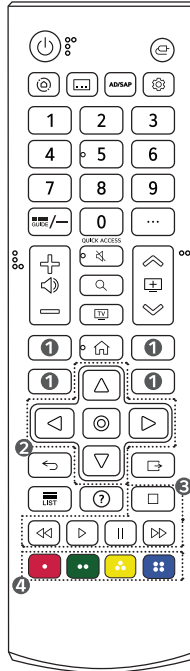

Adjusts the **Volume Level**.

Scrolls through the saved **Channels**.

Long press Extension Guide

	Displays the Home Hub .
	Changes the Input Source .
	Displays the All Settings Menu .
	Accesses the Quick Help .
	Accesses the Edit Quick Access .
	Accesses the saved Channels List .
	Enables SAP (Second Audio Program) Feature.
	Accesses the Accessibility Shortcuts .
	To enable the Screen Zoom .
	Closes the current app and goes to the Home Menu .
	Accesses the TV Guide .
	Runs the record function.

✓ Note

- The terms in this manual are used in general terms to help users understand and may not match the displayed term icons on the screen.
- The descriptions in this manual are based on the buttons on the remote control. Please read this manual carefully and use the TV correctly. (Some buttons and services may not be provided depending upon models or regions.)



OWNER'S MANUAL

EXTERNAL CONTROL DEVICE SETUP

Please read this manual carefully before operating the set and retain it for future reference.

www.lg.com

P/NO : MFL71445401 (1901-REV00)

KEY CODES

- This feature is not available for all models.

Code (Hexa)	Function	Note	Code (Hexa)	Function	Note
00	CH +, PR +	R/C Button	53	List	R/C Button
01	CH -, PR -	R/C Button	5B	Exit	R/C Button
02	Volume +	R/C Button	60	PIP(AD)	R/C Button
03	Volume -	R/C Button	61	Blue	R/C Button
06	> (Arrow Key / Right Key)	R/C Button	63	Yellow	R/C Button
07	< (Arrow Key / Left Key)	R/C Button	71	Green	R/C Button
08	Power	R/C Button	72	Red	R/C Button
09	Mute	R/C Button	79	Ratio / Aspect Ratio	R/C Button
0B	Input	R/C Button	91	AD (Audio Description)	R/C Button
0E	SLEEP	R/C Button	9E	LIVE MENU	R/C Button
0F	TV, TV/RAD	R/C Button	7A	User Guide	R/C Button
10 - 19	* Number Key 0 - 9	R/C Button	7C	Smart / Home	R/C Button
1A	Q.View / Flashback	R/C Button	7E	SIMPLINK	R/C Button
1E	FAV (Favorite Channel)	R/C Button	8E	▶▶ (Forward)	R/C Button
20	Text (Teletext)	R/C Button	8F	◀◀ (Rewind)	R/C Button
21	T. Opt (Teletext Option)	R/C Button	AA	Info	R/C Button
28	Return (BACK)	R/C Button	AB	Program Guide	R/C Button
30	AV (Audio / Video) Mode	R/C Button	B0	▶ (Play)	R/C Button
39	Caption/Subtitle	R/C Button	B1	■ (Stop / File List)	R/C Button
40	∧ (Arrow Key / Cursor Up)	R/C Button	B5	RECENT	R/C Button
41	∨ (Arrow Key / Cursor Down)	R/C Button	BA	(Freeze / Slow Play / Pause)	R/C Button
42	My Apps	R/C Button	BB	Soccer	R/C Button
43	Menu / Settings	R/C Button	BD	● (REC)	R/C Button
44	OK / Enter	R/C Button	DC	3D	R/C Button
45	Q.Menu	R/C Button	99	AutoConfig	R/C Button
4C	List, -	R/C Button	9F	App / *	R/C Button
4D	PICTURE	R/C Button	9B	TV / PC	R/C Button
52	SOUND	R/C Button			

* Key code 4C (0x4C) is available on ATSC/ISDB models which use major/minor channel.
(For South Korea, Japan, North America, Latin America except Colombia models)

EXTERNAL CONTROL DEVICE SETUP

- Image shown may differ from your TV.

Connect the USB to Serial(RS-232C) converter/RS-232C(Serial) input jack to an external control device (such as a computer or an A/V control system) to control the product's functions externally.

Note: The type of control port on the TV can be different between model series.

- * Please be advised that not all models support this type of connectivity.
- * Cable is not provided.

USB to Serial(RS-232C) converter with USB Cable

USB Type

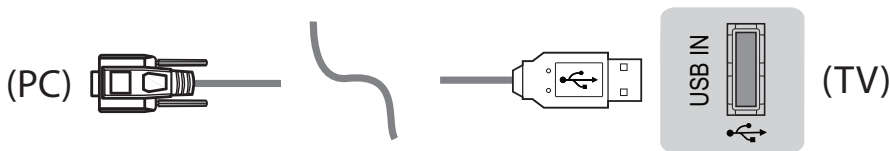

- LGTV supports PL2303 chip-based (Vendor ID : 0x0557, Product ID : 0x2008) USB to serial(RS-232C) converter which is not made nor provided by LG.
- It can be purchased from computer stores that carry accessories for IT support professionals.

RS-232C(Serial) With RS-232C(Serial) Cable

DE9 (D-Sub 9pin) Type

- You need to purchase the RS-232C (DE9, D-Sub 9pin female-to-female type) to RS-232C(Serial) cable required for the connection between the PC and the TV, which is specified in the manual.



The connection interface may differ from your TV.

Phone jack Type

- You need to purchase the phone-jack to RS-232 cable required for the connection between the PC and the TV, which is specified in the manual.
- * For other models, connect to the USB port.
- * The connection interface may differ from your TV.

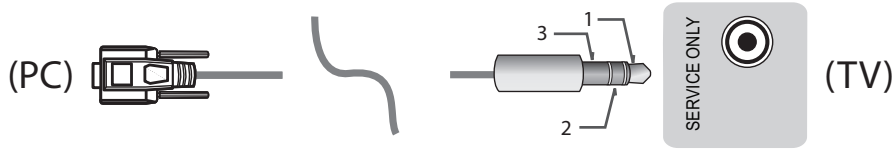

- or -

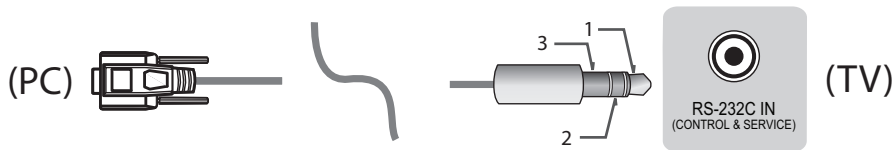

Customer Computer

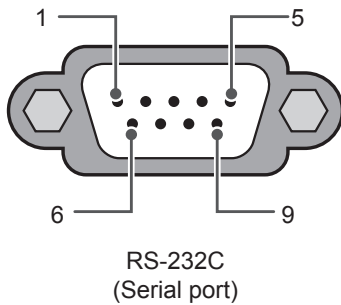

RS-232C configurations

3-Wire Configurations(Not standard)

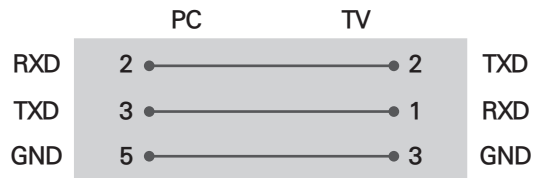

OR

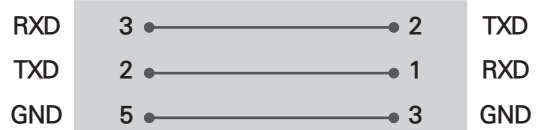

D-Sub 9

Phone

Set ID

For Set ID number, see "Real Data Mapping" on p.6

1. Press **SETTINGS** to access the main menus.
2. Press the Navigation buttons to scroll to (***General** → **About this TV or OPTION**) and press **OK**.
3. Press the Navigation buttons to scroll to **SET ID** and press **OK**.
4. Scroll left or right to select a set ID number and select **CLOSE**. The adjustment range is 1-99.
5. When you are finished, press **EXIT**.
* (Depending on model)

Communication Parameters

- Baud rate : 9600 bps (UART)
- Data length : 8 bits
- Parity : None
- Stop bit : 1 bit
- Communication code : ASCII code
- Use a crossed (reverse) cable.

Command reference list

(Depending on model)

	COMMAND1	COMMAND2	DATA (Hexadecimal)		COMMAND1	COMMAND2	DATA (Hexadecimal)
01. Power*	k	a	00 to 01	15. Balance	k	t	00 to 64
02. Aspect Ratio	k	c	(p.7)	16. Color (Colour) Temperature	x	u	00 to 64
03. Screen Mute	k	d	(p.7)	17. ISM Method (Only Plasma TV)	j	p	(p.8)
04. Volume Mute	k	e	00 to 01	18. Equalizer	j	v	(p.9)
05. Volume Control	k	f	00 to 64	19. Energy Saving	j	q	00 to 05
06. Contrast	k	g	00 to 64	20. Tune Command	m	a	(p.9)
07. Brightness	k	h	00 to 64	21. Channel (Programme) Add/Del(Skip)	m	b	00 to 01
08. Color/ Colour	k	i	00 to 64	22. Key	m	c	Key Codes
09. Tint	k	j	00 to 64	23. Control Backlight, Control Panel Light	m	g	00 to 64
10. Sharpness	k	k	00 to 32	24. Input select (Main)	x	b	(p.11)
11. OSD Select	k	l	00 to 01	25. 3D (Only 3D models)	x	t	(p.11)
12. Remote Control Lock Mode	k	m	00 to 01	26. Extended 3D (Only 3D models)	x	v	(p.12)
13. Treble	k	r	00 to 64	27. Auto Configure	j	u	(p.12)
14. Bass	k	s	00 to 64				

* Note: During playing or recording media, all commands except Power (ka) and Key (mc) are not executed and treated as NG.

With RS232C cable, TV can communicate "ka command" in power-on or power-off status. but with USB-to-Serial converter cable, the command works only if TV is on.

Transmission / Receiving Protocol

Transmission

[Command1][Command2][][Set ID][][Data][Cr]

[Command 1] : First command to control the TV. (j, k, m or x)

[Command 2] : Second command to control the TV.

[Set ID] : You can adjust the [Set ID] to choose desired monitor ID number in option menu. Adjustment range in TV is 1 to 99. If [Set ID] value is selected to '0', every connected set can be controlled.
* [Set ID] is indicated as decimal (1 to 99) on menu and as Hexadecimal (0x00 to 0x63) on transmission/receiving protocol.

[DATA] : To transmit command data (hexadecimal). Transmit 'FF' data to read status of command.

[Cr] : Carriage Return - ASCII code '0x0D'

[] : Space - ASCII code '0x20'

OK Acknowledgement

[Command2][][Set ID][][OK][Data][x]

* The set transmits ACK (acknowledgement) based on this format when receiving normal data. At this time, if the data is data read mode, it indicates present status data. If the data is data write mode, it returns the data of the PC computer.

Error Acknowledgement

[Command2][][Set ID][][NG][Data][x]

* The set transmits ACK (acknowledgement) based on this format when receiving abnormal data from non-viable functions or communication errors.

Data 00: Illegal Code

Real data mapping (Hexadecimal to Decimal)

* When you enter the [data] in hexadecimal, refer to following conversion table.

* Channel Tune (ma) Command uses two-byte hexadecimal value([data]) to select channel number.

00 : Step 0	32 : Step 50 (Set ID 50)	FE : Step 254
01 : Step 1 (Set ID 1)	33 : Step 51 (Set ID 51)	FF : Step 255
...
0A : Step 10 (Set ID 10)	63 : Step 99 (Set ID 99)	01 00 : Step 256
...
0F : Step 15 (Set ID 15)	C7 : Step 199	27 0E : Step 9998
10 : Step 16 (Set ID 16)	C8 : Step 200	27 0F : Step 9999
...

* Commands may work differently depending on model and signal.

01. Power (Command: k a)

- ▶ To control Power *On or Off of the set.

Transmission [k][a][][Set ID][][Data][Cr]

Data 00 : Power Off 01 : *Power On

Ack [a][][Set ID][][OK/NG][Data][x]

- ▶ To Show TV is Power On or *Off

Transmission [k][a][][Set ID][][FF][Cr]

Ack [a][][Set ID][][OK][Data][x]

* Similarly, if other functions transmit 'FF' data based on this format, Acknowledgement feedback presents status about each function.

02. Aspect Ratio (Command: k c)

(Main Picture Size)

- ▶ To adjust the screen format. (Main picture format)
You can also adjust the screen format using the Aspect Ratio in the Q.MENU. or PICTURE menu.

Transmission [k][c][][Set ID][][Data][Cr]

Data 01 : Normal screen (4:3)	07 : 14:9 (Europe, Colombia, Mid-East,
02 : Wide screen (16:9)	Asia except South Korea and Japan)
04 : Zoom	09 : * Just Scan
05 : Zoom 2 (Latin America	0B : Full Wide (Europe, Colombia, Mid-
except Colombia Only)	East, Asia except South Korea and Japan)
06 : Set by Program/ Original	10 to 1F : Cinema Zoom 1 to 16 0c : 21:9 (Depending on model)

Ack [c][][Set ID][][OK/NG][Data][x]

- * Using the PC input, you select either 16:9 or 4:3 screen aspect ratio.
- * In DTV/HDMI/Component mode (high-definition), Just Scan is available.
- * Full wide mode may work differently based on model and is supported for DTV fully, and ATV, AV partially.

03. Screen Mute (Command: k d)

- ▶ To select screen mute on/off.

Transmission [k][d][][Set ID][][Data][Cr]

Data 00 : Screen mute off (Picture on)
Video mute off
01 : Screen mute on (Picture off)
10 : Video mute on

Ack [d][][Set ID][][OK/NG][Data][x]

* In case of video mute on only, TV will display On Screen Display(OSD). But, in case of Screen mute on, TV will not display OSD.

04. Volume Mute (Command: k e)

- ▶ To control volume mute on/off.
You can also adjust mute using the MUTE button on remote control.

Transmission [k][e][][Set ID][][Data][Cr]

Data 00 : Volume mute on (Volume off)
01 : Volume mute off (Volume on)

Ack [e][][Set ID][][OK/NG][Data][x]

05. Volume Control (Command: k f)

- ▶ To adjust volume.
You can also adjust volume with the volume buttons on remote control.

Transmission [k][f][][Set ID][][Data][Cr]

Data Min : 00 to Max : 64

Ack [f][][Set ID][][OK/NG][Data][x]

06. Contrast (Command: k g)

- ▶ To adjust screen contrast.
You can also adjust contrast in the PICTURE menu.

Transmission [k][g][][Set ID][][Data][Cr]

Data Min : 00 to Max : 64

Ack [g][][Set ID][][OK/NG][Data][x]

07. Brightness (Command: k h)

- ▶ To adjust screen brightness.
You can also adjust brightness in the PICTURE menu.

Transmission [k][h][][Set ID][][Data][Cr]

Data Min : 00 to Max : 64

Ack [h][][Set ID][][OK/NG][Data][x]

08. Color/Colour (Command: k i)

- ▶ To adjust the screen Color(Colour).
You can also adjust colour in the PICTURE menu.

Transmission [k][i][][Set ID][][Data][Cr]

Data Min : 00 to Max : 64

Ack [i][][Set ID][][OK/NG][Data][x]

09. Tint (Command: k j)

- ▶ To adjust the screen tint.
You can also adjust tint in the PICTURE menu.

Transmission [k][j][][Set ID][][Data][Cr]

Data Red : 00 to Green : 64

Ack [j][][Set ID][][OK/NG][Data][x]

10. Sharpness (Command: k k)

- ▶ To adjust the screen sharpness.
You can also adjust sharpness in the PICTURE menu.

Transmission [k][k][][Set ID][][Data][Cr]

Data Min : 00 to Max : 32

Ack [k][][Set ID][][OK/NG][Data][x]

11. OSD Select (Command: k l)

- ▶ To select OSD (On Screen Display) on/off when controlling remotely.

Transmission [k][l][][Set ID][][Data][Cr]

Data 00 : OSD off 01 : OSD on

Ack [l][][Set ID][][OK/NG][Data][x]

12. Remote control lock mode (Command: k m)

- ▶ To lock the front panel controls on the monitor and remote control.

Transmission [k][m][][Set ID][][Data][Cr]

Data 00 : Lock off 01 : Lock on

Ack [m][][Set ID][][OK/NG][Data][x]

- * If you are not using the remote control, use this mode.
When main power is off & on (plug-off and plug-in, after 20 - 30 seconds), external control lock is released.

- * In the standby mode (DC off by off timer or 'ka', 'mc' command), and if key lock is on, TV will not turn on by power on key of IR & Local Key.

13. Treble (Command: k r)

- ▶ To adjust treble.
You can also adjust in the AUDIO menu.

Transmission [k][r][][Set ID][][Data][Cr]

Data Min : 00 to Max : 64

Ack [r][][Set ID][][OK/NG][Data][x]

* (Depending on model)

14. Bass (Command: k s)

- ▶ To adjust Bass.
You can also adjust in the AUDIO menu.

Transmission [k][s][][Set ID][][Data][Cr]

Data Min : 00 to Max : 64

Ack [s][][Set ID][][OK/NG][Data][x]

* (Depending on model)

15. Balance (Command: k t)

- ▶ To adjust balance.
You can also adjust balance in the AUDIO menu.

Transmission [k][t][][Set ID][][Data][Cr]

Data Min : 00 to Max : 64

Ack [t][][Set ID][][OK/NG][Data][x]

16. Color(Colour) Temperature (Command: x u)

- ▶ To adjust colour temperature. You can also adjust Color(Colour) Temperature in the PICTURE menu.

Transmission [x][u][][Set ID][][Data][Cr]

Data Min : 00 to Max : 64

Ack [u][][Set ID][][OK/NG][Data][x]

17. ISM Method (Command: j p) (Only Plasma TV)

- ▶ To control the ISM method. You can also adjust ISM Method in OPTION menu.

Transmission [j][p][][Set ID][][Data][Cr]

Data Min : 02: Orbiter

08: Normal

20: Color(Colour) Wash

Ack [p][][Set ID][][OK/NG][Data][x]

18. Equalizer (Command : j v)

- ▶ Adjust EQ of the set.

Transmission [j][v][][Set ID][][Data][Cr]

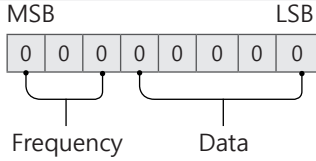

7	6	5	Frequency	4	3	2	1	0	Step
0	0	0	1st Band	0	0	0	0	0	0(decimal)
0	0	1	2nd Band	0	0	0	0	1	1(decimal)
0	1	0	3rd Band
0	1	1	4th Band	1	0	0	1	1	19(decimal)
1	0	0	5th Band	1	0	1	0	1	20(decimal)

Acknowledgement [v][][Set ID][][OK/NG][Data][x]

- * It depends on model, and can adjust when sound mode is EQ adjustable value.

19. Energy Saving (Command: j q)

- ▶ To reduce the power consumption of the TV. You can also adjust Energy Saving in PICTURE menu.

Transmission [j][q][][Set ID][][Data][Cr]

Data

- 00 : Off
- 01 : Minimum
- 02 : Medium
- 03 : Maximum
- 04 : Auto (For LCD TV / LED TV) / Intelligent sensor (For PDP TV)
- 05 : Screen off

- * (Depending on model)

Ack [q][][Set ID][][OK/NG][Data][x]

20. Tune Command (Command: m a)

- * This command may work differently depending on model and signal.

- For Europe, Mid-East, Colombia, Asia except South Korea and Japan Model

- ▶ Select channel to following physical number.

Transmission [m][a][][Set ID][][Data 00][]

[Data 01][][Data 02][Cr]

- * Analog Antenna/Cable

[Data 00][Data 01] Channel Data

Data 00 : High byte channel data

Data 01 : Low byte channel data

- 00 00 ~ 00 C7 (Decimal : 0 ~ 199)

Data 02 : Input Source (Analog)

- 00 : Antenna TV (ATV)

- 80 : Cable TV (CATV)

- * Digital Antenna/Cable/Satellite

[Data 00][Data 01]: Channel Data

Data 00 : High Channel data

Data 01 : Low Channel data

- 00 00 ~ 27 0F (Decimal: 0 ~ 9999)

Data 02 : Input Source (Digital)

- 10 : Antenna TV (DTV)

- 20 : Antenna Radio (Radio)

- 40 : Satellite TV (SDTV)

- 50 : Satellite Radio (S-Radio)

- 90 : Cable TV (CADTV)

- a0 : Cable Radio (CA-Radio)

- * Tune Command Examples:

1. Tune to the Analog antenna (PAL) Channel 10.

Set ID = All = 00

Data 00 & 01 = Channel Data is 10 = 00 0a

Data 02 = Analog Antenna TV = 00

Result = **ma 00 00 0a 00**

2. Tune to the digital antenna (DVB-T) Channel 01.

Set ID = All = 00

Data 00 & 01 = Channel Data is 1 = 00 01

Data 02 = Digital Antenna TV = 10

Result = **ma 00 00 01 10**

3. Tune to the satellite (DVB-S) Channel 1000.

Set ID = All = 00

Data 00 & 01 = Channel Data is 1000 = 03 E8

Data 02 = Digital Satellite TV = 40

Result = **ma 00 03 E8 40**

Ack [a][][Set ID][][OK][Data 00][Data 01]

[Data 02][x][a][][Set ID][][NG][Data 00][x]

- For South Korea, North/Latin America except Colombia Model

- ▶ To tune channel to following physical/major/minor number.

Transmission [m][a][][0][][Data00][][Data01]

[][Data02][][Data03][][Data04][][Data05][Cr]

Digital channels have a Physical, Major, and Minor channel number. The Physical number is the actual digital channel number, the Major is the number that the channel should be mapped to, and the Minor is the sub-channel. Since the ATSC tuner automatically maps the channel from the Major / Minor number, the Physical number is not required when sending a command in Digital.

* Analog Antenna/Cable

Data 00 : Physical Channel Number

- Antenna (ATV) : 02~45 (Decimal: 2 ~ 69)
- Cable (CATV) : 01, 0E~7D (Decimal : 1, 14~125)

[Data 01 ~ 04]: Major/Minor Channel Number

Data 01 & 02: xx (Don't care)

Data 03 & 04: xx (Don't care)

Data 05: Input Source (Analog)

- 00 : Antenna TV (ATV)
- 01 : Cable TV (CATV)

* Digital Antenna/Cable

Data 00 : xx (Don't care)

[Data 01][Data 02]: Major Channel Number

Data 01 : High byte Channel Data

Data 02 : Low byte Channel Data

- 00 01 ~ 27 0F (Decimal: 1 ~ 9999)

[Data 03][Data 04]: Minor Channel Number

Data 03 : High byte Channel Data

Data 04 : Low byte Channel Data

Data 05 : Input Source (Digital)

- 02 : Antenna TV (DTV) – Use Physical Channel Number
- 06 : Cable TV (CADTV) – Use Physical Channel Number
- 22 : Antenna TV (DTV) – Don't Use Physical Channel Number
- 26 : Cable TV (CADTV) - Don't Use Physical Channel Number
- 46 : Cable TV (CADTV) – Use Physical/Major Channel Number Only (One Part Channel)
- 66 : Cable TV (CADTV) – Use Major Channel Number Only (One Part Channel)
- 0b : Cable DTV Plus – Use Physical Channel Number
- 2b : Cable DTV Plus – Don't Use Physical Channel Number
- 4b : Cable DTV Plus – Use Physical/Major Channel Number Only (One Part Channel)
- 6b : Cable DTV Plus – Use Major Channel Number Only (One Part Channel)

Two bytes are available for each major and minor channel data, but usually the low byte is used alone (high byte is 0).

* Tune Command Examples:

1. Tune to the Analog cable (NTSC) channel 35.

Set ID = All = 00
 Data 00 = Channel Data is 35 = 23
 Data 01 & 02 = No Major = 00 00
 Data 03 & 04 = No Minor = 00 00
 Data 05 = Analog Cable TV = 01
 Total = **ma 00 23 00 00 00 01**

2. Tune to the digital antenna (ATSC) channel 30-3.

Set ID = All = 00

Data 00 = Don't know Physical = 00

Data 01 & 02 = Major is 30 = 00 1E

Data 03 & 04 = Minor is 3 = 00 03

Data 05 = Digital Antenna TV = 22

Total = **ma 00 00 00 1E 00 03 22**

Ack [a][][Set ID][][OK][Data 00][Data 01]

[Data 02][Data 03][Data 04][Data 05]

[x][a][][Set ID][][NG][Data 00][x]

• For Japan Model

- ▶ To tune channel to following physical/major/minor number.

Transmission [m][a][][0][][Data00][][Data01]

[][Data02][][Data03][][Data04][][Data05][Cr]

* Digital Antenna/Satellite

Data 00: xx (Don't care)

[Data 01][Data 02]: Major Channel Number

Data 01: High byte Channel Data

Data 02: Low byte Channel Data

- 00 01 ~ 27 0F (Decimal: 1 ~ 9999)

[Data 03][Data 04]: Minor/Branch Channel Number
 (Don't care in Satellite)

Data 03: High byte Channel Data

Data 04: Low byte Channel Data

Data 05 : Input Source (Digital/Satellite for Japan)

- 02 : Antenna TV (DTV)
- 42 : Antenna TV (DTV) – Use Physical/Major Channel Number Only (One Part Channel)
- 62 : Antenna TV (DTV) – Use Major Channel Number Only (One Part Channel)
- 07 : BS (Broadcasting Satellite)
- 08 : CS1 (Communication Satellite 1)
- 09 : CS2 (Communication Satellite 2)

* Tune Command Examples:

1. Tune to the digital antenna (ISDB-T) channel 17-1.

Set ID = All = 00

Data 00 = Don't know Physical = 00

Data 01 & 02 = Major is 17 = 00 11

Data 03 & 04 = Minor/Branch is 1 = 00 01

Data 05 = Digital Antenna TV = 02

Total = **ma 00 00 00 11 00 01 02**

2. Tune to the BS (ISDB-BS) channel 30.

Set ID = All = 00
 Data 00 = Don't know Physical = 00
 Data 01 & 02 = Major is 30 = 00 1E
 Data 03 & 04 = Don't Care = 00 00
 Data 05 = Digital BS TV = 07
 Total = **ma 00 00 00 1E 00 00 07**

* This feature is varied based on the model.

Ack [a][][Set ID][][OK][Data 00][Data 01]
 [Data 02][Data 03][Data 04][Data 05]
 [x][a][][Set ID][][NG][Data 00][x]

21. Channel(Programme) Add/Del(Skip)
(Command: m b)

► To skip current channel(programme) for next time.

Transmission [m][b][][Set ID][][Data][Cr]

Data 00 : Del(ATSC,ISDB)/Skip(DVB) 01 : Add

Ack [b][][Set ID][][OK/NG][Data][x]

* Set the saved channel status to del(ATSC, ISDB)/skip(DVB) or add.

22. Key (Command: m c)

► To send IR remote key code.

Transmission [m][c][][Set ID][][Data][Cr]

Data Key code - p.2.

Ack [c][][Set ID][][OK/NG][Data][x]

23. Control Backlight (Command: m g)

• For LCD TV / LED TV

► To control the backlight.

Transmission [m][g][][Set ID][][Data][Cr]

Data Min : 00 to Max : 64

Ack [g][][Set ID][][OK/NG][Data][x]

Control Panel Light (Command: m g)

• For Plasma TV

► To control the panel light.

Transmission [m][g][][Set ID][][Data][Cr]

Data Min : 00 to Max : 64

Ack [g][][Set ID][][OK/NG][Data][x]

24. Input select (Command: x b)
(Main Picture Input)

► To select input source for main picture.

Transmission [x][b][][Set ID][][Data][Cr]

Data

00 : DTV	01 : CADTV
02 : Satellite DTV	10 : ATV
	ISDB-BS (Japan)
03 : ISDB-CS1 (Japan)	
04 : ISDB-CS2 (Japan)	
11 : CATV	
20 : AV or AV1	21 : AV2
40 : Component1	41 : Component2
60 : RGB	
90 : HDMI1	91 : HDMI2
92 : HDMI3	93 : HDMI4

Ack [b][][Set ID][][OK/NG][Data][x]

* This function depends on model and signal.

25. 3D(Command: x t) (only 3D models)
(Depending on model)

► To change 3D mode for TV.

Transmission [x][t][][Set ID][][Data 00][][Data 01]
 [][Data 02][][Data 03][Cr]

* (Depending on model)

Data Structure

[Data 00] 00 : 3D On
 01 : 3D Off
 02 : 3D to 2D
 03 : 2D to 3D

[Data 01] 00 : Top and Bottom
 01 : Side by Side
 02 : Check Board
 03 : Frame Sequential
 04 : Column interleaving
 05 : Row interleaving

[Data 02] 00 : Right to Left
 01 : Left to Right

[Data 03] 3D Effect(3D Depth): Min : 00 - Max : 14
 (*transmit by Hexadecimal code)

- * [Data 02], [Data 03] functions depend on model and signal.
- * If [Data 00] is 00 (3D On), [Data 03] has no meaning.
- * If [Data 00] is 01 (3D off) or 02 (3D to 2D), [Data 01], [Data 02] and [Data 03] have no meaning.
- * If [Data 00] is 03 (2D to 3D), [Data 01] and [Data 02] have no meaning.
- * If [Data 00] is 00 (3D On) or 03 (2D to 3D), [Data 03] works when 3D Mode (Genre) is manual only.
- * All 3D pattern options ([Data 01]) may not be available according to broadcasting/video signal.

[Data 00]	[Data 01]	[Data 02]	[Data 03]
00	O	O	O
01	X	X	X
02	X	X	X
03	X	O	O

X : don't care

```
Ack [t][ ][Set ID][ ][OK][Data00][Data01][Data02][Data03][x][t][ ][Set ID][ ][NG][Data00][x]
```

26. Extended 3D(Command: x v) (only 3D models) (Depending on model)

- ▶ To change 3D option for TV.

```
Transmission [x][v][ ][Set ID][ ][Data 00][ ][Data 01][Cr]
```

- [Data 00] 3D option
- 00 : 3D Picture Correction
 - 01 : 3D Depth (3D Mode is Manual Only)
 - 02 : 3D Viewpoint
 - 06 : 3D Color Correction
 - 07 : 3D Sound Zooming
 - 08 : Normal Image View
 - 09 : 3D Mode (Genre)

[Data 01] It has own range for each 3D option determined by [Data 00].

- 1) When [Data 00] is 00
 - 00 : Right to Left
 - 01 : Left to Right
- 2) When [Data 00] is 01, 02
 - Data Min: 0 - Max: 14 (*transmit by Hexadecimal code)
 - Data value range(0 - 20) converts Viewpoint range (-10 - +10) automatically (Depending on model)
 - * This option works when 3D Mode (Genre) is manual only.

- 3) When [Data 00] is 06, 07
 - 00 : Off
 - 01 : On
 - 4) When [Data 00] is 08
 - 00 : Revert to 3D video from 3D-to-2D converted 2D video
 - 01 : Change 3D video to 2D video, except 2D-to-3D video
- * If conversion condition doesn't meet, command is treated as NG.

- 5) When [Data 00] is 09
 - 00 : Standard
 - 01 : Sport
 - 02 : Cinema
 - 03 : Extreme
 - 04 : Manual
 - 05 : Auto

```
Ack [v][ ][Set ID][ ][OK][Data00][Data01][x][v][ ][Set ID][ ][NG][Data00][x]
```

27. Auto Configure (Command: j u) (Depending on model)

- ▶ To adjust picture position and minimize image shaking automatically. It works only in RGB (PC) mode.

```
Transmission [j][u][ ][Set ID][ ][Data][Cr]
```

Data 01 : To set Auto Configure

```
Ack [u][ ][Set ID][ ][OK/NG][Data][x]
```

