

Pioneer

X-CM56/X-CM56D

CD Receiver System

Register your product on

<http://www.pioneer.eu>

(Europe)

Operating Instructions

EAC

COMPACT
disc
DIGITAL AUDIO

 Bluetooth®

™

CAUTION

TO PREVENT THE RISK OF ELECTRIC SHOCK, DO NOT REMOVE COVER (OR BACK). NO USER-SERVICEABLE PARTS INSIDE. REFER SERVICING TO QUALIFIED SERVICE PERSONNEL.

D3-4-2-1-1_B1_En

WARNING

This equipment is not waterproof. To prevent a fire or shock hazard, do not place any container filled with liquid near this equipment (such as a vase or flower pot) or expose it to dripping, splashing, rain or moisture.

D3-4-2-1-3_A1_En

WARNING

To prevent a fire hazard, do not place any naked flame sources (such as a lighted candle) on the equipment.

D3-4-2-1-7a_A1_En

VENTILATION CAUTION

When installing this unit, make sure to leave space around the unit for ventilation to improve heat radiation (at least 25 cm at top, 15 cm at rear, and 5 cm at each side).

WARNING

Slots and openings in the cabinet are provided for ventilation to ensure reliable operation of the product, and to protect it from overheating. To prevent fire hazard, the openings should never be blocked or covered with items (such as newspapers, table-cloths, curtains) or by operating the equipment on thick carpet or a bed.

D3-4-2-1-7b*_A1_En

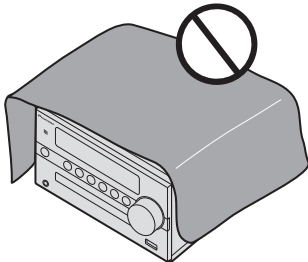

Operating Environment

Operating environment temperature and humidity:
+5 °C to +35 °C (+41 °F to +95 °F); less than 85 %RH
(cooling vents not blocked)

Do not install this unit in a poorly ventilated area, or in locations exposed to high humidity or direct sunlight (or strong artificial light)

D3-4-2-1-7c*_A1_En

CAUTION

The **STANDBY/ON** switch on this unit will not completely shut off all power from the AC outlet. Since the power cord serves as the main disconnect device for the unit, you will need to unplug it from the AC outlet to shut down all power. Therefore, make sure the unit has been installed so that the power cord can be easily unplugged from the AC outlet in case of an accident. To avoid fire hazard, the power cord should also be unplugged from the AC outlet when left unused for a long period of time (for example, when on vacation).

D3-4-2-2-2a*_A1_En

CAUTION

This product is a class 1 laser product classified under the Safety of laser products, IEC 60825-1:2007.

CLASS 1 LASER PRODUCT

D58-5-2-2a_A1_En

This product is for general household purposes. Any failure due to use for other than household purposes (such as long-term use for business purposes in a restaurant or use in a car or ship) and which requires repair will be charged for even during the warranty period.

K041_A1_En

POWER-CORD CAUTION

Handle the power cord by the plug. Do not pull out the plug by tugging the cord and never touch the power cord when your hands are wet as this could cause a short circuit or electric shock. Do not place the unit, a piece of furniture, etc., on the power cord, or pinch the cord. Never make a knot in the cord or tie it with other cords. The power cords should be routed such that they are not likely to be stepped on. A damaged power cord can cause a fire or give you an electrical shock. Check the power cord once in a while. When you find it damaged, ask your nearest our authorized service center or your dealer for a replacement.

S002*_A1_En

Information for users on collection and disposal of old equipment and used batteries

(Symbol for equipment)



These symbols on the products, packaging, and/or accompanying documents mean that used electrical and electronic products and batteries should not be mixed with general household waste.

For proper treatment, recovery and recycling of old products and used batteries, please take them to applicable collection points in accordance with your national legislation.

By disposing of these products and batteries correctly, you will help to save valuable resources and prevent any potential negative effects on human health and the environment which could otherwise arise from inappropriate waste handling.

For more information about collection and recycling of old products and batteries, please contact your local municipality, your waste disposal service or the point of sale where you purchased the items.

These symbols are only valid in the European Union.

For countries outside the European Union:

If you wish to discard these items, please contact your local authorities or dealer and ask for the correct method of disposal.

(Symbol examples for batteries)



Radio wave caution

This unit uses a 2.4 GHz radio wave frequency, which is a band used by other wireless systems (Microwave ovens and Cordless phones, etc.). In this event noise appears in your television image, there is the possibility this unit (including products supported by this unit) is causing signal interference with the antenna input connector of your television, video, satellite tuner, etc. In this event, increase the distance between the antenna input connector and this unit (including products supported by this unit).

- We are not responsible for any malfunction of the compatible product due to communication error/malfunctions associated with your network connection and/or your connected equipment. Please contact your Internet service provider or network device manufacturer.
- A separate contract with/payment to an Internet service provider is required to use the Internet.

WARNING

Store small parts out of the reach of children and infants. If accidentally swallowed, contact a doctor immediately.

K058a_A1_En

Thank you for buying this Pioneer product.

Please read through these operating instructions so that you will know how to operate your model properly. After you have finished reading the instructions, put them in a safe place for future reference.

Contents

01 Before you start

What's in the box	5
Loading the batteries in the remote control	5
Using the remote control	5

02 Part names and functions

Remote control	6
Front panel	8
Attaching the Non-skid pads	8
Speaker system	9
Attaching the Non-skid pads	9

03 Connections

Speaker connection	10
Connecting antennas	11
Using external antennas	11
Plugging in	12

04 Getting started

To turn the power on	13
Setting the clock	13
General control	13
Input function	13
Display brightness control	13
Volume auto set-in	13
Volume control	13
Muting	13
Sound controls	14
Equalizer	14
P.BASS control	14
BASS/TREBLE control	14
Setting the wake-up timer	14
Calling the wake-up timer	15
Cancelling the wake-up timer	15
Using the wake-up timer	15
Using the sleep timer	15
Using Headphones	15

05 Disc playback

Playing discs or files	16
Load the disc	16
Play tracks on a CD	16
Play MP3 music files	16
Advanced CD or MP3 disc playback	17
Repeat play	17
Random play	17
Programmed play (CD)	18
About downloading MP3	18
Switch the display contents	18

06 USB playback

Playing USB storage devices	19
Repeat play	19
Random play	19
Switch the display contents	19

07 Using the tuner

Listening to FM (X-CM56D)/	
Listening to FM or AM (X-CM56)	20
Tuning	20
Saving station presets	20
Using the Radio Data System (RDS)	
(for European models only)	21
Listening to the DAB+ (X-CM56D only)	23
About DAB+ (Digital Audio Broadcasting)	23
Tuning	23
Changing the information display	24
Memorising a station	24
DAB Frequency table (BAND III)	24

08 Other connections

Connecting auxiliary components	25
---------------------------------	----

09 Bluetooth® Audio playback

Music playback using Bluetooth wireless technology	26
Remote control operation	26
Pairing with the unit (Initial registration)	26
Listen to music on the unit	
from a Bluetooth capable device	27
BT STANDBY	27
Pairing and connection using NFC	28
Radio wave caution	28
Scope of operation	29
Radio wave reflections	29
Precautions regarding connections	
to products supported by this unit	29

10 Additional information

Troubleshooting	30
Playable discs and formats	32
Regarding copy protected CDs	33
Supported audio file formats	33
Cautions on use	33
When moving this unit	33
Place of installation	33
Do not place objects on this unit	33
About condensation	33
Cleaning the product	34
Cleaning the lens	34
Handling discs	34
Storing	34
Cleaning discs	34
About specially shaped discs	34
Auto power off setting	34
Restoring all the settings to the defaults	34
Specifications	35

Chapter 1:

Before you start

What's in the box

Please confirm that the following accessories are in the box when you open it.

- Remote Control
- AAA batteries (R03) x 2
- Power cord
- Speaker wire x 2
- AM antenna cable*1
- FM wire antenna*1
- DAB/FM wire antenna*2
- Non-skid pads x 12
- Warranty card*3
- Operating instructions (this document)

*1 X-CM56 only

*2 X-CM56D only

*3 European models only

Loading the batteries in the remote control

1 Open the rear lid and load the batteries as illustrated below.

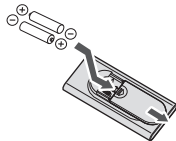

2 Close the rear lid.



CAUTION

- Do not use any batteries other than the ones specified. Also, do not use a new battery together with an old one.
- When inserting the batteries, make sure not to damage the springs on the battery's \ominus terminals. This can cause batteries to leak or over heat.
- When loading the batteries into the remote control, set them in the proper direction, as indicated by the polarity marks (\oplus and \ominus).

- Do not heat batteries, disassemble them, or throw them into flames or water.
- Batteries may have different voltages, even if they are the same size and shape. Do not use different types of batteries together.
- To prevent leakage of battery fluid, remove the batteries if you do not plan to use the remote control for a long period of time (1 month or more). If the fluid should leak, wipe it carefully off the inside of the case, then insert new batteries. If a battery should leak and the fluid should get on your skin, flush it off with large quantities of water.
- When disposing of used batteries, please comply with governmental regulations or environmental public institution's rules that apply in your country/area.

WARNING

- Do not use or store batteries in direct sunlight or other excessively hot place, such as inside a car or near a heater. This can cause batteries to leak, overheat, explode or catch fire. It can also reduce the life or performance of batteries.

Using the remote control

The remote has a range of about 7 m at an angle of about 30° from the remote sensor.

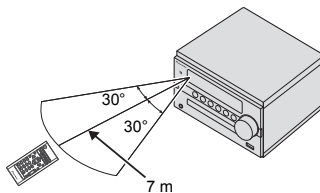

Keep in mind the following when using the remote control:

- Make sure that there are no obstacles between the remote and the remote sensor on the unit.
- Remote operation may become unreliable if strong sunlight or fluorescent light is shining on the unit's remote sensor.
- Remote controllers for different devices can interfere with each other. Avoid using remotes for other equipment located close to this unit.
- Replace the batteries when you notice a fall off in the operating range of the remote.

Chapter 2:

Part names and functions

Remote control

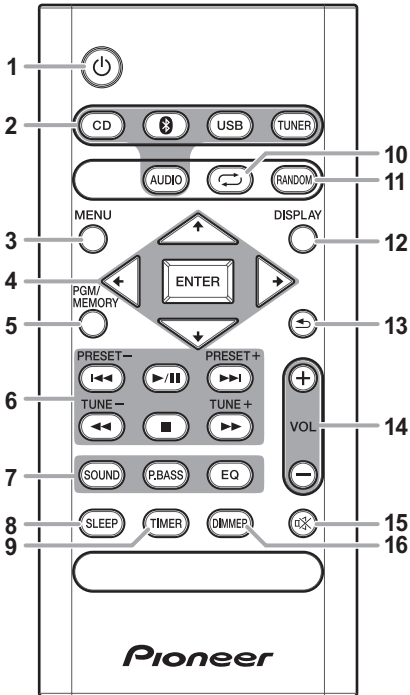
**1**

Switches the receiver between standby and on (page 13).

2 Input function buttons

Use to select the input source to this receiver (page 13).



Use to set up or play the audio file using the *Bluetooth* network (page 26).

3 MENU

Use to access the menu.

4

Use to select/switch system settings and modes, and to confirm actions.

5 PGM/MEMORY

- Use to memory or program the CD (page 18).
- Use to store FM/AM (page 20) or DAB (page 24) stations in memory.

6 Playback control buttons

Use to control each function after you have selected it using the input function buttons (page 17).

TUNE +/-

Use to find radio frequencies (page 20).

PRESET +/-

Use to select preset radio stations (page 20).

7 Sound control buttons

Adjust the sound quality (page 14).

8 SLEEP

See *Using the sleep timer* on page 15.

9 TIMER

Use for setting the clock, as well as for setting and checking the timers (page 13).

10

Press to change the repeat play setting from a CD (page 17) or USB (page 19).

11 RANDOM

Press to randomize order play setting from a CD (page 17) or USB (page 19).

12 DISPLAY

Press to change the display for MP3 (page 18), RDS (page 21) or DAB (page 24) information.

13

Press to return to the previous display.

14 Volume control buttons

Use to set the listening volume (page 13).

15

Mutes/unmutes the sound (page 13).

16 DIMMER

Dims or brightens the display. The brightness can be controlled in four steps (page 13).

Front panel

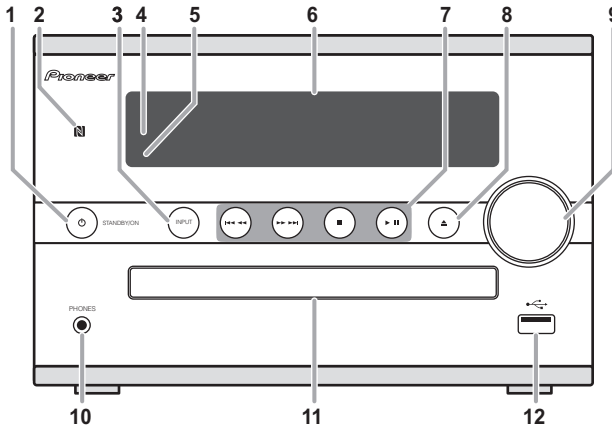
**1** **STANDBY/ON**

Switches the receiver between standby and on (page 13).

2 **NFC area**

Touching the NFC-equipped smartphone to this area, this unit can establish *Bluetooth* connection simply (See *Pairing and connection using NFC* on page 28).

3 **INPUT**

Selects the input source.

4 **Remote sensor**

Receives the signals from the remote control.

5 **TIMER indicator**

Lights when the receiver is power off with timer setting.

6 **Main display****7** **Playback control buttons**

Selects the desired track or file to be played back. Use to stop the playback. Stops playback or resumes playback from the pause point.

8 **Disc tray open/close button**

Use to open or close the disc tray (page 16).

9 **Volume control**

Use to set the listening volume (page 13).

10 **Headphone socket**

Use to connect headphones. When the headphones are connected, there is no sound output from the speakers.

11 **Disc tray**

Place the disc, label side up (page 16).

12 **USB terminal**

Use to connect your USB mass storage device as an audio source (page 19).

Attaching the Non-skid pads

Apply the accessory non-skid pads to the bottom surfaces of this unit.

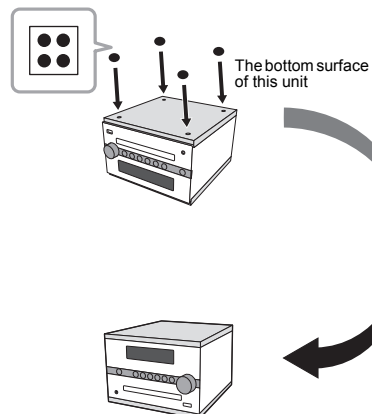

Speaker system

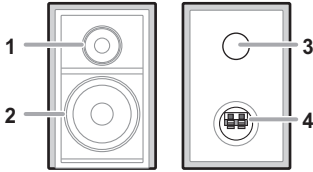

- 1 **Tweeter**
- 2 **Woofer**
- 3 **Bass Reflex Duct**
- 4 **Speaker Terminals**

Important

- Speaker grille cannot be removed.
- Both speakers can be used on either the right or the left side.

Attaching the Non-skid pads

Apply the accessory non-skid pads to the bottom surfaces of the speakers.

Important

- Use the speaker is usually in an upright position.
- Take care not to jam your fingers when connecting the receiver and the speaker and putting them in place.

When placing speakers upright

When placing the speakers vertically upright, attach the non-skid pads to the bottom surface of the speakers.

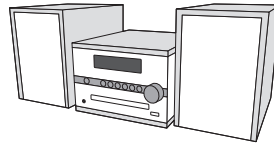
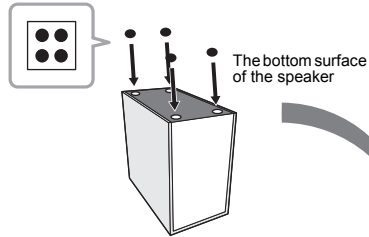

When placing speakers horizontally

When placing the speaker horizontally, attach the non-skid pads to what will be the bottom surface of the speakers.

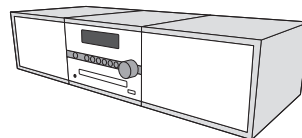
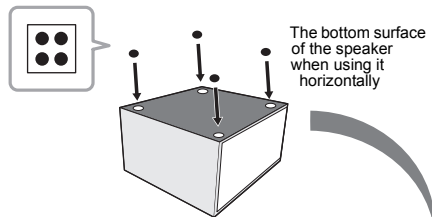

Chapter 3:

Connections

⚠ CAUTION

- Be sure to turn off the power and unplug the power cord from the power outlet whenever making or changing connections.
- Connect the power cord after all the connections between devices have been completed.

Speaker connection

- Push open the tabs and insert exposed wire.
- The provided speaker wire with red tube is for the (+) terminal. Connect the wire with red tube the (+) terminal, and other wire to the (-) terminal.
- Both speakers can be used on either the right or the left side.

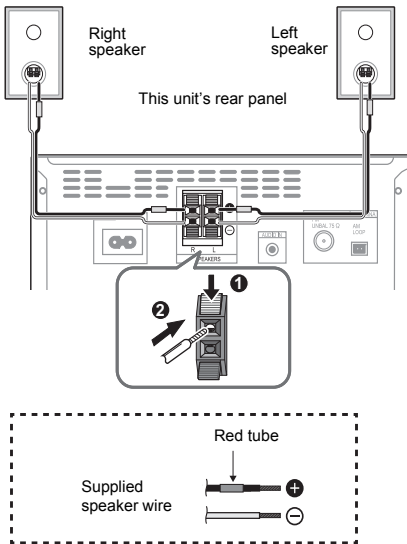
**⚠ CAUTION**

- These speaker terminals carry **HAZARDOUS LIVE voltage**. To prevent the risk of electric shock when connecting or disconnecting the speaker cables, disconnect the power cord before touching any uninsulated parts.
- Do not connect any speakers other than those supplied to this system.
- Do not connect the supplied speakers to any amplifier other than the one supplied with this system. Connection to any other amplifier may result in malfunction or fire.
- Do not attach these speakers to the wall or ceiling. They may fall off and cause injury.
- Do not install your speakers overhead on the ceiling or wall. The grill is designed to be detachable, and as such it may fall and cause damage or personal injury if installed overhead.
- These speakers are magnetically shielded. However, depending on the installation location, color distortion may occur if the speaker system is installed extremely close to the screen of a television set. If this happens, turn off the television set, and then turn it on after 15 to 30 minutes. If the problem persists, move the speaker system away from the television set.
- Make sure that the speaker cable cores do not become exposed and make contact with other cable cores. This may cause malfunction of the product.
- Do not allow the speaker cable core to come into contact with the receiver body.

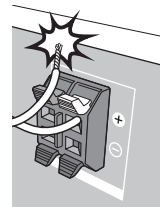

- If the speaker cable core comes into contact with any metal portion of the receiver's body, it may damage the speakers and cause smoke and fire. Insert speaker cables securely into the terminals and check that the cable does not come out of easily.

🔧 Note

- There is no difference between L and R speakers.

Connecting antennas

- Connect the AM loop antenna and the FM (DAB/FM) wire antenna as shown below.
- To improve reception and sound quality, connect external antennas (see *Using external antennas*).

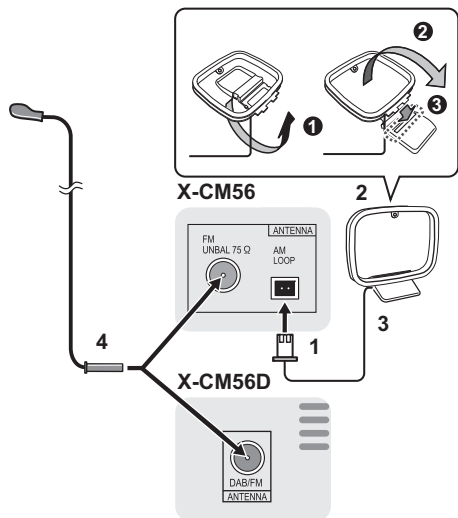

1 Connect the AM antenna wires.

Holding the connector to connect.

2 Fix the AM loop antenna to the attached stand.

Set up as illustrated above.

3 Place the AM antenna on a flat surface and in a direction giving the best reception.

- Place the antenna near a window, etc. for the best reception.
- Do not place the antenna near a computer or TV. It may result in noise.

4 Connect the FM (DAB/FM) wire antenna into the FM antenna socket.

For best results, extend the FM (DAB/FM) antenna fully and fix to a wall or door frame. Don't drape loosely or leave coiled up.

Using external antennas

To improve FM reception

Use a PAL connector (not supplied) to connect an external FM (DAB/FM) antenna.

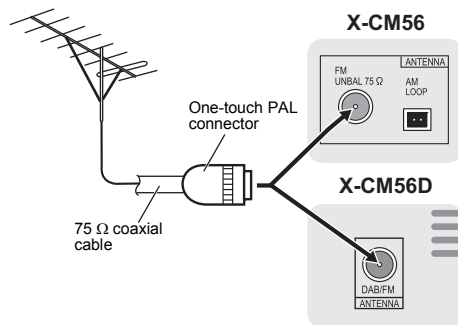

Plugging in

Before making or changing the connections, switch off the power and disconnect the power cord from the AC outlet. After you've finished making all connections, plug the unit into an AC outlet.

This unit's rear panel

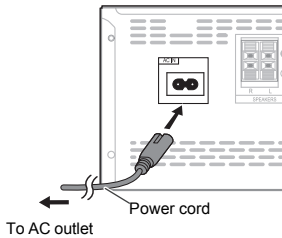

⚠ CAUTION

- Do not use any power cord other than the one supplied with this unit.
- Do not use the supplied power cord for any purpose other than that described above.

Chapter 4:

Getting started





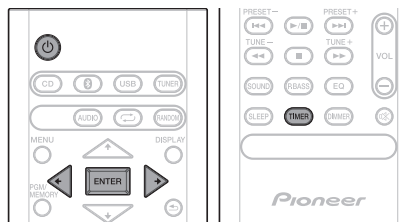

To turn the power on

Press the  to turn the power on.

After use:

Press the  to enter the power stand-by mode.

Setting the clock

- 1 Press  to turn the power on.
- 2 Press **TIMER** on the remote control.
"CLOCK" is shown on the main display.
- 3 Press **ENTER**.
- 4 Press  /  to set the day, then press **ENTER**.
- 5 Press  /  to set the hour, then press **ENTER**.
- 6 Press  /  to set the minute, then press **ENTER** to confirm.
- 7 Press **ENTER**.

To confirm the time display:

Press the **TIMER**. The time display will appear for about 10 seconds.

To readjust the clock:

Perform "Setting the clock" from step 1.

Note

- When power supply is restored after unit is plugged in again or after a power failure, reset the clock.

General control**Input function**

When the **INPUT** on main unit is pressed, the current function will change to different mode. Press the **INPUT** repeatedly to select desired function.



*1 X-CM56D only

*2 X-CM56 only

Display brightness control

Press **DIMMER** to dims the display brightness. The brightness can be controlled in four steps.

Volume auto set-in

If you turn off and on the main unit with the volume set to 31 or higher, the volume starts at 30 and sets in to the last set level.

Volume control

Turn the volume knob towards **VOLUME** (on main unit) or press **VOL +/-** (on remote control) to increase or decrease the volume.

CAUTION

- The sound level at a given volume setting depends on speaker efficiency, location, and various other factors. It is advisable to avoid exposure to high volume levels. Do not turn the volume on to full at switch on. Listen to music at moderate levels. Excessive sound pressure from earphones and headphones can cause hearing loss.

Muting

The volume is muted temporarily when pressing the  on the remote control. Press again to restore the volume.

Sound controls

Equalizer

When the **EQ** is pressed, the current mode setting will be displayed. To change to a different mode, press the **EQ** repeatedly until the desired sound mode appears.

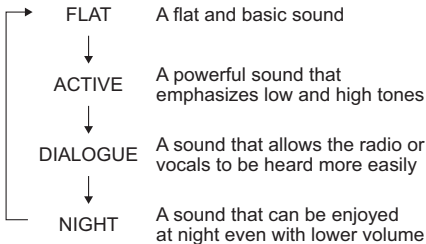

P.BASS control

When the power is first turned on, the unit will enter the P.bass mode which emphasises the bass frequencies. To cancel the P.bass mode, press the **P.BASS** on the remote control.

BASS/TREBLE control

Press the **SOUND** to select "BASS" or "TREBLE", then press **←/→** to adjust the bass or treble.



Note

- The **EQ** and **P.BASS** cannot operate simultaneously. The most recently selected of these two functions will be the one used.
- **SOUND** can operate alongside either the **EQ** or **P.BASS**.

When one of the above two functions is selected, the function that is not selected will be displayed as follows.

- 1 When **P.BASS** setting (ON/OFF) is changed
 - EQ : FLAT
- 2 When **EQ** setting is changed
 - P.BASS : OFF

Setting the wake-up timer

Used to change the existing timer setting, or to set a new timer.

- 1 Press **⏻** to turn the power on.
- 2 Press and hold **TIMER** on the remote control.
- 3 Press **←/→** to select "ONCE" or "DAILY", then press **ENTER**.
 - ONCE** – Once timer play works for one time only at a preset time.
 - DAILY** – Daily timer play works at the same preset time and days of week.
- 4 Press **←/→** to select "TIMER SET", then press **ENTER**.
- 5 Press **←/→** to select the timer playback source, then press **ENTER**.
CD, DAB (X-CM56D only), FM, AM (X-CM56 only), and USB can be selected as the playback source.
- 6 Press **←/→** to select the timer day, then press **ENTER**.
- 7 Press **←/→** to set the hour, then press **ENTER**.
- 8 Press **←/→** to set the minute, then press **ENTER**.
Set the time to finish as in steps 7 and 8 above.
- 9 Adjust the volume press **VOL +/-**, then press **ENTER**.
"⏻" appears on the display.
- 10 Press **⏻** to enter the power standby mode.
The **TIMER** indicator lights up.

Calling the wake-up timer

It can be used to re-use an existing timer setting.

1 As well as steps 1 through 3 in “Setting the wake-up timer”.

2 Press **◀ / ▶** to select “TIMER ON”, then press **ENTER**.

Cancelling the wake-up timer

It can be used to turn off the timer setting.

1 As well as steps 1 through 3 in “Setting the wake-up timer”.

2 Press **◀ / ▶** to select “TIMER OFF”, then press **ENTER**.

Using the wake-up timer

1 Press **⏻** to turn the power off.

2 At the wake-up time, this unit will turn on automatically and play the selected input function.

Note

- If at the wake-up time the USB storage device is not connected to this unit or a disc is not inserted, this unit will be turned on and not play back the track.
- Some discs may not be played automatically at the wake-up time.
- If you set the timer, take one minute or more between the start and end time.

Using the sleep timer

The sleep timer switches off the unit after a specified time so you can fall asleep without worrying about it.

1 Press **SLEEP** repeatedly to select a switch off time.

Choose between 10 min, 20 min, 30 min, 60 min, 90 min, 120 min, 150 min, 180 min or OFF. The newly set value displays for 3 seconds, and then the setting is completed.

Note

- The sleep timer can be set by pressing **SLEEP** while the remaining time is displayed.

Using Headphones

Connect to the jack plug of the headphones.

When the headphones are connected, there is no sound output from the speakers.

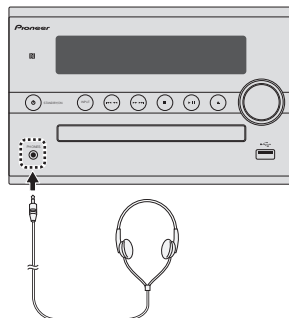

- Do not turn the volume on to full at switch on and listen to music at moderate levels. Excessive sound pressure from earphones and headphones can cause hearing loss.
- Before plugging in or unplugging the headphone, reduce the volume.
- Be sure your headphone has a 3.5 mm diameter plug and impedance between 16 Ω and 50 Ω . The recommended impedance is 32 Ω .

Chapter 5:



Disc playback

This system can play back a standard CD, CD-R/RW in the CD format and CD-R/RW with MP3 files, but cannot record on them. Some audio CD-R and CD-RW discs may not be playable due to the state of the disc or the device that was used for recording.

- For details about MP3, see page 33.

Playing discs or files

Load the disc

- 1 Press  to turn the power on.
- 2 Press **CD** on the remote control or **INPUT** repeatedly on the main unit to select CD input.
- 3 Press  on the main unit to open the disc tray.
- 4 Place the disc on the disc tray, label side up.

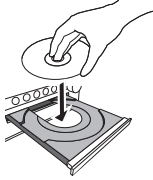

- 5 Press  on the main unit to close the disc tray.

Play tracks on a CD

- 1 When the recognition is completed, press .







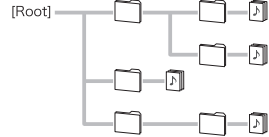

After the last track is played, the unit will stop automatically.

Play MP3 music files

MP3 track data is called "music file" and the location they are stored is called a "folder" in this document.

e.g.,



- 1 When the recognition is completed, press  to select the folder where the music file is stored () , then press  or **ENTER**.
 - Repeat this step if there are other folders inside the selected folder.
 - To return to the previous folder, press  or .
- 2 Press  to select the music file () , and then press  or **ENTER**.
 - Once play starts, only music files inside the same folder can be played continuously.

⚠ CAUTION

- Do not place two discs in one disc tray.
- Do not play discs of special shapes (heart, octagon, etc). It may cause malfunctions.
- Do not push the disc tray whilst it is moving.
- If the power fails whilst the tray is open, wait until the power is restored.
- Be sure to place 8 cm disc in the middle of the disc tray.

📌 Note

- Due to the structure of the disc information, it takes longer to read an MP3 disc than a normal CD (approximately 20 to 90 seconds).
- When the beginning of the first track is reached during fast reverse, the unit will enter the playback mode (only for CD).
- If TV or radio interference occurs during CD operation, move the unit away from the TV or radio.

⚙ Tip

- When no operation has done in CD mode and the audio file is not played for more than 20 minutes, the power will automatically turn off. In this case it is required that the Auto power off is switched to **ON**.
- Auto power off can be switched to **ON/OFF** (page 34).

Basic operations

Function	Main unit	Remote control	Operation
Play			Press in the stop mode.
Stop			Press in the playback mode. (when playing a CD) "RESUME" is displayed and the place where you stopped play is memorized. Press again and the memorized position is cleared.
Pause			Press in the playback mode. Press to resume playback from the paused point.
Track up/down			Press in the playback or stop mode. If you press the button in the stop mode, press to start the desired track. (when playing MP3) You can only skip forward or back to music files inside the same folder.
Fast forward/reverse			Press and hold down in the playback mode. Release the button to resume playback.

Advanced CD or MP3 disc playback

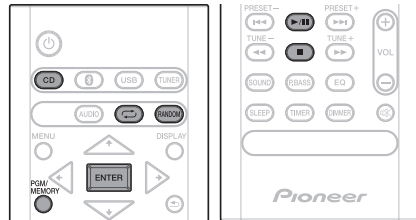

Repeat play

Repeat play can play one track, all tracks or a programmed sequence continuously.

To repeat one track:

Press repeatedly until "REPEAT ONE" appears. Press **ENTER**.

To repeat all tracks:

Press repeatedly until "REPEAT ALL" appears. Press **ENTER**.

To repeat desired tracks:

Perform steps 1 - 5 in "Programmed play (CD)" section (page 18) and then press repeatedly until "REPEAT ALL" appears. Press **ENTER**.

To cancel repeat play:

Press repeatedly until "REPEAT OFF" appears. Press **ENTER**.

Note

- After performing repeat play, be sure to press . Otherwise, the disc will play continuously.
- During repeat play, random play is not possible.

Random play

The tracks on the disc can be played in random order automatically.

To random play all tracks:

Press **RANDOM** repeatedly until "RANDOM ON" appears. Press **ENTER**.

To cancel random play:

Press **RANDOM** repeatedly until "RANDOM OFF" appears. Press **ENTER**.

Note

- If you press the during random play, you can move to the track selected next by the random operation.
- In random play, the unit will select and play tracks automatically. (You cannot select the order of the tracks.)
- During random play, repeat play is not possible.

Programmed play (CD)

You can choose up to 24 selections for playback in the order you like.

- 1 Whilst in the stop mode, press **PGM/MEMORY** on the remote control to enter the programming save mode.
- 2 Press **◀◀ ▶▶** to select the desired tracks.
- 3 Press **ENTER** to save track number.
- 4 Repeat steps 2 - 3 for other tracks. Up to 24 tracks can be programmed.
 - If you want to check the programmed tracks, press **PGM/MEMORY**.
 - If you make a mistake, the last programmed tracks will be canceled by pressing **↶**.
- 5 Press **▶||** to start playback.

To cancel the programmed play mode:

To cancel the programmed play, press twice **■** on the remote control. The display will show "PRG CLEAR" and all the programmed contents will be cleared.

Adding tracks to the program:

Press the **PGM/MEMORY**. Then follow steps 2 - 3 to add tracks.

Note

- When a disc is ejected, the program is automatically cancelled.
- If you press the **⏻** to enter the standby mode or change the function from **CD** to another, the programmed selections will be cleared.
- During the program operation, random play is not possible.

About downloading MP3

There are many music sites on the internet that you can download MP3 music files. Follow the instructions from the website on how to download the music files. You can then play back these downloaded music files by burning them to a CD-R/RW disc.

- Your downloaded song/files are for personal use only. Any other usage of the song without owner's permission, is against the law.

Switch the display contents

1 Press **DISPLAY** during playback.

If the title, artist and album name has been written to the file, that information will be displayed. (You can view this unit is only alphanumeric characters. Non- alphanumeric character are displayed in the "■".)

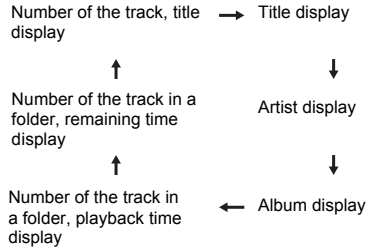

Note

- "Not supported playback file" can not be playback. In this case, will be skipped automatically.
- There may be cases where no information can be displayed.
- Displaying title, artist, and albums is only supported with ID3 Version 1 (1.0 or 1.1).

Chapter 6:

USB playback

Playing USB storage devices

It is possible to listen to two-channel audio using the USB interface with MP3 files on the front of this receiver.

- Pioneer does not guarantee that any file recorded on a USB storage device will play or that power will be supplied to a USB storage device. Also note that Pioneer will accept no responsibility whatsoever for loss of files on USB storage devices caused by connection to this unit.
- For details about MP3, see page 33.

1 Press USB as the input source.

"USB" is shown on the main display.

2 Connect the USB storage device.

- This receiver does not support a USB hub.

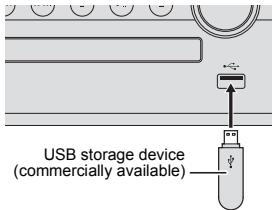
3 When the recognition is completed, press \uparrow/\downarrow to select the folder where the music file is stored ([■]), then press \rightarrow or ENTER.

- MP3 track data is called "music file" and the location they are stored is called a "folder" in this document.
- Repeat this step if there are other folders inside the selected folder.
- To return to the previous folder, press \leftarrow or \curvearrowright .

4 Press \uparrow/\downarrow to select the music file ([♪]), and then press \blacktriangleright or ENTER.

- Once play starts, only music files inside the same folder can be played continuously.
- For details about the basic operations, see page 17.
- When changing to a different input source, stop the USB memory playback first, before changing.
- Turn the power off before removing the USB storage device.

Note

- This unit may not recognize a USB storage device, play files or supply power to a USB storage device. For details, see *When a USB storage device is connected* on page 31.
- When a USB storage device is not playing and the unit has not been operated for 20 minutes or more, the power will automatically turn off. In this case it is required that the Auto power off is switched to **ON** (page 34).

Repeat play

Repeat play can play one track, all tracks or a programmed sequence continuously.

To repeat one track:

Press \curvearrowright repeatedly until "REPEAT ONE" appears. Press ENTER.

To repeat all tracks:

Press \curvearrowright repeatedly until "REPEAT ALL" appears. Press ENTER.

To cancel repeat play:

Press \curvearrowright repeatedly until "REPEAT OFF" appears. Press ENTER.

Note

- After performing repeat play, be sure to press \blacksquare . Otherwise, the file of USB storage device will play continuously.
- During repeat play, random play is not possible.

Random play

The file of USB storage device can be played in random order automatically.

To random play all tracks:

Press **RANDOM** repeatedly until "RANDOM ON" appears. Press ENTER.

To cancel random play:

Press **RANDOM** repeatedly until "RANDOM OFF" appears. Press ENTER.

Note

- If you press the \blacktriangleright during random play, you can move to the track selected next by the random operation.
- In random play, the unit will select and play tracks automatically. (You cannot select the order of the tracks.)
- During random play, repeat play is not possible.

Switch the display contents

This unit can switch the information recorded in the USB storage device. For details, see *Switch the display contents* on page 18.

Chapter 7:

Using the tuner

Listening to FM (X-CM56D)/

Listening to FM or AM (X-CM56)

The following steps show you how to tune in to FM and AM radio broadcasts using the automatic (search) and manual (step) tuning functions. Once you are tuned to a station you can memorize the frequency for recall later. See *Saving station presets* below for more on how to do this.

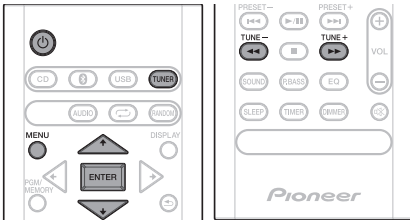

Tuning

- 1 Press the **⏻** to turn the power on.
- 2 Press **TUNER** repeatedly to select desired frequency band (FM or AM).
 - (X-CM56D) You can select "FM" and "DAB". For details about "DAB", see page 23.
- 3 Press **TUNE +/-** on the remote control to tune in to the desired station.

Automatic tuning:

Press and hold **TUNE +/-**, scanning will start automatically and the tuner will stop at the first receivable broadcast station.

Manual tuning:

Press the **TUNE +/-** repeatedly to tune in to the desired station.



Note

- When radio interference occurs, automatic tuning may stop automatically at that point.
- Automatic tuning will skip weak signal stations.
- To stop the automatic tuning, press **■**.
- When an RDS (Radio Data System) station is tuned in, the frequency will be displayed first. Finally, the station name will appear.
- Full auto tuning can be achieved for RDS stations using Auto Station Program Memory (ASPM) mode, see page 22.

To receive an FM stereo transmission:

- 1 Press **TUNER** until "FM" appears on the display.
- 2 Press **MENU** and then press **▲/▼** until "FM STEREO/MONO" appears on the display.
- 3 Press **ENTER** and then press **▲/▼** until "AUTO" appears on the display.

Improving poor FM reception:

After performing the above steps 1 - 2, press **ENTER** and then press **▲/▼** until "MONO" appears on the display.

This will change the tuner from stereo to mono and usually improve the reception.

Saving station presets

If you often listen to a particular radio station, it's convenient to have the receiver store the frequency for easy recall whenever you want to listen to that station (Preset tuning). This saves the effort of manually tuning in each time. This unit can memorize up to 45 stations.

(FM 30 stations/AM 15 stations)

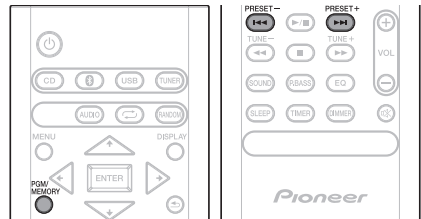

1 Tune to a station you want to memorize.

See *Tuning* above for more on this.

2 Press PGM/MEMORY.

The preset number will flash.

3 Press PRESET +/- to select the preset channel number.

4 Press PGM/MEMORY to store that station in memory.

If the preset number has changed from flashing to lighting, before the station is memorised, repeat the operation from step 2.

- Repeat steps 1 - 4 to set other stations, or to change a preset station. When a new station is stored in the memory, the station previously memorised for that preset channel number will be erased.

Note

- The backup function protects the memorised stations for a few hours should there be a power failure or the AC power cord become disconnected.

To recall a memorised station

Press **PRESET +/-** to select the desired station.

To scan the preset stations

The stations saved in the memory can be scanned automatically. (Preset memory scan)

- Press and hold **PRESET +/-**. The preset number will appear and the programmed stations will be tuned in sequentially, for 5 seconds each.
- Press **PRESET +/-** again when the desired station is located.

To erase entire preset memory

- Press **TUNER** on the remote control.
- Press **↶** until "MEMORY CLEAR" appears.

Note

- All stations will be erased.

Using the Radio Data System (RDS) (for European models only)

Radio Data System (RDS) is a system used by most FM radio stations to provide listeners with various kinds of information—the name of the station and the kind of show they're broadcasting, for example.

One feature of RDS is that you can search by type of program. For example, you can search for a station that's broadcasting a show with the program type, **Jazz Music**.

Information provided by RDS

- Press **TUNER** until "FM" appears on the display.
- Press **DISPLAY** repeatedly. Each time the **DISPLAY** is pressed, the display will switch as follows:

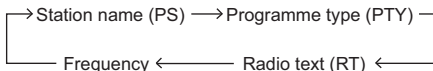

- When tuning in to a station other than an RDS station or to an RDS station which sends weak signal, the display will change in the following order:

**Search for stations by Program Type**

- Press **TUNER** until "FM" appears on the display.
- Press **MENU** and then press **▲/▼** until "FM RDS" appears on the display.
- Press **ENTER** and then press **▲/▼** until "PTY" appears on the display.
- Press **ENTER**. "SELECT" will appear for about 5 seconds.
- Press **◀/▶** to select the program type you want to hear. Each time the button is pressed, the program type will appear. If the button is held down, the program type will appear continuously.
- Whilst the selected program type is displayed (within 5 seconds), press **ENTER**. After the selected program type has been lit for 2 seconds, "SEARCH" will appear, and the search operation will start. The Program Types displayed are as follows:

News – News
Current Affairs – Current Affairs
Information – General Information
Sport – Sport
Education – Educational
Drama – Radio plays, etc.
Cultures – National or regional culture, theater, etc.
Science – Science and technology
Varied Speech – Usually talk-based material, such as quiz shows or interviews.
Pop Music – Pop music
Rock Music – Rock music
Easy Listening – Easy listening
Light Classics M – 'Light' classical music
Serious Classics – 'Serious' classical music
Other music – Music not fitting above categories
Weather & Metr – Weather reports
Finance – Stock market reports, commerce, trading, etc.
Children's Progs – Programs for children

Social affairs – Social affairs
Religion – Programs concerning religion
Phone In – Public expressing their views by Phone
Travel & Touring – Holiday-type travel rather than traffic announcements
Leisure & Hobby – Leisure interests and hobbies
Jazz Music – Jazz
Country Music – Country music
National Music – Popular music in a language other than English
Oldies Music – Popular music from the '50s and '60s
Folk Music – Folk music
Documentary – Documentary
Alarm Test – Broadcasting when testing emergency broadcast equipment or receivers.
Alarm - Alarm! – Emergency announcement made under exceptional circumstances to give warning of events causing danger of a general nature.

- If the display has stopped flashing, start again from step 2. If the unit finds a desired program type, the corresponding channel number will lit for about 8 seconds, and then the station name will remain it.
- If you want to listen to the same program type of another station, repeat steps 2 - 6. The unit will look for the next station.
- If no station can be found, "NOT FOUND" will appear for 4 seconds.

Using the Auto Station program Memory (ASPM)

Whilst in the ASPM operation mode, the tuner will automatically search for new RDS stations. Up to 30 stations can be stored.

If you have already stored some stations in memory, the number of new stations you can store will be less.

- 1 Press **TUNER** until "FM" appears on the display.
- 2 Press **MENU** and then press **▲/▼** until "FM RDS" appears on the display.
- 3 Press **ENTER** and then press **▲/▼** until "ASPM" appears on the display.
- 4 Press **ENTER**.

After "ASPM" has flashed for about 4 seconds, scanning will start (87.5 - 108 MHz).

After scanning, the number of stations stored in memory will be displayed for 4 seconds, and then "END" will appear for 4 seconds.

- To stop the ASPM operation before it is complete: Press **■** whilst it is scanning for stations. The stations which are already stored in memory will be kept there.
- If the same station is broadcasting on different frequencies, the strongest frequency will be stored in memory.
- Any station which has the same frequency as the one stored in memory will not be stored.
- If 30 stations have already been stored in memory, the scan will be aborted. If you want to redo the ASPM operation, erase the preset memory.
- If no station have been stored in memory, "NOT FOUND" will appear for about 5 seconds.
- If the RDS signals are very weak, station names may not be stored in memory.
- The same station name can be stored in different channels.
- In a certain area or during certain time periods, the station names may temporarily be different.

Note

- If any of the following events occur, it does not mean that the unit is faulty:
 - "PS", "NO PS" and a station name appear alternately, and properly.
 - If a particular station is not broadcasting properly or a station is conducting tests, the RDS reception function may not work properly.
 - When you receive an RDS station whose signal is too weak, information like the station name may not be displayed.
 - "NO PS", "NO PTY" or "NO RT" will flash for about 5 seconds, and then the frequency will be displayed.
- Notes for radio text:
 - The first 8 characters of the radio text will appear and then they will scroll across the display.
 - If you tune in to an RDS station which is not broadcasting any radio text, "NO RT" will be displayed when you switch to the radio text position.
 - Whilst radio text data is received or when the text contents change, "RT" will be displayed.

Listening to the DAB+ (X-CM56D only)

About DAB+ (Digital Audio Broadcasting)

Digital Audio Broadcasting is a digital transmission system where audio signals are converted to digital signals for broadcasting. DAB+ is broadcast as a group of data called multiplex (ensemble) which may contain one or more stations (services). Each station contains a primary service and there may be one or more secondary services. This allows several programmes or services to be transmitted on a single frequency.

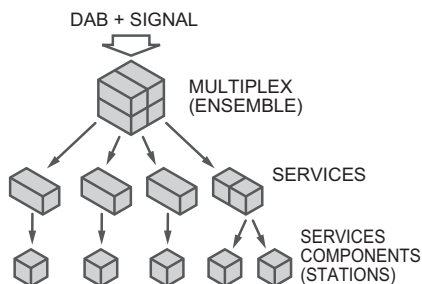

Tuning

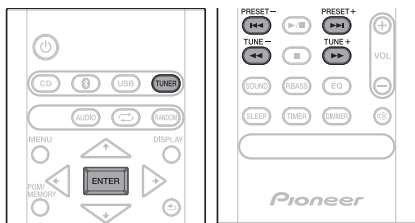

1 Press the TUNER until “DAB” appears on the display.

When turned on for the first time, the unit scans radio stations automatically to create a station list.

The stations will be stored in alphanumeric order and the first station on the list will be selected and you will hear it through the speakers.

2 Press the TUNE +/- to select the desired station.

3 Within 10 seconds, press the ENTER on the remote control to tune into the desired station.

- If no station is found, “NO SIGNAL” appears.
- Up to 100 appears for total received stations.

Auto Scan

You can make the auto scan again when you move the unit to other areas or add multiplex channels to the station list.

- 1 Press the **TUNER** until “DAB” appears on the display.
- 2 Press **MENU** and then press **▲/▼** until “DAB SCAN” appears on the display.
- 3 Press **ENTER** and then press **▲/▼** until “AUTO” appears on the display.
- 4 Press **ENTER**.

Auto Scan scanning begins.

After the scanning process is complete, the first station that was detected is selected.

Manual tune

You can manually store stations which Auto Scan cannot find. If reception is poor, you can adjust the sensitivity. Manual tune is only available after Auto tune. Perform Auto Scan first.

- 1 Press the **TUNER** until “DAB” appears on the display.
- 2 Press **MENU** and then press **▲/▼** until “DAB SCAN” appears on the display.
- 3 Press **ENTER** and then press **▲/▼** until “MANUAL” appears on the display.
- 4 Press **ENTER**.
- 5 Within 10 seconds, press the **TUNE +/-** to select the DAB+ frequency.
- 6 Within 10 seconds, press the **ENTER**.
 - If the level is too low, move the aerial or unit to improve reception.

Changing the information display

You can switch DAB+ display information.

Press the **DISPLAY** button.

Each time the button is pressed, the information display changes in the following order.

When "NO SIGNAL" appears, the **DISPLAY** button does not allow you to change the display.

[Programme Name]

Station name is displayed. (set by default)

[Scrolling text]

Information scrolls across the display when sent from the station.

[Programme type]

A description of the type of content being broadcast by the station.

[Multiplex name]

The name of the multiplex (ensemble) which provides the current service.

[Frequency]

The DAB+ frequency for the station.

[Stereo mode]

Display stereo mode.

[Transfer speed]

The data transfer speed.

[Signal quality]

The signal quality is displayed as a number (0 - 100).

[85-100: Good, 70-84: Fair, 0-69: Poor]

Memorising a station

You can store 10 DAB stations in memory and recall them at the push of a button. (Preset tuning)

1 Tune to the desired DAB station.

2 Press the PGM/MEMORY.

The preset number will flash.

3 Within 10 seconds, press the PRESET +/- to select the preset channel number.

Store the stations in memory, in order, starting with preset channel 1.

4 Within 10 seconds, press the PGM/MEMORY to store that station in memory.

If the preset number indicators disappear before the station is memorised, repeat the operation from step 2.

5 Repeat steps 1 - 4 to set other stations, or to change a preset station.

When a new station is stored in the memory, the station previously memorised for that preset channel number will be erased.

DAB Frequency table (BAND III)

Frequency	Label	Frequency	Label
174.928 MHz	5A	208.064 MHz	9D
176.640 MHz	5B	209.936 MHz	10A
178.352 MHz	5C	211.648 MHz	10B
180.064 MHz	5D	213.360 MHz	10C
181.936 MHz	6A	215.072 MHz	10D
183.648 MHz	6B	216.928 MHz	11A
185.360 MHz	6C	218.640 MHz	11B
187.072 MHz	6D	220.352 MHz	11C
188.928 MHz	7A	222.064 MHz	11D
190.640 MHz	7B	223.936 MHz	12A
192.352 MHz	7C	225.648 MHz	12B
194.064 MHz	7D	227.360 MHz	12C
195.936 MHz	8A	229.072 MHz	12D
197.648 MHz	8B	230.784 MHz	13A
199.360 MHz	8C	232.496 MHz	13B
201.072 MHz	8D	234.208 MHz	13C
202.928 MHz	9A	235.776 MHz	13D
204.640 MHz	9B	237.488 MHz	13E
206.352 MHz	9C	239.200 MHz	13F

Note

- Label is not displayed on the main display. Will displayed only frequency.

Chapter 8:

Other connections

⚠ CAUTION

- Before making or changing the connections, switch off the power and disconnect the power cord from the AC outlet.
- We will not accept responsibility for damage arising from the connection of equipment manufactured by other companies.

Connecting auxiliary components

Connect your auxiliary playback component using the **AUDIO IN** input on the rear panel.

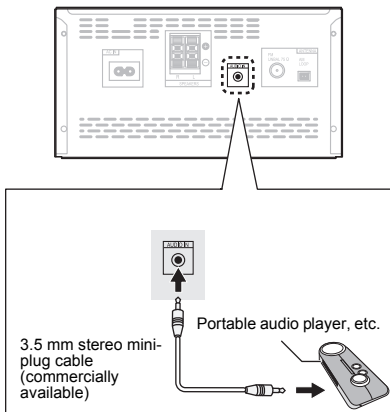

1 Press **AUDIO** as the input source.

When **AUDIO IN** is selected, "Audio In" is displayed on the main display.

📝 Note

- If the **AUDIO IN** mini-plug jack is connected to auxiliary phones jack, the volume of the unit will be adjusted by the volume on the playback component. If the sound is distorted after you lower the volume of the unit, try lowering the volume on the auxiliary playback component.

Chapter 9:

Bluetooth® Audio playback

Music playback using Bluetooth wireless technology

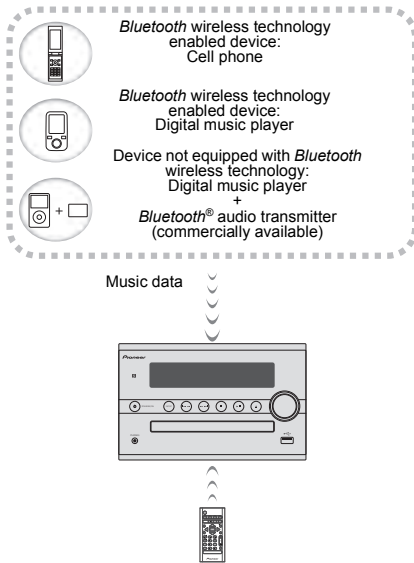

The unit is capable of playing back music stored on *Bluetooth* capable devices (cell phones, digital music players etc.) wirelessly. You can also use a *Bluetooth* audio transmitter (sold separately) to enjoy music from devices that do not have *Bluetooth* functionality. Please refer to the user's manual for your *Bluetooth* capable device for more details.

Note

- The *Bluetooth*® word mark and logos are registered trademarks owned by the Bluetooth SIG, Inc.
- The *Bluetooth* wireless technology enabled device must support A2DP profiles.
- Connection is not always guaranteed with all *Bluetooth*-enabled devices.

Remote control operation

The remote control supplied with this unit allows you to play and stop media, and perform other operations.

Note

- The *Bluetooth* wireless technology enabled device must support AVRCP profiles.
- Remote control operations cannot be guaranteed for all *Bluetooth* wireless technology enabled devices.

Pairing with the unit (Initial registration)

In order for the unit to playback music stored on a *Bluetooth* capable device, pairing must first be performed. Pairing should be performed when first using the unit with the *Bluetooth* capable device, or when the pairing data on the device has been erased for any reason.

Pairing is a step required to allow communication using *Bluetooth* wireless technology to be carried out.

- Pairing is only performed the first time that you use the unit and the *Bluetooth* capable device together.
- In order to allow communication using *Bluetooth* wireless technology to take place, pairing must be performed on both the unit and the *Bluetooth* capable device.
- After pressing the  and switching to **Bluetooth** input, perform the pairing procedure on the *Bluetooth* capable device. If pairing has been performed correctly, you will not need to perform the pairing procedures for the unit as shown below.

Please refer to the user's manual for your *Bluetooth* capable device for more details.

1 Press the  and turn the power to the unit on.

2 Press the .

The unit switches to **Bluetooth** and "Pairing" will be displayed.

3 Turn on the power to the *Bluetooth* capable device that you wish to pair with, and perform pairing procedure on it.

 **Note**

- This unit will be displayed as "Pioneer X-CM56" on all *Bluetooth* capable devices that you have.

Pairing will start.

- Place the *Bluetooth* capable device close to the unit.
- Please refer to the user's manual for your *Bluetooth* capable device for details on when pairing can be performed and the procedures required for pairing.
- When PIN code entry is requested, enter "0000." (This unit does not accept any PIN code setting other than "0000.")

4 Confirm on the *Bluetooth* capable device that pairing has been completed.

If pairing with the *Bluetooth* capable device has been completed correctly, the name of the *Bluetooth* capable device will be displayed on the front panel of the unit. (Only single-byte alphanumeric characters can be displayed. Any character that cannot be displayed will be indicated by a "■".)

Listen to music on the unit from a *Bluetooth* capable device

1 Press the .

The unit will switch to **Bluetooth** input.

2 A *Bluetooth* connection will be created between the *Bluetooth* capable device and the unit.

Procedures for connecting to the unit should be performed from the *Bluetooth* capable device.

- Please refer to the user's manual for your *Bluetooth* capable device for details of the connection procedures.

3 Playback music from the *Bluetooth* capable device.

 **Note**

- When *Bluetooth* capable device is not connected and no operations have been performed for more than 20 minutes, the unit will automatically power off. In this case it is required that the Auto power off is switched to **ON**.
- Auto power off can be switched to **ON/OFF** (page 34).

BT STANDBY

- The following can be done when the unit is on standby with the **BT STANDBY** switched **ON**.
- By selecting a *Bluetooth* capable device that already has a connection history (pairing has already been conducted) with this unit, this unit will automatically turn on with the *Bluetooth* function.

BT STANDBY settings

1 Press the .

2 Press MENU and then press  until "BT STANDBY" appears on the display.

3 Press ENTER and then press  to switch BT STANDBY ON/OFF.

- It is set to **OFF** in the factory setting.

 **Note**

- When the **BT STANDBY** is **ON**, "BT STANDBY ON" is displayed on the main display.
- When the **BT STANDBY** is **OFF**, "BT STANDBY OFF" is displayed on the main display.

Connection while in BT STANDBY mode with *Bluetooth* capable device

When connection history (pairing has already been conducted) with a *Bluetooth* capable device exists for the unit during **BT STANDBY**, the unit can receive a connection request directly from the connection history.

The unit will start using the *Bluetooth* function, and connect with a *Bluetooth* capable device.

Even devices that have already been paired with this unit will not connect during **BT STANDBY** in the following cases.

In such cases, delete pairing history from the *Bluetooth* wireless technology device and perform pairing again.

- Up to 8 pairing history can be recorded with this unit. If connecting to a *Bluetooth* wireless technology device over 8 units, the oldest pairing history will be deleted.
- If the settings are reset to the factory setting, all pairing history will be deleted.

Pairing and connection using NFC

NFC stands for Near Field Communication. If a NFC-equipped smartphone is placed close to the unit, *Bluetooth* pairing and connection can easily be established. For details, refer to the user manual for the NFC-equipped device.

Note

- Supported OS: Android 4.1 and above
- This may not operate properly, depending on the smartphone or tablet device.
- This unit automatically turns on if an NFC-equipped smartphone is held over the NFC area when **BT STANDBY** is set to **ON**.
- *The N Mark is a trademark or registered trademark of NFC Forum, Inc. in the United States and in other countries.*
- *Android is a trademark of Google Inc.*

1 Hold the device to be connected over the NFC area on the front panel of the unit.

When an NFC-equipped smartphone is detected, the input automatically switches to **Bluetooth**.

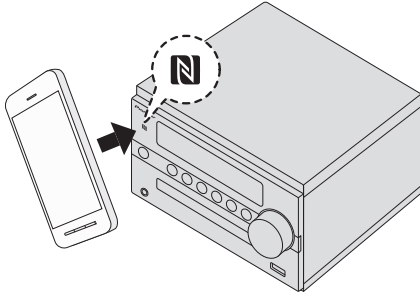

2 Pairing automatically begins.

When an NFC-equipped smartphone is detected, **Pairing** displays on the front panel display.

- Do not move the NFC-equipped smartphone until a response such as message display can be confirmed on the device. Remove the device after a response is confirmed on the device.
- If a connection does not start, change the position to hold the NFC-equipped smartphone over this unit.

3 Once connection with the NFC-equipped smartphone is completed, the device name is displayed on the front panel display of this unit.

4 Start playback of the music from the NFC-equipped smartphone.

Note

- Only one device can be connected at a time.
- NFC can also be used to quickly cancel a *Bluetooth* connection. If you perform Step 1 using a NFC-equipped smartphone that is already connected via *Bluetooth*, the connected will be cancelled.
- If another NFC-equipped smartphone is held over the NFC area, this unit connects to the device via *Bluetooth*. The connection with the previously connected device is terminated.

Radio wave caution

This unit uses a 2.4 GHz radio wave frequency, which is a band used by other wireless systems (see list below). To prevent noise or interrupted communication, do not use this unit nearby such devices, or make sure these devices are switched off during use.

- Cordless phones
- Cordless facsimiles
- Microwave ovens
- Wireless LAN devices (IEEE802.11b/g)
- Wireless AV equipment
- Wireless controllers for game systems
- Microwave-based health aids
- Some baby monitors

Other, less common, equipment that may operate on the same frequency:

- Anti-theft systems
- Amateur radio stations (HAM)
- Warehouse logistic management systems
- Discrimination systems for train or emergency vehicles

Note

- In the event noise appears in your television image, there is the possibility that a *Bluetooth* wireless technology enabled device or this unit (including products supported by this unit) are causing signal interference with the antenna input connector of your television, video, satellite tuner, etc. In this event, increase the distance between the antenna input connector and the *Bluetooth* wireless technology enabled device or this unit (including products supported by this unit).
- If there is something obstructing the path between this unit (including devices supported by this unit) and the device equipped with *Bluetooth* wireless technology (such as a metal door, concrete wall, or insulation containing tinfoil), you may need to change the location of your system to prevent signal noise and interruptions.

Scope of operation

Use of this unit is limited to home use. (Transmission distances may be reduced depending on communication environment).

In the following locations, poor condition or inability to receive radio waves may cause the audio to be interrupted or stopped:

- In reinforced concrete buildings or steel framed or iron-framed buildings.
- Near large metallic furniture.
- In a crowd of people or near a building or obstacle.
- In a location exposed to the magnetic field, static electricity or radio wave interference from radio communication equipment using the same frequency band (2.4 GHz) as this unit, such as a 2.4 GHz wireless LAN device (IEEE802.11b/g) or microwave oven.
- If you live in a heavily populated residential area (apartment, townhouse, etc.) and if your neighbor's microwave is placed near your system, you may experience radio wave interference. If this occurs, move your unit to a different place. When the microwave is not in use, there will be no radio wave interference.

Radio wave reflections

The radio waves received by this unit include the radio wave coming directly from the device equipped with *Bluetooth* wireless technology (direct wave) and waves coming from various directions due to reflections by walls, furniture and building (reflected waves). The reflected waves (due to obstacles and reflecting objects) further produce a variety of reflected waves as well as variation in reception condition depending on locations. If the audio cannot be received properly due to this phenomenon, try moving the location of the device equipped with *Bluetooth* wireless technology a little. Also note that audio may be interrupted due to the reflected waves when a person crosses or approaches the space between this unit and the device equipped with *Bluetooth* wireless technology.

Precautions regarding connections to products supported by this unit

- Complete connections for all devices supported by this unit, including all audio cords and power cables before connecting them to this unit.
- After completing connections to this unit, check the audio and power cables to confirm that they not twisted together.
- When disconnecting this unit, confirm that you have sufficient working space in the surrounding area.
- When changing connections of audio or other cables for products supported by this unit, confirm that you have sufficient working space in the surrounding area.

Chapter 10:

Additional information

Troubleshooting

Incorrect operations are often mistaken for trouble and malfunctions. If you think that there is something wrong with this component, check the points below. Sometimes the trouble may lie in another component. Investigate the other components and electrical appliances being used. If the trouble cannot be rectified even after exercising the checks listed below, ask your nearest Pioneer authorized service center or your dealer to carry out repair work.

- If the unit does not operate normally due to external effects such as static electricity disconnect the power plug from the outlet and insert again to return to normal operating conditions.

General problem

Problem	Check	Remedy
Settings you have made have been cleared.	Was the power cord unplugged?	When power cord is unplugged, the settings you have made is cleared. Please set the clock again. If you do not want to clear the settings, do not unplug the power cord.
Difference in volume between CDs, MP3, Tuner, and AUDIO IN.	This is not a problem with this unit.	The volume may sound differently depending on the input source and recording format. When using an analogue player with this unit, connect a device equipped with phono equalizer.
This unit cannot be operated with the remote control.	Are you operating from far away?	Operate within 7 m, 30° of the remote sensor on the front panel (page 5).
	Is the remote control sensor exposed to direct sunlight or strong artificial light from a fluorescent bulb, etc.?	The remote control signals may not be received properly if the remote control sensor is exposed to direct sunlight or strong artificial light from a fluorescent bulb, etc.
	Are the batteries dead?	Replace the batteries (page 5).
Disc cannot be played or disc is ejected automatically.	Is the disc scratched?	Scratched discs may not play.
	Is the disc dirty?	Wipe the dirt off the disc (page 34).
	Is this unit placed in a humid location?	There could be condensation inside. Wait a while for the condensation to evaporate. Do not place this unit near an air-conditioner, etc. (page 33).
Folder or file names are not recognized.	Have you exceeded the maximum number of folder or file names this unit can recognize?	The unit can recognize up to 999 files on a single disc or on a single USB memory device. The number of folders is up to 255. Depending on the folder structure, there may be folders or files that the unit cannot recognize.
The unit turns off automatically.		If no play back and no operation has done for 20 minutes or more, the unit turns off automatically. In this case it is required that the Auto power off is switched to ON (page 34).

When a USB storage device is connected

Problem	Check	Remedy
USB storage device is not recognized.	Is the USB storage device properly connected?	Connect the device securely (all the way in).
	Is the USB storage device connected via a USB hub?	This unit does not support USB hubs. Connect the USB storage device directly. This unit only supports USB mass storage class devices.
		This unit supports portable flash memory and digital audio playback devices. Only the FAT16 and FAT32 file systems are supported. Other file systems (exFAT, NTFS, HFS etc.) are not supported.
		This device does not support the use of external hard disc drives.
	This is not a problem with this unit.	Turn the power off then back on. Some USB storage devices may not be recognized properly.
File cannot be played.	Is the file copyright-protected (by DRM)?	Copyright-protected files cannot be played.
	This is not a problem with this unit.	Files stored on a computer cannot be played. It may not be possible to play some files.
Folder or file names are not displayed or are not properly displayed.	Do the folder or file names contain more than 30 characters?	The maximum number of characters displayable for the folder and file names is 30.
Folder or file names are not displayed in alphabetical order.	This is not a problem with this unit.	The order of the folder and file names displayed depends on the order in which the folders or files were recorded on the USB storage device.
Much time is required to recognize the USB storage device.	What is the USB storage devices capacity?	Some time may be required to load the data when large capacity USB storage devices are connected (this could take several minutes).

When the *Bluetooth* wireless technology device is connected or operated

Problem	Remedy
The <i>Bluetooth</i> wireless technology device cannot be connected or operated. Sound from the <i>Bluetooth</i> wireless technology device is not emitted or the sound is interrupted.	<p>Check that no object that emits electromagnetic waves in the 2.4 GHz band (microwave oven, wireless LAN device or <i>Bluetooth</i> wireless technology apparatus) is near the unit. If such an object is near the unit, set the unit far from it. Or, stop using the object emitting the electromagnetic waves.</p> <p>Check that the <i>Bluetooth</i> wireless technology device is not too far from the unit and that obstructions are not set between the <i>Bluetooth</i> wireless technology device and the unit. Set the <i>Bluetooth</i> wireless technology device and the unit so that the distance between them is less than about 10 m* and no obstructions exist between them.</p> <p>* The distance given is to be used as a rough guide. The actual allowable distance between devices may vary depending on conditions in the surrounding environment.</p> <p>The <i>Bluetooth</i> wireless technology device may not be set to the communication mode supporting the <i>Bluetooth</i> wireless technology. Check the setting of the <i>Bluetooth</i> wireless technology device.</p> <p>Check if this unit is connected with a <i>Bluetooth</i> wireless technology device with an input source other than Bluetooth selected. Perform pairing procedure after selecting Bluetooth as the input source.</p>
Pairing cannot be performed using the NFC function.	<p>Check the device to be connected support NFC.</p> <p>Ensure that the NFC function on the device you are trying to connect is turned on.</p> <p>If BT STANDBY is not set to ON, this unit cannot pair with a device when this unit is in standby mode. Check if BT STANDBY is set to ON.</p> <p>When pairing devices, move the NFC area (page 8) on this unit close to where the NFC antenna on the device to be paired. For the NFC antenna position on an NFC-equipped smartphone, refer to the manual supplied with the NFC-equipped smartphone.</p> <p>Use a compatible device with Android OS 4.1 or later.</p> <p>This may not operate properly, depending on the smartphone or tablet device.</p> <p>Check that "Pairing" displays on the front panel display when an NFC-equipped smartphone is held over this unit. If it is not displayed, the NFC-equipped smartphone is not recognized by this unit. Hold the NFC antenna on the NFC-equipped smartphone close to the NFC area of this unit (page 8). If the NFC-equipped smartphone is in a case, remove the case as necessary.</p>

Playable discs and formats

Audio CD	<ul style="list-style-type: none"> • Commercially available audio CDs • CD-R/-RW/-ROM discs containing music recorded in the CD-DA format
MP3	MP3 files recorded on CD-R/-RW/-ROM discs or USB storage devices

- Only the discs that have been finalized can be played.
- Discs recorded in packet write mode (UDF format) are not compatible with this unit.
- Corporation and product names mentioned herein are trademarks or registered trademarks of the respective corporations.
- Only discs recorded in ISO9660 Level 1, Level 2 and Joliet can be played.
- Files protected by DRM (Digital Rights Management) cannot be played.

MP3:

MP3 is a form of compression. It is an acronym which stands for MPEG Audio Layer 3. MP3 is a type of audio code which is processed by significant compression from the original audio source with very little loss in sound quality.

- This system supports MPEG-1/2 Audio Layer 3 (Sampling rates: 32 kHz to 48 kHz; Bit rates: 8 kbps to 320 kbps).
- During VBR file playback, time counter in the display may differ from its actual playback time.
- The folder and file order information which is recorded on the media depends on the writing software. There may be possibilities that this unit will playback the files not according to our expected playback order.
- From a media with MP3 files up to 255 folders and 999 files (including non playable files) can be read.

 **Note**

- This unit does not support multisession discs or multiborder recording.
- Multisession/multiborder recording is a method in which data is recorded on a single disc in two or more sessions/borders. A "session" or "border" is one recording unit, consisting of a complete set of data from lead-in to lead-out.

Regarding copy protected CDs

This unit is designed to conform to the specifications of the audio CD format. This unit does not support the playback or function of discs that do not conform to these specifications.

Supported audio file formats

This unit does not support lossless encoding.

Cautions on use**When moving this unit**

When moving this unit, be sure to first check that there is no disc loaded and disconnect the USB storage device. Then press , wait for "STAND BY" disappears on main display to turn off, then unplug the power cord. Damage may occur if the unit is transported or moved with a disc inserted, or when another device is connected to the USB terminal, or AUDIO IN mini-plug jack.

Place of installation

- Choose a stable place near the TV or stereo system being used with this unit.
- Do not place this unit on top of a TV or color monitor. Also install it away from cassette decks and other devices easily affected by magnetic forces.

Avoid the following locations:

- Places exposed to direct sunlight
- Humid or poorly ventilated places
- Extremely hot places
- Places exposed to vibrations
- Places in which there is much dust or cigarette smoke
- Places exposed to soot, steam or heat (kitchens, etc.)

Do not place objects on this unit

Do not place any objects on top of this unit.

Do not obstruct the ventilation holes.

Do not use this unit on shaggy rugs, beds, sofas, etc., or wrapped in cloth, etc. Doing so will prevent the heat from dispersing, leading to damage.

Do not expose to heat.

Do not place this unit on top of an amplifier or other component that generates heat. When rack mounting it, to avoid the heat given off by the amplifier or other audio component, place it on a shelf below the amplifier.

- Turn off the unit's power when not using it.
- Depending on signal conditions, striped patterns may appear on a TV screen and noise may enter the sound of radio broadcasts when the unit's power is on. If this happens, turn the unit's power off.

About condensation

If this unit is moved suddenly from a cold place into a warm room (in winter, for example) or if the temperature in the room in which this unit is installed rises suddenly due to heater operation, etc., water droplets (condensation) may form inside (on operating parts and the lens). When condensation is present, this unit will not operate properly and playback is not possible. Let this unit stand at room temperature for 1 or 2 hours with the power turned on (the time depends on the extent of condensation). The water droplets will dissipate and playback will become possible. Condensation can also occur in the summer if this unit is directly exposed to the air flow from an air-conditioner. If this happens, move this unit to a different place.

Cleaning the product

- Unplug the power cord from the power outlet when cleaning this unit.
- Clean this unit using a soft cloth. For tough dirt, apply some neutral detergent diluted in 5 to 6 parts water to a soft cloth, wring out thoroughly, wipe off the dirt, then wipe again with a soft, dry cloth.
- Alcohol, thinner, benzene, insecticides, etc., could cause the print or paint to peel off. Also, leaving rubber or vinyl products in contact with this unit for long periods of time could mar the cabinet.
- When using chemical-impregnated wipes, etc., read the cautions included with the wipes carefully.

Cleaning the lens

This unit's lens should not become dirty in normal use, but if for some reason it should malfunction due to dust or dirt, consult your nearest Pioneer authorized service center. Although lens cleaners for players are commercially available, we advise against using them since some may damage the lens.

Handling discs

Storing

- Always place discs in their cases and store them vertically, avoiding hot, humid places, places exposed to direct sunlight and extremely cold places.
- Be sure to read the cautions included with the disc.

Cleaning discs

- Discs may not play if there are fingerprints or dust on them. In this case, use a cleaning cloth, etc., to gently wipe the disc from the inside towards the outside. Do not use dirty cleaning cloths.



- Do not use benzene, thinner or other volatile chemicals. Also do not use record spray or antistatic agents.
- For tough dirt, apply some water to a soft cloth, wring out thoroughly, wipe off the dirt, then wipe off the moisture with a dry cloth.
- Do not use damaged (cracked or warped) discs.
- Do not let the signal surface of discs get scratched or dirty.

- Do not attach pieces of paper or stickers to discs. Doing so could warp discs, making it impossible to play them. Also note that rental discs often have labels attached to them, and the label's glue may have oozed out. Check that there is no glue around the edges of such labels before using rented discs.

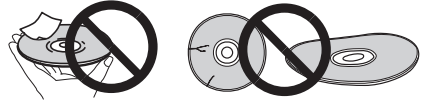

About specially shaped discs

Specially shaped discs (heart-shaped, hexagonal, etc.) cannot be played on this unit. Do not attempt to play such discs, as they could damage this unit.



Auto power off setting

1 Press MENU on the remote control.

"Auto Power Down" will be displayed on the main display.

2 Press ENTER on the remote control.

3 Press ▲/▼ to switch auto power off setting ON/OFF.

- Initial setting is set to ON.



Note

- When the auto power off is set to ON, "APD ON" will be displayed on the main display.
- When the auto power off is set to OFF, "APD OFF" will be displayed on the main display.

Restoring all the settings to the defaults

Use the steps below to restore the all settings to their defaults.

1 Press to turn the power on.

2 Press MENU and then press ▲/▼ until "Factory Reset" appears on the display.

3 Press ENTER.

"OK?" will appear.

4 Press ENTER.

- "Resetting" is displayed while the settings are being restored. Power is turned off.

Specifications

• Amplifier section

RMS Power Output: 15 W + 15 W
(1 kHz, 10 %, T.H.D., 8 Ω)

• Tuner section

Frequency Range (FM) 87.5 MHz to 108 MHz
Antenna Input (FM) 75 Ω unbalanced
Frequency Range (AM)
(For European models) 522 kHz to 1620 kHz
(For the U.S.A. and Canada models) 530 kHz to 1710 kHz
Antenna (AM) Loop antenna

• Bluetooth

Version Bluetooth Specification Ver. 4.1
Output Bluetooth Specification Class 2
Estimated line-of-sight transmission distance* About 10 m
Frequency range 2.4 GHz
Modulation FH-SS (Frequency Hopping Spread Spectrum)
Supported Bluetooth profiles A2DP, AVRCP
Supported Codec SBC (Subband Codec)
Supported contents protection SCMS-T
PIN code 0000

* The line-of-sight transmission distance is an estimate.
Actual transmission distances supported may differ depending on surrounding conditions.

• Miscellaneous

USB terminal 5 V, 500 mA
Power source
(For European models) AC 220 V to 240 V, 50 Hz/60 Hz
(For the U.S.A. and Canada models) AC 120 V, 60 Hz
Power consumption
Power on 20 W
Power stand-by 0.5 W or less
Power stand-by (BT STANDBY ON) 0.5 W or less
Dimensions 200 mm (W) x 129 mm (H) x 237 mm (D)
Weight (without package) 2.3 kg

• Speaker

Enclosure Bass-reflex, book-shelf type
(Magnetically shielded)
Configuration 2-way
Tweeter 5 cm cone
Woofers 9.4 cm cone
Maximum input power 15 W
Impedance 8 Ω
Dimensions 129 mm (W) x 200 mm (H) x 213 mm (D)
Weight 1.7 kg/each

• Accessories

Remote control 1
AAA batteries (R03) 2
AM antenna cable*1 1
FM wire antenna*1 1
DAB/FM wire antenna*2 1
Non-skid pads 12
Power cord 1
Speaker wire 2
Warranty card*3 1
Operating instructions (This document) 1

*1 X-CM56 only
*2 X-CM56D only
*3 European models only

Note

- The specifications are applicable when the power supply is 230 V.
- Specifications and the design are subject to possible modifications without notice, due to improvements.

"Pioneer" is a trademark of Pioneer Corporation, and is used under license.

© 2016 Onkyo & Pioneer Corporation.
All rights reserved.

Pioneer

2-3-12 Yaesu, Chuo-ku, Tokyo 104-0028 JAPAN

<U.S.A.>

18 PARK WAY, UPPER SADDLE RIVER, NEW JERSEY 07458, U.S.A.

Tel: 1-201-785-2600 Tel: 1-844-679-5350

<Germany>

Hanns-Martin-Schleyer-Straße. 35, 47877 Willich, Germany

Tel: +49(0)2154 913222

<UK>

Anteros Building, Odyssey Business Park, West End Road, South Ruislip, Middlesex, HA4 6QQ United Kingdom

Tel: +44(0)208 836 3612

<France>

6, Avenue de Marais F - 95816 Argenteuil Cedex FRANCE

Tel :+33(0)969 368 050

Корпорация О энд Пи

2-3-12, Яэсу, Чуо-ку, г. Токио, 104-0028, ЯПОНИЯ

© 2016 Onkyo & Pioneer Corporation. All rights reserved.

© 2016 Onkyo & Pioneer Corporation. Tous droits de reproduction et de traduction réservés.

Printed in China / Imprimé en Chine / Напечатано в Китае

SN 29402593A

F1611-1



YOM200173-0001