

VEVOR[®]

TOUGH TOOLS, HALF PRICE

Technical Support and E-Warranty Certificate www.vevor.com/support

WEDDING ARCH BACKDROP STAND

USER MANUAL

We continue to be committed to provide you tools with competitive price.

"Save Half", "Half Price" or any other similar expressions used by us only represents an estimate of savings you might benefit from buying certain tools with us compared to the major top brands and does not necessarily mean to cover all categories of tools offered by us. You are kindly reminded to verify carefully when you are placing an order with us if you are actually saving half in comparison with the top major brands.

VEVOR®

TOUGH TOOLS, HALF PRICE

WEDDING ARCH
BACKDROP STAND

Model: TFHQGM87266FT



NEED HELP? CONTACT US!

Have product questions? Need technical support? Please feel free to contact us:
Technical Support and E-Warranty Certificate www.vevor.com/support

This is the original instruction, please read all manual instructions carefully before operating. VEVOR reserves a clear interpretation of our user manual. The appearance of the product shall be subject to the product you received. Please forgive us that we won't inform you again if there are any technology or software updates on our product.

INSTRUCTIONS

Thank you very much for choosing this product. Please read all the instructions before using it. The information will help you achieve the best possible results.

PLEASE NOTE! Drawings in this manual are for illustration purposes only and in some details may differ from the actual product.

ATTENTION! Read all safety warnings and all instructions. The device or product used in the warning instructions is referred to wedding arch backdrop stand.

This product is not a toy or a toy chest. Do not allow children to play with this item. Please place in a position that children cannot climb to avoid injury from falling from a height.

USAGE SAFETY

1. Before installation, please make sure that the parts in the manual are in the packaging box. If you find parts missing, please contact your seller first.
2. Select an area for assembly that is clean and free of any debris that might cause persons working on the assembly to trip.
3. Preview the assembly instructions in your operator's manual before proceeding further.
4. After completing assembly, thoroughly inspect the machine to be sure that all nuts, bolts assemblies have been thoroughly tightened.
5. This product is not a climbing frame or hanging tool, and should not be used for use other than wedding arch backdrop stand.
6. Parts not separately marked "x FT" in the parts list are general parts of different size brackets and can be installed according to the instructions.









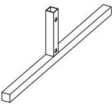

SAVE THESE INSTRUCTIONS

SPECIFICATIONS







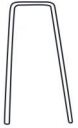

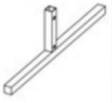

Model	TFHQGM87266FT
Color	gold
Product size	8*4.6ft, 7.2*4ft, 6.6*3.3ft

PARTS LIST









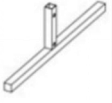

8ft

						
A×2PCS	B×8PCS	8FT C×1PC	8FT D×2PCS	8FT E×1PC	8FT F×2PCS	8FT G×3PCS
						
8FT H×1PC	I×18PCS	J×2PCS	K×1PC	M×4PCS		

7.2ft

						
A×2PCS	B×8PCS	7.2FT C×1PC	7.2FT D×1PC	7.2FT E×1PC	7.2FT F×2PCS	7.2FT G×1PC
						
I×16PCS	J×2PCS	7.2FT L×2PCS	M×4PCS			

6.6ft

						
A×2PCS	B×8PCS	7.2FT C×1PC	7.2FT D×1PC	7.2FT E×1PC	7.2FT F×2PCS	7.2FT G×1PC
						
I×16PCS	J×2PCS	7.2FT L×2PCS	M×4PCS			

PRODUCT ASSEMBLY

8ft

Step 1: Assemble Part "8FT F", "8FT G" & "8FT H" as shown using hardware I.

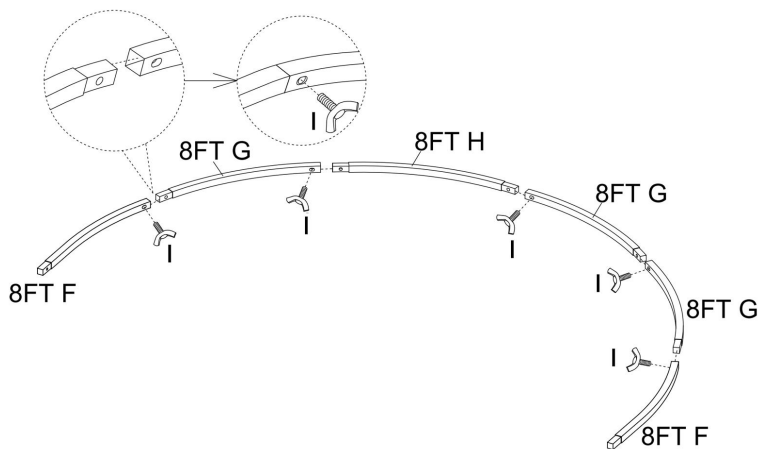

Step 2: Assemble Part B as shown using hardware I.

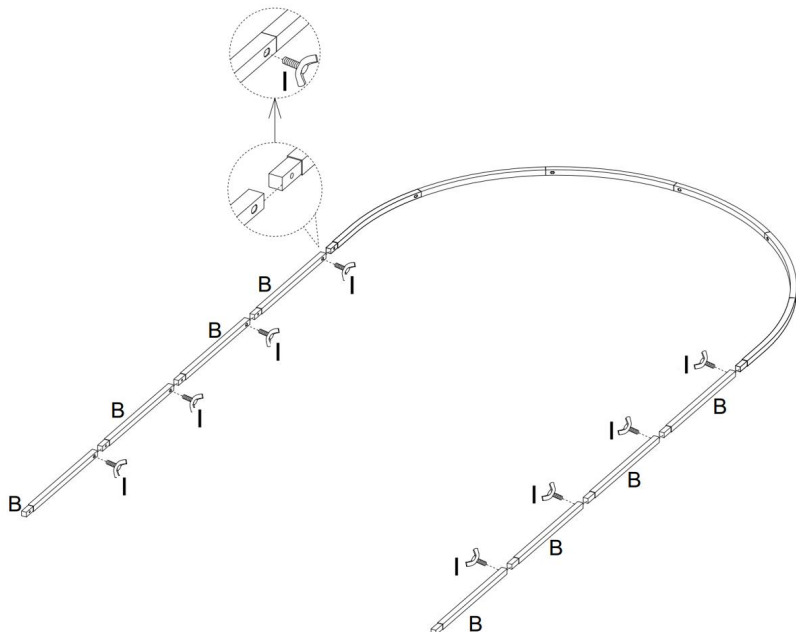

Step 3: Assemble Part A as shown using hardware I.

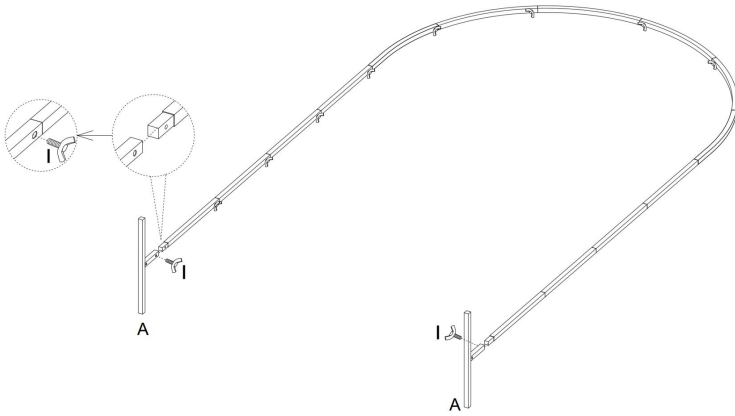

Step 4: Assemble Part "8FT C" , "8FT D" & "8FT E" as shown using hardware I. Then use part J to install them onto the frame you completed in the previous step. The position of the assembled part I on the component before locking part J can be adjusted according to your needs.



7.2ft

Step 1: Assemble Part "7.2FT F", "7.2FT G" & "7.2FT L" as shown using hardware I.

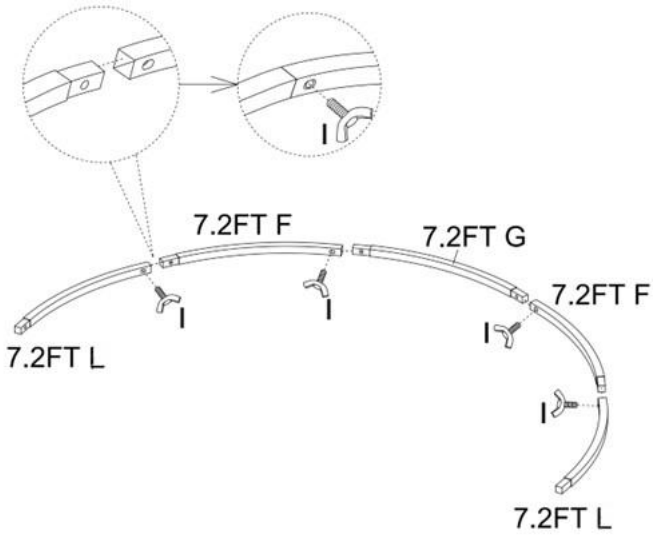

Step 2: Assemble Part B as shown using hardware I.

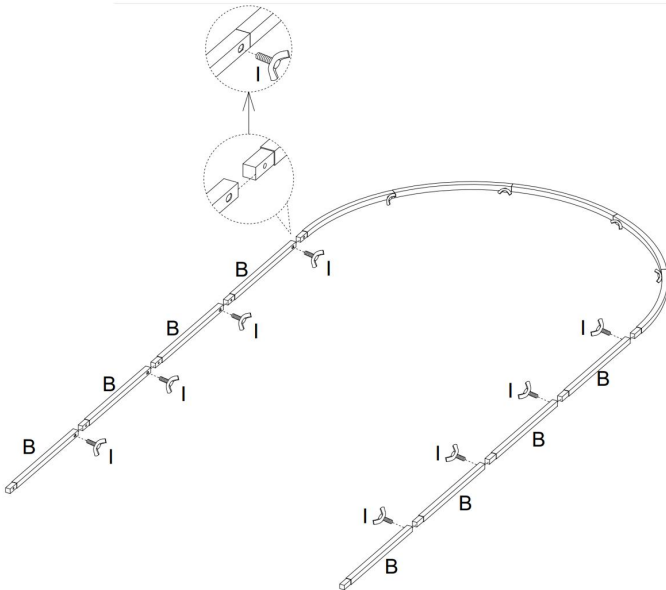

Step 3: Assemble Part A as shown using hardware I.

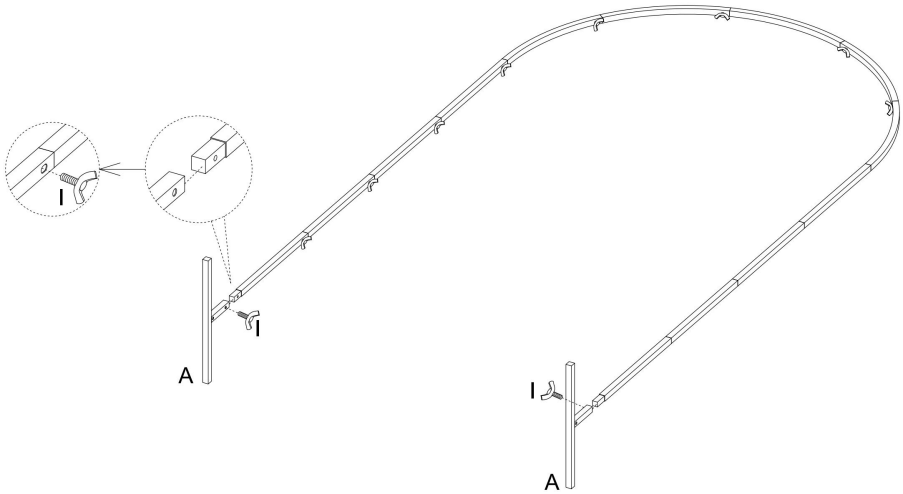

Step 4: Assemble Part “7.2FT C” , “7.2FT D” & “7.2FT E” as shown using hardware I. Then use part J to install them onto the frame you completed in the previous step. The position of the assembled part I on the component before locking part J can be adjusted according to your needs.

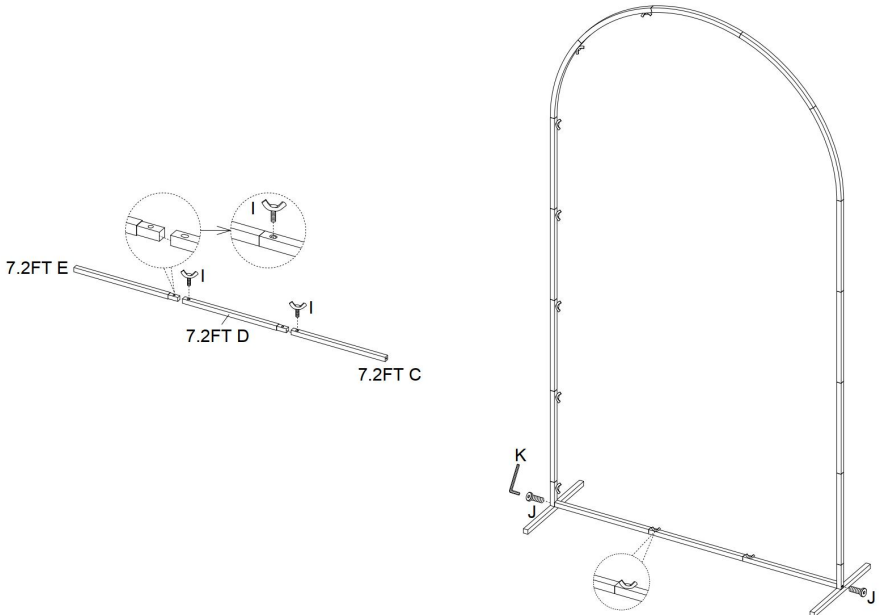

6.6ft

Step 1: Assemble Part "6.6FT F", "6.6FT G" & "6.6FT H" as shown using hardware I.

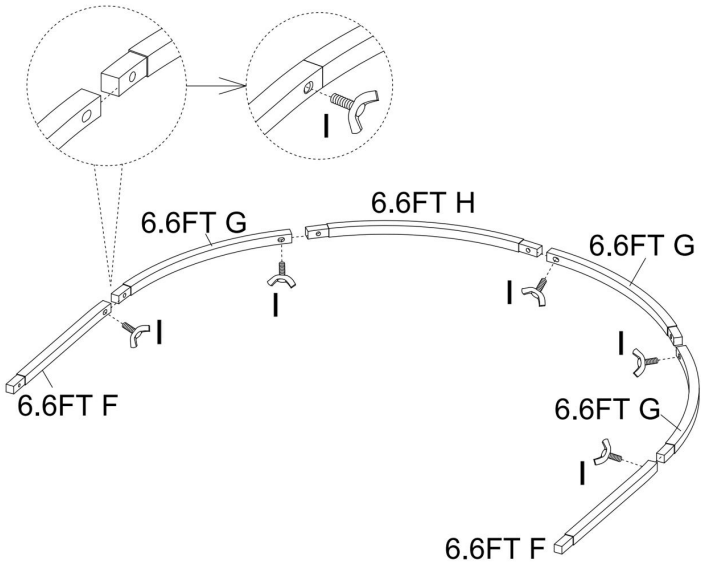

Step 2: Assemble Part B as shown using hardware I.

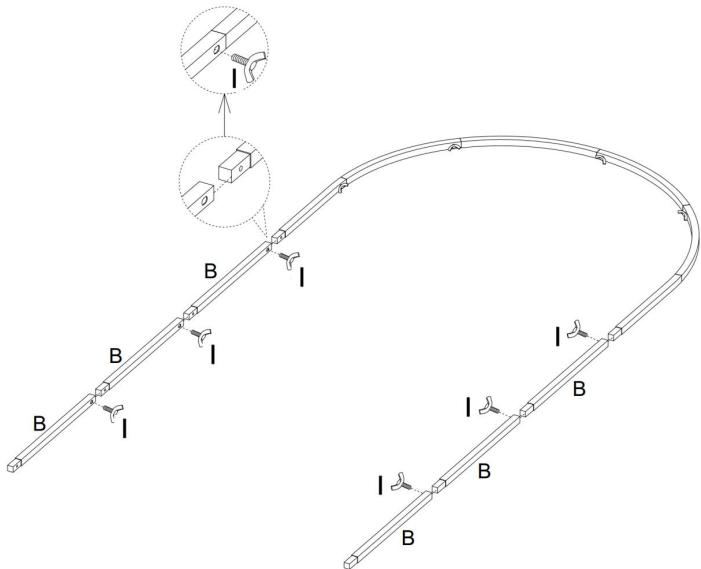

Step 3: Assemble Part A as shown using hardware I.

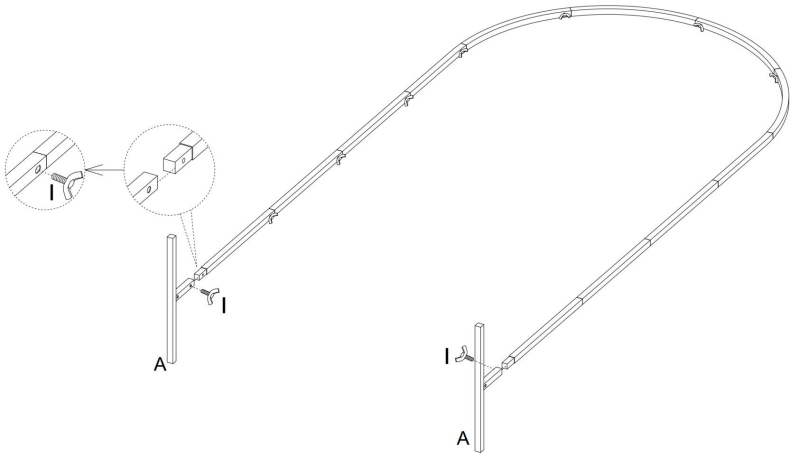

Step 4: Assemble Part "6.6FT C" , "6.6FT D" & "6.6FT E" as shown using hardware I. Then use part J to install them onto the frame you completed in the previous step. The position of the assembled part I on the component before locking part J can be adjusted according to your needs.

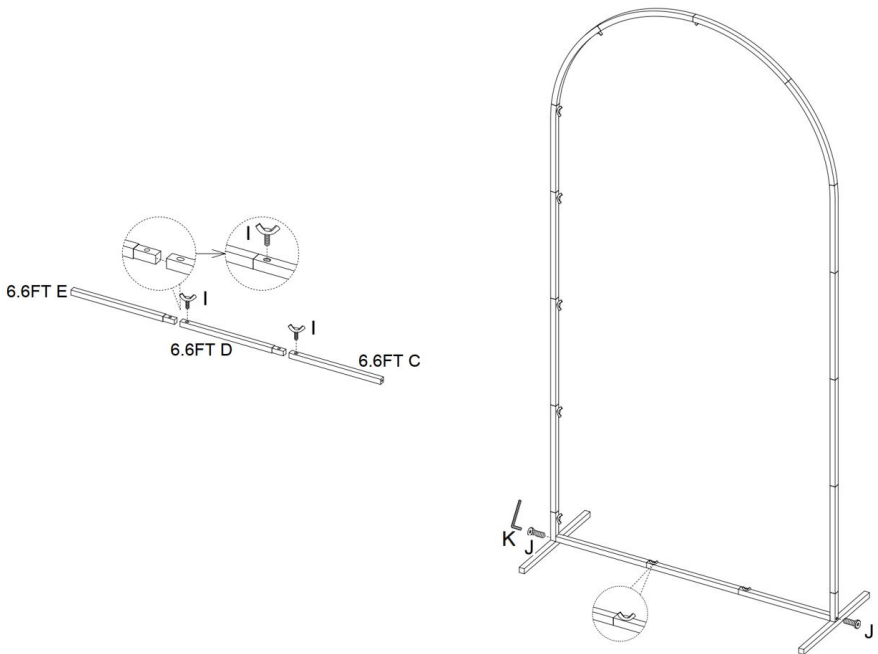

If the arch backdrop stand is installed on soft ground similar to grass, it can be reinforced with part "M".

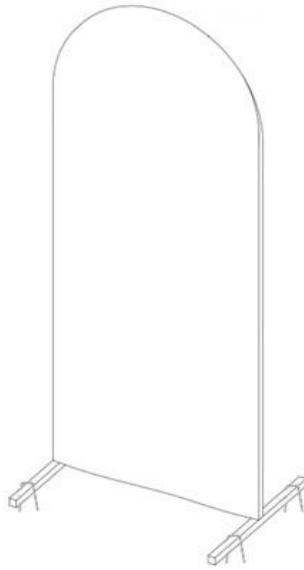

Manufacturer:Shanghaimuxinmuyeyouxiangongsi

Address: Shuangchenglu 803nong11hao1602A-1609shi, baoshanqu, shanghai 200000 CN.

Imported to AUS: SIHAO PTY LTD. 1 ROKEVA STREETEASTWOOD NSW 2122 Australia

Imported to USA: Sanven Technology Ltd. Suite 250, 9166 Anaheim Place, Rancho Cucamonga, CA 91730

EC	REP
-----------	------------

E-CrossStu GmbH
Mainzer Landstr.69, 60329 Frankfurt am Main.

UK	REP
-----------	------------

YH CONSULTING LIMITED.
C/O YH Consulting Limited Office 147, Centurion House,
London Road, Staines-upon-Thames, Surrey, TW18 4AX

VEVOR[®]

TOUGH TOOLS, HALF PRICE

Technical Support and E-Warranty Certificate

www.vevor.com/support