

ONKYO®

Dock Music System

RBX-500

Instruction Manual

Contents

Introduction En-2

Connections En-7

Enjoying Audio Sources
..... En-11

Appendix
Troubleshooting En-14
Specifications En-15

Thank you for purchasing an Onkyo Dock Music System. Please read this manual thoroughly before making connections and plugging in the unit.

Following the instructions in this manual will enable you to obtain optimum performance and listening enjoyment from your Speaker.

Please retain this manual for future reference.





CAUTION
RISK OF ELECTRIC SHOCK
DO NOT OPEN



The lightning flash with arrowhead symbol, within an equilateral triangle is intended to alert the user to the presence of uninsulated "dangerous voltage" within the product's enclosure that may be of sufficient magnitude to constitute a risk of electric shock to persons.



The exclamation point within an equilateral triangle is intended to alert the user to the presence of important operating and maintenance (servicing) instructions in the literature accompanying the appliance.

WARNING:

TO REDUCE THE RISK OF FIRE OR ELECTRIC SHOCK, DO NOT EXPOSE THIS APPLIANCE TO RAIN OR MOISTURE.

DO NOT REMOVE COVER or OPEN THE CABINET.

Dangerous high voltages are present inside the enclosure. No user serviceable parts inside. Leave all servicing to qualified service personnel.

Important Safety Instructions

1. Read these instructions.
2. Keep these Instructions.
3. Heed all Warnings.
4. Follow all instructions.
5. Do not use this apparatus near water.
6. Clean only with dry cloth.
7. Do not block any ventilation openings. Install in accordance with the manufacturer's instructions.
8. Do not install near any heat sources such as radiators, heat registers, stoves, or other apparatus (including amplifiers) that produce heat.
9. Do not defeat the safety purpose of the polarized or grounding - type plug. A polarized plug has two blades with one wider than the other. A grounding type plug has two blades and a third grounding prong. The wide blade or the third prong is provided for your safety. If the provided plug does not fit into your outlet, consult an electrician for replacement of the obsolete outlet.
10. Protect the power cord from being walked on or pinched particularly at plugs, convenience receptacles, and the point where they exit from the apparatus.
11. Only use attachments/accessories specified by the manufacturer.
12. Use only with the cart, stand, tripod, bracket or table specified by the manufacturer, or sold with the apparatus. When a cart is used, use caution when moving the cart/apparatus combination to avoid injury from tip-over.
13. Unplug this apparatus during lightning storms or when unused for long periods of time.
14. Refer all servicing to qualified service personnel. Servicing is required when the apparatus has been damaged in any way, such as power-supply cord or plug is damaged, liquid has been spilled or objects have fallen into the apparatus, the apparatus has been exposed to rain or moisture, does not operate normally, or has been dropped.
15. Apparatus shall not be exposed to dripping or splashing and no objects filled with liquids, such as vase, shall not be placed on the apparatus.
16. The mains plug is used as disconnect device and it shall remain readily operable during intended use. In order to disconnect the mains plug from the mains completely, the mains plug should be disconnected from the mains socket outlet completely.
17. The batteries (battery pack & batteries installed) shall not be exposed to excessive heat such as sunshine, fire or the like.
18. Do not place any naked flame sources, such as lighted candles, on the apparatus.
19. The battery used in this product must be properly recycled or disposed of. Please contact your local recycling center for proper battery handling and disposal instructions.



PORTABLE CART WARNING
(Symbol provided by RETAC)

Precautions

- 1. Recording Copyright**—Unless it's for personal use only, recording copyrighted material is illegal without the permission of the copyright holder.
- 2. AC Fuse**—The AC fuse inside the unit is not user-serviceable. If you cannot turn on the unit, contact your Onkyo dealer.
- 3. Care**—Occasionally you should dust the unit all over with a soft cloth. For stubborn stains, use a soft cloth dampened with a weak solution of mild detergent and water. Dry the unit immediately afterwards with a clean cloth. Don't use abrasive cloths, thinners, alcohol, or other chemical solvents, because they may damage the finish or remove the panel lettering.

4. Power WARNING

BEFORE PLUGGING IN THE UNIT FOR THE FIRST TIME, READ THE FOLLOWING SECTION CAREFULLY.

AC outlet voltages vary from country to country. Make sure that the voltage in your area meets the voltage requirements printed on the unit's rear panel (e.g., AC 230 V, 50 Hz or AC 120 V, 60 Hz).

The power cord plug is used to disconnect this unit from the AC power source. Make sure that the plug is readily operable (easily accessible) at all times.

For models with [POWER] button, or with both [POWER] and [ON/STANDBY] buttons: Pressing the [POWER] button to select OFF mode does not fully disconnect from the mains.

If you do not intend to use the unit for an extended period, remove the power cord from the AC outlet.

For models with [ON/STANDBY] button only: Pressing the [ON/STANDBY] button to select Standby mode does not fully disconnect from the mains.

If you do not intend to use the unit for an extended period, remove the power cord from the AC outlet.

5. Preventing Hearing Loss

Caution

Excessive sound pressure from earphones and headphones can cause hearing loss.

6. Batteries and Heat Exposure

Warning

Batteries (battery pack or batteries installed)

shall not be exposed to excessive heat as sunshine, fire or the like.

- 7. Never Touch this Unit with Wet Hands**—Never handle this unit or its power cord while your hands are wet or damp. If water or any other liquid gets inside this unit, have it checked by your Onkyo dealer.
- 8. Handling Notes**

- If you need to transport this unit, use the original packaging to pack it how it was when you originally bought it.
- Do not leave rubber or plastic items on this unit for a long time, because they may leave marks on the case.
- This unit's top and rear panels may get warm after prolonged use. This is normal.
- If you do not use this unit for a long time, it may not work properly the next time you turn it on, so be sure to use it occasionally.

For European Models

Declaration of Conformity	
We, ONKYO EUROPE ELECTRONICS GmbH LIEGNITZERSTRASSE 6, 82194 GROEBENZELL, GERMANY	
declare in own responsibility, that the ONKYO product described in this instruction manual is in compliance with the corresponding technical standards such as EN60065, EN55013, EN55020 and EN61000-3-2, -3-3.	
GROEBENZELL, GERMANY	 K. MIYAGI
ONKYO EUROPE ELECTRONICS GmbH	

For British models

Replacement and mounting of an AC plug on the power supply cord of this unit should be performed only by qualified service personnel.

IMPORTANT

The wires in the mains lead are coloured in accordance with the following code:

Blue: Neutral
Brown: Live

As the colours of the wires in the mains lead of this apparatus may not correspond with the coloured markings identifying the terminals in your plug, proceed as follows:

The wire which is coloured blue must be connected to the terminal which is marked with the letter N or coloured black.

The wire which is coloured brown must be connected to the terminal which is marked with the letter L or coloured red.

IMPORTANT

The plug is fitted with an appropriate fuse. If the fuse needs to be replaced, the replacement fuse must be approved by ASTA or BSI to BS1362 and have the same ampere rating as that indicated on the plug. Check for the ASTA mark or the BSI mark on the body of the fuse.

If the power cord's plug is not suitable for your socket outlets, cut it off and fit a suitable plug. Fit a suitable fuse in the plug.

Features

- Sonic Emotion** ^{*1} **Absolute 3D Sound Technology**
- Down-firing Powerful Subwoofer**
- Bluetooth** ^{*2} **Audio Playback (ver.2.1 + EDR)**
- iPod/iPhone** ^{*3} **Dock**

*1

Sonic Emotion and  are registered trademarks of sonic emotion ag.

Sonic Emotion® Absolute 3D is the listening experience. Absolute 3D uses sound field control to transform the listener's room to a virtually created natural sound field.

With wave field synthesis being the foundation of sound field control, sound waves are produced and dispersed throughout the entire listening area ensuring all listeners to be amazed in an all enveloping 3D sound with rich depths and spacious sounds regardless of the listeners' position. Exactly as in a natural environment, sounds are heard from all around regardless of the device location.

*2



The Bluetooth word mark and Bluetooth logo are all trademarks that are owned by the Bluetooth SIG and licensed out for use to Onkyo. that are incorporating Bluetooth wireless technology into their products. QDID : B019744

*3



iPhone, iPod, iPod classic, iPod nano, iPod shuffle, and iPod touch are trademarks of Apple Inc., registered in the U.S. and other countries.

"Made for iPod" and "Made for iPhone" mean that an electronic accessory has been designed to connect specifically to iPod or iPhone, respectively, and has been certified by the developer to meet Apple performance standards.

Apple is not responsible for the operation of this device or its compliance with safety and regulatory standards.

Please note that the use of this accessory with iPod or iPhone may affect wireless performance.

Contents

Important Safety Instructions	2
Precautions	3
Features	4
Supplied Accessories	5
Main unit	7
Top panel and front panel.....	7
Rear Panel.....	7
Remote controller	9
Power ON/ OFF the main unit.....	10
Power on the main unit.....	10
Power off the main unit	10
Auto standby feature	10
Alarm function of iPod	10
Play music	11
Connect iPod/iPhone with the dock and play music	11
Play music through wireless (Bluetooth) .	12
Connect with LINE IN terminal and play music.....	13
Troubleshooting.....	14
Troubleshooting	14
Reset.....	14
Specifications	15

Supplied Accessories

Make sure you have the following accessories:



Remote controller (RC-847S)

A lithium battery (CR2025) is loaded in the remote controller.

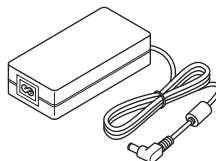

AC adapter

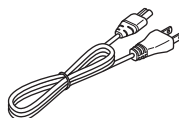

Plug type varies from country to country.

Power cord

* In catalogs and on packaging, the letter at the end of the product name indicates the color. Specifications and operation are the same regardless of color.

How to use Remote controller

Remove the insulation sheet before use.

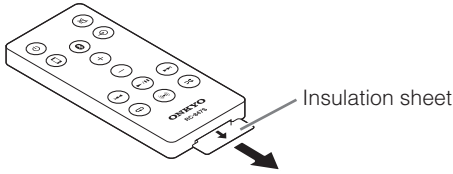

When using the remote controller, point it toward the remote control sensor, as shown below.

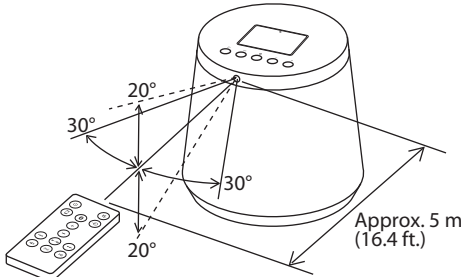

Notes:

- If the light receiving area is exposed to strong light such as direct sunlight or inverter fluorescent, the remote controller may not work.
- If another infrared device is nearby or another remote controller is used at the same time, the remote controller may not work correctly.

Place for installation

Use in a place exposed to direct sunlight or a sterilization lamp may cause discoloration by influence of ultraviolet rays.

To enjoy the 3D sound effect, it is recommended to install the unit in a free and open area.

Battery change

In replacing the battery, ensure to use the specified model.

- 1 **With pushing the stopper in sideways, pull out the battery holder.**

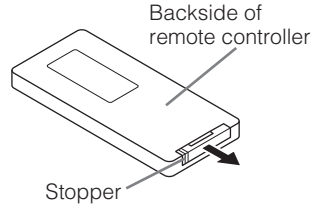

- 2 **Place a lithium battery on the battery holder, and return the holder into the remote control until it clicks.**

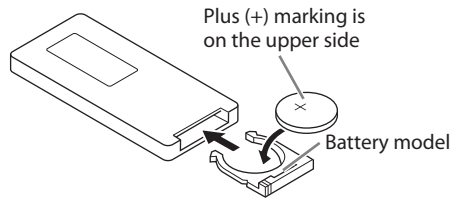

Notes:

- Specified battery model must be used; otherwise you have a risk of a burst.
- A battery must be kept away from children. In case a child swallows a battery, consult a physician immediately.
- Do not attempt to recharge, short-circuit, disassemble, heat the battery, or put it in fire. It may cause overheat, burst or fire.
- If you do not use the remote controller for a long time, remove the battery from it to avoid a damage caused by a fluid leak or corrosion.

Main unit

Top panel and front panel

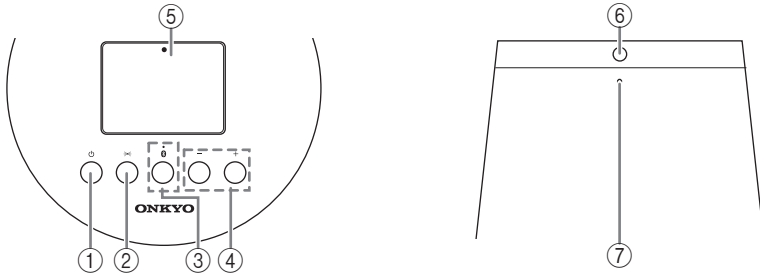

For detailed information, see the pages in parentheses.

① **Power button**

Switches ON/Standby of the power alternately.
When the power is ON, the power indicator lights up in white color.

② **3D SOUND button**

Switches 3D sound effect in the order shown below:

→NORMAL → ENHANCE → VOCAL→

③ **Bluetooth button, Bluetooth indicator**
(→ page 12)

Activates Bluetooth input, switches Bluetooth ON/OFF or activates Bluetooth pairing mode.

④ **VOLUME +/- button**

Controls sound volume. White operation indicator flashes during operation, and flashing stops when volume reaches minimum or maximum.

⑤ **iPod/iPhone dock** (→ page 11)

Connects with iPod or iPhone.

⑥ **Light receiving area for remote controller**

⑦ **Power/ Operation indicator**

White: Power ON, White (dark): Charging iPod/iPhone (Standby), Off: Standby

Orange: Bluetooth standby

During the power is ON, when each button is pressed, white indicator turns off for a short time (flashes in case of VOLUME +/- button). As

for 3D SOUND button, indicator flashes as follows:
NORMAL: Flashes once ENHANCE: Flashes 2 times VOCAL: Flashes 3 times

Rear Panel

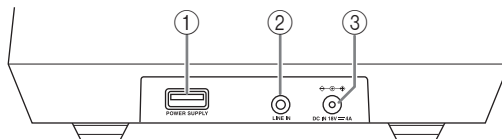

For detailed information, see the pages in parentheses.

① **POWER SUPPLY terminal** (→ page 8)

USB Power terminal (5 V/ 2.1 A).

This terminal is only for power supply; it cannot be used for playing sound.

② **LINE IN terminal** (→ page 13)

Connected with a sound output of an external device with a commercially-available stereo mini-plug audio cable.

③ **DC IN terminal** (→ page 8)

Connected with the attached AC adapter.

Connect AC adapter

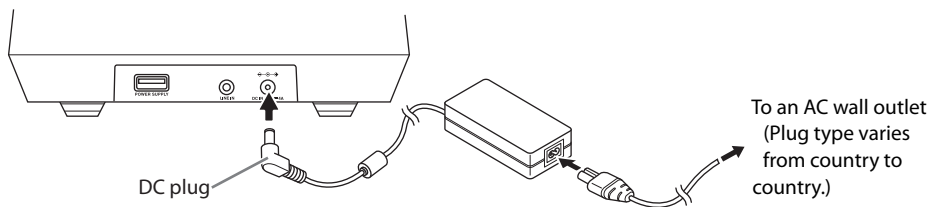

- 1** Insert the DC plug of AC adapter into the DC IN jack of the main unit.
- 2** Connect the Power cord with the AC adapter, then insert the power connector into an outlet.

Notes:

Do not use any other AC adapter than the attached one, and do not use the attached AC adapter with other devices. Otherwise, it may cause malfunction or other problems.

USB Power terminal

USB terminal on the back side of the main unit is for power. It supplies 5 V/ 2.1 A, but does not guarantee charging for all devices.

The dock on the top panel has priority. When iPod or iPhone is connected with the dock, this USB terminal is not powered.

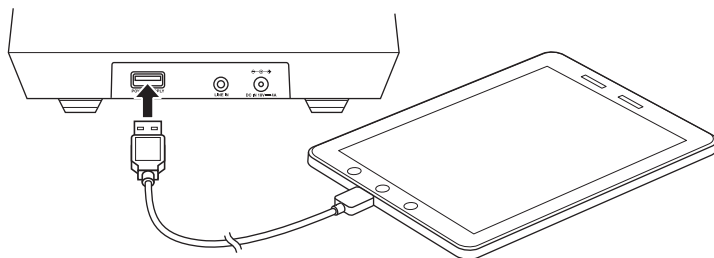

Connection cable is not included. A cable included in the connected device or a suitable commercially-available cable should be used.

Notes:

Do not use this terminal for any other use than battery charge. You cannot connect a USB device to this terminal.

Remote controller

Buttons

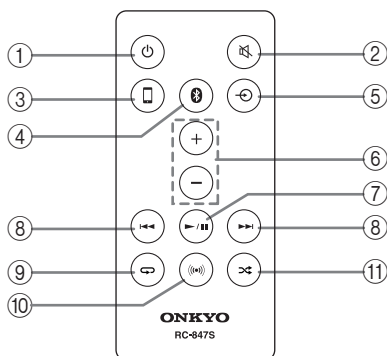

For detailed information, see the pages in parentheses.

- ① **⏻ (POWER) button**
Switches ON/Standby of the power alternately. When the power is ON, the power indicator lights up in white color.
- ② **🔇 (MUTING) button**
Mutes sound. During the muting mode, the power indicator flashes in white color.
Pressing 🔇 again or the VOLUME +/- button cancels the muting mode.
- ③ **📱 (iPod) button (→ page 11)**
Changes input mode to iPod/iPhone dock.
- ④ **📶 (BLUETOOTH) button (→ page 12)**
Activates Bluetooth input, switches Bluetooth ON/OFF or activates Bluetooth pairing mode.
- ⑤ **🔄 (LINE button) button (→ page 13)**
Changes the input mode to LINE.
- ⑥ **VOLUME +/- button**
Controls sound volume. White operation indicator flashes during operation, and flashing stops when volume reaches minimum or maximum.
- ⑦ **▶/⏸ button**
Play/ pause iPod/iPhone connected with the dock, or a device connected through Bluetooth.
- ⑧ **⏮/▶▶ button**
Selects the next or the previous track of iPod/iPhone connected with the dock or a device connected through Bluetooth. During play, pressing the ⏮ button is for returning to

the beginning of the current track, and pressing the ⏮ button twice is for returning to the previous track.

- ⑨ **🔄 (REPEAT) button**
Switches the REPEAT modes of iPod/iPhone connected with the dock.
- ⑩ **🔊 (3D SOUND) button**
Switches 3D sound effect in the order shown below:

◀ NORMAL → ENHANCE → VOCAL ▶
- ⑪ **🔀 (SHUFFLE) button**
Switches the SHUFFLE modes of iPod/iPhone connected with the dock.

Power ON/ OFF the main unit

Power on the main unit

- 1 Press  (Power button) either on the main unit or on the remote controller.

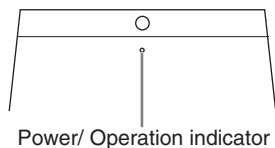
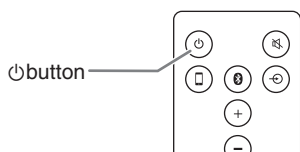
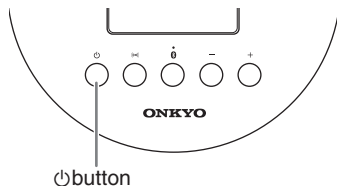

When the power is ON, power indicator lights up in white.

Power off the main unit

- 2 Press  (Power button) either on the main unit or on the remote controller.

The main unit turns to the standby state, and the power indicator light off.

When iPod/iPhone is connected to the dock, the indicator light is dim, whereas when the Bluetooth is in the Standby mode, the indicator lights up in orange.

Auto standby feature

For energy saving, the main unit will automatically turn to the standby mode in case of no input signal for 20 minutes.

Power on the unit for continuous use.

Alarm function of iPod

The iPod alarm sound can be played in this unit. When your iPod is equipped with alarm function, set an alarm and connect to the dock. After adjusting the sound volume to an optimum level, set the unit to Standby.

Caution:

Do not sit on the unit, or it could result in failure.

Play music

Connect iPod/iPhone with the dock and play music

Connect iPod/iPhone with the dock and play music

1 Open the lid of the dock.

Press the back end of the lid to raise the front end, and lift it.

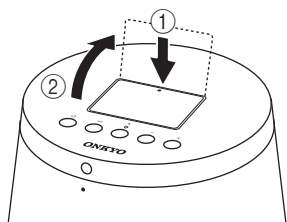

2 Connect iPod/iPhone with the dock.

Insert an iPod/iPhone in the connector of the dock firmly. When RBX-500 is in the standby mode, the power will automatically turn on.

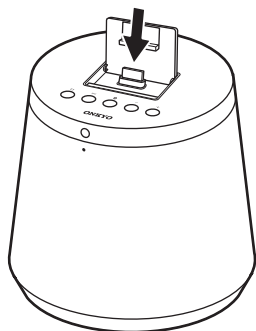

Notes:

When a case is attached to iPod/iPhone, the iPod/iPhone may not be able to be surely connected with the dock. This will cause problems such as no sound or no control. When this happens, remove the case before connection.

3 Press ►/II button on the remote controller.

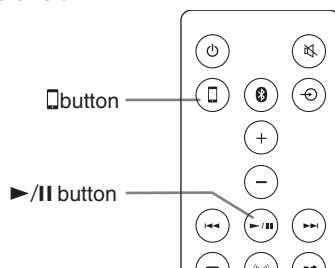

When input mode is iPod, you can control iPod/iPhone to play music.

Tips:

When an iPod/iPhone is connected to the dock, input mode is automatically changed to iPod. This also happens when you start playing music in iPod/iPhone; the input mode is automatically changed to iPod.

Compatibility of iPod/iPhone

This unit can work with the following iPod/iPhone;

- iPod touch (1st, 2nd, 3rd and 4th generation)
- iPod classic
- iPod nano (3rd, 4th, 5th and 6th generation)
- iPhone 4S, iPhone 4, iPhone 3GS, iPhone 3G and iPhone

Notes:

Be sure to use update iOS for iPod/iPhone. Please see detailed information of iOS at Apple website;

Charging

When an iPod/iPhone is connected with the dock, the iPod/iPhone is charged. During standby, the power indicator lights up darkly in white (in orange at Bluetooth standby).

In addition, when an iPod/iPhone is connected with the dock, USB terminal on the backside is powered off. If you want to use the power from USB terminal, remove an iPod/iPhone from the dock.

Play music through wireless (Bluetooth)

Pairing

For Bluetooth connection, a target Bluetooth device needs to be registered (called pairing) to the main unit in advance.

1 Place the main unit and a Bluetooth device in the distance within several meters, then power on each device.

2 Press  button either on the main unit or on the remote controller.

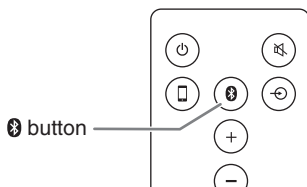
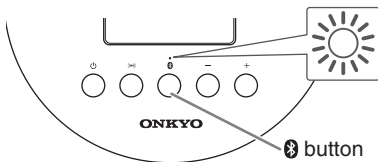

The main unit turns to pairing mode, and Bluetooth indicator (blue color) flashes fast.

3 Operate the Bluetooth device to make the registration of the device with reference to the operation manual of the Bluetooth device.



Tips:

- In case that the Bluetooth device displays a selection screen for registration, select "Onkyo RBX-500".
- In case that a passkey (also called password or PIN code) is required, input "0000".

After pairing is completed, the Bluetooth indicator of the main unit lights up in blue color.

If they are already connected each other, music can be played.



Notes:

- When the device registration is not completed within 2 minutes, the Bluetooth indicator turns to flash slowly. When this happens, press the  button on the main unit to turn off the Bluetooth once, and press the  button again to perform pairing.
- Because pairing information is stored, pairing is needed only one time per one Bluetooth device unless pairing information is deleted.
- The main unit can store pairing information for up to 8 devices. When pairing information is stored for 9th Bluetooth device, the oldest pairing information is deleted.

Play music in a Bluetooth device

The main unit and a Bluetooth device need to be connected through Bluetooth in advance. During Bluetooth connection, the Bluetooth indicator of the main unit lights up in blue and you can control to play music by wireless.

1 Press  button either on the main unit or the remote controller, or make a Bluetooth connection from a device.



When  button on the main unit is pressed, the main unit attempts to connect with the Bluetooth device that was connected previously for 5 seconds. When the connection is not established, make a Bluetooth connection from a device. Or, turn off a Bluetooth device by once pressing the  button, and press the  button again.

2 Operate a Bluetooth device to play music.

Notes:

In case that equalizer or bass booster of a Bluetooth device is activated, sound may be distorted.

Disconnecting Bluetooth

To disconnect a Bluetooth device from the unit, either press the  button on the main unit or ,  button on the remote controller. Turning off the power also disconnects the Bluetooth device.

Bluetooth standby

Bluetooth standby enables users to power on the main unit by attempting Bluetooth connection from a Bluetooth device.

- 1 **Make the main unit standby.**
- 2 **Press and hold  button either on the main unit or on the remote controller for 3 seconds or more.**

The unit turns to Bluetooth standby, and the power indicator lights up in orange.

When Bluetooth connection is made from a Bluetooth device, the main unit turns power on and music can be played.

Furthermore, when Bluetooth connection is disconnected from the Bluetooth device, the main unit turns power off in about 2 minutes.

When the Bluetooth device is in the Standby mode, the standby energy increases a little.

Canceling Bluetooth standby

Press and hold  button for 3 seconds or more during the Bluetooth standby state. The power indicator (orange) turns off, and returns to regular standby.

Connect with LINE IN terminal and play music

An external device can be connected and music can be played in the main unit.

- 1 **Make the main unit standby, and connect an external device with LINE IN terminal on the backside.**

Use a commercially-available cable suitable for the external device. The terminal of the main unit is stereo miniature jack.

- 2 **Press  button on the remote controller.**

- 3 **Operate the external device to play music.**

Notes:

In case of connection with the earphone jack of a device such as a digital audio player, sound volume may be too small. When this happens, control the device to turn up the sound volume.

Notes:

The Line-in terminal has been designed for connection from headphone output of a portable device. Accordingly, connecting the terminal with a device of high output voltage (1.5 V or more) could result in sound distortion.

When sound distortion occurs, turn down the volume if it is possible to turn down the volume on the connected device.

Troubleshooting

Troubleshooting

The main unit does not operate, or the operation is something wrong

- Unplug the power connector once, then insert the plug again after 10 seconds or more.
- Reset the main unit (→ page 14).



The main unit does not turn on

- Check the connection of AC adapter and Power cord (→ page 8).

The main unit turns off without any operation

- Auto standby feature may work (→ page 10).

No sound or sound is too small

- Input mode is not correct. Change input mode correctly by pressing ,  and  button on the remote controller (→ page 9).
- In case that the sound from the external device is too small through Bluetooth connection or LINE connection, control the external device to turn up the sound volume.

iPod/iPhone does not work

- If the case is attached to iPod/iPhone connected with the dock, remove the case.
- Check if your iPod/iPhone model is compatible with this product (→ page 11).
- If the operation stops suddenly, reset your iPod/iPhone.

The sound of iPod/iPhone is distorted

- Turn off equalizer or other enhanced sound functions of iPod/iPhone.
- Reset your iPod/iPhone. In case of a model corresponding to multitasking, quit all other applications.

Pairing of Bluetooth cannot be made

- Refer to the operation manual of the Bluetooth device.
- Turn off the power of this unit and a Bluetooth device once, and turn on the power again to try pairing again.
- Delete the registered data of "Onkyo RBX-500" at the Bluetooth device side again, and try pairing again.

Bluetooth connection cannot be made

- Check the Bluetooth device has been powered on and Bluetooth function is activated.

- Is the distance with the Bluetooth device adequate? Isn't the device blocked by a wall or something?

The sound through Bluetooth is interrupted

- Keep away from wireless LAN devices, other Bluetooth devices or a microwave oven.
- Put the Bluetooth device close to the main unit. Try changing the location of the Bluetooth device or the main unit.

The sound of Bluetooth is later than the image

- There is some signal delay because of characteristic of Bluetooth transmission. Therefore, audio delay to the image on Bluetooth device may occur.

A device cannot be charged with the USB terminal on the backside

- Remove your iPod/iPhone from the dock.

Remote controller does not work

- If batteries of the remote controller are exhausted, replace them with new ones (→ page 6).
- Ensure correct use of the remote controller (→ page 6).
- Do not expose the light receiving area to strong light such as direct sunlight or inverter fluorescent.

Reset

Reset the main unit with the following step:

1. Unplug the DC connector of the AC adapter, and wait for 10 seconds.
2. Insert the DC connector with depressing on the  button on the main unit for 2 seconds or more.
3. Wait until the power indicator lights up and then turns off.

Notes:

Resetting makes all the settings turn to the default conditions.

Because all the Bluetooth pairing information is erased, conduct pairing process again if necessary.

Specifications

■ General

Actual maximum output	5 W 6 ch, 4 Ω (Satellite) 10 W 1 ch, 4 Ω (Subwoofer) (THD+N 1% or less, 6.1ch Drive (Simultaneous drive))
Power source & voltage	AC 100 - 240 V, 50/60 Hz
Power consumption	30 W
Power consumption at no sound	20 W
Standby power	0.3 W
Maximum outer dimensions	220 mm(W) × 230 mm(H) × 220 mm(D)
Weight	3.4 kg
Analog input	LINE (1 line)

■ Amplifier

Total distortion factor	0.3 % (1 kHz 1 W)
Input sensitivity /Impedance	1500 mV/ 47kΩ (LINE)
SN ratio	60dB (LINE, IHF-A) 70dB (iPod/Bluetooth, IHF-A)

■ Speaker

Speaker output	Satellite 6 ch, Subwoofer 1 ch
Unit	6 cm cone (Satellite) 10 cm cone (Subwoofer)

■ Bluetooth

Version	2.1 + EDR
Profile	A2DP 1.2, AVRCP 1.0
Codec	SBC, AAC
Contents protection	SCMS-T

Specifications and features are subject to change without notice.

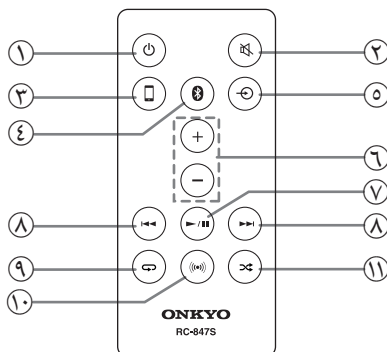

- | | |
|--------------------|---------------------------|
| ١ زر (التيار) | ٦ زر مستوى الصوت +/- |
| ٢ الزر (MUTING) | ٧ الزر II /▶ |
| ٣ الزر (iPod) | ٨ الزر ▶▶▶ /◀◀◀ |
| ٤ الزر (BLUETOOTH) | ٩ الزر (REPEAT) |
| ٥ الزر (الزر LINE) | ١٠ الزر ((3D)) (3D SOUND) |
| | ١١ الزر (SHUFFLE) |

المواصفات

المواصفات	عام
ستالايت ٦ قنوات. مجهار الترددات الخفيضة الفرعي ١ قناة ٦ سم مخروطي (ستالايت) ١٠ سم مخروطي (مجهار الترددات الخفيضة الفرعي)	أقصى مستوى من الحرج الفعلي ٥ وات ٦ قنوات. ٤ أوم (ستالايت) ١٠ وات ١ قناة. ٤ أوم (مجهار الترددات الخفيضة الفرعي) (THD+N) 1٪ أو أقل. ٦,١ مشغل قنوات (مشغل تزامني))
2.1 + EDR	مصدر القدرة والبولطية
AVRCP 1.0, A2DP 1.2	استهلاك القدرة
AAC, SBC	استهلاك القدرة بدون صوت
SCMS-T	القدرة في وضع الانتظار
	الأبعاد الخارجية القصوى
	الوزن
المواصفات والمزايا عرضة للتغيير دون إشعار.	دخول أنالوغ ٣,٤ كجم LINE (١ خطي)
	مضخم صوت
	معامل التشويه الإجمالي
	حساسية الدخل /المقاومة
	نسبة SN
	٠,٣ ٪ (١ كيلو هرتز ١ وات)
	١٥٠٠ مللي فولت/ ٤٧ كيلو أوم (LINE)
	٦٠ ديسيبل (IHF-A, LINE)
	٧٠ ديسيبل (IHF-A, iPod/Bluetooth)

اللوحة الأمامية واللوحة الخلفية

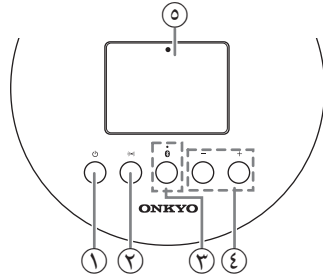
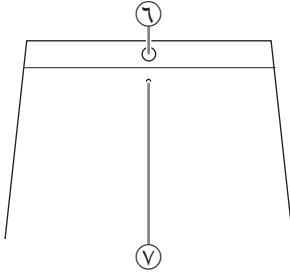

٥ قاعدة iPod/iPhone dock

٦ منطقة استقبال الضوء لوحدة التحكم عن بعد

٧ مؤشر التيار/التشغيل

١ الزر (التيار)

٢ الزر ((3D SOUND))

٣ الزر (BLUETOOTH)، مؤشر Bluetooth

٤ زر مستوى الصوت +/-

اللوحة الخلفية

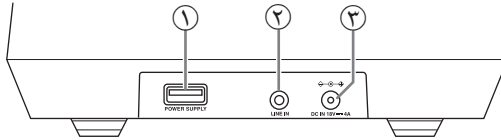

١ طرف توصيل POWER SUPPLY

٢ طرف توصيل LINE IN

٣ طرف توصيل DC IN

١. تسجيل مواد ذات حق الطبع والنشر- ما لم يكن للاستخدام الشخصي فقط، فإنه من غير الجائز قانوناً تسجيل مواد مشمولة بالحماية وفقاً لحق الطبع والنشر بدون إذن صاحب حق الطبع والنشر.

٢. **مصهر التيار المتردد**- يحظر على المستخدم صيانة مصهر التيار المتردد الموجود داخل الوحدة إذا تعذر عليك إيقاف تشغيل الوحدة، يرجى الاتصال بموزع Onkyo لنديك.

٣. **العنابية**- من حين لآخر يجب عليك أن تتفحص العنابر عن الوحدة بأكملها بقطعة قماش ناعمة. بالنسبة للبقع الصلبة استخدم قطعة قماش مبللة بمحلول ضعيف مكون من منظف غير قوي وماء. جفف الوحدة بعد ذلك على الفور قطعة قماش نظيفة. لا تستخدم قطع قماش حادة، أو مخففات طلاء، أو كحول أو غير ذلك من المذيبات الكيماوية حيث أنها قد تتسبب في إلحاق التلف بطبقة الطلاء الخارجية أو إزالة الحروف المكتوبة على اللوحة.

٤. الكهرباء

تنبيه

قبل توصيل قابس الوحدة بمصدر الكهرباء للمرة الأولى اقرأ القسم التالي بعناية.

يختلف جهد منفذ التيار المتردد من دولة لأخرى. ومن ثم، فلتأكد من أن الجهد الكهربائي في المنطقة التي تقيم بها يفي بالمتطلبات المطبوع على اللوحة الخلفية للوحدة (على سبيل المثال: تيار متردد ٢٣٠ فولت، ٥٠ هرتز، أو تيار متردد ١٢٠ فولت، ٦٠ هرتز).

يستخدم قابس سلك الكهرباء لفصل هذه الوحدة عن مصدر التيار المتردد. تأكد من سهولة تشغيل القابس (سهولة توصيله وفصله) في جميع الأوقات.

لا يترتب على ضغط زر [STANDBY/ON] لاختيار وضع الاستعداد إيقاف تشغيل الوحدة بالكامل. إذا كنت بصدد عدم استخدام الوحدة لفترة طويلة، انزع سلك الكهرباء من منفذ التيار المتردد.

٥. تفادي فقدان السمع

تنبيه

قد يتسبب ضغط الصوت الزائد الصادر من سماعات الأذن وسماعات الرأس في فقدان السمع.

٦. البطاريات والتعرض للحرارة

تحذير

يجب ألا يتم تعريض البطاريات (مجموعة البطارية أو البطاريات المركبة) للحرارة الزائدة مثل أشعة الشمس أو النار أو ما شابه ذلك.

٧. **يحظر لمس هذه الوحدة عندما تكون يداك مبتلتيين**- يحظر إمساك هذه الوحدة أو سلك الكهرباء المتصل بها عندما تكون يداك مبتلتيين أو رطبتين. إذا تسرب الماء أو أي سائل آخر داخل هذه الوحدة، اعدبها لوكيل Onkyo لفحصها.

٨. ملاحظات التداول

- إذا احتجت إلى نقل هذه الوحدة، استخدم العبوة الأصلية لتعبئتها داخلها بالوضع الذي كانت عليه عندما قمت بشرائها في البداية.
- لا تترك مواداً مطاطية أو بلاستيكية فوق هذه الوحدة لمدة طويلة، لأنها قد تخلف أثراً على الصندوق.
- قد تسخن اللوحات العلوية والخلفية لهذه الوحدة بعد الاستخدام لمدة طويلة. وهذا أمر عادي.
- إذا لم تستخدم هذه الوحدة لفترة طويلة، فقد لا تعمل كما ينبغي في المرة التالية لتشغيلها، لذا احرص على استعمالها على فترات متفاوته.

التخزين الاحتياطي في الذاكرة

يستخدم جهاز استقبال الصوت والصورة نظام التخزين الاحتياطي بالذاكرة بدون بطارية للاحتفاظ بالقيم المضبوطة مسبقاً لاستقبال اللاسلكي وغيرها من الإعدادات عندما لا يكون متصلاً بالكهرباء أو في حالة انقطاع الكهرباء. على الرغم من عدم الحاجة إلى بطاريات فإنه يجب توصيل جهاز استقبال الصوت والصورة بمنفذ التيار المتردد لشحن نظام التخزين الاحتياطي، وفور شحنه فإن جهاز استقبال الصوت والصورة يحتفظ بالإعدادات لمدة أسابيع، على الرغم من أن ذلك يتوقف على البيئة المحيطة ونقل الفترة في الأجواء الرطبة.

بالنسبة للطرزات المستخدمة في المملكة العربية السعودية

يجب أن يتم استبدال وتركيب قابس التيار المتردد بسلك الإمداد بالكهرباء في هذه الوحدة على أيدي أخصائيي صيانة مؤهلين.

هام

أسلاك التوصيل بالمأخذ الرئيسي ملونة وفقاً للشفرة التالية:

الأزرق: محايد

البنّي: مكهرب

وإذا لم تتفق ألوان أسلاك التوصيل بالمأخذ الرئيسي لهذا الجهاز مع العلامات اللونية المحددة لأطراف التوصيل في القابس، اتبع الخطوات التالية:

يجب توصيل السلك ذي اللون الأزرق بطرف التوصيل المميز بحرف N أو الأسود اللون.

يجب توصيل السلك ذي اللون البنّي بطرف التوصيل المميز بحرف L أو الأحمر اللون.

هام

القابس مجهز بمصهر مناسب. إذا تطلب الأمر تغيير المصهر، يجب أن يكون المصهر معتمد من الجمعية الأمريكية للمواصفات القياسية (ASTA) أو المعهد البريطاني للمواصفات القياسية (BSI) ومطابقاً للمواصفات القياسية البريطانية BS1362 ويجب أن يكون له نفس تقنين الأمبير المبين على القابس. ابحث عن علامة ASTA أو علامة BSI على جسم المصهر.

إذا لم يكن قابس سلك الكهرباء مناسباً لمنافذ الكهرباء الخاصة بالمقابس لديك، فقم بفصله واستبدله بقابس مناسب. ضع مصهراً مناسباً في القابس.

تنبيه:

لتقليل خطر التعرض لصدمة كهربائية أو حريق، يحظر تعريض هذا الجهاز للمطر أو الرطوبة.

تحذير:

لتقليل خطر التعرض لصدمة كهربائية، يحظر رفع الغطاء (أو الجزء الخلفي) لا توجد قطع قابلة للاستخدام بالداخل. يرجى استشارة أخصائيي صيانة مؤهلين للقيام بأعمال الصيانة.



ومضة البرق التي تنتهي برمز رأس السهم داخل مثلث متساوي الأضلاع مخصصة لتنبيه المستخدم إلى وجود "جهد خطر" غير مغزول داخل هيكل المنتج وهو يقدّر كإنتاج لتشكيل خطر تعريض الأشخاص لصدمة كهربائية.



علامة التعجب داخل مثلث متساوي الأضلاع مخصصة لتنبيه المستخدم إلى وجود تعليمات هامة للتشغيل والصيانة (الإصلاح والخدمة) في المطبوعات المصاحبة للجهاز.



تعليمات هامة بخصوص السلامة

١. اقرأ هذه التعليمات.
 ٢. احتفظ بهذه التعليمات.
 ٣. انتبه لجميع التحذيرات.
 ٤. اتبع جميع التعليمات.
 ٥. لا تستخدم هذا الجهاز بالقرب من الماء.
 ٦. لا يتم تنظيفه إلا بقطعة قماش جافة.
 ٧. حذار من انسداد أي فتحة من فتحات التهوية. التركيب وفقاً لتعليمات الشركة المصنعة.
 ٨. يحظر التركيب بالقرب من أية مصادر للحرارة من المشعات، أو مسجلات الحرارة، أو المواقد، أو غيرها من الأجهزة (بما في ذلك المكبرات) التي تشع حرارة.
 ٩. حذار من مخالفة أعراض السلامة بشأن القابض المستقطب أو القابض الأرضي. يحتوي القابض المستقطب على ريشتين إحداهما معرض من الأخرى. يحتوي القابض الأرضي على ريشتين وطرف ثالث للتأريض. والغرض من الريشة العريضة أو الطرف الثالث توفير الأمان. وإذا تعذر إدخال القابض في منفذ الكهرباء، استشر كهربائياً لاستبدال منفذ الكهرباء القديم.
 ١٠. وفر الحماية لسلك الكهرباء من سير الآخرين فوقه أو تعرضه للقطع خاصة عند القابض أو المقابض الملائمة أو نقطة خروجه من الجهاز.
 ١١. لا تستخدم سوى المرفقات والملحقات المحددة من جانب الشركة المصنعة.
 ١٢. لا تستخدم سوى العربية، أو الحامل، أو الحامل ثلاثي الأرجل، أو الطاولة المحددة من جانب الشركة المصنعة، أو التي يتم بيعها مع الجهاز. عند استخدام عربية، توخ الحرس عند تحريك العربية/الجهاز معاً لتجنب التعرض للإصابة من جراء انقلابهما.
 ١٣. انزع القابض الكهربائي من هذا الجهاز خلال التعرض لعواصف رعدية أو عدم الاستخدام لفترات زمنية طويلة.
 ١٤. اعهد بجميع عمليات الصيانة والإصلاح لأخصائيي صيانة مؤهلين. يجب إجراء صيانة عند تعرض الجهاز للتلوث بأية طريقة من الطرق، كأن يتعرض سلك الإمداد بالكهرباء أو القابض للتلوث، أو انسكاب سائل أو سقوط أشياء داخل الجهاز، أو عند تعرض الجهاز للمطر أو الرطوبة، أو عندما لا يعمل بطريقة عادية، أو عند سقوطه.
١٥. التلّف الواجب إصلاحه
- قم بنزع قابض الكهرباء الخاص بالجهاز من منفذ الكهرباء الموجد بالحاظ واعهد بالصيانة لأخصائيي صيانة مؤهلين في الحالات التالية:
- أ. عند تعرض سلك أو قابض الإمداد بالكهرباء للتلوث،
 - ب. إذا انسكب سائل، أو سقط شيء داخل الجهاز،
 - ج. إذا تعرض الجهاز للمطر أو الماء،
 - د. إذا لم يعمل الجهاز بطريقة عادية رغم التقيد بتعليمات التشغيل.
- قم بضبط مفاتيح التحكم التي تشملها تعليمات التشغيل فقط حيث أن الضبط غير الصحيح لمفاتيح التحكم الأخرى قد يؤدي إلى التلف وغالباً ما يتطلب ذلك مجهوداً كبيراً من جانب فني مؤهل لإعادة تشغيل الجهاز في وضع التشغيل العادي.
- هـ. إذا تعرض الجهاز للسقوط أو التلف بأية طريقة من الطرق، و
- و. عندما يعتبري الجهاز تغير واضح في الأداء فإنك تشير إلى ضرورة صيانته.
١٦. دخول الأشياء والسوائل
- يحظر إدخال أشياء من أي نوع عنوة داخل الجهاز عبر الفتحات حيث أنها قد تلامس نقاط ذات جهد خطر أو تتسبب في حدوث صدمة كهربائية في أجزائه مما قد يؤدي إلى نشوب حريق أو التعرض لصدمة كهربائية.
- لا يجب تعريض الجهاز لدخول كميات صغيرة أو كبيرة من السوائل بداخله ولا يجب وضع أشياء مملوءة بالسوائل كالمزهرات فوق الجهاز.
- لا تضع شموعاً أو أية أشياء مشتعلة فوق الوحدة.
١٧. البطاريات
- راعي على الدوام القضايا البيئية وتقيّد باللوائح المحلية عند التخلص من البطاريات.
١٨. إذا قمت بتركيب الجهاز في موقع تركيب داخلي، مثل خزانة الكتب أو رفوفها، احرص على التأكد من وجود تهوية كافية.
- اترك مسافة خالية قدرها ٢٠ سم (٨ بوصة) من أعلى وعلى الجانبين و١٠ سم (٤ بوصة) في الخلف. يجب أن تبعد الحافة الخلفية للرف أو اللوح الذي يعلو الجهاز مسافة ١٠ سم (٤ بوصة) عن اللوحة الخلفية أو الحائط، مما ينشئ فجوة شبيهة بالمدخنة لتسريب الهواء الدافئ.



819155A

ONKYO

Onkyo Corporation

2-1, Nisshin-cho, Neyagawa-shi, OSAKA 572-8540, JAPAN

Tel: 072-831-8023 Fax: 072-831-8163

<http://www.onkyo.com/>

Onkyo U.S.A. Corporation

18 Park Way, Upper Saddle River, N.J. 07458, U.S.A.

Tel: 800-229-1687, 201-785-2600 Fax: 201-785-2650

<http://www.us.onkyo.com/>

Onkyo Europe Electronics GmbH

Liegnitzerstrasse 6, 82194 Groebenzell, GERMANY

Tel: +49-8142-4401-0 Fax: +49-8142-4208-213

<http://www.eu.onkyo.com/>

Onkyo Europe Electronics GmbH (UK Branch)

The Coach House 81A High Street, Marlow, Buckinghamshire, SL7 1AB, UK

Tel: +44-(0)1628-473-350 Fax: +44-(0)1628-401-700

Onkyo China Limited

Unit 1033, 10/F, Star House, No 3, Salisbury Road, Tsim Sha Tsui Kowloon, Hong Kong.

Tel: 852-2429-3118 Fax: 852-2428-9039

<http://www.onkyochina.com/>

Onkyo China PRC

1301, 555 Tower, No.555 West NanJin Road, Jin an, Shanghai,

China 200041, Tel: 86-21-52131366 Fax: 86-21-52130396

<http://www.cn.onkyo.com/>

C1208-1

SN 29401366

(C) Copyright 2012 Onkyo Corporation Japan. All rights reserved.



* 2 9 4 0 1 3 6 6 *