

# Midea Cooker Hood Instructions

---

MODEL: MHT60BL  
MHT90BL



SAVE THESE INSTRUCTIONS CAREFULLY

Read the instructions carefully before using your cooker hood, and keep them carefully.  
If you follow the instructions, your cooker hood will serve you many years well.

# RECOMMENDATIONS AND SUGGESTIONS



The instructions apply to several versions of this appliance. Accordingly, you may find descriptions of individual features that do not apply to your appliance.

## INSTALLATION

- The manufacturer will not be held liable for any damages resulting from incorrect or improper installation.
- The minimum distance between the supporting surface for the cooking vessels on the hob and the lowest part of the cooker hood. (When the cooker hood is located above a gas appliance, the distance shall be at least 65 cm. If the installation instructions for the gas hob specify a greater distance, it has to be taken into account. The distance of 65 cm can be reduced for non-combustible parts of the cooker hood and parts operating at safety extra low voltage, provided these parts do not give access to live parts if deformed.)
- Check that the mains voltage corresponds to that indicated on the rating plate fixed to the inside of the hood.
- For Class I appliances, check that the domestic power supply guarantees adequate earthing.
- Connect the extractor to the exhaust flue through a pipe with the minimum diameter of 120 mm.
- The route of the flue must be as short as possible.
- The air must not be discharged into a flue that is used for exhausting fumes from appliances, burning gas or other fuels.
- If the extractor is used in conjunction with non-electrical appliances (e.g. gas burning appliances), a sufficient degree of aeration must be guaranteed in the room in order to prevent backflow of the exhaust gas. The kitchen must have an opening communicating directly with the open air in order to guarantee the entry of clean air.
- When the cooker hood is used in conjunction with appliances supplied with energy other than electric, the negative pressure in the room must not exceed 0.04 mbar to prevent fumes being drawn back into the room by the cooker hood.
- If the supply cord is damaged, it must be replaced by the manufacturer, its service agent or similarly qualified persons in order to avoid a hazard.
- Regulations concerning the discharge of air have to be fulfilled.

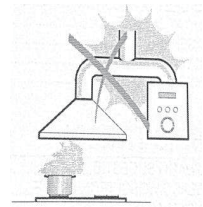

## USE

- The cooker hood is only for home use, not suitable for barbecue, roast shop and other commercial purposes.
- Never use the hood for purposes other than those intended.
- Never leave high naked flames under the hood when it is in operation.
- Adjust the flame intensity to direct the the flame upto the bottom of a pan only, making sure that it does not engulf the sides.
- Deep fat fryers must be continuously monitored during use: overheated oil can burst into flames.
- Do not flame under the cooker hood, with a risk of fire.
- This appliance can be used by children aged 8 and above and persons with reduced physical, sensory or mental capabilities or lacking experience and knowledge if they have been given supervision or instruction concerning use of the appliance in a safe way and understood the hazards involved.
- Children should be supervised to ensure that they do not play with the appliance.
- Cleaning and maintenance shall not be made by children without supervision.
- "CAUTION: Accessible parts may become hot when used with cooking appliances".

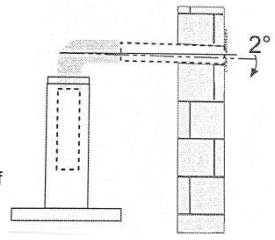

## MAINTENANCE

- The cooker hood and its filter should be cleaned regularly according to the instructions.
- Switch off or unplug the appliance from the mains supply before carrying out any maintenance work.
- Clean and/or replace the filters after the specified period (fire hazard).
- Clean the hood using a damp cloth and a neutral liquid detergent.
- The appliance uses 4 hob elements at most.

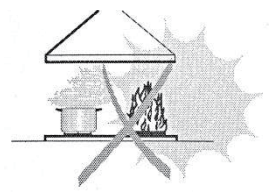

# COMPONENTS

Ref.	Qty.	Product Components
1	1	Hood Body, complete with Control, Light, Blower, Filter.
2.1	1	Lower Decorative Chimney
2.2	1	Upper Decorative Chimney
4	1	Exhaust Pipe
5	2	Activated Charcoal Filter (optional)

Qty.	Documentation
1	Instruction Manual

Ref.	Qty.	Standard Installation Components
10	5	Screw 5 x 50
11	5	Wall Plug
12	4	Screw 4,2 x 9,5
13	2	Screw 5 x 12
20	1	Hood Fixing Bracket
21	1	Chimney Fixing Bracket

If choose the below installation components, see as (solution 2)

Ref.	Qty.	Installation Components
10	7	Screw 5x50
11	7	Wall Plug
12	6	Screw 4,2x9,5
20	1	Hood Fixing Bracket
21	2	Chimney Fixing Bracket

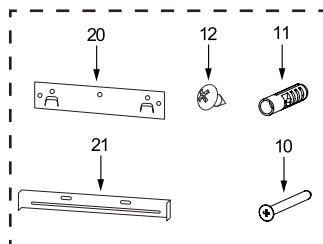
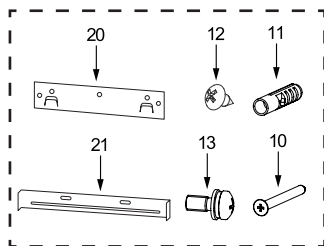
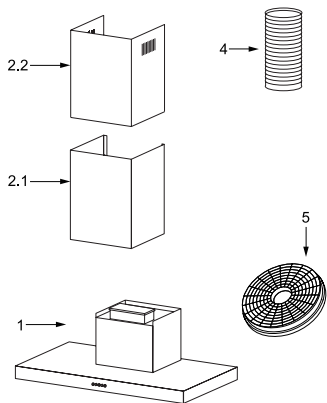

# DIMENSION

In mm

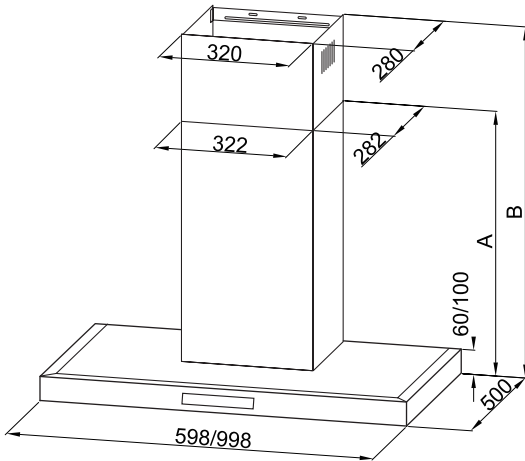
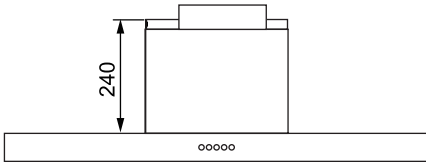
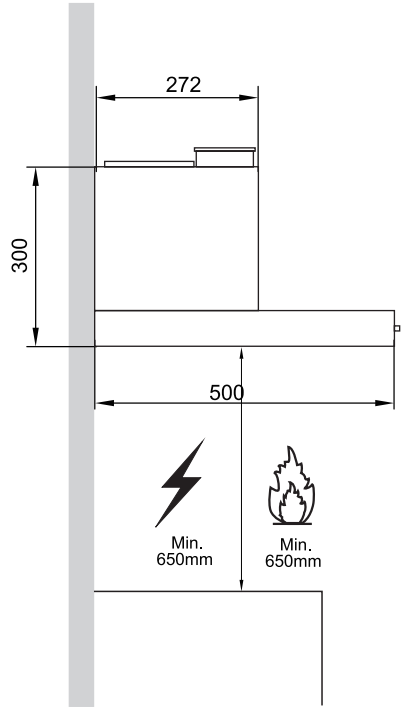
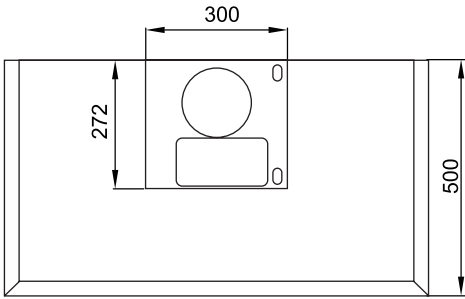

	Chimney	A	B
1	400+400	448	485-838

# INSTALLATION

## WALL DRILLING AND BRACKET FIXING

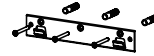
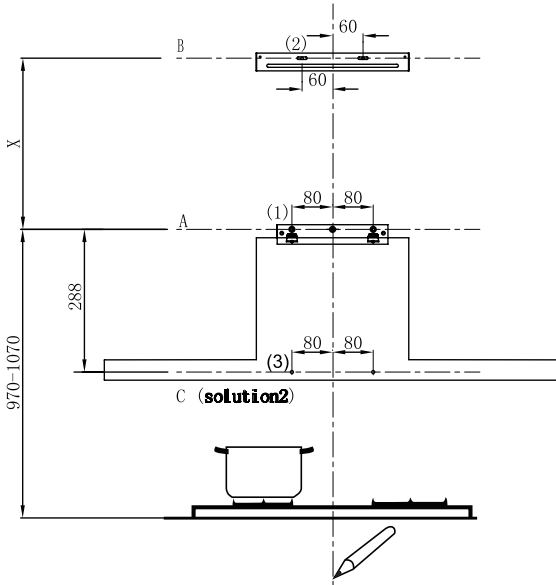

Option	Chimney	X
1	400X400	155-500

### As the first step, proceed with the following drawings:

- A vertical line up to the ceiling or up to the upper limit, at the center of the area in which the hood is to be fitted.
- A horizontal line **A** at **970 – 1070** mm above the cooker top.
- A horizontal line **B** at **X** mm above the horizontal line **A**.
- A horizontal line **C** at **288** mm below the horizontal line **A**.

### Mark points:

- Mark a point **(1)** on the horizontal line **A**, **80** mm to the vertical reference line.
- Repeat this operation on the other side and on the vertical reference line, checking that the three marks are on one horizontal line.
- Mark a point **(2)** on the horizontal line **B**, **60** mm to the right of the vertical reference line.
- Repeat this operation on the other side, checking that the two marks are on one horizontal line.
- Mark a point **(3)** on the horizontal line **C**, **80** mm to the right of the vertical reference line **(solution2)**.
- Repeat this operation on the other side, checking that the two marks are on one horizontal line.

### Fix the brackets:

- Drill at the marked points **(1)**, **(2)**, **(3) (solution 2)**, using a  $\phi 10$  mm drill bit.
- Insert the wall plugs **11** into the holes **(1)**, **(2)**, **(3) (solution 2)**.
- Fix the hood fixing bracket **20** with 3 screws **10** (5 x 50) at the horizontal line A,
- Fix the chimney fixing bracket **21** with 2 screws **10** (5 x 50) at the horizontal line C.

## Hook the hood body

- Hook the hood body to the bracket 20.
- Level the hood body itself.
- Lock screws (M5\*12) into the hood fixing bracket to prevent the hood body from accidentally sliding off. Remove the filter from the inside of the hood body, and fix the screw 10 to wall plug 11 at the point (3) (optional).

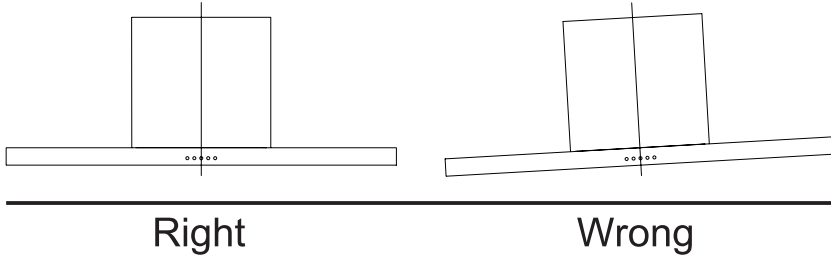

## CONNECTIONS

### DUCTED VERSION AIR EXHAUST SYSTEM

When installing the ducted version, connect the hood to the chimney using either a flexible or a rigid pipe of  $\phi$  150 or  $\phi$  120 mm, the choice of which is left to the installer.

- Insert the reducer flange 3 onto the hood body outlet to install a  $\phi$  120 mm air exhaust connection.
- Fix the pipe 4 in place using sufficient pipe clamps (not supplied).
- Remove possible charcoal filters.

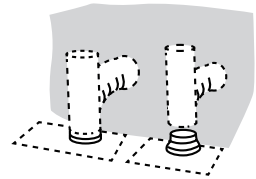

## CHIMNEY ASSEMBLY

The chimney can only be installed with an exhausting hood.

### Lower decorative chimney

- Fix the chimney fixing bracket 21 onto the lower decorative chimney with 2 screws 12 (4.2 x 9.5) supplied with the hood.

### Upper decorative chimney

- Insert the upper decorative chimney 2.2 into the lower decorative chimney 2.1 and drag it up to the bracket 21.
- Fix the upper chimney onto the bracket 21 with 2 screws 12 (4.2 x 9.5) supplied with the hood.

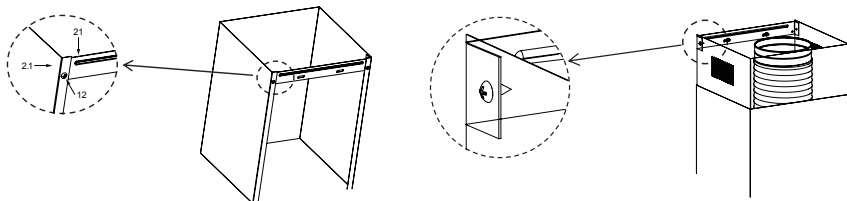

# USE

---

## Speed

### Adjustment

After the hood is switched on, a beep sound will be heard and all key lights be lit up for 1 s, indicating the hood has been powered on:

- **Power Key:** Control the motor power. Under standby state, press the “power” button, “power” key light is on, the motor starts up at low speed, and digital screen displays setting 1; Under power-on state, press the “power” button, enter 3-min-delay-shutdown state, setting is switched to low speed, and the power key flashes every second, which means entering delay-shutdown state; Under delay-shutdown state, press the “power” button, it shuts down immediately (motor stops running).
- **Light Key:** Independently control the light on and off free from the effect of other keys. Press it once, the light is on, meanwhile the light key light is on; Press again, the light is off and the light key light is off too.
- **Plus (+) Key:** Valid under power-on state, press plus (+) key once, motor speed increases one setting, and digital tube displays corresponding setting. When the plus (+) key is pressed, plus (+) key light is on. When at the highest setting, only give out key touch sound, the setting no longer changes.
- **Minus (-) Key:** Valid under power-on state, press “minus (-)” key once, motor speed decreases one setting, and digital tube displays corresponding setting. When the “minus (-)” key is pressed, “minus (-)” key light is on. When at the lowest setting, only give out key touch sound, the setting no longer changes.



Light



Minus



Digital Screen



Plus



Power

# MAINTENANC

---

## GREASE FILTER

---

### METAL SELF-SUPPORTING GREASE FILTER CLEANING

- The filters must be cleaned every 2 months of operation or more frequently for particularly heavy usage, and can be washed in a dishwasher.
- Remove the filters one by one by pushing them towards the back side of the hood unit and simultaneously pulling downwards.
- Any kind of bending of the filters has to be avoided when washing them. Before fitting them again into the hood, make sure that they are completely dry. (The color of the filter surface may change over time, but this has no influence to the filter efficiency).
- When fitting the filters into the hood, pay attention that they should be mounted in correct position with the handle facing outwards.

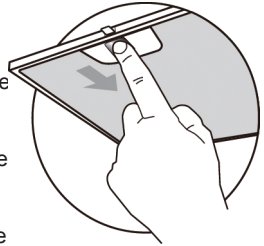

## ACTIVATED CHARCOAL FILTER (RECIRCULATION VERSION)

---

These filters are not washable and cannot be regenerated, and must be replaced approximately every 4 months of operation or more frequently for heavy usage.

## ACTIVATED CHARCOAL FILTER REPLACEMENT

---

- Remove the metal grease filters.
- Remove the saturated activated charcoal filter.
- Fit the new filters.
- Replace the metal grease filters.

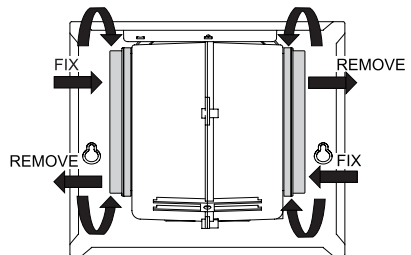

# LIGHTING

---

## LIGHT REPLACEMENT

### Replacing the light module

- You should not replace the light bulb but the entire light module.
- When changing the light module, the contacts are live.
- Before changing the light module, unplug the appliance from the mains or switch off the circuit breaker in the fuse box.

### Dismantling LED light module

- Remove the grease filter, and carefully remove 2 screws from the front plate (a cross headed screwdriver will be needed to remove the screws).
- Disconnect the terminal of LED light.
- Press LED light at the back of the front plate, and take the LED light out.
- Replace the light (commercially available LED light (max. 1.5 w).

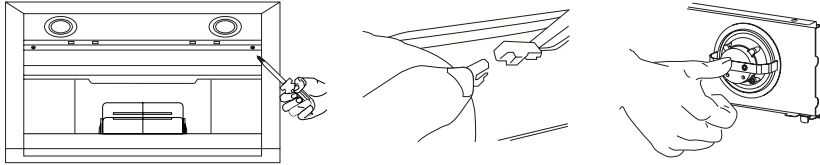

	Max Power	Voltage	Picture	Light Cap	ILCOS D Code
Round/ Diameter: 70 mm	1.5 W	DC 12 V		— —	DSR-1.5-S-70

### Reinstalling LED light module

- Press LED light in the front of front plate, and install the LED light onto the front plate.
- Connect the terminal of LED light and light leads.
- Carefully fasten 2 screws on the front plate, and reinstall the grease filter.

## OLD ELECTRICAL APPLIANCE DISPOSAL



The European Directive 2012/19/EU on Waste Electrical and Electronic Equipment (WEEE), requires that old household electrical appliances must not be disposed of in the normal unsorted municipal waste stream. Old appliances must be collected separately in order to optimize the recovery and recycling of the materials they contain and reduce the impact on human health and the environment.

The crossed out “Wheeled Bin” symbol on the product reminds you of your obligation, that when disposing the appliance, you need separately collect them.

Consumers should contact their local authority or retailer for information concerning the correct disposal of their old appliance.

# TROUBLE SHOOTING

Fault	Cause	Solution
Light is on, but motor does not work	The blade is blocked.	
	The capacitor is damaged.	Replace the capacitor.
	The motor is damaged.	Replace the motor.
	The internal wiring of motor is cut off/ disconnected. An unpleasant smell may be produced.	Replace the motor.
Both light and motor do not work	Apart from the above mentioned, check the following:	
	Light is damaged.	Replace the light.
	Power cord is loose.	Connect the cord as per the electric diagram.
Oil leakage	Outlet and the air ventilation entrance are not tightly sealed.	Take down the outlet and seal with glue.
	Leakage from the connection of U-shaped section and cover.	Take down U-shaped section and seal with soap or paint.
Vibration	The blade, if damaged, can cause vibration.	Replace the blade.
	The motor is not tightly fastened.	Fasten the motor tightly.
	The cooker hood is not tightly fixed.	Fix the cooker hood tightly.
Insufficient suction	The distance between the cooker hood and the cooker top is too large.	Readjust the distance.
	Too much ventilation from open doors or windows.	Choose a new place to install the appliance or close some doors / windows.
Machine incline	The fixing screw is not tight enough.	Tighten the fixing screw and make it horizontal.
	The hanging screw is not tight enough	Tighten the hanging screw and make it horizontal.



**Maintenance schedule:**

To ensure the appliance continues to operate at peak performance, we recommend a routine service call every 3 years for the life of the appliance.

FOR SPARE PARTS OR TO FIND THE ADDRESS OF  
YOUR NEAREST STATE SPARE PARTS CENTRE IN AUSTRALIA

MIDEA HOME APPLIANCES AUSTRALIA PTY LTD

11/75 Lorimer Street, Docklands, Melbourne, 3008

After-sales service No.: 1800 88 60 10