

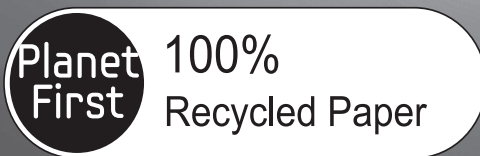

WA52J8060A*
WA52J8700A*

Washing Machine

user manual



This manual is made with 100% recycled paper.

Imagine the possibilities

Thank you for purchasing this Samsung product.



contents

INSTALLING YOUR WASHER	10	10 Unpacking your washer
		10 Overview of your washer
		11 Basic location requirements
		11 Electrical
		11 Grounding
		11 Water
		12 Drain facility
		12 Flooring
		12 Location considerations
		12 Alcove or closet installation
		13 Required dimensions for Installation
		13 Important note to installer
		17 Loading your washer
		17 Getting started
OPERATING INSTRUCTIONS	17	
WASHING A LOAD OF LAUNDRY	18	18 Overview of the control panel
		20 Child Lock [🔒]
		21 Sound
		21 Garment Plus 🧥
		21 My Cycle
		21 Delay End
		22 Pre Soak
		22 AquaJet™
		22 Eco Plus
		22 Mist Shower
		22 Smart Care
		23 Washing clothes using the cycle selector
		23 ATC (Auto Temperature Control)
		24 Prewash : Water Jet & Built-in sink (WA52J8700A*)
		25 Detergent use
		25 Features
		28 Cleaning the exterior
		28 Cleaning the interior
		28 Storing your washer
		28 Preserving the top cover and the front frame
		29 Cleaning the dispensers
		30 Self Clean
		31 Check these solutions if your washer...
		33 Information codes
MAINTAINING YOUR WASHER	28	
TROUBLESHOOTING	31	
APPENDIX	35	35 Fabric care chart
		36 Cycle chart
		38 Helping the environment
		38 Declaration of conformity
		38 Specification

safety information











Congratulations on your new Samsung Washer. This manual contains important information on the installation, use, and care of your appliance. Please take time to read this manual to take full advantage of your washer's many benefits and features.

WHAT YOU NEED TO KNOW ABOUT SAFETY INSTRUCTIONS

Warnings and Important Safety Instructions in this manual do not cover all possible conditions and situations that may occur. It is your responsibility to use common sense, caution, and care when installing, maintaining, and operating your washer.

IMPORTANT SAFETY SYMBOLS AND PRECAUTIONS

What the icons and signs in this user manual mean:

 WARNING	Hazards or unsafe practices that may result in severe personal injury or death . To reduce the risk of fire, explosion, electric shock, or personal injury when using your washer, follow these basic safety precautions:
 CAUTION	Hazards or unsafe practices that may result in minor personal injury or property damage .
	Do NOT attempt.
	Do NOT disassemble.
	Do NOT touch.
	Follow directions explicitly.
	Unplug the power plug from the wall socket.
	Make sure the machine is grounded to prevent electric shock.
	Call the service center for help.
	Note

These warning icons are here to prevent injury to you and others.

Please heed them explicitly.

After reading this section, keep it in a safe place for future reference.

 Read all instructions before using the appliance.

SAVE THESE INSTRUCTIONS

English - 3

safety information



WARNING: To reduce the risk of fire, electric shock, or injury to persons when using your appliance, follow basic precautions, including the following:

1. Read all instructions before using the appliance.
2. Do not wash or dry articles that have been previously cleaned in, washed in, soaked in, or spotted with gasoline, dry-cleaning solvents, other flammable or explosive substances as they give off vapors that could ignite or explode.
3. Do not allow children to play on or in the appliance. Close supervision of children is necessary when the appliance is used near children.
4. Before the appliance is removed from service or discarded, remove the lid of the washing or drying compartment.
5. Do not reach into the appliance if the drum is moving.
6. Do not install or store this appliance where it will be exposed to the weather.
7. Do not tamper with the controls.
8. Do not repair or replace any part of the appliance or attempt any servicing unless it is specifically recommended in the user-maintenance instructions or in published user-repair instructions that you understand and have the skills to carry out.
9. Do not add gasoline, dry-cleaning solvents, or other flammable or explosive substances to the wash water. These substances give off vapors that could ignite or explode.
10. Under certain conditions, hydrogen gas may be produced in a hot water system that has not been used for 2 weeks or more. **HYDROGEN GAS IS EXPLOSIVE.** If the hot water system has not been used for 2 weeks or more, before using a washer or combination washer-dryer, turn on all hot water faucets and let the water flow from each for several minutes. This will release any accumulated hydrogen gas. As the gas is flammable, do not smoke or use an open flame during this time.



State of California Proposition 65 Warnings:

WARNING: This product contains chemicals known to the State of California to cause cancer and reproductive toxicity.

SAVE THESE INSTRUCTIONS

English - 4



CRITICAL INSTALLATION WARNINGS

 Plug the power cord into an AC 120 V / 60 Hz/wall socket rated at 15 amps or higher. Use the socket for this appliance only. In addition, do not use an extension cord.

- Sharing a wall socket with other appliances, using a power strip, or extending the power cord may result in electric shock or fire.
- Do not use an electric transformer. It may result in electric shock or fire.
- Ensure that the power voltage, frequency, and current match the product's specifications. Failing to do so may result in electric shock or fire.

Have this appliance installed by a qualified technician or service company.

- Failing to do so may result in electric shock, fire, an explosion, problems with the product, or injury.

Remove all foreign substances such as dust or water from the power plug terminals and contact points using a dry cloth on a regular basis.

- Unplug the power plug and clean it with a dry cloth.
- Failing to do so may result in electric shock or fire.

Plug the power plug into the wall socket in the right direction so that the cord runs towards the floor.

- If you plug the power plug into the socket in the opposite direction, the electric wires within the cable may be damaged and this may result in electric shock or fire.



This appliance must be properly grounded.

Do not ground the appliance to a gas pipe, plastic water pipe, or telephone line.

- Improper grounding may result in electric shock, fire, an explosion, or problems with the product.
- Never plug the power cord into a socket that is not grounded correctly. Make sure the socket you use is grounded in accordance with local and national codes.



Do not install this appliance near a heater or flammable material.

Do not install this appliance in a humid, oily, or dusty location, or in a location exposed to direct sunlight or water (rain drops).

Do not install this appliance in a location where gas may leak.

- This may result in electric shock or fire.

Plug the power plug into the wall socket firmly. Do not use a damaged power plug, damaged power cord, or loose wall socket.

- This may result in electric shock or fire.

Do not pull or excessively bend the power cord.

Do not twist or tie the power cord.

Do not hook the power cord over a metal object, place a heavy object on the power cord, insert the power cord between objects, or push the power cord into the space behind the appliance.

- This may result in electric shock or fire.

Do not pull the power cord when unplugging the power plug.

- Unplug the power plug by holding the plug.
- Failing to do so may result in electric shock or fire.



If the power plug or power cord are damaged, contact your nearest service center.

SAVE THESE INSTRUCTIONS

safety information



INSTALLATION CAUTIONS



Position the appliance so that the power plug is easily accessible.

- Failing to do so may result in electric shock or fire due to electric leakage.

Install your appliance on a level and hard floor that can support its weight.

- Failing to do so may result in abnormal vibrations, noise, or problems with the product.



Unplug the power plug when the appliance is not being used for long periods of time or during a thunder/lightning storm.

- Failing to do so may result in electric shock or fire.



CRITICAL USAGE WARNINGS



If the appliance is flooded, cut the power immediately and contact your nearest service center.

If the appliance emits a strange noise, a burning smell, or smoke, unplug the power plug immediately and contact your nearest service center.

- Failing to do so may result in electric shock or fire.

In the event of a gas leak (such as propane gas, LP gas, etc.), ventilate the area immediately. Do not turn any appliance or light on or off.

- Do not use a ventilating fan.
- A spark may result in an explosion or fire.

Do not wash items contaminated with gasoline, kerosene, benzene, paint thinner, alcohol or other flammable or explosive substances.

- This may result in electric shock, fire, or an explosion.

Do not force the washer lid open while the washer is operating (high-temperature washing/drying/spinning).

- Water flowing out of the washer may cause burns or cause the floor to be slippery. This may result in injury.

- Forcing the lid open can damage the product or cause injury.

Make sure to remove the packaging (sponge, styrofoam) attached to the bottom of the washer before using it.

Do not insert your hand under the washer.

- This may result in injury.

SAVE THESE INSTRUCTIONS

English - 6

- 
- Do not touch the power plug with wet hands.
- This may result in electric shock.

Do not turn the appliance off by unplugging the power plug while the washer is in operation.

- Plugging the power plug into the wall socket again may cause a spark and result in electric shock or fire.

Keep all packaging materials well out of the reach of children, as packaging materials can be dangerous to children.

- If a child places a bag over their head, the child may suffocate.

Do not let children or infirm persons use this washer unsupervised.

- Failing to do so may result in electric shock, burns or injury.

Do not insert your hand or a metal object under the washer while it is operating.

- This may result in injury.

-
- 
- Do not attempt to repair, disassemble, or modify the appliance yourself.
- Do not use any fuse (such as copper, steel wire, etc.) other than the standard fuse.
 - If you need to repair or reinstall the appliance, contact your nearest service center.
 - Failing to do so may result in electric shock, fire, problems with the product, or injury.

-
- 
- If any foreign substance such as water enters the appliance in any area other than the tub, unplug the power plug and contact your nearest service center.
- Failing to do so may result in electric shock or fire.

If the water supply hose comes loose from the faucet and floods the appliance, unplug the power plug.

- Failing to do so may result in electric shock or fire.



USAGE CAUTIONS

- 
- If the washer is contaminated by a foreign substance such as detergent, dirt, food waste, etc., unplug the power plug and clean the washer using a damp, soft cloth.

- Failing to do so may result in discoloration, deformation, damage or rust.

The clear portion of the lid can be broken by a strong impact. Take care when using the washer.

- If the clear portion is cracked or broken, it may result in injury.

After a water supply failure or when reconnecting the water supply hose, open the faucet slowly.

Open the faucet slowly after a long period of non-use.

- The air pressure in the water supply hose or the water pipe may result in damage to a part or in water leakage.

If a drain error occurs during an operation, check if there is a draining problem.

- If the washer is used when it is flooded because of a draining problem, it may result in electric shock or fire due to electric leakage.

Do not insert your hand under the washer.

- This may result in injury.

SAVE THESE INSTRUCTIONS

English - 7

safety information

Insert the laundry into the washer completely so that laundry does not get caught in the lid.

- If laundry gets caught in the lid, it may result in damage to the laundry or the washer, or result in water leakage.

Ensure that the faucet is turned off when the washer is not being used.

- Ensure that the water supply hose connectors are properly tightened.
- Failing to do so may result in property damage or injury.

Open the faucet and check if the water supply hose connector is firmly tightened and that there is no water leaking before using the product.

- If the water supply hose connectors are loose, it may result in water leakage.

 Do not stand on top of the appliance or place objects (such as laundry, lighted candles, lighted cigarettes, dishes, chemicals, metal objects, etc.) on the appliance.

- This may result in electric shock, fire, problems with the product, or injury.

Do not operate the appliance with wet hands.

- This may result in electric shock.

Do not spray volatile material such as insecticide onto the surface of the appliance.

- As well as being harmful to humans, it may also result in electric shock, fire, or problems with the product.

Do not place an object that generates a electromagnetic field near the washer.

- This may result in injury due to a malfunction.

Since the water drained during a high-temperature wash or drying cycle is hot, do not touch the water.

- This may result in burns or injury.

For waterproof fabrics, only use the WATERPROOF cycle.

- Do not use other cycles for waterproof fabrics.
- * This may result in injury or damage to the washer, walls, floor, or clothing due to abnormal vibrations.
- Set the temperature and spin according to the attached care label.

Do not operate the washer when the detergent dispenser is removed.

- This may result in electric shock or injury due to water leakage.

Do not insert your hand into the detergent dispenser after opening it.

- This may result in injury as your hand may be caught.

SAVE THESE INSTRUCTIONS

English - 8

Do not place any non-laundry objects, such as shoes, food waste, or animals into the washer.

- This can cause abnormal vibrations that can damage the washer, and, in the case of pets, cause severe injury or death.

Do not press the buttons using sharp objects such as pins, knives, fingernails, etc.

- This may result in electric shock or injury.

Do not wash laundry contaminated by oils, creams, or lotions usually found in skincare shops or massage clinics.

- This may result in the rubber seal becoming deformed and water leakage.

Do not leave metal objects (safety pins, hair pins, etc.) or bleach in the tub for long periods of time.

- This may cause the tub to rust.
- If rust appears on the surface of the tub, apply a neutral cleansing agent to the surface and use a sponge to clean it. Never use a metal brush.

Do not use dry cleaning detergent directly in the tub and do not wash, rinse, or spin laundry contaminated by dry cleaning detergent.

- This may result in spontaneous combustion or ignition due to heat from the oxidation of the oil.

Do not use hot water from water cooling/heating devices.

- This may result in problems with the washer.

Do not use natural hand-washing soap in the washer.

- If it hardens and accumulates inside the washer, it may cause problems with the product, discoloration, rust, or bad odors.

Do not wash large laundry items such as bedding in the washing net.

- Failing to do so may result in injury due to abnormal vibrations.
- Place smaller items, such as lace socks and lingerie in the washing net.

Do not use hardened detergent.

- If it accumulates inside the washer, it may result in water leakage.

Do not wash throw rugs or doormats.

- If you wash throw rugs or doormats, the sand will accumulate inside the washer. It may result in error such as no draining.



WARNING

CRITICAL CLEANING INSTRUCTIONS



Do not clean the appliance by spraying water directly onto it.

Do not use the strong acid cleaning agent.

Do not use benzene, paint thinner, or alcohol to clean the appliance.

- This may result in discoloration, deformation, damage, electric shock, or fire.

Before cleaning or performing maintenance, unplug the appliance from the wall socket.

- Failing to do so may result in electric shock or fire.

SAVE THESE INSTRUCTIONS

English - 9

installing your washer

UNPACKING YOUR WASHER

Unpack your washer and inspect it for shipping damage. Make sure you have received all the items shown below. If your washer was damaged during shipping, or you do not have all of the items, contact 1-800-SAMSUNG (1-800-726-7864).

To prevent personal injury or strain, wear protective gloves whenever lifting or carrying the unit.

WARNING  Packing materials can be dangerous to children; Keep all packing material (plastic bags, polystyrene, etc.) well out of children's reach.

CAUTION  When unpacking the washing machine, 2 person collaboration is needed. To remove the cushion bottom of the packing materials, forward dumping is strictly prohibited.

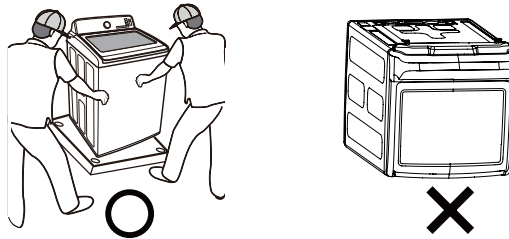

OVERVIEW OF YOUR WASHER

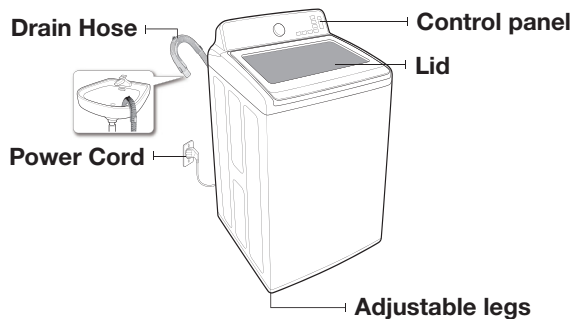

Parts supplied



Hose guide



User manual book



Plastic zip hose tie

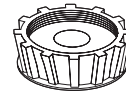

Water intake cap

Tools needed



Wrench



Flat screwdriver

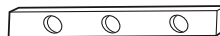

Level

Parts not supplied

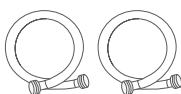

Water supply hoses



- If you lose an accessory and want to purchase a replacement, contact the Samsung service center (1-800-SAMSUNG (1-800-726-7864)).
- The design of the parts and accessories may differ from the pictures above. Their design is subject to change without notice for product improvement.
- Do not reuse old hoses. Only use new water supply hoses when you install the washing machine. Old water supply hoses can leak or burst causing flooding and property damage.
- Confirm that there are rubber washers inside each coupling of the water supply hoses.

BASIC LOCATION REQUIREMENTS

Electrical

- 120 Volt 60 Hz 15 AMP fuse or circuit breaker.
- Individual branch circuit serving only your Washer is recommended.
- Your Washer is equipped with a power cord.

 **CAUTION** NEVER USE AN EXTENSION CORD.

Grounding

ELECTRICAL GROUNDING IS REQUIRED FOR THIS APPLIANCE.

This appliance must be grounded. In the event of malfunction or breakdown, grounding will reduce the risk of electric shock by providing a path of least resistance for electric current.

This appliance is equipped with a power cord having a three-prong grounding plug for use in a properly installed and grounded outlet.

The plug must be plugged into an appropriate outlet that is properly installed and grounded in accordance with all local codes and ordinances.

 **WARNING** An improperly connected equipment-grounding conductor can increase the risk of electrical shock. Check with a qualified electrician or serviceman if you are not sure whether the appliance is properly grounded. Do not modify the plug provided with the appliance – if it does not fit the outlet, have a proper outlet installed by a qualified electrician.

IMPORTANT SAFETY PRECAUTIONS

- To prevent unnecessary risk of fire, electrical shock or personal injury, all wiring and grounding must be done in accordance with the National Electrical Code ANSI/FNPA, No. 70 Latest Revision and local codes and ordinances. It is the personal responsibility of the appliance owner to provide adequate electrical service for this appliance.

 **CAUTION** NEVER CONNECT THE GROUND WIRE TO PLASTIC PLUMBING LINES, GAS LINES, OR HOT WATER PIPES.

Water

To correctly fill your Washer in the proper amount of time, water pressure of 20 to 116psi (137 to 800kPa) is required.

Water pressure less than 20 psi may cause water valve failure, or may not allow the water valve to shut off completely, or may extend the fill time beyond what your Washer controls allow, causing your Washer to turn off. A time limit is built into the controls to prevent flooding in your home if a hose becomes loose.

The water faucets must be within 4 feet / 122 cm to the back of your Washer to match the inlet hoses provided with your Washer.

 Accessory inlet hoses are available in various lengths up to 10 feet / 275 cm for faucets that are further away from the back of your Washer.

To avoid the possibility of water damage:

- Have water faucets easily accessible.
- Turn off faucets when the washer is not in use.
- Periodically check that there is no leakage from the water inlet hose fittings.

 **WARNING** CHECK ALL CONNECTIONS AT THE WATER VALVE AND FAUCET FOR LEAKS.

installing your washer

Drain facility

The recommended height of the standpipe is 39 in / 99 cm. The drain hose must be routed through the drain hose clip to the standpipe. The standpipe must be large enough to accept the outside diameter of the drain hose. The drain hose is attached to the washer at the factory.

Flooring

For best performance, you must install your washer on a solidly constructed floor. Wood floors may need to be reinforced to minimize vibration and/or unbalanced load situations. Carpeting and soft tile surfaces are contributing factors to vibration which can cause your washer to move slightly during the spin cycle.

Never install your washer on a platform or weakly supported structure.

Location considerations

Do not install your washer in areas where water may freeze, since your washer will always retain some water in its water valve, pump, and hose areas. Frozen water can damage the belts, the pump, hoses, and other components.

Alcove or closet installation

MINIMUM CLEARANCES FOR CLOSET AND ALCOVE INSTALLATIONS:

Sides – 1 in / 25 mm

Closet Front – 2 in / 51 mm

Rear – 6 in / 152 mm

TOP - 21 in / 533 mm

Gap between end of water valve and the wall

- Case 1. Assemble supply hose after installing : Over 3.9 in (10 cm).

- Case 2. Assemble supply hose before installing : Over 2.8 in (7cm).

If the washer and dryer are installed together, the closet front must have at least a 72 in² (465 cm²) unobstructed air opening. Your washer alone does not require a specific air opening.

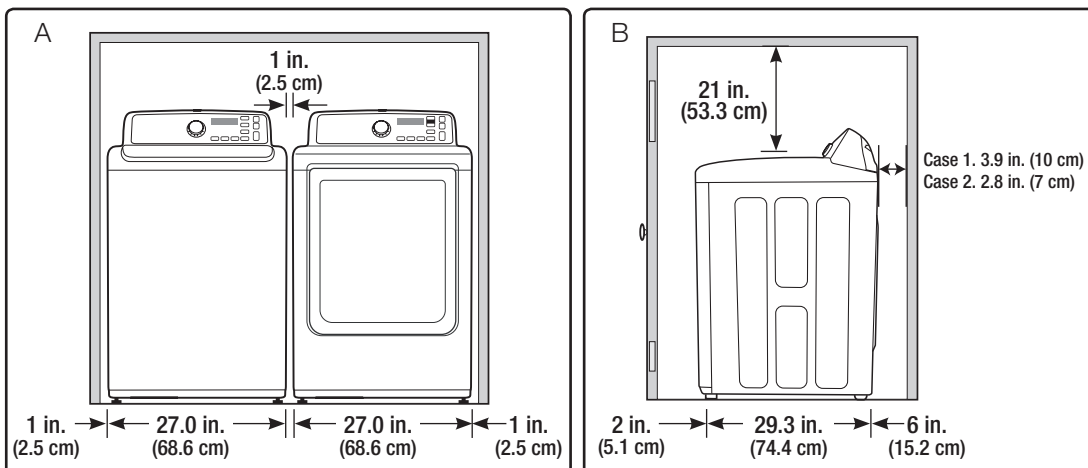

A. Recessed area

B. Side view - closet or confined area

Required dimensions for Installation

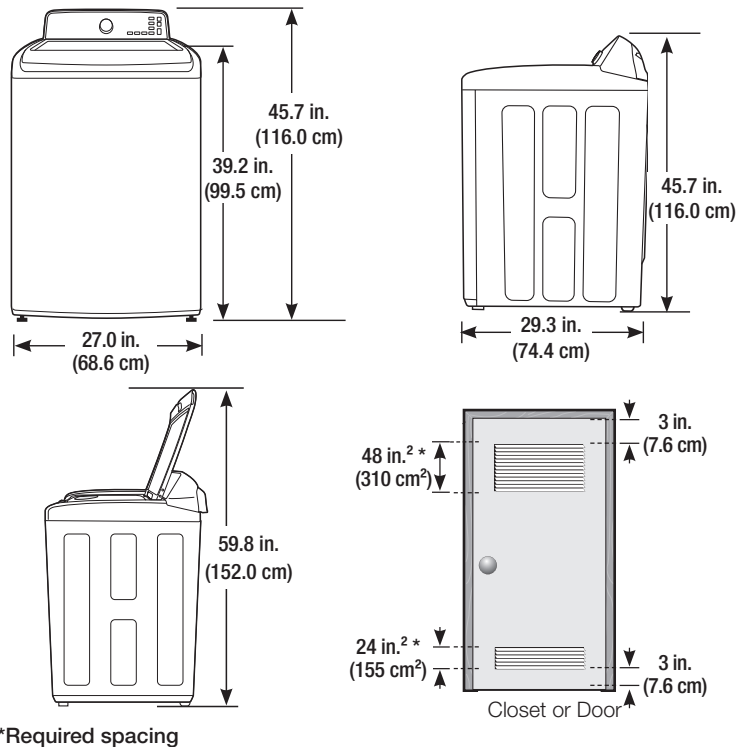

IMPORTANT NOTE TO INSTALLER

Please read the following instructions carefully before installing your washer.

These instructions should be retained for future reference.

We recommend you hire a professional to install this washer.

Installation Flow chart

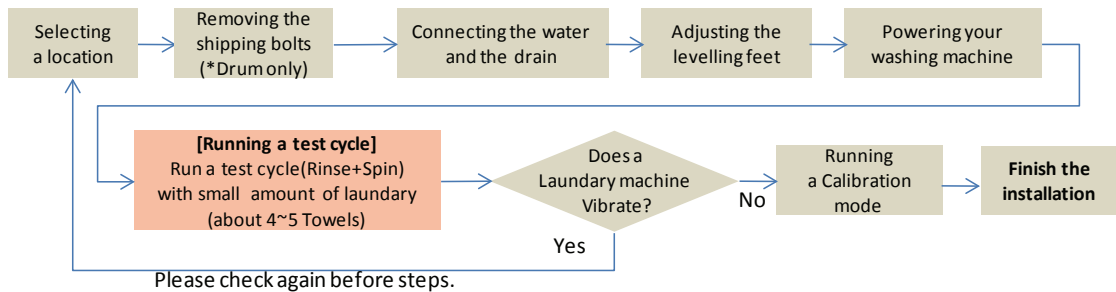

STEP 1 Selecting a Location

Before you install the washer, make sure the location:

- Has a hard, level surface without carpeting or flooring that may obstruct ventilation.
- Is away from direct sunlight.
- Has adequate ventilation.
- Is not exposed to freezing temperatures (temperatures under 32 °F or 0 °C).
- Is away from heat sources such as oil or gas.
- Has enough space so that the washer doesn't rest on its power cord.

installing your washer

STEP 2

Connecting the water and the drain

Connecting the water supply hose

CAUTION Before installing the water supply hoses, make sure there are rubber gaskets inside the fittings at both ends of each new water hose. Installing the water supply hoses without rubber gaskets can cause water leakage.

CAUTION When you initially install the washer, be sure to use new hoses. Failing to do so may result in a water leakage or overflow and may damage your property.

CAUTION Do not connect multiple water supply hoses together to increase the length of the supply hose. Hoses connected this way can leak and the leakage can cause electrical shock. If a hose is too short, replace the hose with a longer, high pressure hose.

1. Connect the ends of the water supply hoses to the HOT and COLD faucets.
2. Tighten the fittings by hand until they are snug, and then tighten them an additional two-thirds of a turn with a wrench.

CAUTION When you fasten the fittings, do not fasten them too tightly or apply tape or sealant to the faucets or water supply intakes. This can damage the fittings.

 After you have connected the water supply hoses to the faucets, ensure that they are connected correctly by pulling the water supply hoses downwards

3. Place the unconnected ends of the hoses into a bucket and open the faucets connected to the two water supply hoses for 10 or 15 seconds to remove any foreign substances from the hoses. Close the faucets before continuing.

4. Connect the ends of the water supply hoses to the water supply intake connections at the back of the washer.

CAUTION The water supply hose connected to the HOT faucet must be connected to the hot water supply intake and the water hose connected to the COLD faucet must be connected to the COLD water supply intake.

5. Tighten the fittings by hand until they are snug, and then tighten them an additional two-thirds of a turn with a wrench.

 To ensure the correct water usage, connect both the HOT and COLD water faucets. If either or both are not connected, an "4C" (no fill) error can occur.

 If you do not want to use the HOT water supply hose, insert the water intake cap into the HOT water supply intake hole. In this case, you must select the Tap Cold option for the water temperature. If you select the Tap Cold option, all the lamps for the water temperature options are turned off.

CAUTION Confirm that the water supply hoses are not twisted or bent. If the hoses are twisted or bent, the hoses can leak and cause electric shock due to the water leakage.

6. Turn on the HOT and COLD water supplies and check all the water supply intake connections and the faucets for water leaks.

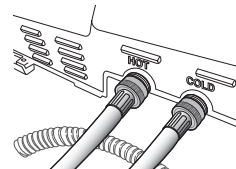
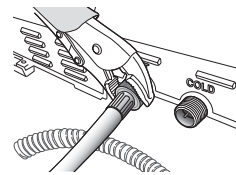
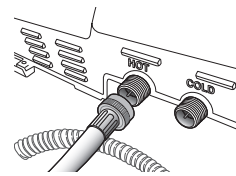
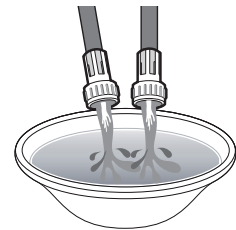
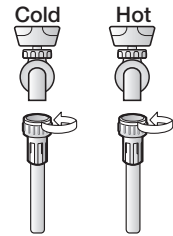
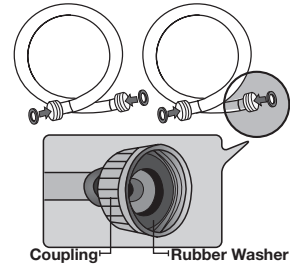

Connecting the drain hose

The end of the drain hose can be positioned in three ways:



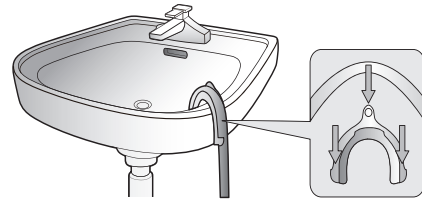

Over the edge of a wash basin

Secure the guide to the side of the basin wall with a hook or to the tap with a piece of string to prevent the drain hose from moving.



In a standpipe or laundry tub

The standpipe must be no shorter than 39 in (99 cm) and no longer than 96 in (245 cm).

-  Make sure that the connection between the drain hose and the standpipe is not airtight.
-  Connect the hose guide within 4 in (10cm) from the end of the drain hose. If the drain hose is extended more than 4 in (10cm) beyond the end of the hose guide, mold or microorganisms could spread to the inside of the washer.
-  The Drain Hose can be installed to a 96 in (245cm) maximum, but the draining capability can be reduced at this height. It can cause the washer to have an odor because of remaining water in the drain system.
-  If the drain hose is installed below 39 in (99cm), water can be drained in cycles due to a siphon phenomenon. It causes the washer to display a "4C" error code.

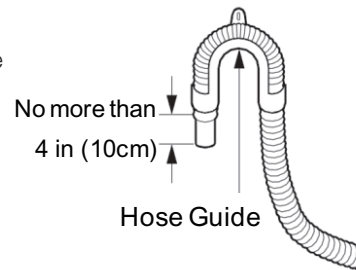
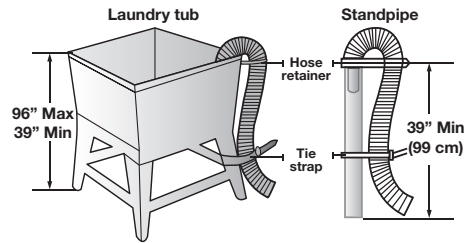

STEP 3

Leveling your washer

See if the washer is level by checking the position of the tub:

1. Slide the washer into position.
2. Open the lid of the washer, and pour the water into the tub to just below the pulsator level.

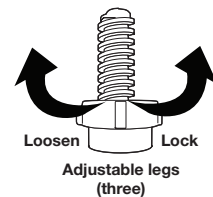
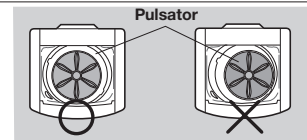

3. If the washer is level, the pulsator is positioned at the center of the water as shown in the figure. If not, level your washer by turning the front leveling feet clockwise or counterclockwise as necessary.

-  Turn the front leveling feet clockwise to raise the washer, and counterclockwise to lower the washer.

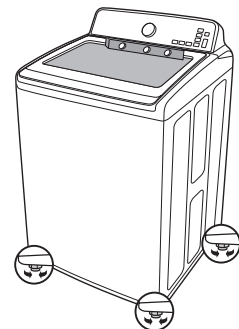

installing your washer

STEP 4

Powering your washer

Plug the power cord into a 3-prong, well grounded 120 volt 60 Hz approved electrical outlet protected by a 15-amp fuse or comparable circuit breaker.

Your washer is grounded through the third prong of the power cord when plugged into a three-prong grounded electrical outlet.

Test run

Make sure that you install your washing machine correctly by running the **Rinse+Spin** cycle after the installation is complete.

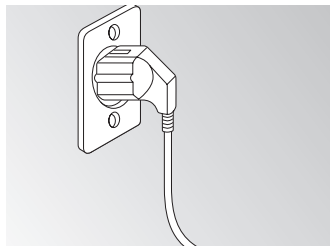

STEP 5

Running a test cycle

Run a test cycle as follows to check if your washer is properly installed.

1. Load about 6 pounds of laundry into the tub.
2. Press the **Power** button to turn on your washer.
3. Select the Rinse+Spin cycle by turning the **Cycle Selector**.
4. Press the **Start/Pause** button to start the test cycle.
5. The washer should not rock or vibrate excessively when water is supplied or when washing or spinning, and should drain well during the spin cycle.



If water leaks while water is being supplied or drained, check the water connections. Refer to the “Connecting the water and the drain” section on pages 14~15 for instructions.



If the washer rocks and vibrates excessively, level your washer again. Refer to the “Leveling your washer” section on page 15 for instructions.

STEP 6

Calibration Mode

Your Samsung washing machine detects the laundry weight automatically.

For more accurate weight detection, please run Calibration Mode after the installation.

To run Calibration Mode, follow these steps:

1. Remove laundry or any contents in the machine.
2. Press the Temp. and Delay End buttons more 3 seconds when the power is switched on.
3. Press the Start/Pause button to activate “Calibration Mode”.
4. The spin drum rotates clockwise approximately 2 minute.
5. When “Calibration Mode” is finished, “End” appears on the display, and the machine automatically turns off. The washing machine is now ready for use.

operating instructions

WARNING: To reduce the risk of fire, electric shock, or injury to persons when using your appliance, follow basic precautions, including the following:

LOADING YOUR WASHER

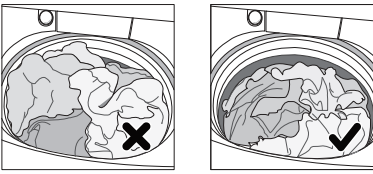
- You can fill the tub with dry, unfolded clothes, but **DO NOT OVERLOAD** the tub any more than 3/4 full.
 - Overloading may reduce washing efficiency, cause excess wear, and possibly cause creasing or wrinkling of the load.
 - Wash delicate items such as bras, hosiery, and other lingerie in the Delicates cycle with similar lightweight items.
 - When washing big bulky items or a few smaller items that don't fill the tub completely – a rug, a pillow, stuffed toys, or one or two sweaters, for example – add a few towels to improve spin performance.
 - Do not insert bulky items except for Bedding in this cycle.
- 
- ☑ During the spin cycle, the washer may add additional water to redistribute the clothes and correct an imbalance inside the drum.
 - When washing heavily soiled loads, do not overload your washer to ensure good cleaning results.
 - To add a forgotten item:
 1. Press the **Start/Pause** button to pause the washer.
 2. Wait for the door to unlock automatically, and then open the door.
 3. Add the item, close the door, and then press the **Start/Pause** button. The cycle will resume.

GETTING STARTED

1. Load your washer.
 2. Add liquid (or powder) detergent and additives to the dispenser (see pages 24~26).
 3. Select the appropriate cycle and options for the load (see pages 18~23).
 4. Close the lid.
 5. Press the **Start/Pause** button.
 6. The Wash Indicator light illuminates.
 7. The estimated cycle time will appear in the display.
The time may fluctuate to indicate the time remaining in the cycle.
- ☑ The actual time required for a cycle may differ from the estimated time in the display depending on the water pressure, water temperature, detergent, and laundry.
8. Before your washer starts to fill, it will make a series of clicking noises to check the door lock and do a quick drain.
- ☑
 - When the cycle is complete, the Door Lock light will go out and “End” will appear in the display.
 - Pressing the **Power** button cancels the cycle and stops your washer.
 - The Wash, Rinse, and Spin indicator lights will illuminate during those portions of the cycle.

washing a load of laundry

OVERVIEW OF THE CONTROL PANEL

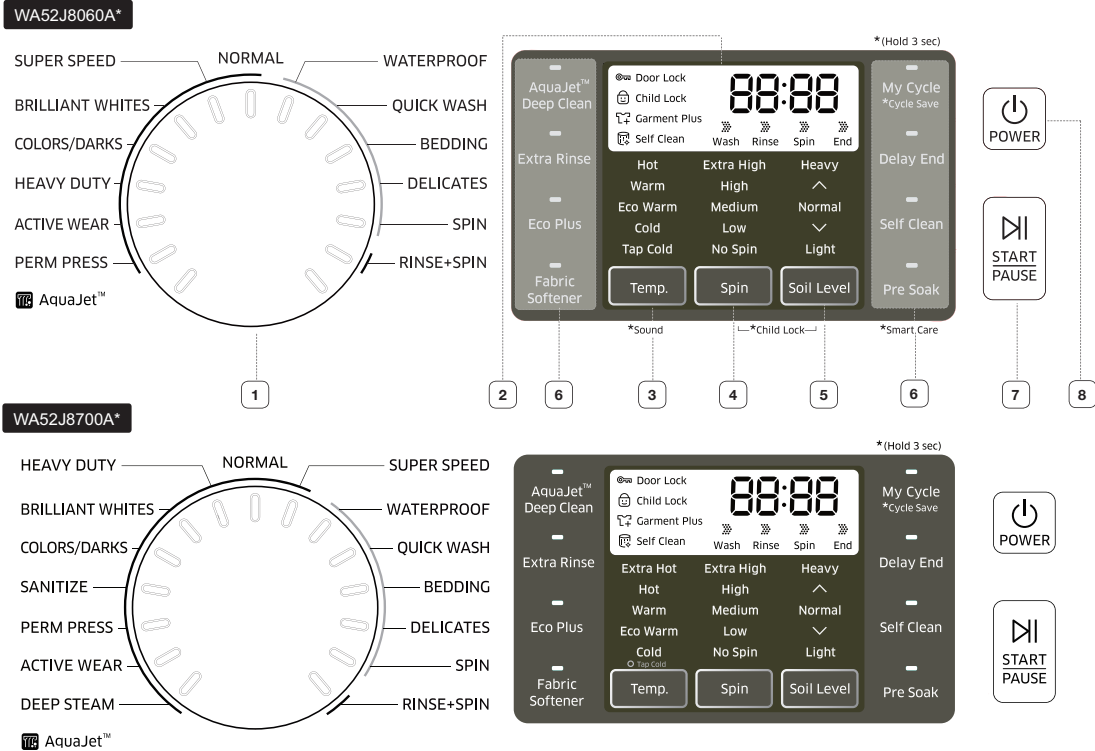

1 Cycle Selector

Select the appropriate cycle for the type of load. The cycle you select determines the tumble pattern and spin speed for the cycle.

To minimize wrinkling of laundry, select the Perm Press cycle.

NORMAL - For most fabrics including cottons, linens, and normally soiled garments.

SUPER SPEED - Lightly soiled and small loads.

BRILLIANT WHITES - Lightly soiled and small loads.

COLORS/DARKS - For brightly or dark colored casual garments.

HEAVY DUTY - For sturdy, colorfast fabrics and heavily soiled garments.

ACTIVE WEAR - Use this cycle to wash exercise wear such as sports jerseys, training pants, shirts/tops and other performance clothing. This cycle provides effective soil removal with gentle action for special fabric care.

PERM PRESS - For wash-and-wear, synthetic fabrics, and lightly to normally soiled garments.

DEEP STEAM (WA52J8700A*) - For heavily soiled, colorfast garments, this cycle provides a high washing temperature and steam and is effective for cleaning stains.

SANITIZE (WA52J8700A*) - For heavily soiled, colorfast garments.

WATERPROOF - For waterproof, water-resistant items.
 * Do not wash waterproof items and non-waterproof items together.
 * For waterproof, water-resistant items. (less than 14lbs)

QUICK WASH - For lightly soiled garments needed quickly. (another sentence all delete)

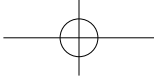

	<p>BEDDING - For bulky items such as blankets and sheets. When you are washing comforters, use liquid detergent.</p> <p>DELICATES - For sheer fabrics, bras, lingerie, silks, and other handwash-only fabrics. For best results, use liquid detergent.</p> <p>SPIN - Drains the water and spins at a high speed.</p> <p>RINSE + SPIN - Use for loads that need rinsing only or to add rinse-added fabric softener to a load.</p>
2 Display	Provides instructions and diagnostics while keeping you updated on the cycle status and time remaining.
3 Temp. selection button	<p>Press the button repeatedly to cycle through the different water temperature options.</p> <p>Extra Hot (WA52J8700A*) - Heavily soiled, colorfast items. Only available with the Sanitize cycle.</p> <p>Hot - Whites and heavily soiled, colorfast items.</p> <p>Warm - Colorfast items.</p> <p>Eco Warm - Moderately soiled, colorfast items; most wrinkle-free items.</p> <p>Cold - Brightly colored, very lightly soiled items.</p> <p>Tap Cold - Cold water with no warm water added.</p> <p>※ If you select the Tap Cold option, all the lamps for the water temperature options are turned off.</p>
4 Spin selection button	<p>Press the button repeatedly to cycle through the different spin speed options.</p> <p>Extra High - Removes more water from loads during spin.</p> <p>High - Use for underwear, t-shirts, jeans, and sturdy cottons.</p> <p>Medium - Use for jeans, wrinkle-free or wash-and-wear items, and synthetics.</p> <p>Low - Use for delicate items needing a slow spin speed.</p> <p>No Spin - Drains your washer without spinning. Use for extremely delicate items that cannot tolerate any spin.</p>
5 Soil Level selection button	<p>Press the button to select the soil level/washing time. (Light → ▼ → Normal → ▲ → Heavy)</p> <p>Heavy - For heavily soiled loads. ▲</p> <p>Normal - For moderately soiled loads. This setting is best for most loads. ▼</p> <p>Light - For lightly soiled loads.</p>
6 Select Cycle Option	<p>Press these buttons to select different cycle options.</p> <p>AquaJet™ Deep Clean – Improve washing performance through longer AquaJet spray action. Water Level can be adjusted.</p> <p>Extra Rinse - Change from spray rinse mode to deep rinse mode, and rinse once again.</p> <p>Eco Plus – To increase your energy savings on your wash cycles. (Less hot water consumption)</p> <p>Fabric Softener - Add an additional rinse at the end of the cycle to more thoroughly remove laundry additives and perfumes.</p> <p>My Cycle - Press and hold for 3 seconds to Save. Create and/or use a cycle you create with customized temperature, spin, soil level, option, etc.</p> <p>Delay End - Delay the End of any cycle for up to 19 hours in one-hour increments. Displayed hour indicates the time the wash will be ended.</p> <p>Self Clean - Use to clean dirt and bacteria from the drum. Regular use (after every 20 washes) is recommended. No detergent or bleach is needed.</p> <p>Pre Soak - It adds 15 minutes soaking time at the start of the wash cycle for better stain removal.</p>
7 Start/Pause selection button	Press to pause and restart cycles.
8 Power button	Press once to turn your washer on. Press again to turn your washer off. If the washer is left on for more than 10 minutes without any buttons being pressed, the power automatically turns off.

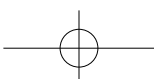
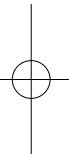
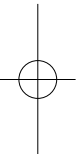

washing a load of laundry

Child Lock [🔒]

Child Lock prevents children from playing with your washer.

Activating the Child Lock function

Press and hold the **Spin** and **Soil Level** buttons simultaneously for approximately 3 seconds.

- When you activate the Child Lock function, the “Child Lock [🔒]” lamp blinks.

Using the Child Lock function

If the lid is opened when the Child Lock function is on, “dC” is displayed and an alarm sounds.

- If the water level in the tub is above the safe water level, “dC” is displayed on the LED display and the washing machine starts to drain water by force after 30 seconds.
- If the water level in the tub is above the safe water level and the Child Lock function is turned on while the door is open, “CL” is displayed on the LED display even if the power of the washing machine is turned off and the washing machine drains water by force.
- Even if the power of the washing machine is turned off, if the lid is opened while the water level in the tub is above the Reset water level, “CL” is displayed on the LED display without the alarm sounding and the washing machine starts to drain water. When the draining operation finishes, the power is automatically turned off again.
- You have activated the Child Lock function while the washing machine is running, the Start/Pause button will not work.
- After the compulsory drain, the “CL” code display blinks at 1 second intervals and the product enters the “CL” mode. (When the product is in the “CL” mode, only the **Power** button works.)
- To cancel the “CL” mode, you need to turn the power off and then on again.
- To cancel the “dC” mode, deactivate the Child Lock function. To deactivate the Child Lock function, press and hold the **Spin** and the **Soil Level** buttons simultaneously for at least 3 seconds.

Adding laundry when Child Lock is on

- To add laundry, deactivate the Child Lock function. To deactivate the Child Lock function, press and hold the **Spin** and the **Soil Level** buttons simultaneously for at least 3 seconds. See “Pause Option” on page 23 for additional details.

Deactivating the Child Lock function

Press and hold both the **Spin** and **Soil Level** buttons simultaneously for approximately 3 seconds.

- When you deactivate the Child Lock function, the “Child Lock [🔒]” is turned off.
- The Child Lock function prevents children or the infirm from accidentally operating the washer and injuring themselves.



- If a child enters the washing machine, the child may become trapped and suffocate.



- Once you have activated the Child Lock function, it continues working even if the power is turned off.
- Forcing the lid open can result in injury or damage to the product.

 To add laundry after you have activated the Child Lock function, you must first deactivate the Child Lock function.

Sound

The Sound Off function can be selected during all cycles.

Garment Plus



You can add or take out laundry items even after the wash has started, as long as the “**Garment Plus**” light is on. Pushing the **Start/Pause** button unlocks the lid. If you open the lid and want to continue the wash cycle, close the lid, and then press the **Start/Pause** button.

 If you have activated the Child Lock, you must deactivate it first. See page 20.

My Cycle

Lets you save a custom wash cycle (temperature, spin, soil level, etc.) and then recall and use it with one button convenience.

To save a cycle and selected options as your My Cycle, follow these steps:

1. Press the **Power** button.
2. Select a cycle using the **Cycle Selector**.
3. After cycle selection, set each option.
 -  See the “Cycle Chart” on page 35 for available option settings with each cycle.
4. You can then store the selected cycle and options by pressing and holding the **My Cycle** button for longer than 3 seconds. The cycle and options you select will be displayed the next time you choose the My Cycle function.
5. Press the My Cycle button to load and use the saved My Cycle options. The “My Cycle” light will indicate activation. Also, the chosen course and option lights will flicker.
 -  You can change the My Cycle settings by repeating the process above. The last saved settings will be displayed the next time you choose the My Cycle function.
 -  If you press My Cycle and release it within 3 seconds, the previously saved cycle and options appear. If you press and hold My Cycle for 3 second or longer, the currently set cycle and options are saved and the LED blinks for 3 seconds.

Delay End

You can set the washing machine to start your wash automatically at a later time, by choosing a delay time.

The hour displayed indicates the time at which the wash will be ended.

1. Set your wash cycle.
2. Press the **Delay End** button repeatedly until the delay time is set.
3. Press the **Start/Pause** button. The “Delay End” indicator will be lit, and the clock will begin counting down until it reaches the set time.
4. To cancel a Delay End function, press the **Power** button and then turn the washing machine on again.

washing a load of laundry

Pre Soak

Use this function when the laundry is heavily contaminated or stained. This function improves the wash performance by adding a Pre Soak cycle.

- If you select this function, the total cycle time is increased by 15 minutes.
- When the Pre Soak cycle starts, the washing machine repeats a wash cycle after supplying water and then performs a 15-minute soak cycle.
- When the Pre Soak cycle is complete, the configured wash cycle starts without draining water.

AquaJet™

With a strong spray and soapy water recirculated by the AquaJet™ pump, laundry can be more gently and thoroughly cleaned than in conventional Top Loads.

- AquaJet™ Deep Clean: If AquaJet™ Deep Clean mode is selected, washing performance can be further improved by the additional spray action. Sufficient water quantity can be ensured by adjusting the water level.

Cycles	AquaJet™ Deep Clean
NORMAL, SUPER SPEED, BRILLIANT WHITES, COLORS/DARKS, HEAVY DUTY, SANITIZE (WA52J8700A*), DEEP STEAM (WA52J8700A*), ACTIVE WEAR, PERM PRESS, RINSE+SPIN	Available
WATERPROOF, QUICK WASH, BEDDING, DELICATES, SPIN	Not Available

Eco Plus

This function sets the temperature somewhat lower than the typical washing cycle and extends the wash time slightly. With laundry time slightly extended, it's possible to keep the same level of washing performance with cooler water. This function reduces energy consumption and maintains the quality of the wash.

Mist Shower

Mist Shower sprays water from a nozzle that is independent of the main water supply system. It states that it soaks the laundry with water from the beginning of the rinse cycle and ensures an effective wash, but it's not part of the wash cycle, it's part of the rinse cycle, so this needs to state that it ensures an effective RINSE.

(The Mist Shower function may not work if there is too large of a load in the machine.)

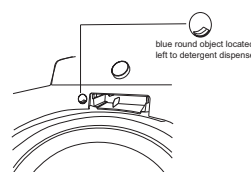

Smart Care

This function enables you to check the status of the washing machine using a smartphone.

1. To enable the Smart Care function, press and hold the Pre Soak key for 3 seconds after turning the power on or when an error occurs.
 - The error code history is deleted after you use this function.
2. The Smart Care indicator is lit on the display.
3. Run the Smart Care app on your smart phone.
 - Android:
Galaxy S series, Galaxy Note series. (Other devices may not be normal operation).
Supported OS : Android 2.2 or higher
 - iOS:
iPhone series
Supported OS : iOS 4.3 or higher
4. Focus your smart phone's camera on the display panel of the washing machine.
5. If the smart phone's camera is focused on the display panel of the washing machine, the panel and error message is automatically recognized and the error type and countermeasures are displayed on the smart phone.

- If the smartphone fails to recognize the error code more than twice, please enter the error code displayed on the display panel of the washer manually into the Smart Care app.



Downloading the Smart Care app

- Download the Samsung Laundry App into your mobile phone from the Android market or Apple App store. (Search word : Samsung Smart Washer/Dryer)



Precautions when using Smart Care

- If light from a light bulb, fluorescent bulb, or lamp is reflected on the display panel of the washing machine, the smartphone may not be able to recognize the panel or error message easily.
- If you hold the smartphone at too large an angle relative to the front of the display panel, it may not be able to recognize the error code. For best results, hold the smartphone so that the front of the panel and the smartphone are parallel or nearly parallel.

Washing clothes using the cycle selector

Your new washing machine makes washing clothes easy, using Samsung's "Fuzzy Control" automatic control system. When you select a wash program, the machine will set the correct temperature, washing time, and washing speed.

- Press the **Power** button.
- Open the lid.
- Load the articles of clothing one at a time loosely into the drum, without overfilling it.
- Add liquid (or powder) detergent, softener, and/or bleach (if necessary) to the appropriate compartments. See pages 24~26.
- Close the lid.
- Use the Cycle Selector to select the appropriate cycle according to the type of material: NORMAL, HEAVY DUTY, COLORS/DARKS, PERM PRESS, ACTIVE WEAR, SUPER SPEED, BRILLIANT WHITE, WATERPROOF, BEDDING, QUICK WASH, DELICATES, SPIN, and RINSE+SPIN. The relevant indicators will illuminate on the control panel.
- At this time, you can control the wash temperature, the number of rinse cycles, the spinning speed, and the delay time by pressing the appropriate option button.
- Press the **Start/Pause** button on the Cycle Selector and the wash will begin. The process indicator will light up and the remaining time for the cycle will appear in the display.

Pause Option

To remove or add laundry items, follow these steps:

- Press the **Start/Pause** button to unlock the lid.
- The lid cannot be opened when the water is too HOT.
- Remove or add laundry items.
- Close the lid, and then press the **Start/Pause** button to restart the wash.
- If you have Child Lock on, you must deactivate it first. See page 21.

When the cycle is finished:

After the total cycle has finished, the power will turn off automatically.3

- Open the lid.
- Remove laundry.

ATC (AUTO TEMPERATURE CONTROL)

ATC is the control function that the washer controls water temperature with temperature sensor (thermistor).



Because there are numerous water temperatures depending on the customer's environments (cold areas, warm areas, various water temperatures, settings of heater temperature, etc.), ATC function in our washer maintains the certain level of wash temperature to output the best washing performance at each cycle.



If you select normal cycle, this cycle is the regulation and UL cycle. Since new washers must reduce the amount of energy usage as a first priority, customers will notice more cold water entering the washer. But, this is normal, not a problem.



In this regulation cycle, Hot temperature is similar to acceptable adult bath-water temperature and warm temperature is similar to comfortable swimming-pool water temperature. If customers want to wash clothes in specific water temperatures, customers should choose a different cycle at each temperature (Hot/Warm/Eco Warm).

washing a load of laundry

PREWASH : WATER JET & BUILT-IN SINK (WA52J8700A*)

Water Jet and Built-in sink help you hand-wash before the washing machine starts operation. Water Jet is available only when the door is open with the water level set to less than High. For prewashing, use the Built-in sink that is designed to facilitate the hand-wash.

1. With the door open, lower the Built-in sink, and put clothes to prewash on it.
2. Press **Water Jet** to supply water to the Built-in sink, and hand-wash.



- If you want to hand-wash while the machine is operating, press Start/Pause to stop operation, and then follow steps 1-2 above.
- If you open both the door and the Built-in sink, lower the Built-in sink manually for prewashing.



- Do not abuse Water Jet. Excessive use of Water Jet increases water consumption.
- When running water to the tub, do that gently. Otherwise, water may overflow the tub.

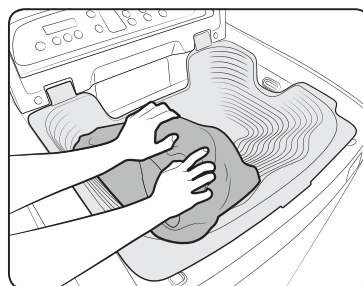
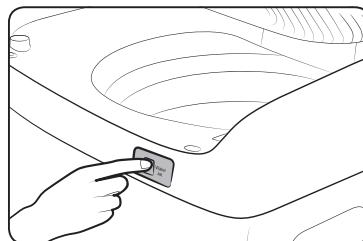

DETERGENT USE

Your washer is designed to use high efficiency (HE) detergents.

- For the best cleaning results, use a high efficiency detergent such as Tide HE, Wisk HE, Cheer HE or Gain HE*. High efficiency detergents contain suds suppressors that reduce or eliminate suds. When fewer suds are produced, the load tumbles more efficiently and cleaning is maximized.



Regular detergent is not recommended. Use HE detergents only.



Reducing the amount of detergent may reduce the quality of cleaning. It is important to pre-treat stains, sort carefully by color and soil level, and avoid overloading.

* Brand names are trademarks of their respective manufacturers.

FEATURES

Automatic dispenser

Your washer has separate compartments for dispensing detergent and color-safe bleach and fabric softener. Add all laundry additives to their respective compartments before starting your Washer.

The automatic dispenser **MUST ALWAYS** be in place before you start your washer.

DO NOT open the automatic dispenser when your washer is running.



- Never exceed the manufacturer's recommendations when adding detergent.
- This compartment holds liquid detergent for the main wash cycle, which is added to the load at the beginning of the cycle.
- When using powdered detergent, remove the liquid detergent compartment from the detergent drawer. The washer will not dispense powdered detergent from the liquid detergent compartment.

To add detergent to the automatic dispenser:

1. Open the dispenser drawer.
2. Load the recommended amount of liquid (or powder) detergent into the detergent compartment before you start your wash.
3. Close the drawer slowly and smoothly to avoid spilling, splashing, or premature dispensing of the contents.



It is normal for a small amount of water to remain in the dispenser compartments at the end of the cycle.



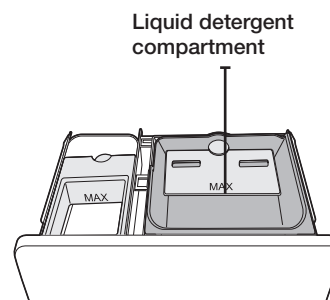

Do not put chlorine bleach in the dispenser drawer.



washing a load of laundry

Loading the Liquid (or Powder) detergent compartment

1. Pour the recommended amount of laundry detergent directly into the detergent compartment before starting your washer.
2. If you are using color-safe bleach, add it with the detergent to the detergent compartment.

-  When adding color-safe bleach with detergent, it is best if both laundry products are in the same form – liquid.
-  When using powdered detergent, remove the liquid detergent compartment from the detergent drawer. The washer will not dispense powdered detergent from the liquid detergent compartment.

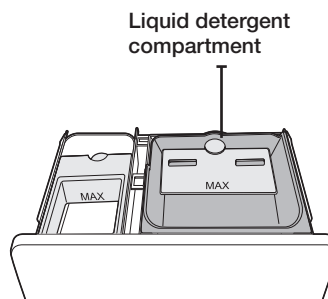

Loading the Bleach compartment (WA52J8060A*)

(Liquid chlorine bleach only)

1. Add chlorine bleach to the bleach compartment.
DO NOT exceed the MAX FILL line.
- 
 - Avoid splashing or over-filling the compartment.
 - Your washer automatically dispenses bleach into the tub at the appropriate time.
2. The dispenser automatically dilutes liquid chlorine bleach before it reaches the wash load.
 - Never pour undiluted liquid chlorine bleach directly onto the load or into the tub. It is a powerful chemical and can cause fabric damage, such as weakening of the fibers or color loss, if not used properly.
 - If you prefer to use color-safe, non-chlorine bleach, add it to the appropriate detergent compartment.
DO NOT pour color-safe bleach into the Bleach compartment.

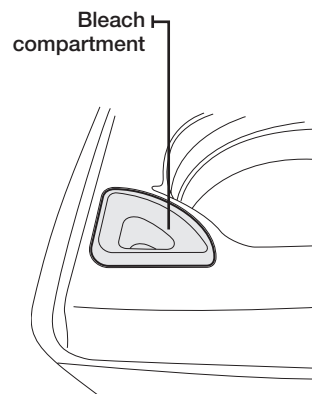

Loading the Bleach compartment (WA52J8700A*)

(Liquid chlorine bleach only)

Add chlorine bleach to the bleach compartment.

DO NOT exceed the bleach compartment.

- Avoid splashing or over-filling the compartment.
- 
 - Never pour undiluted liquid chlorine bleach directly onto the load or into the tub. It is a powerful chemical and can cause fabric damage, such as weakening of the fibers or color loss, if not used properly.
 - If you prefer to use color-safe, non-chlorine bleach, add it to the appropriate detergent compartment.
DO NOT pour color-safe bleach into the Bleach compartment.

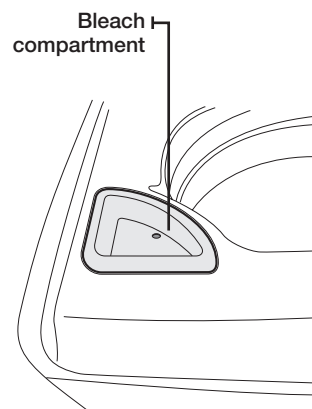

Loading the Fabric softener compartment

1. Pour the recommended amount of liquid fabric softener into the softener compartment.
For smaller loads, use less than one capful.
2. Dilute the fabric softener with water until it reaches MAX FILL in the compartment.
3. The dispenser automatically releases liquid fabric softener at the proper time during the rinse cycle.



- Use the softener compartment **ONLY** for liquid fabric softeners.
 - **DO NOT** use the Downy Ball* in the fabric softener compartment with this washer. It will not add fabric softener at the appropriate time. Use the detergent compartment.
 - Do not use liquid fabric softener that is too sticky as it may not mix with the water sufficiently.
- * Brand names are trademarks of their respective manufacturers.

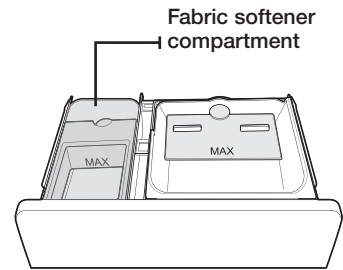

maintaining your washer

CLEANING THE EXTERIOR

Turn off the water faucets after finishing the day's washing.

This will shut off the water supply to your washer and prevent the unlikely possibility of damage from escaping water. Leave the lid open to allow the inside of your washer to dry out.

Use a soft cloth to wipe up all detergent, bleach or other spills as they occur.

Clean the following as recommended:

Control Panel – Clean with a soft, damp cloth. Do not use abrasive powders or cleaning pads. Do not spray cleaners directly on the panel.

CLEANING THE INTERIOR

Clean the interior of your washer periodically to remove any dirt, soil, odor, mold, mildew, or bacterial residue that may remain in your washer as a result of washing clothes.

Failure to follow these instructions may result in unpleasant conditions, including odors and/or permanent stains on your washer or laundry.

Hard water deposits may be removed, if needed. Use cleaners labeled "Washer safe".

STORING YOUR WASHER

Washers can be damaged if water is not removed from hoses and internal components before storage.

Prepare your washer for storage as follows:

- Select the Quick Wash cycle and add bleach to the automatic dispenser. Run your washer through the cycle without a load.
- Turn the water faucets off and disconnect the inlet hoses.
- Unplug your washer from the electrical outlet and leave your washer lid open to let air circulate inside the drum.
- If your washer has been stored in below-freezing temperatures, allow time for any leftover water in your washer to thaw out before use.

PRESERVING THE TOP COVER AND THE FRONT FRAME

Do not place any heavy or sharp objects or a detergent box on the washing machine. They can scratch or damage the top cover of the unit.

-  Since the entire washing machine has a high-gloss finish, the surface can be scratched or damaged. Avoid scratching or damaging the surface when using the washing machine.

CLEANING THE DISPENSERS

The automatic dispenser may need to be cleaned periodically due to laundry additive buildup.

1. Pull the dispenser drawer straight back until it stops.



2. Push the ends of each side of the case at the same time. When you feel the ends push, pull out the dispenser drawer.

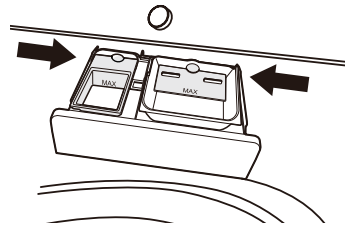

3. Remove the inserts from the 3 compartments. Rinse the inserts and the drawer with warm water to remove traces of accumulated laundry products.

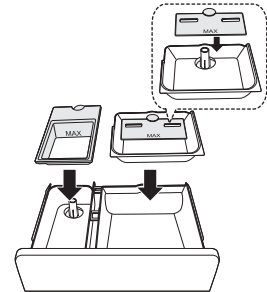

4. To clean the drawer opening, use a small, non-metal brush to clean the recess. Remove all residue from the upper and lower parts of the recess.

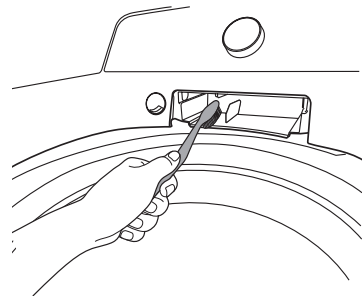

5. Return the inserts to the proper compartments and replace the drawer. By placing the dispenser drawer rail ② on top of the compartment rail ① (Tilt the dispenser drawer downward and insert it.), and then push the drawer in firmly and slowly.

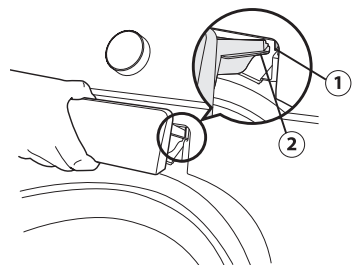

maintaining your washer

SELF CLEAN

Self Clean is a self-cleaning cycle that removes mold that may occur inside the washing machine.

1. Press the **Power** button.
2. Select the **Self Clean** cycle.
 - Once the **Self Clean** cycle is selected, the only function that can be set is Delay End.
3. Press the **Start/Pause** button.
 - If you press the **Start/Pause** button, Self Clean begins.

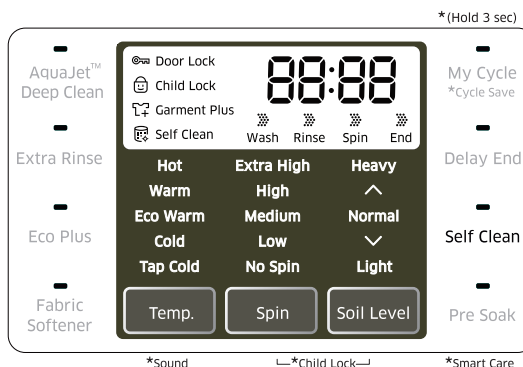

- CAUTION**
- Using Self Clean, you can clean the drum without using a cleansing agent.
 - Never use Self Clean when laundry is in the washing machine. This may cause damage to the laundry or a problem with the washing machine.

The Self Clean Auto Indicator Function

- If the “**Self Clean**” indicator is lit after a wash, it indicates that tub (drum) cleaning is required. In this case, remove the laundry from the washing machine, turn the power on, and clean the drum by running Self Clean.
- If you do not run Self Clean, the “**Self Clean**” indicator turns off. However, the “**Self Clean**” indicator will light again after two washes. Not running Self Clean at this point will not cause a problem with the washing machine.
- Although the Self Clean Auto Indicator appears once a month or so, the frequency may differ depending on the number of times the washing machine is used.

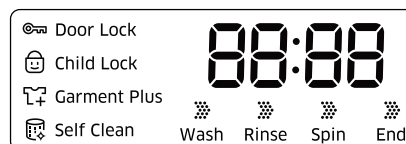

troubleshooting

CHECK THESE SOLUTIONS IF YOUR WASHER...



PROBLEM	SOLUTION
Will not start.	<ul style="list-style-type: none">• Make sure the lid is closed.• Make sure your washer is plugged in.• Make sure the water source faucets are open.• Make sure to press the Start/Pause button to start your Washer.• Make sure Child Lock is not activated. See page 20.• Before your washer starts to fill, it will make a series of clicking noises to check the lid lock and do a quick drain.• Check the fuse or reset the circuit breaker.
Has no water or not enough water.	<ul style="list-style-type: none">• Turn both faucets on fully.• Straighten the water inlet hoses.• Disconnect hoses and clean the screens. Hose filter screens may be clogged.• You use the optimum water required for cleaning, but if you use the Niagara Wash cycle, you are using more water than compared to the Normal cycle. The cycle then proceeds to the Normal cleaning and rinse levels.
Has detergent remaining in the automatic dispenser after the wash cycle is complete.	<ul style="list-style-type: none">• Make sure your washer is running with sufficient water pressure.
Vibrates or is too noisy.	<ul style="list-style-type: none">• Make sure your washer is set on a level surface. If the surface is not level, adjust your washer's feet to level the appliance.• Make sure your washer is not touching any other object.• Make sure the laundry load is balanced.
Stops	<ul style="list-style-type: none">• Plug the power cord into a live electrical outlet.• Check the fuse or reset the circuit breaker.• Close the lid and press the Start/Pause button to start your washer. For your safety, your washer will not spin unless the lid is closed.• Before your washer starts to fill, it will make a series of clicking noises to check the lid lock and do a quick drain.• There may be a pause or soak period in the cycle. Wait and it may start.• Check the screens on the inlet hoses at the faucets for obstructions. Clean the screens periodically.

troubleshooting

PROBLEM	SOLUTION
Fills with the wrong temperature water.	<ul style="list-style-type: none"> • Turn both faucets on fully. • Make sure the temperature selection is correct. • Make sure the hoses are connected to the correct faucets. Flush water lines. • Disconnect the hoses and clean the screens. The hose filter screens may be plugged. • As your washer is filling, the water temperature may change as the automatic temperature control feature checks incoming water temperature. This is normal. • While your washer is filling, you may notice just hot and/or just cold water going through the dispenser when you have selected cold or warm wash temperatures. This is a normal function of the automatic temperature control feature as your washer determines the temperature of the water.
Lid locked or will not open.	<ul style="list-style-type: none"> • Press the Start/Pause button to stop your washer. • It may take a few moments for the lid lock mechanism to disengage.
Does not drain and/or spin.	<ul style="list-style-type: none"> • Check the fuse or reset the circuit breaker. • Straighten the drain hoses. Eliminate kinked hoses. If there is a drain restriction, call for service. • Close the lid and press the Start/Pause button. For your safety, your washer will not spin unless the lid is closed.
Load is too wet at the end of the cycle.	<ul style="list-style-type: none"> • Use the High spin speed. • Use high efficiency detergent to reduce over-sudsing. • The Load is too small. Very small loads (one or two items) may become unbalanced and not spin out completely.
Leaks water.	<ul style="list-style-type: none"> • Make sure all hose connections are tight. • Make sure the end of the drain hose is correctly inserted and secured to the drainage system. • Avoid overloading. • Use high efficiency detergent to prevent over-sudsing.
Has excessive suds.	<ul style="list-style-type: none"> • Use high efficiency detergent to prevent over-sudsing. • Reduce the detergent amount for soft water, small or lightly soiled loads. • Non-HE detergent is NOT recommended.
Has an odor.	<ul style="list-style-type: none"> • Check your Detergent . Excessive suds collect in nooks and crannies and cause mold. • Run cleansing cycles to sanitize the machine periodically. (Self Clean) • Dry the interior of your washer after the total cycle has finished.

INFORMATION CODES

The Washer may display information codes to help you understand what is occurring with your Washer better.

CODE SYMBOL	MEANING	SOLUTION
1C	The Water Level sensor is not working properly.  When the washer displays the "1C" code, the washer do draining for 3 minutes. During this time, the Power button is inoperative.	Call for service.
4C	Your Washer has tried to fill but was unsuccessful. Check if the hot water supply hose is connected.  When the washer displays the "4C" code, the washer do draining for 3 minutes. During this time, the Power button is inoperative.	Make sure the water faucets are open all the way. Check for kinked hoses. Check the inlet screens on the fill hoses. If you use a Flood Safety Device, then please remove the device and connect the water hoses directly to the unit. You must connect the hot water supply hose because hot water is supplied by the Auto Temperature Control (A.T.C.) function.
5C	Your washer is not draining. It can also mean that the unit senses a small clog while draining.	Do the following: 1) Turn off the unit and turn it on again. 2) Select only the Spin Cycle. 3) Press the Start/Pause to drain the water. If it still does not drain, call for service.
LC	Your Washer has tried to fill but has not reached the proper water level.  When the washer displays the "LC" code, the washer do draining for 3 minutes. During this time, the Power button is inoperative.	Call for service.
UB	Unbalanced load prevented your Washer from spinning.	Redistribute the load, press the Start/Pause button.
dC	Lid is open when washer is running.	Close the lid tightly and restart the cycle. If the code reappears, call for service.
dC1	Your washer failed to lock the lid.	Close the lid tightly and restart the cycle. If the code reappears, call for service.
	The door will not unlock.	Make sure the lid is firmly closed. Push the Power button to turn off your washer, then turn it on again. If the code reappears, call for service.
bC2	Jammed Key.	Call for service.

troubleshooting































CODE SYMBOL	MEANING	SOLUTION
3C	Motor not running properly.	Restart the cycle pressing the Start/Pause button. If the code reappears, call for service.
AC	Communication error between SUB PBA and MAIN PBA.	Call for service.
8C 8C2	Mems sensor problem.	Call for service.
tC1	Temperature sensor problem.	Restart the cycle. If the code reappears, call for service.
OC	A fault is detected in the water level sensor.	Call for service.
4C2	This occurs when the temperature exceeds 50, for over 8 seconds in the Wool and Delicates course.	Call for service.
PC	When position of the clutch can't be detected.	Call for service.
PC1	After position of the clutch is detected, if the signal of the clutch hall goes wrong, occurs error.	Call for service.

For any codes not listed above, call 1-800-726-7864 (1-800-SAMSUNG).

appendix

FABRIC CARE CHART

The following symbols provide garment care direction. The Clothing care labels include symbols for washing, bleaching, drying and ironing, or dry cleaning when necessary. The use of symbols ensures consistency among garment manufacturers of domestic and imported items. Follow care label directions to maximize garment life and reduce laundering problems.

Wash Cycle		Special Instructions		Warning Symbols for Laundering	
	Normal		Line Dry/ Hang to Dry		Do Not Wash
	Permanent Press / Wrinkle Resistant / Wrinkle Control		Drip Dry		Do Not Wring
	Gentle/Delicates		Dry Flat		Do Not Bleach
	Hand Wash	Heat Setting			Do Not Tumble Dry
Water Temperature**			High		No Steam (added to iron)
•••	Hot		Medium		Do Not Iron
••	Warm		Low	Dryclean	
•	Cold		Any Heat		Dry Clean
Bleach			No Heat/Air		Do Not Dry Clean
	Any Bleach (when needed)	Iron-Dry or Steam Temperatures			Line Dry/ Hang to Dry
	Only Non-Chlorine (color-safe) Bleach (when needed)		High		Drip Dry
	Tumble Dry Cycle		Medium		Dry Flat
Normal			Low		
	Permanent Press/ Wrinkle Resistant/ Wrinkle Control				
	Gentle/ Delicates				

** The dot symbols represent appropriate wash water temperatures for various items. The temperature range for Hot is 105° - 125 °F / 41° - 52 °C, for Warm 85° - 105 °F / 29° - 41 °C and for Cold 60° - 85 °F / 16° - 29 °C. (Wash water temperature must be a minimum of 60 °F / 16 °C for detergent activation and effective cleaning.) The clothes washer can not ensure these temperatures because the actual temperature of the water entering your washer depends on water heater settings and regional water supply temperatures. For example, cold water entering the home in the northern states during winter may be 40 °F / 4 °C which is too cold for effective cleaning. In this situation, you will need to adjust the water temperature by selecting a warm setting, adding some hot water to the MAX FILL line, or using your Washer's heating option, if available.

appendix

CYCLE CHART

Use this chart to set the best cycle and options for you laundry.

WA52J8060A*

(●: factory setting, ●: selectable)

Course	Temp.					Spin					Soil Level				
	H	W	EW	C	TC	EH	H	M	L	NS	H	▲	N	▼	L
NORMAL	●	●	●	●	●	●	●	●		●	●	●	●	●	●
SUPER SPEED	●	●	●	●	●	●	●	●	●	●	●	●	●	●	●
BRILLIANT WHITES	●	●	●	●	●	●	●	●	●	●	●	●	●	●	●
COLORS/DARKS		●	●	●	●	●	●	●	●	●	●	●	●	●	●
HEAVY DUTY	●	●	●	●	●	●	●	●	●	●	●	●	●	●	●
ACTIVE WEAR		●	●	●	●	●	●	●	●	●			●	●	●
PERM PRESS	●	●	●	●	●	●	●	●	●	●	●	●	●	●	●
WATERPROOF	●	●	●	●	●				●	●	●	●	●	●	●
QUICK WASH	●	●	●	●	●	●	●	●	●	●	●	●	●	●	●
BEDDING	●	●	●	●	●		●	●	●	●	●	●	●	●	●
DELICATES		●	●	●	●			●	●	●					●
SPIN						●	●	●	●	●					
RINSE+SPIN						●	●	●	●	●					
SELF CLEAN	●							●							

Course	Options						
	AquaJet™ Deep Clean	Extra Rinse	Eco Plus	Fabric Softener	My cycle	Delay End	Pre Soak
NORMAL	●	●	●	●	●	●	●
SUPER SPEED	●	●		●	●	●	
BRILLIANT WHITES	●	●	●	●	●	●	●
COLORS/DARKS	●	●	●	●	●	●	●
HEAVY DUTY	●	●	●	●	●	●	●
ACTIVE WEAR	●	●	●	●	●	●	●
PERM PRESS	●	●	●	●	●	●	●
WATERPROOF		●		●	●	●	●
QUICK WASH		●		●	●	●	
BEDDING		●		●	●	●	●
DELICATES		●		●	●	●	
SPIN					●	●	
RINSE+SPIN	●	●		●	●	●	
SELF CLEAN					●	●	

Temp.	Spin	Soil Level
H: Hot	EH: Extra High	H: Heavy
W: Warm	H: High	▲: Normal
EW: Eco Warm	M: Medium	N: Normal
C : Cold	L: Low	▼: Light
TC : Tap Cold	NS: No Spin	L: Light

CYCLE CHART

Use this chart to set the best cycle and options for you laundry.

WA52J8700A*

(●: factory setting, ●: selectable)

Course	Temp.						Spin					Soil Level				
	EH	H	W	EW	C	TC	EH	H	M	L	NS	H	▲	N	▼	L
NORMAL	●	●	●	●	●	●	●	●	●		●	●	●	●	●	●
SUPER SPEED		●	●	●	●	●	●	●	●		●	●	●	●	●	●
BRILLIANT WHITES		●	●	●	●	●	●	●	●		●	●	●	●	●	●
COLORS/DARKS			●	●	●	●	●	●	●		●	●	●	●	●	●
HEAVY DUTY		●	●	●	●	●	●	●	●		●	●	●	●	●	●
ACTIVE WEAR			●	●	●	●	●	●	●		●	●	●	●	●	●
PERM PRESS		●	●	●	●	●	●	●	●		●	●	●	●	●	●
SANITIZE	●						●	●	●		●	●	●	●	●	●
DEEP STEAM	●						●	●	●		●	●	●	●	●	●
WATERPROOF		●	●	●	●	●			●		●	●	●	●	●	●
QUICK WASH		●	●	●	●	●	●	●	●		●	●	●	●	●	●
BEDDING		●	●	●	●	●		●	●		●	●	●	●	●	●
DELICATES			●	●	●	●		●	●		●	●	●	●	●	●
SPIN							●	●	●		●					
RINSE+SPIN							●	●	●		●					
SELF CLEAN		●							●							

Course	Options						
	AquaJet™ Deep Clean	Extra Rinse	Eco Plus	Fabric Softener	My cycle	Delay End	Pre Soak
NORMAL	●	●	●	●	●	●	●
SUPER SPEED	●	●		●	●	●	
BRILLIANT WHITES	●	●	●	●	●	●	●
COLORS/DARKS	●	●	●	●	●	●	●
HEAVY DUTY	●	●	●	●	●	●	●
ACTIVE WEAR	●	●	●	●	●	●	●
PERM PRESS	●	●	●	●	●	●	●
SANITIZE	●	●		●	●	●	●
DEEP STEAM	●	●		●	●	●	●
WATERPROOF		●		●	●	●	●
QUICK WASH		●		●	●	●	
BEDDING		●	●	●	●	●	●
DELICATES		●		●	●	●	
SPIN					●	●	
RINSE+SPIN	●	●		●	●	●	
SELF CLEAN						●	

Temp.	Spin	Soil Level
EH: Extra Hot H: Hot W: Warm EW: Eco Warm C: Cold TC: Tap Cold	EH: Extra High H: High M: Medium L: Low NS: No Spin	H: Heavy ▲: High N: Normal ▼: Low L: Light

appendix

HELPING THE ENVIRONMENT

- Your washer is manufactured from recyclable materials. If you decide to dispose of it, please observe local waste disposal regulations. Cut off the power cord so that the appliance cannot be connected to a power source. Remove the lid so that animals and small children cannot get trapped inside the appliance.
- Do not exceed the detergent quantities recommended in the detergent manufacturers' instructions.
- Use stain removal products and bleaches before the wash cycle only when necessary.
- Save water and electricity by only washing full loads (the exact amount depends upon the program used).

DECLARATION OF CONFORMITY

This appliance complies with UL2157.

SPECIFICATION

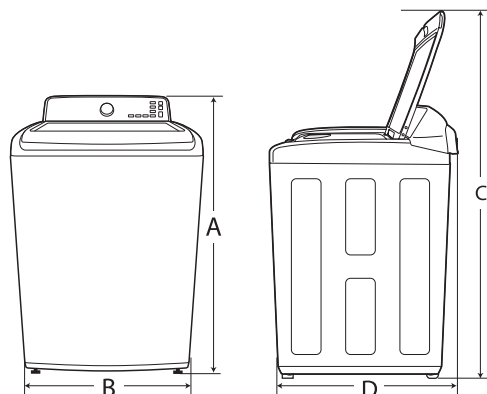

TYPE		TOP LOADING WASHER	
DIMENSIONS	Div		Inches (cm)
	A. Height		45.7" (116.0)
	B. Width		27.0" (68.6)
	C. Height with lid open		59.8" (152.0)
D. Depth		29.3" (74.4)	
WATER PRESSURE		20-116 psi (137-800 kPa)	
NET WEIGHT		65.0 kg (143.3 lb)	
SPIN REVOLUTION		1100 rpm	
POWER CONSUMPTION	WASHING	120 V	700 W
	SPIN	120 V	400 W
	DRAIN	120 V	80 W

warranty (U.S.A)

SAMSUNG WASHER

LIMITED WARRANTY TO ORIGINAL PURCHASER

This SAMSUNG brand product, as supplied and distributed by SAMSUNG ELECTRONICS AMERICA, INC. (SAMSUNG) and delivered new, in the original carton to the original consumer purchaser, is warranted by SAMSUNG against manufacturing defects in materials and workmanship for a limited warranty period of: One (1) year part and labor, Two (2) years Control Board Parts (Part Only), Three (3) years stainless tub part (Part Only), Five (5) years washing motor part (Part Only), Ten (10) years washing DD motor part (Part Only). This limited warranty begins on the original date of purchase, and is valid only on products purchased and used in the United States. To receive warranty service, the purchaser must contact SAMSUNG for problem determination and service procedures. Warranty service can only be performed by a SAMSUNG authorized service center. The original dated bill of sale must be presented upon request as proof of purchase to SAMSUNG or SAMSUNG's authorized service center. SAMSUNG will provide in-home service during the warranty period at no charge, subject to availability within the contiguous United States. In-home service is not available in all areas.

To receive in-home service, product must be unobstructed and accessible to the service agent. If service is not available, SAMSUNG may elect to provide transportation of the product to and from an authorized service center.

SAMSUNG will repair, replace, or refund this product at our option and at no charge as stipulated herein, with new or reconditioned parts or products if found to be defective during the limited warranty period specified above. All replaced parts and products become the property of SAMSUNG and must be returned to SAMSUNG. Replacement parts and products assume the remaining original warranty, or ninety (90) days, whichever is longer. This limited warranty covers manufacturing defects in materials and workmanship encountered in normal, noncommercial use of this product and shall not apply to the following: damage that occurs in shipment; delivery and installation; applications and uses for which this product was not intended; altered product or serial numbers; cosmetic damage or exterior finish; accidents, abuse, neglect, fire, water, lightning, or other acts of nature or God; use of products, equipment, systems, utilities, services, parts, supplies, accessories, applications, installations, repairs, external wiring or connectors not supplied or authorized by SAMSUNG that damage this product or result in service problems; incorrect electrical line voltage, fluctuations and surges; customer adjustments and failure to follow operating instructions, maintenance and environmental instructions that are covered and prescribed in the instruction book; product removal and reinstallation; problems caused by pest infestations. This limited warranty does not cover problems resulting from incorrect electric current, voltage or supply, light bulbs, house fuses, house wiring, cost of a service call for instructions, or fixing installation errors. SAMSUNG does not warrant uninterrupted or error-free operation of the product.

warranty (U.S.A)

EXCEPT AS SET FORTH HEREIN, THERE ARE NO WARRANTIES ON THIS PRODUCT EITHER EXPRESS OR IMPLIED, AND SAMSUNG DISCLAIMS ALL WARRANTIES INCLUDING, BUT NOT LIMITED TO, ANY IMPLIED WARRANTIES OF MERCHANTABILITY, INFRINGEMENT OR FITNESS FOR A PARTICULAR PURPOSE.

NO WARRANTY OR GUARANTEE GIVEN BY ANY PERSON, FIRM, OR CORPORATION WITH RESPECT TO THIS PRODUCT SHALL BE BINDING ON SAMSUNG. SAMSUNG SHALL NOT BE LIABLE FOR LOSS OF REVENUE OR PROFITS, FAILURE TO REALIZE SAVINGS OR OTHER BENEFITS, OR ANY OTHER SPECIAL, INCIDENTAL OR CONSEQUENTIAL DAMAGES CAUSED BY THE USE, MISUSE, OR INABILITY TO USE THIS PRODUCT, REGARDLESS OF THE LEGAL THEORY ON WHICH THE CLAIM IS BASED, AND EVEN IF SAMSUNG HAS BEEN ADVISED OF THE POSSIBILITY OF SUCH DAMAGES.

NOR SHALL RECOVERY OF ANY KIND AGAINST SAMSUNG BE GREATER IN AMOUNT THAN THE PURCHASE PRICE OF THE PRODUCT SOLD BY SAMSUNG AND CAUSING THE ALLEGED DAMAGE. WITHOUT LIMITING THE FOREGOING, PURCHASER ASSUMES ALL RISK AND LIABILITY FOR LOSS, DAMAGE, OR INJURY TO PURCHASER AND PURCHASER'S PROPERTY AND TO OTHERS AND THEIR PROPERTY ARISING OUT OF THE USE, MISUSE, OR INABILITY TO USE THIS PRODUCT. THIS LIMITED WARRANTY SHALL NOT EXTEND TO ANYONE OTHER THAN THE ORIGINAL PURCHASER OF THIS PRODUCT, IS NONTRANSFERABLE AND STATES YOUR EXCLUSIVE REMEDY.

Some states do not allow limitations on how long an implied warranty lasts, or the exclusion or limitation of incidental or consequential damages, so the above limitations or exclusions may not apply to you. This warranty gives you specific rights, and you may also have other rights, which vary from state to state.

To obtain warranty service, please contact SAMSUNG at:

Samsung Electronics America, Inc.

85 Challenger Road

Ridgefield Park, NJ 07660

1-800-SAMSUNG (726-7864)

www.samsung.com/us/support

Visits by a Service Engineer to explain functions, maintenance or installation is not covered by warranty.

Please contact your Samsung call agent for help with any of these issues.

warranty (CANADA)

SAMSUNG WASHER

LIMITED WARRANTY TO ORIGINAL PURCHASER

This SAMSUNG brand product, as supplied and distributed by SAMSUNG ELECTRONICS CANADA, INC. (SAMSUNG) and delivered new, in the original carton to the original consumer purchaser, is warranted by SAMSUNG against manufacturing defects in materials and workmanship for a limited warranty period of:

One (1) year part and labor, Ten (10) years washing DD motor (Part only).

This limited warranty begins on the original date of purchase, and is valid only on products purchased and used in the Canada. To receive warranty service, the purchaser must contact SAMSUNG for problem determination and service procedures. Warranty service can only be performed by a SAMSUNG authorized service center. The original dated bill of sale must be presented upon request as proof of purchase to SAMSUNG or SAMSUNG's authorized service center. SAMSUNG will provide in-home service during the warranty period at no charge, subject to availability within the Canada. In-home service is not available in all areas.

To receive in-home service, product must be unobstructed and accessible to the service agent. If service is not available, SAMSUNG may elect to provide transportation of the product to and from an authorized service center.

SAMSUNG will repair, replace, or refund this product at our option and at no charge as stipulated herein, with new or reconditioned parts or products if found to be defective during the limited warranty period specified above. All replaced parts and products become the property of SAMSUNG and must be returned to SAMSUNG. Replacement parts and products assume the remaining original warranty, or ninety (90) days, whichever is longer. This limited warranty covers manufacturing defects in materials and workmanship encountered in normal, noncommercial use of this product and shall not apply to the following: damage that occurs in shipment; delivery and installation; applications and uses for which this product was not intended; altered product or serial numbers; cosmetic damage or exterior finish; accidents, abuse, neglect, fire, water, lightning, or other acts of nature or God; use of products, equipment, systems, utilities, services, parts, supplies, accessories, applications, installations, repairs, external wiring or connectors not supplied or authorized by SAMSUNG that damage this product or result in service problems; incorrect electrical line voltage, fluctuations and surges; customer adjustments and failure to follow operating instructions, maintenance and environmental instructions that are covered and prescribed in the instruction book; product removal and reinstallation; problems caused by pest infestations. This limited warranty does not cover problems resulting from incorrect electric current, voltage or supply, light bulbs, house fuses, house wiring, cost of a service call for instructions, or fixing installation errors. SAMSUNG does not warrant uninterrupted or error-free operation of the product.

warranty (CANADA)

EXCEPT AS SET FORTH HEREIN, THERE ARE NO WARRANTIES ON THIS PRODUCT EITHER EXPRESS OR IMPLIED, AND SAMSUNG DISCLAIMS ALL WARRANTIES INCLUDING, BUT NOT LIMITED TO, ANY IMPLIED WARRANTIES OF MERCHANTABILITY, INFRINGEMENT OR FITNESS FOR A PARTICULAR PURPOSE.

NO WARRANTY OR GUARANTEE GIVEN BY ANY PERSON, FIRM, OR CORPORATION WITH RESPECT TO THIS PRODUCT SHALL BE BINDING ON SAMSUNG. SAMSUNG SHALL NOT BE LIABLE FOR LOSS OF REVENUE OR PROFITS, FAILURE TO REALIZE SAVINGS OR OTHER BENEFITS, OR ANY OTHER SPECIAL, INCIDENTAL OR CONSEQUENTIAL DAMAGES CAUSED BY THE USE, MISUSE, OR INABILITY TO USE THIS PRODUCT, REGARDLESS OF THE LEGAL THEORY ON WHICH THE CLAIM IS BASED, AND EVEN IF SAMSUNG HAS BEEN ADVISED OF THE POSSIBILITY OF SUCH DAMAGES.

NOR SHALL RECOVERY OF ANY KIND AGAINST SAMSUNG BE GREATER IN AMOUNT THAN THE PURCHASE PRICE OF THE PRODUCT SOLD BY SAMSUNG AND CAUSING THE ALLEGED DAMAGE. WITHOUT LIMITING THE FOREGOING, PURCHASER ASSUMES ALL RISK AND LIABILITY FOR LOSS, DAMAGE, OR INJURY TO PURCHASER AND PURCHASER'S PROPERTY AND TO OTHERS AND THEIR PROPERTY ARISING OUT OF THE USE, MISUSE, OR INABILITY TO USE THIS PRODUCT. THIS LIMITED WARRANTY SHALL NOT EXTEND TO ANYONE OTHER THAN THE ORIGINAL PURCHASER OF THIS PRODUCT, IS NONTRANSFERABLE AND STATES YOUR EXCLUSIVE REMEDY.

Some provinces do not allow limitations on how long an implied warranty lasts, or the exclusion or limitation of incidental or consequential damages, so the above limitations or exclusions may not apply to you. This warranty gives you specific rights, and you may also have other rights, which vary from province to province.

To obtain warranty service, please contact SAMSUNG at:

Samsung Electronics Canada Inc.

2050 Derry Road West

Mississauga, Ontario L5N 0B9 Canada

1-800-SAMSUNG (726-7864)

www.samsung.com/ca/support (English)

www.samsung.com/ca_fr/support (French)

Visits by a Service Engineer to explain functions, maintenance or installation is not covered by warranty.

Please contact your Samsung call agent for help with any of these issues.

memo

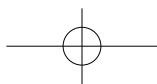
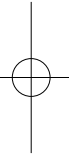
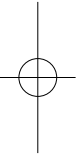
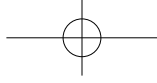



Scan the QR code* or visit
www.samsung.com/spsn
to view our helpful
How-to Videos and Live Shows

*Requires reader to be installed on your smartphone

Scan this with your smartphone

QUESTIONS OR COMMENTS?

Country	CALL	OR VISIT US ONLINE AT
U.S.A	1-800-SAMSUNG (726-7864)	www.samsung.com/us/support
CANADA	1-800-SAMSUNG (726-7864)	www.samsung.com/ca/support (English) www.samsung.com/ca_fr/support (French)
MEXICO	01-800-SAMSUNG (726-7864)	www.samsung.com/mx/support

Code No. DC68-03133Y_EN