

Operating and Installation Instructions Induction Cooktops



To prevent accidents and machine damage, read these instructions **before** installation or use.

Contents

IMPORTANT SAFETY INSTRUCTIONS	4
Caring for the environment	15
Overview	16
KM 6360, KM 6365	16
KM 6370, KM 6375	17
KM 6377	18
DirectSelection Plus controls	19
Cooking zone data	20
Before first use	23
Cleaning the cooktop for the first time.....	23
Turning on the cooktop for the first time	23
Induction	24
How it works.....	24
Cookware	24
Noises.....	26
Energy saving tips	27
Power setting ranges	28
Operation	29
Basic operation	29
Turning on.....	30
Selecting/changing the power level	30
Turning off.....	30
Residual heat indicator.....	30
Setting the power level – extended power level range.....	31
PowerFlex cooking area	31
Auto Heat-up	32
Booster	33
Keeping warm	35
Timer	36
Timer	36
Switching off a cooking zone automatically	38
Using both timer functions at the same time	39
Additional functions	40
Stop & Go function.....	40
Safety features	41
System lock / Safety lock.....	41

Safety shut-off	42
Overheat protection	43
Cleaning and care	44
Programming	46
Frequently Asked Questions	49
Con@ctivity	52
Customer Service	53
Contact in the event of a fault	53
Appliance warranty and product registration	53
Installation	54
IMPORTANT SAFETY INSTRUCTIONS - INSTALLATION	54
Safety distances	55
Installation notes	59
Proud installation	59
Flush installation	60
Ventilation	61
Installation dimensions – Proud	62
KM 6360	62
KM 6370	63
KM 6377	64
Proud installation	65
Installation dimensions – Flush	66
KM 6365	66
KM 6375	67
Flush installation	68
Electrical connection	70
MieleCare	72

IMPORTANT SAFETY INSTRUCTIONS

This cooktop complies with all relevant local and national safety requirements. Inappropriate use can, however, lead to personal injury and material damage.

Read the operating and installation instructions carefully before using the cooktop. They contain important information on safety, installation, use and maintenance. This prevents both personal injury and damage to the cooktop.

When installing the cooktop, Miele expressly and strongly advises that you read and follow the instructions under “Installation”, as well as in the “IMPORTANT SAFETY INSTRUCTIONS”.

Miele cannot be held liable for injury or damage caused by non-compliance with these instructions.

Keep these instructions in a safe place and pass them on to any future owner.

IMPORTANT SAFETY INSTRUCTIONS

Appropriate use

- ▶ This cooktop is intended for domestic use and use in other similar environments.
- ▶ This cooktop is not intended for outdoor use.
- ▶ The cooktop is intended for domestic use only to prepare food and keep it warm. Any other use may be dangerous.
- ▶ Persons (including children) who lack physical, sensory or mental abilities, or experience with the appliance should not use it without supervision or instruction by a responsible person.

IMPORTANT SAFETY INSTRUCTIONS

Safety with children

- ▶ As with any other appliance, children must be supervised.
- ▶ Do not leave children unattended: Children should not be alone or unsupervised in the area where the appliance is installed. Do not allow them to sit or stand on the appliance.
- ▶ Be sure to supervise any children in the vicinity of the cooktop, and do not let them play with it.
- ▶ The cooktop gets hot when in use and remains hot for some time after being turned off. Keep children away from the appliance until it has cooled down and is no longer a burn hazard.
- ▶ Danger of burning. Do not store anything which might arouse a child's interest in storage areas above or behind the cooktop. Otherwise they could be tempted to climb onto the appliance.
- ▶ Risk of burning or scalding. Turn pot and pan handles inward, so children cannot pull them down and be burned.
- ▶ Danger of suffocation. While playing, children may become entangled in packaging material (such as plastic wrapping) or pull it over their head, presenting the risk of suffocation. Keep packaging material away from children.
- ▶ Activate the system lock to ensure that children cannot turn on the appliance inadvertently. Use the safety lock when the hob is in use to prevent children from altering the settings selected.

IMPORTANT SAFETY INSTRUCTIONS

Technical safety

- ▶ Unauthorized installation, maintenance, and repairs can cause considerable danger for the user. Installation, maintenance, and repairs must only be carried out by a Miele authorized technician.
- ▶ Maintenance by the user: Never repair or replace any part of the appliance unless the instructions specifically recommend doing so. Service work should only be performed by a qualified technician.
- ▶ Damage to the cooktop can compromise your safety. Check the cooktop for visible signs of damage. Do not use the cooktop if it is damaged.
- ▶ Reliable and safe operation of the cooktop can only be guaranteed if it is connected to the public power supply.
- ▶ The cooktop must not be connected to the inverter of an autonomous power supply, e.g., **a solar power system**. When the cooktop is switched on, power surges could result in a safety shut-off. This could damage the electronic.
- ▶ Be certain your appliance is properly installed and grounded by a qualified technician. To guarantee the electrical safety of this appliance, continuity must exist between the appliance and an effective grounding system. It is imperative that this basic safety requirement be met. If there is any doubt, have the electrical system of the house checked by a qualified electrician.
- ▶ Proper installation: Make sure that your appliance has been installed correctly and that it has been grounded by a qualified technician.
- ▶ To avoid damaging the cooktop, make sure that the connection data (voltage and frequency) on the data plate correspond to the building's power supply before connecting the appliance. When in doubt, consult a qualified electrician.

IMPORTANT SAFETY INSTRUCTIONS

- ▶ Do not connect the appliance to the electrical supply with a power bar or extension cord. These are a fire hazard and do not guarantee the required safety of the appliance.
- ▶ For safety reasons, the cooktop may only be used when it has been fully installed.
- ▶ This appliance must not be used in a non-stationary location (e.g. on a ship).
- ▶ Any contact with live connections or tampering with the electrical or mechanical components of the cooktop will endanger your safety and may lead to appliance malfunctions.
Do not open the casing of the cooktop under any circumstances.
- ▶ Any repairs not performed by a Miele authorized service technician will void the warranty.
- ▶ Defective components should be replaced by Miele original parts only. Only with these parts can safety of the appliance be assured as intended by the manufacturer.
- ▶ The appliance is not intended for use with an external timer switch or a remote control system.
- ▶ The cooktop must be connected to the electricity supply by a qualified electrician (see “Installation – Electrical connection”).
- ▶ If the power cord is damaged, it must only be replaced by a qualified service technician (see “Installation – Electrical connection”).

IMPORTANT SAFETY INSTRUCTIONS

- ▶ The appliance must be completely disconnected from the electricity supply during installation, maintenance and repair work. Ensure that power is not supplied to the appliance until after it has been installed or until any maintenance or repair work has been carried out. Disconnect by
 - removing the fuse,
 - “tripping” the circuit breaker, or
 - unplugging the unit (if equipped with plug). Pull the plug not the cord.
- ▶ If the cooktop is fitted with a communication module, in addition to disconnecting the cooktop, this module must also be disconnected from the electrical supply during installation and maintenance of the cooktop as well as while any repair work is being carried out.
- ▶ Danger of electric shock. Do not use the cooktop if it is faulty, or if the ceramic surface is cracked, chipped, or damaged in any way. Switch it off immediately. Disconnect the cooktop from the electrical power supply. Contact Miele Service.
- ▶ If the cooktop is installed behind a cabinet door, do not close the door while the cooktop is in operation. Heat and moisture can build up behind the closed door and cause damage to the cooktop, cabinetry, and flooring. Do not close the door until the residual heat indicators go out.
- ▶ Do not open the cooktop housing under any circumstances.
- ▶ Disconnect the cooktop from the electrical power supply before carrying out any maintenance or repair work.

IMPORTANT SAFETY INSTRUCTIONS

Correct use

- ▶ The cooktop gets hot when in use and remains hot for a while after being turned off. There is a potential hazard until the residual heat indicator goes out.
- ▶ Do not leave the cooktop unattended when cooking on high power. Spilled food will begin to smoke and cause grease splatter, which can ignite on the cooktop. Doing so may result in carbon monoxide poisoning and overheating of the appliance.
- ▶ Oil and fat can catch fire if overheated. Never leave the appliance unattended when cooking with oil and fat. If the oil or fat catches fire, do not attempt to put the flames out with water. Turn off the cooktop and smother the flames using a lid or a suitable fire blanket.
- ▶ Smother the fire or flames, or use a dry chemical extinguishing agent or foam fire extinguisher.
- ▶ Storage in or on the appliance: Flammable materials should not be stored in an oven or in the vicinity of the cooktop.
- ▶ The flames could set the grease filters of a ventilation hood on fire. Do not flambé under a ventilation hood.
- ▶ Spray canisters, aerosols and other inflammable substances can ignite when heated. Therefore do not store such items or substances in a drawer under the appliance. Cutlery inserts must be heat-resistant.
- ▶ Never heat empty cookware.
- ▶ Do not heat or can food in closed containers, such as tins or sealed jars, on the cooktop, as pressure will build up in the container and cause it to explode.

IMPORTANT SAFETY INSTRUCTIONS

- ▶ If the cooktop is covered, there is a risk that the material of the cover will ignite, explode or melt if the cooktop is still hot or if turned on inadvertently. Never cover the cooktop with a board, cloth or protective sheet.
- ▶ If the cooktop is turned on or accidentally turned on or if it is still hot, metal objects on the cooktop can heat up. Other items may melt or catch fire. Damp lids can become attached to the cooktop by suction. Do not store items on the cooktop! Always turn the cooking zones off after use!
- ▶ You could burn yourself on the hot cooktop. Protect your hands with heat-resistant pot holders or gloves when handling hot pots and pans. Do not let them get wet or damp, as this causes heat to transfer through the material more quickly with the risk of scalding or burning yourself.
- ▶ When using an electrical appliance, e.g. a hand mixer, near the cooktop, make sure that the power cable does not come into contact with the hot cooktop. The cable's insulation could become damaged.
- ▶ Grains of salt, sugar and sand (e.g. from cleaning vegetables) can cause scratches if they get under pan bases. Make sure that the ceramic surface is clean before placing pans on it.
- ▶ Even a light object can cause damage to the ceramic cooktop in certain circumstances. Do not drop anything on the ceramic surface.
- ▶ Do not place hot pans on the sensor buttons and display as this could cause damage to the electronics underneath. Do not place hot pans on the area around the display.

IMPORTANT SAFETY INSTRUCTIONS

- ▶ Do not allow solid or liquid sugar, or pieces of plastic or aluminum foil to get onto the cooktop when it is hot, as they can damage the ceramic surface when it cools down. If this should occur, turn off the appliance immediately and scrape off all the sugar, plastic or aluminum residues while still hot, using a shielded scraper blade. Use pot holders. Allow the ceramic surface to cool down before cleaning with a suitable ceramic cleaning agent.
- ▶ Pans that boil dry can cause damage to the ceramic glass. Do not leave the appliance unattended while it is being used.
- ▶ Pots and pans with bases with pronounced edges or ridges can scratch the ceramic surface. Only use pots and pans with smooth bases.
- ▶ Lift pans into position on the cooktop. Sliding them into place can cause scuffs and scratches.
- ▶ Fire hazard! Loose-fitting or hanging garments can catch fire. Be sure to wear appropriately fitting clothing when cooking. Never allow loose clothing or flammable materials to come into contact with the cooking zones while the cooking zones are in use.
- ▶ Because induction heating works so quickly, the temperature can quickly reach the ignition point of oils and fats. Never leave the cooktop unattended when it is turned on.
- ▶ Do not heat oils and fats for longer than 1 minute, and never use the booster.
- ▶ For people who have a heart pacemaker: Please note that the area immediately surrounding the cooktop is electromagnetically charged. It is very unlikely to affect a pacemaker. However, if in any doubt, consult the manufacturer of the pacemaker or your doctor.
- ▶ Objects affected by electromagnetic fields, for instance credit cards, CDs and calculators, should be kept away from the cooktop when it is on.

IMPORTANT SAFETY INSTRUCTIONS

- ▶ Metal utensils stored in a drawer under the cooktop can become hot if the appliance is used intensively for a long time.
- ▶ The cooktop is equipped with a cooling fan. If a drawer is located directly underneath the cooktop, ensure that there is sufficient space between the drawer and its contents and the underside of the cooktop in order to ensure sufficient ventilation for the cooktop.
- ▶ If a drawer is located directly underneath the cooktop, do not store any pointed or small items, paper, napkins, etc. in the drawer. They could get in through the ventilation slots or be sucked into the casing by the fan and damage the fan or impair cooling.
- ▶ Never use two pieces of cookware on a standard cooking zone, extended zone, or PowerFlex area at the same time.
- ▶ If the cookware only partially covers a cooking zone, the handle could become very hot.
Always place cookware in the middle of the cooking zone.
- ▶ Wet sponges or clothes can cause burns due to hot steam if they are used to wipe spilled food off a hot cooktop. Some cleansers can emit hazardous vapors if they are applied to a hot surface. Be careful when cleaning the cooktop.
- ▶ If the cooktop is damaged, cleansers or spilled food can penetrate the glass surface and cause a short-circuit. Never cook on a damaged cooktop. Contact an electrician immediately.
- ▶ If an induction adapter plate is used for cookware, the induction generators may be damaged or even destroyed. Do not use induction adapter plates.

IMPORTANT SAFETY INSTRUCTIONS

Cleaning and maintenance

- ▶ Do not use a steam cleaner to clean the cooktop. The steam may reach electrical components and cause a short circuit.
- ▶ If the cooktop is built in over a self cleaning oven, the cooktop should not be used while the self cleaning process is being carried out, as this could trigger the overheating protection mechanism on the cooktop (see relevant section).
- ▶ Miele will guarantee to supply functional parts for a minimum of 10 years and up to 15 years following the discontinuation of your cooktop.

Disposal of the packing material

The cardboard box and packing materials protect the appliance during shipping. They have been designed to be biodegradable and recyclable.

Ensure that any plastic wrappings, bags, etc. are disposed of safely and kept out of the reach of children. Danger of suffocation!

Disposal of your old appliance

Electrical and electronic appliances contain valuable materials. They also contain certain substances, compounds and components which were essential for the proper functioning and safe use of the equipment. Handling these materials improperly by disposing of them in your household waste can be harmful to your health and the environment. Therefore, please do not dispose of your old appliance with regular household waste and follow local regulations on proper disposal.



Consult with local authorities, dealers or Miele in order to dispose of and recycle electrical and electronic appliances. Miele assumes no responsibility for deleting any personal data left on the appliance being disposed. Please ensure that your old appliance is kept away from children until removal. Observe safety requirements for appliances that may tip over or pose an entrapment hazard.

Overview

KM 6360, KM 6365

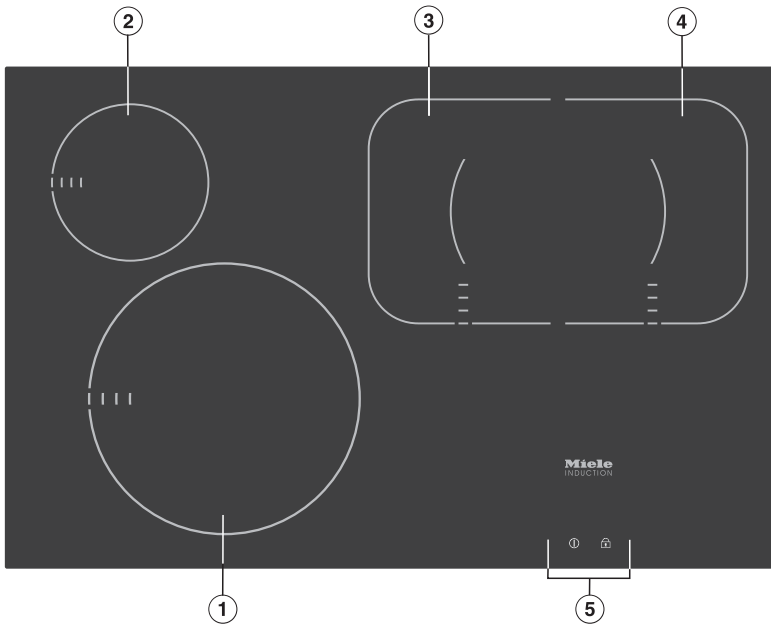

- ① Cooking zone with TwinBooster
- ② Cooking zone with Booster
- ③ PowerFlex cooking zone with TwinBooster
- ④ PowerFlex cooking zone with TwinBooster
- ③④ can be combined to form PowerFlex cooking area
- ⑤ DirectSelection Plus controls

KM 6370, KM 6375

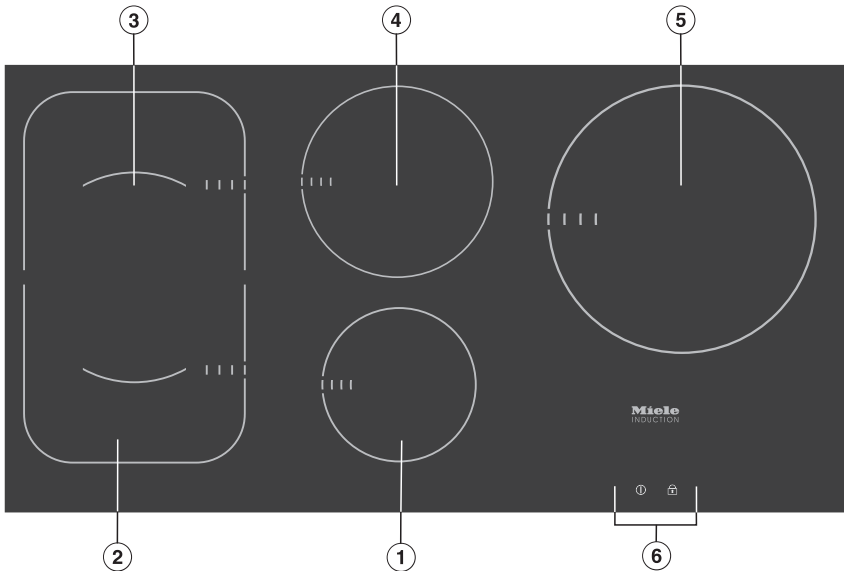

- ① Cooking zone with Booster
- ② PowerFlex cooking zone with TwinBooster
- ③ PowerFlex cooking zone with TwinBooster
- ②③ can be combined to form PowerFlex cooking area
- ④ Cooking zone with Booster
- ⑤ Cooking zone with TwinBooster
- ⑥ DirectSelection Plus controls

Overview

KM 6377

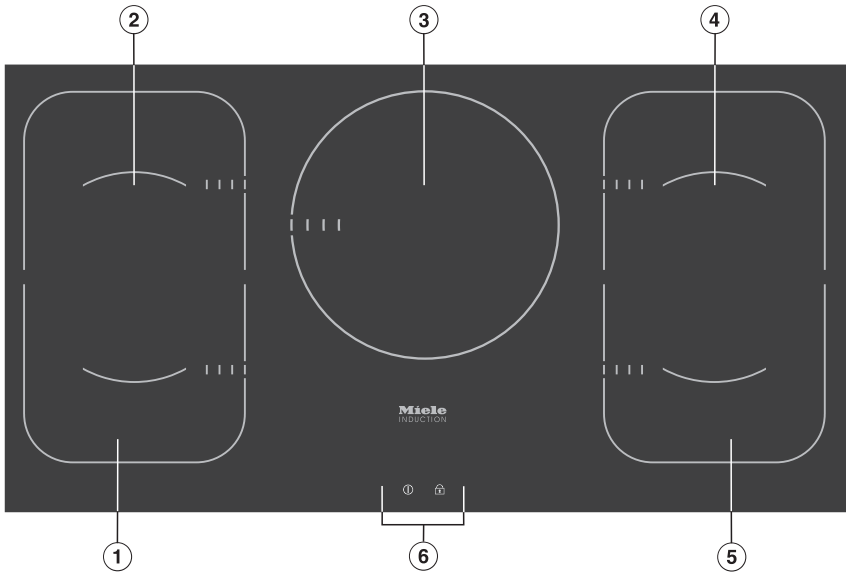

- ① PowerFlex cooking zone with TwinBooster
- ② PowerFlex cooking zone with TwinBooster
- ①② can be combined to form PowerFlex cooking area
- ③ Cooking zone with TwinBooster
- ④ PowerFlex cooking zone with TwinBooster
- ⑤ PowerFlex cooking zone with TwinBooster
- ④⑤ can be combined to form PowerFlex cooking area
- ⑥ DirectSelection Plus controls

DirectSelection Plus controls

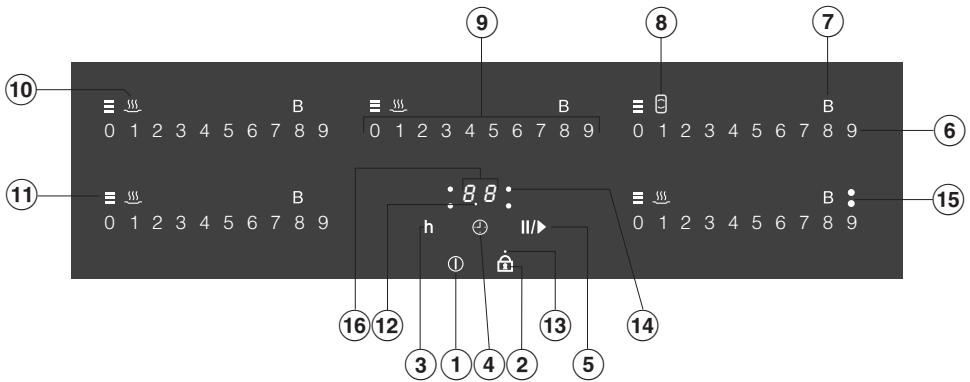

Sensor buttons

- ① Turning the cooktop On/Off
- ② Activating and deactivating the System lock/Safety lock
- ③ Switching the timer to hours
- ④ Timer
 - For turning on and off
 - For switching between timer functions
 - For selecting a cooking zone (see “Switching off a cooking zone automatically”)
- ⑤ Activating/deactivating the Stop & Go function
- ⑥ For selecting the power setting
- ⑦ For switching the Booster/TwinBooster On/Off
- ⑧ Turning the PowerFlex cooking area On/Off
- ⑨ Control scale
 - For setting a timer / turn-off after duration
 - For setting the power level for middle rear cooking zone (depending on model)
- ⑩ Turning the keep warm function On/Off

Indicators

- ⑪ Residual heat
- ⑫ For half hours if the timer setting is over 99 minutes
- ⑬ System lock/Safety lock activated
- ⑭ For cooking zone selection, e.g., right rear cooking zone

Overview





⑮ TwinBooster activated

- Level 1
- Level 2

⑯ Timer display







- 00 to 99* Time in minutes
0.h to 9.h Time in hours
LL System lock/Safety lock activated
dE Demo mode activated

Cooking zone data

KM 6360, KM 6365					
Cooking zone	Diameter* Ø		Output in watt**		
	Inches	Centimeters		208 V	240 V
	7-11	18-28	Normal TwinBooster, Level 1 TwinBooster, Level 2	2200 2700 3350	2500 3100 3850
	4-6	10-16	Normal Booster	1250 1700	1450 1900
	6-9	15-23	Normal TwinBooster, Level 1 TwinBooster, Level 2	1900 2700 3350	2200 3100 3850
	6-9	15-23	Normal TwinBooster, Level 1 TwinBooster, Level 2	1900 2700 3350	2200 3100 3850
	8 ¹ / ₂ -9 / 6x9-9x15	22-23 / 15 x 23 – 23 x 39	Normal TwinBooster, Level 1 TwinBooster, Level 2	3050 4300 6700	3550 5000 7700
			Max. Possible Output	6700	7700

* Cookware of any diameter may be used within the specified range.







** The wattage quoted may vary depending on the size and material of the pans used.

KM 6370, KM 6375					
Cooking zone	Diameter* Ø		Output in watt**		
	Inches	Centimeters		208 V	240 V
	6–9	15–23	Normal TwinBooster, Level 1 TwinBooster, Level 2	1900 2700 3350	2200 3100 3850
	6–9	15–23	Normal TwinBooster, Level 1 TwinBooster, Level 2	1900 2700 3350	2200 3100 3850
	5 ¹ / ₂ –8	14–20	Normal Booster	1700 2250	1950 2600
	7–11	18–28	Normal TwinBooster, Level 1 TwinBooster, Level 2	2200 2700 3350	2500 3100 3850
	4–6	10–16	Normal Booster	1250 1700	1450 1900
	8 ¹ / ₂ –9 / 6x9–9x15	22–23 / 15 x 23 – 23 x 39	Normal TwinBooster, Level 1 TwinBooster, Level 2	3050 4300 6700	3550 5000 7700
			Max. Possible Output	10000	11500

* Cookware of any diameter may be used within the specified range.

** The wattage quoted may vary depending on the size and material of the pans used.

Overview

KM 6377					
Cooking zone	Diameter* Ø		Output in watt**		
	Inches	Centimeters		208 V	240 V
	6–9	15–23	Normal TwinBooster, Level 1 TwinBooster, Level 2	1900 2700 3350	2200 3100 3850
	6–9	15–23	Normal TwinBooster, Level 1 TwinBooster, Level 2	1900 2700 3350	2200 3100 3850
	7–11	18–28	Normal TwinBooster, Level 1 TwinBooster, Level 2	2200 2700 3350	2500 3100 3850
	6–9	15–23	Normal TwinBooster, Level 1 TwinBooster, Level 2	1900 2700 3350	2200 3100 3850
	6–9	15–23	Normal TwinBooster, Level 1 TwinBooster, Level 2	1900 2700 3350	2200 3100 3850
	8 ¹ / ₂ –9 / 6x9–9x15	22–23 / 15 x 23 – 23 x 39	Normal Booster	3050 3350	3550 3850
	8 ¹ / ₂ –9 / 6x9–9x15	22–23 / 15 x 23 – 23 x 39	Normal TwinBooster, Level 1 TwinBooster, Level 2	3050 4300 6700	3550 5000 7700
			Max. Possible Output	10000	11500

* Cookware of any diameter may be used within the specified range.

** The wattage quoted may vary depending on the size and material of the pans used.

Cleaning the cooktop for the first time

- Before first use, wipe down the appliance with a damp cloth and dry it.

Turning on the cooktop for the first time

Metal components are protected by a conditioning agent. Smells and vapor may occur when the appliance is used for the first time. The heating of the induction coils also causes odors in the first few hours of operation. With each subsequent use, the odor is reduced until it disappears entirely.

The smell and any vapors do not indicate a faulty connection or a defective appliance and are not harmful to your health.

Please note that the heat-up time for induction cooktops is very much shorter than for conventional cooktops.

Induction

How it works

An induction coil is located under each cooking zone. The coil creates a magnetic field that reacts directly with the base of the pan and heats it up. The cooking zone itself is heated up indirectly by the heat given off by the pan.

An induction cooking zone only works when a piece of cookware with a magnetic base is placed on it (see “Cookware”). The induction cooking zone automatically recognizes the size of the cookware.



Risk of burning due to hot items. When the cooktop is switched on either deliberately or by mistake, or when there is residual heat present, there is the risk of metal items placed on the cooktop heating up. Do not store items on the cooktop. After use, switch the cooktop off with the  sensor control.

Cookware

Suitable cookware

- Stainless steel with a magnetic base
- Enameled steel
- Cast iron

The composition of the pan bottom can affect the evenness of the cooking results (e.g., when making pancakes). The base of the pan must be able to distribute the heat evenly. A sandwich base made of stainless steel is particularly suitable.

Unsuitable cookware

- Stainless steel without a magnetic base
- Aluminum or copper
- Glass, ceramics, earthenware, stoneware

Testing cookware

To test whether a pot or pan is suitable for use on an induction cooktop, hold a magnet to the base of the pan. If the magnet sticks, the cookware is generally suitable.

No cookware/unsuitable cookware display

The set power level flashes in the numerical keybank for the cooking zone if

- no cookware or unsuitable cookware (items without a magnetizable bottom) is being used
- the bottom diameter of the cookware being used is too small
- the cookware is removed from a cooking zone that is on

If suitable cookware is placed on the cooking zone within 3 minutes, the flashing power level will go out and you can continue as usual.

If no cookware or if unsuitable cookware is used, the cooking zone will automatically turn off after 3 minutes.

Tips

- To make optimum use of the cooking zones, choose cookware with a suitable base diameter (see “Overview“, “Cooking zone data”). If the cookware is too small it will not be recognized.
- Position the cookware as centrally as possible on the relevant cooking zone/cooking area.
- Use only pots and pans with smooth bases. Rough bases can scratch the ceramic glass.
- Always lift the cookware to move it. This will help prevent scratching. If any scratches do appear as a result of cookware being pushed around, this will not affect the function of the cooktop. These scratches are normal signs of use.
- Please note that the maximum diameter quoted by manufacturers often refers to the diameter of the top rim of the pot or pan. The diameter of the base (generally smaller) is more important.

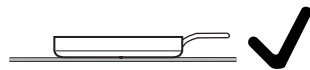

- If possible, use pans with straight sides. If pans with sloped sides are used, the induction also takes effect around the edges of the pan. This can cause the edge of the pan to become discolored or the coating to peel off.

Induction

Noises

When you use an induction cooking zone, the following noises may occur, depending on the type and shape of the cookware bottom:

On the higher power levels, it might buzz. This will decrease or cease altogether when the power level is reduced.

Cookware with bottoms made of different materials (e.g., sandwich bottoms) may produce a crackling noise.

Whistling may occur if connected cooking zones (see “Operation – Booster”) are simultaneously in use and cookware with bottoms made of different materials (e.g., sandwich bottoms) is placed on them.

The electronics may produce a clicking sound, especially at lower power levels.

You may hear a whirring sound when the cooling fan turns on. It turns on to protect the electronics when the cooktop is being used intensively. The fan may continue to run after the appliance has been turned off.

- Use a lid whenever possible to minimize heat loss.
- For small quantities, select a small pan. A small pan on a small cooking zone uses less energy than a large, only partially filled pan on a large cooking zone.
- Cook with as little water as possible.
- Once food has come to the boil or the pan is hot for frying, reduce the heat to a lower power setting.

Power setting ranges





The cooktop is programmed with 9 power levels at the factory. If you wish to fine-tune a setting, you can extend the power setting range to 17 power levels (see “Programming”).

	Setting ranges	
	Default (9 power levels)	Extended (17 power levels)
Melting butter Dissolving gelatin Melting chocolate	1–2	1–2.
Making pudding	2	2–2.
Warming small quantities of liquid Cooking rice	3	3–3.
Thawing frozen vegetables (blocks)	3	2.–3
Making oatmeal	3	2.–3.
Warming liquid and half-set foods Making omelettes or lightly fried eggs Steaming fruit	4	4–4.
Cooking dumplings	4	4–5.
Steaming vegetables or fish	5	5
Thawing and heating frozen food	5	5–5.
Gently frying eggs (without overheating the fat)	6	5.–6.
Bringing large quantities of food to a boil, e.g., casseroles. Thickening custard and sauces, e.g., hollandaise.	6–7	6.–7
Gently frying meat, fish or sausages (without overheating the fat)	6–7	6.–7.
Frying pancakes, etc.	7	6.–7
Braising for stews	8	8–8.
Boiling large quantities of water Bringing to a boil	9	9

These settings should only be taken as a guide. The power of the induction coils will vary depending on the size and material of the pan. For this reason, it is possible that the settings will need to be adjusted slightly to suit your pans. As you use the cooktop, you will get to know which settings suit your pans best. For new cookware whose properties for use you are not yet familiar with, set the next lowest power level than the one specified.

Basic operation

The glass ceramic cooking zone is equipped with electronic sensor buttons that react to finger contact. During activation, the On/Off  sensor button must be pressed somewhat longer than the other buttons for safety reasons. Each reaction of the buttons is acknowledged with an acoustic signal.

When the cooktop is turned off, only the pressed symbols for the On/Off  and System Lock/Safety Lock  sensor buttons are visible. When you switch on the cooktop, all other sensor buttons light up. When you turn on the cooking zone, the  sensor button lights up in brightness level 2, and the  through  sensor buttons light up in brightness level 1.

When you set a power level, the  sensor buttons light up to the set power stage in brightness level 2.

If the booster or keep warm function is set, the corresponding sensor button lights up in brightness level 2.

 Malfunction can occur due to dirty and/or covered sensor controls. If the sensor controls are dirty or covered this could cause them to fail to react, to activate a function, or even to switch the cooktop off automatically (see “Safety features – Safety shut-off”). Placing hot cookware on the sensor controls/indicators can damage the electronic underneath.

Keep the sensor controls and indicators clean.

Do not place anything over the sensor controls or indicators.

Do not place hot cookware over the sensor controls or indicators.

Operation

 Fire hazard due to overheated food.
Unattended food can overheat and ignite.
Do not leave the cooktop unattended whilst it is being used.

Please note that the heating-up time on induction cooktops is much shorter than on conventional cooktops.

Turning on

- To turn on the cooktop, briefly touch the  sensor button.



All of the sensor buttons will light up. If no further entry is made, the cooktop will turn itself off after a few seconds for safety reasons.

- To turn on a cooking zone, tap the  sensor button on the corresponding control scale.

Selecting/changing the power level

- Tap the sensor button for the desired power level on the corresponding control scale.

Turning off

- To turn off a cooking zone, tap the  sensor button on the corresponding control scale.
- To turn off the cooktop and thus all cooking zones, tap the  sensor button.

Residual heat indicator

When a cooking zone is hot, the residual heat indicator and the  sensor button light up on the control scale after deactivation.

The lines of the residual heat indicator go out one after another as the cooking zones cool down. The last bar and the  sensor button go out together.

The residual heat indicators will flash if there is a power cut during use or while residual heat is still present or if you have opened the programming function while residual heat is still present.

 Risk of burning or scalding due to hot cooking zones.

The cooking zones will be hot after use.

Do not touch the cooking zones while the residual heat indicators are on.

Setting the power level – extended power level range

- Touch the numerical keybank between two number sensors.

The numbers to the left and right of the interim level light up brighter than the other sensor controls.



Example:

If you have set power level 7., the numbers 7 and 8 will be brighter than the other numbers.

PowerFlex cooking area

You can combine the PowerFlex cooking zones into one large PowerFlex cooking area (see the “Overview – Cooking zone data” chapter). The settings for the cooking zone are controlled using the front or left PowerFlex cooking zone.

Activating

- On the control scale, use the  symbol to tap the  sensor button.
- Tap the  sensor button.
- Set the power level on the control scale of the front or left cooking zone.

Deactivating

- Tap the  sensor button.

Operation

Auto Heat-up

When Auto Heat-up has been activated, the cooking zone turns on automatically at the highest level and then switches to the previously selected continued cooking level. The heat-up time depends on which continued cooking level has been chosen (see chart).

Activating

- Tap the sensor button of the required continued cooking level until an audible tone sounds and the sensor button starts to flash.

During the heat-up time, the set continued cooking level flashes.

With extended power levels (see “Programming”), the power levels before and after the intermediate power level will flash when an intermediate power level is selected.

When you change the continued cooking level, you deactivate Auto Heat-up.

Deactivating

- Tap the sensor button of the set continued cooking level.

or

- select a different power level.

Continued cooking level*	Heat-up time [min:sec]
1	approx. 0:15
1.	approx. 0:15
2	approx. 0:15
2.	approx. 0:15
3	approx. 0:25
3.	approx. 0:25
4	approx. 0:50
4.	approx. 0:50
5	approx. 2:00
5.	approx. 5:50
6	approx. 5:50
6.	approx. 2:50
7	approx. 2:50
7.	approx. 2:50
8	approx. 2:50
8.	approx. 2:50
9	–

* The continued cooking settings with a dot after the number are only available if the power level range has been extended (see “Programming”).

Booster

The cooking zones are equipped with a Booster or TwinBooster function (see “Overview – Cooktop”).

When the Booster function is activated, the power is boosted so that large quantities can be heated up quickly, e.g., when boiling water for cooking pasta. The boost in power is active for a maximum of 15 minutes.

The Booster function can only be used on two cooking zones at the same time.

If the Booster function is turned on when

- no power level has been selected, the cooking zone will revert automatically to level 9 at the end of the Booster time or if the Booster function is turned off before this.
- a power level has been selected, the cooking zone will revert automatically to the setting selected at the end of the Booster time or if the Booster function is turned off before this.

The cooking zones are connected in pairs in order to provide sufficient power for the Booster. While the Booster function is in operation, some of the power is taken away from the linked cooking zone. This has one of the following effects:

- Auto heat-up is deactivated.
- The power level is reduced.
- The linked cooking zone is switched off.

Operation

During the booster time, the *B* sensor button and all of the sensor buttons on the control scale are at brightness level 2.

Activating the booster

- Tap the *B* sensor button on the control scale for the desired cooking zone.
- Select a power level if required.
- Tap the *B* sensor button.

TwinBooster level 1 activation

- Tap the *B* sensor button on the control scale for the desired cooking zone.
- Select a power level if required.
- Tap the *B* sensor button.

The ● indicator light for TwinBooster level 1 comes on.

TwinBooster level 2 activation

- Tap the *B* sensor button on the control scale for the desired cooking zone.
- Select a power level if required.
- Tap the *B* sensor button twice.

The ● indicator light for TwinBooster level 2 comes on.

Turning the booster/TwinBooster On/Off

- Tap the *B* sensor button:
 - once (booster)
 - until the indicator lights go off (Twin-Booster)
- or
- select a different power level.

Keeping warm

This function is for keeping food warm which has just been cooked and is still hot. It is not for reheating food that has gone cold.

The maximum duration for keeping food warm is 2 hours.

- Only use cookware (pots/pans) for keeping food warm. Cover the cookware with a lid.
- Stir firm or viscous food (mashed potatoes, stew) occasionally.
- Foods begin to lose their nutrients during the cooking process and continue to do so while being kept warm. The longer food is kept warm, the greater the loss of nutrients. Try to ensure that food is kept warm for as short a time as possible.

Turning the keep warm function On/Off

- Tap the  sensor button for the desired cooking zone.

Timer

The cooktop has to be turned on if you wish to use the timer. You can set a time between 1 minute (01) and 9 hours (9.h).

The timer can be used for two different functions:

- For setting the timer
- For turning off a cooking zone automatically.

A time up to 99 minutes is set and displayed in minutes.

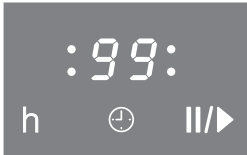

In case of a time of more than 99 minutes, the timer must be switched to hours (h). The time is set in half-hour steps. Half-hours are indicated by a dot following the number, for example, 2 h 30 min:

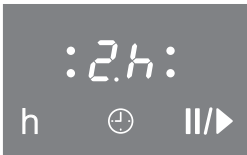

Timer

Setting the minutes

Example: You want to set a time of 15 minutes.

- Turn the cooktop on.
- Tap the ⊕ sensor button.

The ⊕ sensor button flashes. 00 appears in the timer display, and the right 0 flashes.

First the tens digit is set then the units digit.

- Tap the sensor button on the control scale that corresponds to the tens position (1 in this case).

The timer display will change and 1 will start flashing on the right.

- Tap the sensor button on the control scale that corresponds to the ones position (5 in this case).

The timer display will change. 1 jumps to the left and 5 appears on the right.



After several seconds, the ⊕ sensor button and timer display light up constantly. The timer starts to count down.

Setting the hours

To set full hours, tap the respective sensor button on the control scale. To set the half hours, tap the space between 2 sensor buttons on the control scale.

Example: You want to set a time of 2 hours and 30 minutes.

- Turn the cooktop on.
- Tap the  sensor button.

The  sensor button flashes.  appears in the timer display, and the right  flashes.



- Tap the *h* sensor button to switch the display to hours.
- Tap the control scale between the *2* and *3* sensor buttons.

After several seconds, the  sensor button and timer display light up constantly. The timer starts to count down.

Changing the timer

- Tap the  sensor button.
- Set a new time, as described above.

Deleting the timer

- Tap the  sensor button.
- On the control scale, tap the  sensor button.

Timer

Switching off a cooking zone automatically

You can set a time after which the cooking zone will switch off automatically. This function can be used on all cooking zones at the same time.

If the programmed time is longer than the maximum time allowed, the safety shut-off function will turn off the cooking zone automatically when the maximum time has elapsed (see “Safety shut-off”).

- Select a power level for the cooking zone you require.
- Keep touching the  sensor control until the indicator light for this cooking zone starts flashing.

If several cooking zones are on, the indicator lights flash in a clockwise direction, starting with the front left.

- Set the required time.

- If you want to set another cooking zone to switch off automatically, follow the same steps as described above.



If more than one switch-off time is programmed, the shortest time left will be displayed, and the corresponding indicator light will flash. The other indicator lights will light up constantly.

- If you want to show the time left for another cooking zone which is counting down in the background, touch the  sensor control repeatedly until the indicator light for the cooking zone you require flashes.

Using both timer functions at the same time

The minute minder and automatic switch-off functions can be used at the same time.

If you have programmed one or more switch-off times, and would like to use the minute minder as well:

- Touch the  sensor control repeatedly until the indicator lights of the programmed cooking zones light up constantly and  appears in the timer display.
- Set the time as described above.

If you have set the minute minder and would like to program one or more switch-off times as well:

- Touch the  sensor control repeatedly until the indicator light for the cooking zone you require flashes.
- Set the time as described above.

Shortly after the last entry, the timer display switches to the function with the shortest time left.

If you want to show the times left which are counting down in the background:

- Touch the  sensor control repeatedly until
 - the indicator light for the required cooking zone flashes (automatic switch-off).
 - the timer display (minute minder) starts flashing.

Starting with the shortest time left which is shown in the display, all switched-on cooking zones and the minute minder are shown in a clockwise direction.

Additional functions

Stop & Go function

When activated, the Stop & Go reduces the power of all cooking zones in use to power level 1.

The power levels of the zones and setting of the timer cannot be changed and the cooktop can only be turned off. A set timer and booster time continue to run. The Auto Heat-up time and set times for automatic turn-off are stopped.

When Stop & Go is deactivated, the cooking zones will run on the power level that was previously selected and the Auto Heat-up time and automatic turn-off times start to run again.

If the Stop & Go function is not deactivated, the cooktop turns off automatically after 1 hour.

Activation / deactivation

- Tap the **II/▶** sensor button.

Use this function to clean the controls quickly or if there is a danger over boiling over.

System lock / Safety lock

The system lock and safety lock are deactivated if there is a power outage.

Three-finger control is the default setting. You can change the default to one-finger control (see “Programming”).

Your cooktop is equipped with a safety lock to prevent the cooktop and the cooking zones being turned on or any settings being altered.



The **system lock** is activated when the cooktop is turned off. When it is activated, the cooktop cannot be turned on and the timer cannot be used. The cooktop is programmed so that the system lock must be activated manually. It can be programmed to be activated automatically 5 minutes after the cooktop has been turned off if the system lock is not manually activated first (see “Programming”).

The **safety lock** is activated when the cooktop is turned on. When the safety lock is activated, the cooktop can be operated only under certain conditions:

- The power levels for the cooking zones and the timer settings cannot be changed.
- The cooking zones, entire cooktop, and the timer can be turned off, but once turned off cannot be turned on again.



If a locked sensor switch is touched when the safety lock or the system lock is activated, the indicator light comes on and *LL* appears in the timer display for a few seconds.

Activating

- Tap the  and  sensor buttons of both right cooking zones until *LL* the indicator light of the safety lock appears in the timer display.

The indicator light and *LL* go out after a short while.

Deactivating

- Tap the  and  sensor buttons of both right cooking zones until *LL* the indicator light of the safety lock go out in the timer display.

Safety features

Safety shut-off

Excessive operating time

The safety shut-off mechanism is triggered automatically if a cooking zone is heated for an unusually long period of time. This time depends on the power level selected. If the time has been exceeded, the cooking zone turns off and the residual-heat indicator appears. If you turn the cooking zone off and on again, it will be ready for operation again.

Safety shut-off if the sensors are covered

Your cooktop will turn off automatically if one or several of the sensors remain covered for longer than 10 seconds, for example, by finger contact, food boiling over or by an object such as an oven glove or tea towel. *F* flashes in the timer display and a buzzer sounds every 30 seconds for 10 minutes.

When you remove the objects or soiling, *F* goes out, the buzzer goes off, and the cooktop is ready for operation again.

Overheat protection

All the induction coils and the cooling elements for the electronics are equipped with an overheating protection mechanism. To prevent the induction coils and cooling elements from overheating, the overheating protection mechanism works on the affected cooking zone or on the entire cooktop in the following ways:

Inductive coils

- Any booster function in operation will be turned off.
- The power level that is set will be reduced.
- The cooking zone turns off automatically. *FE* flashes in the timer display alternatingly with *44*.

You can use the cooking zones again as usual when the fault message has gone out.

Cooling elements

- Any booster function in operation will be turned off.
- The power level that is set will be reduced.
- The cooking zones turn off automatically.

The affected cooking zones can only be used again if the cooling element has cooled down to a safe level.

Overheating can be caused by:

- Heating empty cookware
- Fats or oils being heated at high power settings
- Underside of cooktop insufficiently ventilated
- A hot cooking zone being turned on after a power outage

If, despite elimination of the cause, the overheat protection is triggered again, contact Miele Service.

Cleaning and care

 Risk of burning or scalding due to hot cooking zones.

The cooking zones will be hot after use.

Turn off the cooktop.

Allow the cooktop to cool down before cleaning.

 Risk of damage due to moisture ingress.

The steam from a steam cleaning appliance could reach live electrical components and cause a short circuit.

Do not use a steam cleaner to clean the cooktop.

All surfaces could be discolored or damaged if unsuitable cleaning agents are used. All surfaces are susceptible to scratching.

Remove all cleaning agent residues immediately.

Do not clean with any abrasive or sharp pointed objects.

- Clean the cooktop after every use.
- Dry the cooktop thoroughly after every cleaning to avoid limescale residue.

Unsuitable cleaning agents

To avoid damaging the surfaces of the appliance, do not use:

- liquid dish soap
- cleaning agents containing soda, alkalis, ammonia, acids, or chlorides
- cleaning agents containing limescale remover
- stain or rust removers
- abrasive cleaning agents, such as scouring powder, scouring liquid, or pumice stones
- cleaning agents containing solvents
- dishwasher cleaning agents
- grill and oven sprays
- glass cleaners
- hard, abrasive brushes or sponges (e.g., pot scourers), or sponges which have been previously used and still contain abrasive cleaning agents
- eraser sponges

Cleaning the ceramic surface

 Risk of damage caused by pointed objects.

The seal between the cooktop and the countertop could be damaged.

The seal between the ceramic surface and the frame could be damaged.

Do not use pointed objects for cleaning.

When cleaning with liquid dish soap, not all contaminants and residues are removed. An invisible film forms, which causes discoloration of the ceramic. This discoloration cannot be removed.

Clean the ceramic surface regularly with a suitable ceramic cooktop cleaning agent.

- First wipe down the surface with a damp cloth to loosen soiling, then remove stubborn crusting with a glass scraper.
- Then clean the ceramic surface with the Miele Ceramic and Stainless-Steel Cooktop Cleaner (see “Optional accessories – Cleaning and care products”) or with a proprietary ceramic cleaner applied with a paper towel or a clean cloth. Do not put the cleaner on a hot cooktop since this may cause spotting. Please follow the cleaning-agent manufacturer’s instructions.
- Finally wipe the cooktop with a damp cloth and dry it with a soft, dry cloth.

Residues can burn onto the cooktop the next time it is used and cause damage to the ceramic surface. Ensure that all cleaner residues are removed.

- **Spots** caused by limescale, water, and aluminum residues (spots with a metallic appearance) can be removed using the Miele Ceramic and Stainless-Steel Cooktop Cleaner.

 Risk of burning or scalding due to hot cooking zones.

The cooking zones are hot during use.

Wear pot holders and use a glass scraper to remove sugar, plastic, or aluminum foil residues from the hot cooktop.

- Should any **sugar, plastic, or aluminum foil** spill or fall onto a hot cooking zones while it is in use, first turn off the cooktop.
- Then carefully scrape off these residues **immediately** while they are still hot, using a shielded scraper blade.
- Afterwards, clean the ceramic surface in its cooled state, as described above.

Programming

You can adapt the programming of the cooktop to your personal needs. Several settings can be changed in succession.

After the programming function is started, *P* (program) and *S* (status) will appear in the timer display. With cooktops that have 3 cooking zones, an additional display appears at the back left.

The program is displayed in the front left and rear left control scales.

Example:

Program 3 =

Front left 3, rear left 0

Program 14 =

Front left 4, rear left 1

The status is displayed in the front right control scale.

After the programming function is exited, an automatic reset is performed. It is concluded when an indicator light lights up briefly via the ① sensor button.

Do not turn on the cooking zone until the reset is concluded.

Starting the programming function

- When **the cooking zone is turned off**, tap the ① and ② sensor buttons simultaneously until the indicator light for the safety lock flashes.

Setting a program

- To set the **ones digits**, tap the corresponding number on the **front left** control scale.
- To set the **tens digits**, tap the corresponding number on the **rear left** control scale.

Setting the status

- Touch the respective number on the **front right** control scale.



Saving the settings

- Touch the ① sensor until the indicators go out.

How to avoid saving the settings

- Touch the ② sensor until the indicators go out.

Programming

Program ¹⁾		Status ²⁾	Settings
P0	Demo mode and factory default settings	S0	Demo mode on ³⁾
		S1	Demo mode off
		S9	Factory default settings reinstated
P1	Stop & Go	S0	Off
		S1	On
P2	Number of power levels	S0	9 power levels
		S1	17 power levels ⁴⁾
P3	Audible signal for induction when there is no cookware or the cookware is unsuitable	S0	Off
		S1	Quiet
		S2	Medium
		S3	Loud
P4	Tone when a sensor control is touched	S0	Off
		S1	Quiet
		S2	Medium
		S3	Loud
P5	Audible signal for timer	S0	Off
		S1	Quiet
		S2	Medium
		S3	Loud
P6	System lock/Safety lock	S0	One-finger control with 
		S1	Three-finger control with simultaneous tapping of  and the  power level of both right cooking zones
P7	System lock	S0	System lock can only be activated manually
		S1	Manual and automatic activation of the system lock
P8	Auto heat-up	S0	Off
		S1	On

Programming

Program ¹⁾		Status ²⁾	Settings
P10	Miele@home/Con@ctivity – only on communication-enabled appliances retrofitted with a communication module/wireless stick –	S0	not currently available
		S1	logged out
		S2	logged in
P15	Audible signal if the sensors are covered	S0	Off
		S1	On
P16	Sensor controls reaction speed	S0	Slow
		S1	Normal
		S2	Fast

1) Programs not shown here have no allocation.

2) The factory setting is shown in bold.

3) After switching the cooktop on, *dE* appears in the timer display for several seconds.

4) In the text and charts, the extended power levels are shown with a dot after the number for better understanding.

Frequently Asked Questions

With the help of the following guide minor faults in the performance of the machine, some of which may result from incorrect operation, can be remedied without contacting the Service Department.

This guide may help you to find the reason for the fault, and how to correct it.

Problem	Possible cause and solution
<p>Cooktop or cooking zones cannot be turned on.</p>	<p>There is no power to the cooktop.</p> <ul style="list-style-type: none"> ■ Check if the breaker has tripped. Contact a qualified electrician or Miele Customer Service (for the minimum fuse rating, see data plate). <p>There may be a technical fault.</p> <ul style="list-style-type: none"> ■ Disconnect the cooktop from the electricity supply for approx. 1 minute by <ul style="list-style-type: none"> – tripping the relevant breaker or screwing the fuse out completely, or – switching off the residual current device. ■ If the cooktop will still not turn on after resetting the breaker or the residual current device, contact a qualified electrician or Miele Customer Service.
<p>There is a strange smell or vapors when the cooktop is being used for the first time.</p>	<p>The metal components have a protective coating. When the cooktop is used for the first time, this causes a smell and possibly also vapor. The material from which the induction coils are made also gives off a smell in the first few hours of operation. With each subsequent use, the odors are reduced until they disappear completely. The smell and any vapors do not indicate a faulty connection or a defective appliance and are not harmful to your health.</p>
<p>Power levels 1 to 9 flash.</p>	<p>There is no or unsuitable cookware on the cooking zone.</p> <ul style="list-style-type: none"> ■ Use a suitable pan (see “Cookware”).
<p>After the cooktop has been switched on, <i>LL</i> appears in the timer display for a few seconds.</p>	<p>The system lock or safety lock is activated.</p> <ul style="list-style-type: none"> ■ Deactivate the system lock or safety lock (see “Safety features – System lock/Safety lock”).

Frequently Asked Questions

Problem	Possible cause and solution
F flashes in the timer display and the cooktop switches off automatically.	One or more of the sensor controls are covered, e.g., by finger contact, food boiling over, or an object. <ul style="list-style-type: none"> ■ Clean off any dirt and/or remove the object (see “Safety features – Safety shut-off”).
After turning on the cooktop, <i>dE</i> appears in the timer display for several seconds. The cooking zones don't heat up.	The cooktop is in demo mode. <ul style="list-style-type: none"> ■ Deactivate demo mode (see “Programming”).
A cooking zone turns itself off automatically.	It might have been turned on for too long. <ul style="list-style-type: none"> ■ You can use the cooking zone again by turning it back on (see “Safety features – Safety shut-off”).
A cooking zone or the whole cooktop switches off automatically.	Overheating protection has been triggered. <ul style="list-style-type: none"> ■ See “Safety features – Overheating protection”.
The booster has automatically turned off early.	Overheating protection has been triggered. <ul style="list-style-type: none"> ■ See “Safety features – Overheating protection”.
The cooking zone is not working in the usual way with the set power level.	Overheating protection has been triggered. <ul style="list-style-type: none"> ■ See “Safety features – Overheating protection”.
Power setting 9 is automatically reduced if you select power setting 9 on the linked cooking zone.	Operating both zones at power level 9 would exceed the permitted maximum power for the cooktop. <ul style="list-style-type: none"> ■ Use another cooking zone that is not linked.
Auto Heat-up is turned on, but the food does not start cooking.	Large amounts of food are being heated. <ul style="list-style-type: none"> ■ Start cooking at the highest power level, then reduce the power level manually.
	The pan is not conducting heat properly. <ul style="list-style-type: none"> ■ Use a different pan that is able to better conduct heat on an induction cooktop.
A noise can be heard after the appliance is turned off.	The fan will continue running until the cooktop has cooled down. It will then turn itself off automatically.

Frequently Asked Questions

Problem	Possible cause and solution
One or more residual heat indicators is flashing.	<p>There was a power failure during operation or when residual heat was present.</p> <p>You called the programming function while residual heat was still present.</p>
The sensor buttons are over-sensitive or do not react at all.	<p>The sensitivity level of the sensor buttons has changed.</p> <ul style="list-style-type: none"> ■ Ensure that the cooktop is not in direct sunlight or strong artificial light and that the area around the cooktop is not too dark. ■ Make sure that there is nothing covering the sensor buttons or the cooktop. Take any pans off the cooktop and wipe away any food deposits. ■ Interrupt the power supply to the cooktop for approx. 1 minute. ■ If the problem persists after power is restored, please contact Miele Service.
FE Alternating with a number flashes in the timer display.	<p><i>FE44</i></p> <p>The overheat protection was triggered.</p> <ul style="list-style-type: none"> ■ See “Overheat protection.”
	<p><i>FE47 or FE48</i></p> <p>The fan is blocked or defective.</p> <ul style="list-style-type: none"> ■ Make sure it has not been blocked by something like a fork. Remove the cause of the blockage. ■ If this fault message continues to appear in the display, contact Miele Service.
	<p><i>FE</i> and other numbers</p> <p>There is a fault in the electronic module.</p> <ul style="list-style-type: none"> ■ Interrupt the power supply to the cooktop for approx. 1 minute. ■ If the problem persists after power is restored, please contact Miele Service.

Con@ctivity

Your cooktop is communication enabled and can communicate with the ventilation hood using the wireless USB stick included with selected ventilation hoods (Con@ctivity). The cooktop sends information on its operating status to the ventilation hood. The operation of the ventilation hood is automatically controlled by the power setting of the connected cooktop.

If you want to log your cooktop onto **Con@ctivity**, you must first log on to the ventilation hood.

Logging on the cooktop

- When **the cooking zone is turned off**, tap the ① and  sensor buttons simultaneously until the indicator light for the safety lock flashes.

In the timer display, *P* (program) and 5 (status) appear. The program number will be displayed to the left of the control scales and the set status to the right.

- Tap sensor button 1 on the **rear left** control scale (set program 10).
- Tap sensor button 2 on the **right front** control scale (set Status 2 = log-on).

The log-on procedure starts and sensor button 2 flashes on the right front of the control scale. The log-on procedure will take a few minutes. Sensor button 2 lights up constantly as soon as the procedure has been completed successfully.

- To save the setting, tap the ① sensor button until the indicators go out.

- Conclude the log-on on the hood/display devices (see the corresponding instructions).

Logging off the cooktop

- When **the cooking zone is turned off**, tap the ① and  sensor buttons simultaneously until the indicator light for the safety lock flashes.

In the timer display, *P* (program) and 5 (status) appear. The program number will be displayed to the left of the control scales and the set status to the right.

- Tap sensor button 1 on the **rear left** control scale (set program 10).
- Tap sensor button 1 on the **right front** control scale (set Status 1 = log-off).

The log-off procedure starts and sensor button 1 flashes on the right front of the control scale. The log-off procedure will take a few minutes. Sensor button 1 lights up constantly as soon as the procedure has been completed successfully.

- To save the setting, tap the ① sensor button until the indicators go out.

Contact in the event of a fault

In the event of a fault which you cannot remedy yourself, please contact your Miele dealer or Miele Customer Service.

You can book a Miele Service Call online at www.miele.com/service.

Contact information for Miele Customer Service can be found at the end of this document.

Please quote the model identifier and serial number of your appliance (SN) when contacting Miele Customer Service. Both pieces of information can be found on the data plate.

Appliance warranty and product registration

You can register your product and/or view the manufacturer's warranty terms and conditions for Miele appliances and vacuum cleaners at www.mieleusa.com.

Installation

IMPORTANT SAFETY INSTRUCTIONS - INSTALLATION

 Risk of damage caused by incorrect installation.
Incorrect installation can damage the cooktop.
The cooktop must only be installed by a qualified specialist.

 Risk of electric shock from voltage.
Incorrect connection to the power supply may result in an electric shock.
The cooktop must be connected to the electrical supply by a qualified person only.

 Damage from falling objects.
Take care not to damage the cooktop when installing cabinetry or a ventilation hood above it.
Install the cabinetry and ventilation hood before installing the cooktop.

- ▶ Reaching over a hot cooktop to access the cabinets can result in burns. You can reduce the risk of burns by installing a ventilation hood that extends at least 4 ¾" (12 cm) past the bottom of the cabinets. Do not install any cabinets above the cooktop.
- ▶ The countertop must be heat-resistant (up to 212°F / 100°C), so that it does not become deformed or the veneer detached. The wall strips must be heat-resistant as well.
- ▶ The cooktop must not be installed above refrigerators/freezers, dishwashers, or washer/dryers.
- ▶ This cooktop may only be installed above a stove or oven if they have a built-in cooling fan.
- ▶ Ensure that the power cord cannot be touched after the cooktop has been installed.
- ▶ After the installation of the cooktop, the electrical cord may not come into contact with any moving kitchen parts (e.g. a drawer) or be subject to mechanical stress.
- ▶ Observe carefully the safety clearances listed on the following pages.

Safety distances

Safety clearance above the cooktop

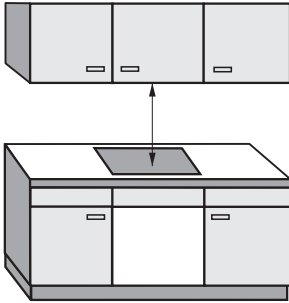

For a ventilation hood above the cooktop, always use the clearance specified by the hood manufacturer. If there are no specifications from the hood manufacturer or if flammable materials (e.g. a utensil rail) are installed above the cooktop, the clearance must be at least 30" (760 mm).

If there is more than one appliance installed below the ventilation hood, each with a different safety clearance, the largest clearance must be used.

Installation

Safety clearances to the sides and back of the cooktop

When installing a cooktop there may be an optionally high cabinet or room wall against the rear side and one of the sides (right **or** left) (see illustrations).

① minimum distance between the **back** of the counter cut-out and the rear edge of the counter:
2" (50 mm)

② minimum distance to the **right** of the counter cut-out to the closest adjacent piece of cabinetry (for instance, a high cabinet) or a room wall:
2" (50 mm)

③ minimum distance to the **left** of the counter cut-out to the closest adjacent piece of cabinetry (for instance, a high cabinet) or a room wall:
2" (50 mm)

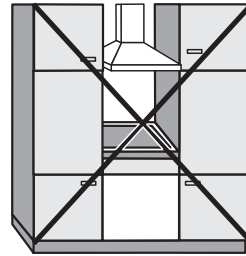

Not allowed

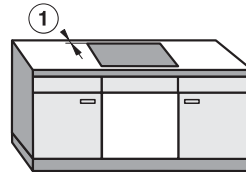
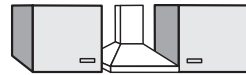

Highly recommended

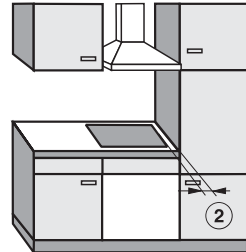

Not recommended

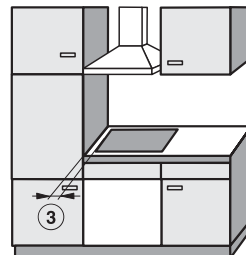

Not recommended

Minimum clearance underneath the cooktop

To ensure proper ventilation of the cooktop, a minimum clearance is required between the appliance and an oven, protective base, or drawer.

The minimum clearance from the bottom of the cooktop to

- the top of the **oven** must be $\frac{9}{16}$ " (15 mm).
- the top of the **protective base** must be $\frac{9}{16}$ " (15 mm).
- bottom of the **drawer** must be 3" (75 mm).

Protective base

Installation of a protective base under the cooktop is allowed but not required.

A gap of 3" (75 mm) at the back is required for the power supply cord. For better cooling of the cooktop, we recommend a gap of 2" (50 mm) at the front.

Installation

Safety distance from the wall covering

If a wall covering is installed, a minimum safety distance must be maintained between the countertop cut-out and the covering, since high temperatures can damage these materials.

If the covering is made of a combustible material (such as wood), the distance between the countertop cut-out and the wall covering must be a minimum of 2" (50 mm).

For coverings made of non-combustible materials (such as metal, marble, granite, ceramic tiles) the minimum safety distance between the countertop cut-out and the wall covering must be 2" (50 mm) minus the thickness of the covering. For example: thickness of wall covering 2" (50 mm) - $\frac{9}{16}$ " (15 mm) = minimum safety distance $1\frac{7}{16}$ " (35 mm).

Flush-mounted cooktops

Framed cooktops

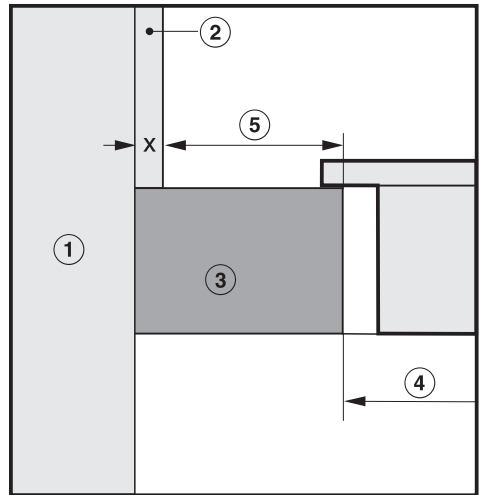
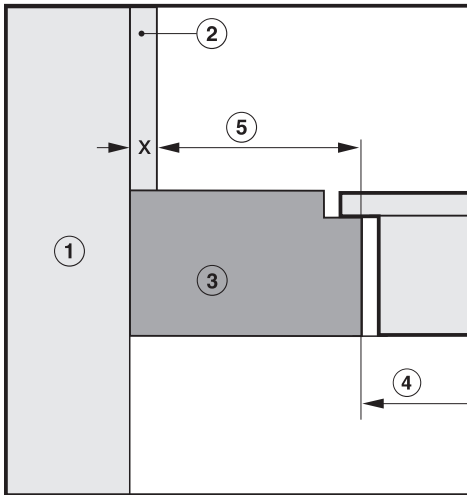



- ① Wall frame
- ② Wall covering dimension x = thickness of the niche cladding
- ③ Countertop
- ④ Countertop cut-out
- ⑤ Minimum distance for
flammable materials 2" (50 mm).
non-flammable materials 2" (50 mm) - dimension x

Installation notes

Proud installation

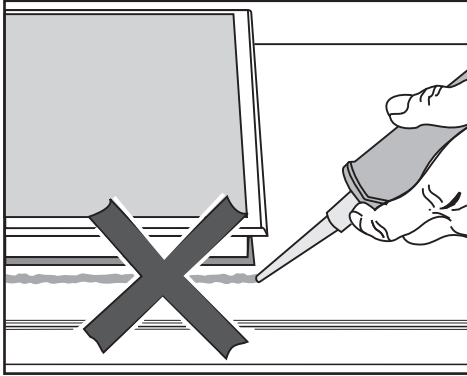
Seal between cooktop and countertop



 **Damage caused by incorrect installation.**

Using sealant under the cooktop could result in damage to the cooktop and the countertop if the cooktop ever needs to be removed for servicing.

Do not use sealant between the cooktop and the countertop.

The sealing strip under the edge of the cooktop provides a sufficient seal for the countertop.

Sealing strip

Dismantling the cooktop for service purposes may damage the sealing strip underneath the edge of the cooktop.

Always replace the sealing strip before reinstalling the cooktop.

Tiled countertop

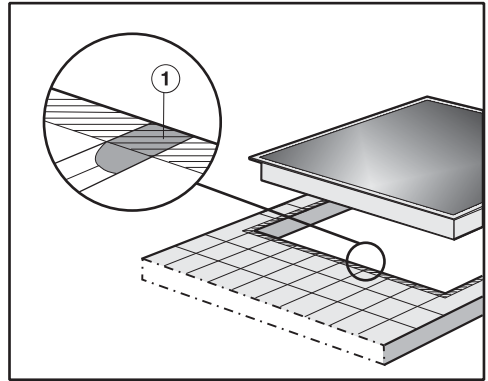

Grout lines ① and the shaded area under the cooktop frame must be smooth and even. If they are not, the cooktop will not sit flush with the countertop and the sealing strip underneath the cooktop will not provide a good seal between the cooktop and the countertop.

Installation

Flush installation

Flush installation is only possible in natural-stone (granite, marble), solid-wood, and tiled countertops. Certain cooktops are suitable for building into glass countertops – these are labeled accordingly. When using a countertop made from any other material, please check first with the countertop manufacturer that it is suitable for installing a flush cooktop.

The internal width of the base unit underneath the appliance must be at least as wide as the inner countertop cut-out (see “Installation – Installation dimensions – Flush”), so that the cooktop is easily accessible from underneath after installation and the bottom half of the casing can be removed for maintenance. If the underside of the cooktop is not freely accessible after installation, any sealant must be removed to enable the cooktop to be lifted out.

Natural-stone countertops

The cooktop is set directly in the cut-out.

Solid-wood countertops, tiled countertops, glass countertops

The cooktop is secured inside the cut-out with wooden battens. The frame must be provided on site and is not supplied with the appliance.

Ventilation

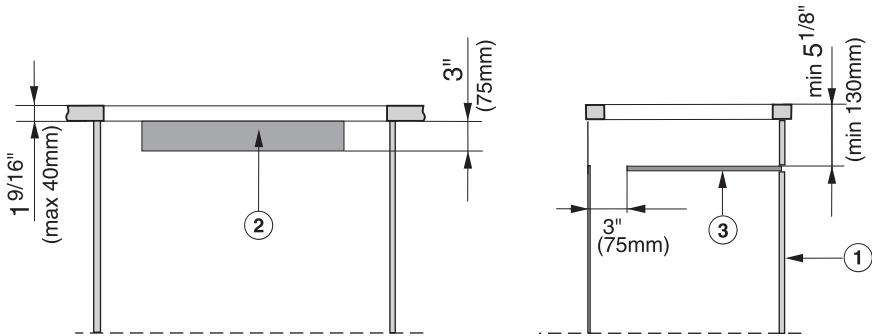

① Front

② Ventilation cut-out in the rear wall of the base unit
(Slight) ventilation also takes place when the base unit is directly against the wall.

③ Protective base

The installation of a protective base beneath the cooktop is not required, but permitted.

If a protective base is installed, the distance between the top edge of the countertop and the top edge of the base must be at least $5\frac{1}{8}$ " (130 mm) for proper ventilation of the cooktop.

Leave an air gap of 3" (75 mm) at the back for the power cord.

Cooktop	Dimensions of the ventilation cutout
KM 6360, KM 6365	$24\frac{1}{2}$ " x 3" (622 x 75 mm)
KM 6370, KM 6375	30" x 3" (762 x 75 mm)
KM 6377	$35\frac{1}{2}$ " x 3" (902 x 75 mm)

Installation

Installation dimensions – Proud

All dimensions in this instruction booklet are given in mm and inches.

KM 6360

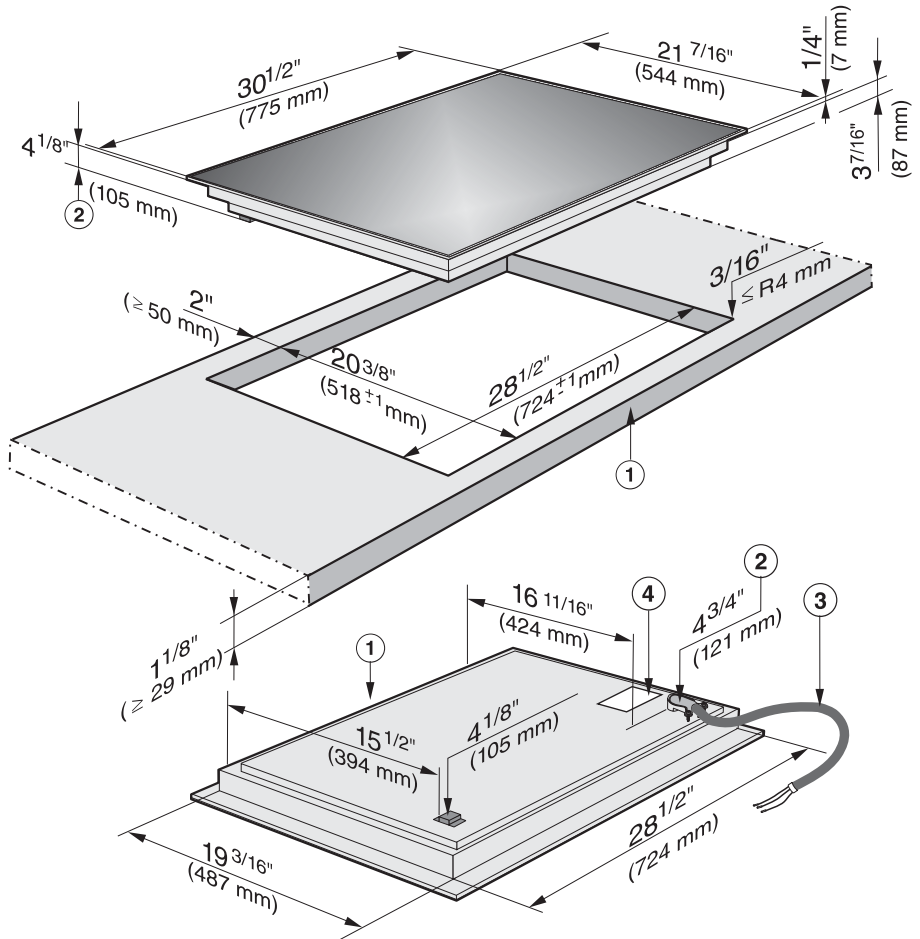

- ① Front
- ② Installation height
- ③ Flexible metal hose with power cord L = 4' (1,200 mm)
- ④ Data plate

Installation

KM 6377

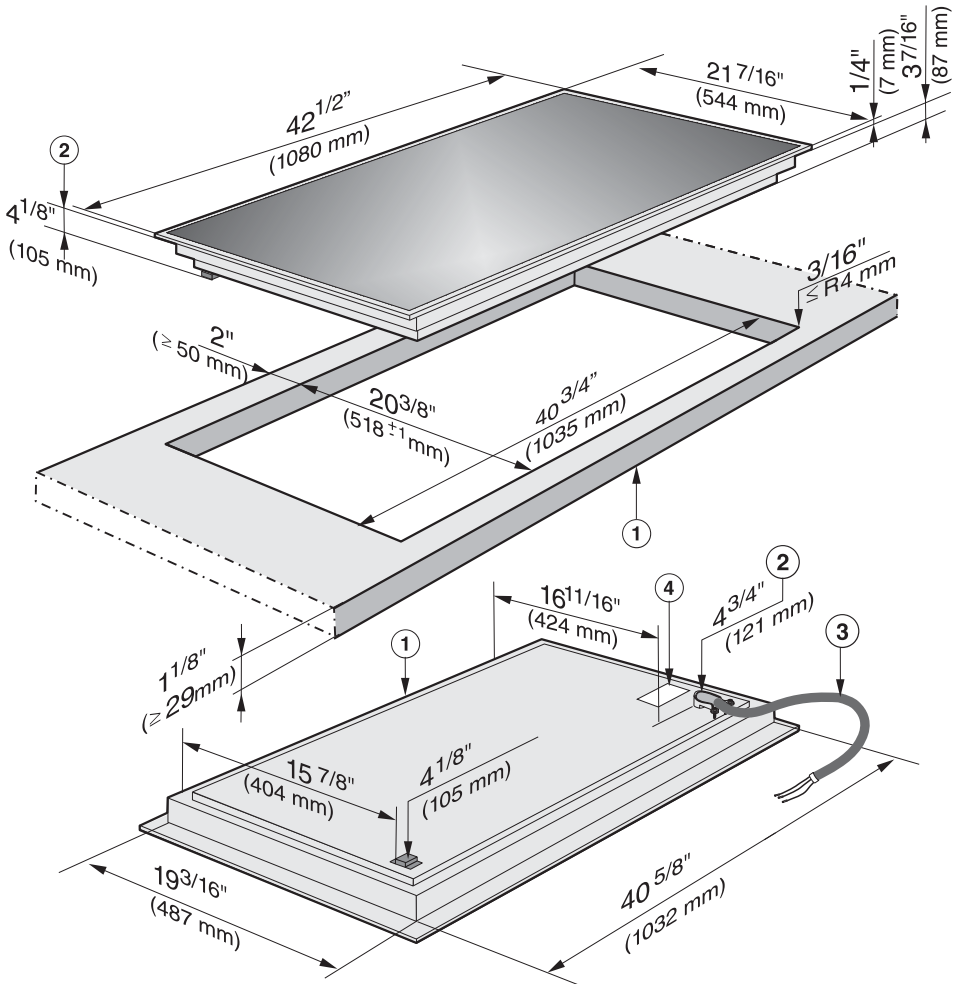

- ① Front
- ② Installation height
- ③ Flexible metal hose with power cord L = 4' (1,200 mm)
- ④ Data plate

Proud installation

- Create the countertop cut-out. Remember to maintain the minimum safety distances (see “Installation – Safety distances”).
- Seal any cut surfaces on **wooden countertops** with a special varnish, silicone rubber, or resin to prevent the wood from swelling as a result of moisture. The sealant must be temperature-resistant.

Ensure that the sealant does not get on the top surface of the countertop.

- Attach the sealing strip provided underneath the edge of the cooktop. Do not apply the sealing strip under tension.
- Feed the cooktop power cord down through the cut-out in the countertop.
- Place the cooktop centrally in the cut-out. When doing this make sure that the seal of the appliance sits flush with the countertop on all sides. This is important to ensure an effective seal all round.

Do not use any additional sealant (e.g., silicone) on the cooktop.

If the seal does not sit flush with the countertop in the corners, the corner radius ($\leq R4$) can be carefully cut to fit using a jigsaw.

- Connect the cooktop to the electrical power supply.
- Check that the cooktop works.

KM 6375

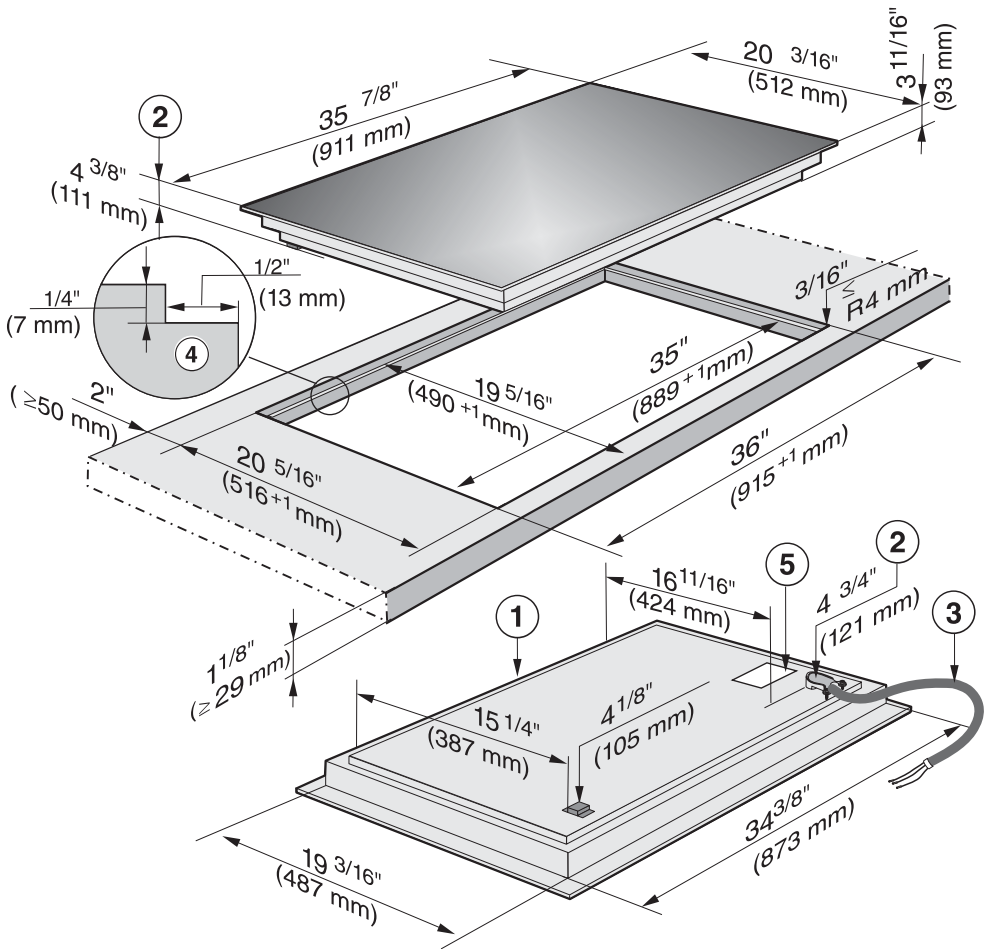

- ① Front
- ② Installation height
- ③ Flexible metal hose with power cord, L = 4' (1,200 mm)
- ④ Data plate

Cut-out dimensions for granite or marble counters. Please take careful note of the diagram.

Installation

Flush installation

Granite and marble counters

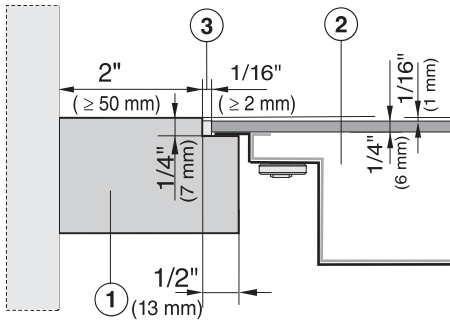

- ① Countertop
- ② Cooktop
- ③ Gap

As the ceramic glass slab and the counter cut-out have a certain dimensional tolerance, the width of the gap ③ (min. $\frac{1}{16}$ " [2 mm]) can vary.

KM 6365

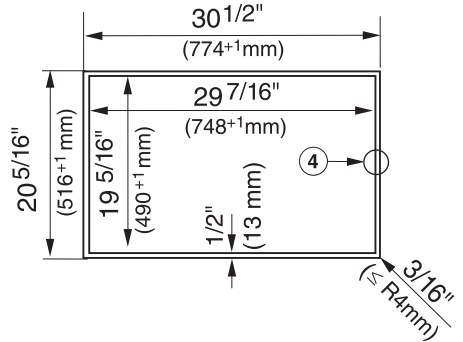

- ④ Stepped cut-out

KM 6375

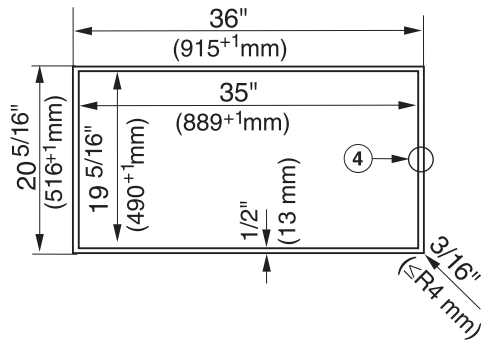

- ④ Stepped cut-out

Solid wood / tiled / glass counters

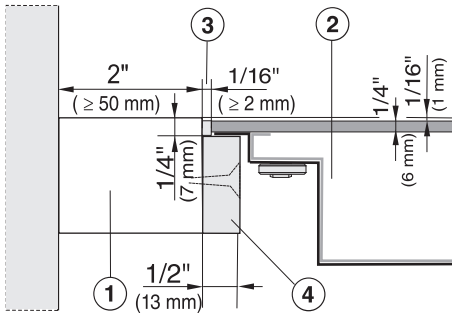

- ① Countertop
- ② Cooktop
- ③ Gap
- ④ Wooden frame 1/2" (13 mm) (not supplied with appliance)

As the ceramic glass slab and the counter cut-out have a certain dimensional tolerance, the width of the gap ③ (min. 1/16" [2 mm]) can vary.

- Create the countertop cut-out. Remember to maintain the minimum safety distances (see "Installation – Safety distances").
- Solid-wood, tiled, and glass countertops:
Fix a wooden frame 1/4" (7 mm) below the top edge of the countertop.
- Feed the cooktop power cord down through the countertop cut-out.
- Center the cooktop in the cut-out.

The gap between the ceramic surface and the countertop must be at least 1/16" (2 mm) wide. This is required so that the cooktop can be sealed.

- Connect the cooktop to the electrical power supply.
- Check that the cooktop works.
- Seal the gap between the cooktop and countertop with a silicone sealant that is heat-resistant to at least 320°F (160°C).

⚠ Damage caused by unsuitable sealant.
Unsuitable sealant can damage natural stone.
For natural-stone countertops and natural-stone tiles, only use silicone sealant that is specially formulated for natural stone. Please follow the manufacturer's instructions.

Installation

Electrical connection



ATTENTION:

Before installation or servicing, disconnect the power supply by either removing the fuse, shutting off the main power or manually “tripping” the circuit breaker.

Installation work and repairs should only be performed by a qualified technician in accordance with all applicable codes and standards. Repairs and service by unqualified persons could be dangerous and the manufacturer will not be held responsible. Installation, repair, and maintenance work should only be performed by a Miele-authorized service technician. Work by unqualified persons can cause considerable danger to users. Miele cannot be held liable for any damage arising as a result of such work.

Before connecting the appliance to the power supply, make sure that the voltage and frequency listed on the rating label correspond with the household electrical supply. This data must correspond to prevent appliance damage. Consult an electrician if in doubt.

For safety reasons, the cooktop may only be used when it has been fully installed into the countertop.

To guarantee the electrical safety of this appliance, continuity must exist between the appliance and an effective grounding system. It is imperative that this basic safety requirement be met. If there is any doubt, have the electrical system of the house checked by a qualified electrician.

Installation, repair and maintenance work should only be performed by a Miele-authorized qualified electrician in compliance with local regulations and the ANSI National Electrical Code / NFPA 70 in the United States or the Canadian Electric Code, CSA C22.1-02. in Canada.

Installer:

- Please leave these instructions with the customer.

Connection

- Ensure that the connection data on the data plate (voltage, frequency, and fuse rating) match those of your electrical supply.

The data plate is located underneath the cooktop.

The cooktop is approved and ready for connection to a grounded connector with three connecting wires, sheathed by a flexible metal hose.

It must be connected to an assigned line in an approved connecting socket.

The appliance must be able to be disconnected from the power supply on all poles by disconnecting devices! (When turned off, a contact distance of at least $\frac{1}{8}$ " (3 mm must be present!)) The disconnecting devices are overcurrent protection elements and protective circuit breakers.

Black: Connect to L1 (hot)

Red: Connect to L2 (hot)

Green: Connect to GND (ground)

KM 6360, KM 6365

208/240 V, 60 Hz, 40 A

KM 6370, KM 6375, KM 6377

208/240 V, 60 Hz, 50 A

Make sure that the connecting socket is accessible after the installation of the cooktop.

Further information can be found on the included data plate.



WARNING:
THIS COOKTOP MUST BE
GROUNDED

MieleCare

This service is available in USA only.

MieleCare, our Extended Service Contract program, gives you the assurance of knowing that your appliance investment is covered by 5 years of worry free ownership.

MieleCare is the only Extended Service Contract in the industry that guarantees repairs by a Miele Authorized Service Provider using genuine Miele parts. Only genuine Miele parts installed by factory trained professionals can guarantee the safety, reliability, and longevity of your Miele appliance.

Please note that unless expressly approved in writing by Miele's Service department, Extended Service Contracts offered by other providers for Miele products will not be recognized by Miele. Our goal is to prevent unauthorized (and untrained) service personnel from working on your Miele products, possibly doing further damage to them, you and/or your home.

To learn more about **MieleCare** Extended Service Contracts, please contact your appliance dealer or visit us online at:

www.mieleusa.com

**Please have the model and serial number
of your appliance available when
contacting Customer Service.**

U.S.A.

Miele, Inc.

National Headquarters

9 Independence Way
Princeton, NJ 08540

Customer Service & Support

Phone: 888-99-MIELE(64353)
info@mieleusa.com
www.mieleusa.com

International Headquarters

Miele & Cie. KG
Carl-Miele-Straße 29
33332 Gütersloh
Germany

Canada

**Importer
Miele Limited**

Headquarters and Miele Centre

161 Four Valley Drive
Vaughan, ON L4K 4V8
www.miele.ca

Customer Care Centre

Phone: 800-565-6435
905-532-2272
customercare@miele.ca

KM 6360, KM 6365, KM 6370, KM 6375, KM 6377

en-US

M.-Nr. 09 888 630 / 06