

# Haier

## GAS HOB

HCG302WFCX3  
HCG604WFCX3  
HCG604WFCG3  
HCG905WFCX3  
HCG905WFCG3

## INSTALLATION & USER GUIDE

NZ AU

## CONTENTS

Safety and Warnings _____	4
Parts Supplied _____	7
Product Dimensions _____	7
Cutout & Clearance Dimensions _____	8
Installation Instructions _____	9
Product Overview _____	13
Using Your Cooktop _____	14
Cooking Guidelines _____	15
Care & Cleaning _____	15
Troubleshooting _____	16
Technical Specifications _____	17
Manufacturer's Warranty _____	18
Customer Care _____	19

## SAFETY AND WARNINGS

Your safety is important to us. Please read this information before using your cooktop.

### INSTALLATION

WARNING!	
	<p><b>Electric Shock Hazard</b>  <b>Failure to follow this advice may result in electric shock or death.</b></p> <ul style="list-style-type: none"> <li>• Disconnect the appliance from the mains electricity supply before carrying out any work or maintenance.</li> <li>• Connection to a good earth wiring system is essential and mandatory.</li> <li>• Alterations to the domestic wiring system must only be made by a qualified electrician.</li> </ul>

WARNING!	
	<p><b>Cut Hazard</b>  <b>Failure to use caution could result in injury.</b></p> <ul style="list-style-type: none"> <li>• Take care: some edges are sharp</li> </ul>

### IMPORTANT SAFETY INSTRUCTIONS!

- Read these instructions carefully before installing this product.
- Save these instructions for the local electrical inspector's use.
- Installation must comply with your local building and local electricity regulations.
- This appliance is to be installed and serviced only by trained and supported service technician or qualified person.
- The manufacturer accepts no responsibility for the incorrect installation of appliances.
- Incorrect installation may result in personal injury, damage to property and may invalidate any warranty or liability claims.
- Packing elements (eg plastic bags, polystyrene foam, staples, packing straps etc) and tools should not be left around during and after installation, especially if they are within easy reach of children, as these may cause serious injuries.
- Make sure you recycle the packaging material.
- Before disposing of any appliance, make sure that it can no longer be used and that all hazardous parts are removed or made harmless, so that children playing with the old appliance cannot harm themselves.
- These appliances are registered in: New Zealand at [www.energysafety.govt.nz](http://www.energysafety.govt.nz) and IAPMO Oceana at [www.iapmooceana.org](http://www.iapmooceana.org)
- Appliances are factory set for natural gas but are convertible to ULPG. If in doubt, refer to the local gas network operator or gas supplier to confirm gas type at installation site.
- Do not modify this appliance.
- Do not use or store flammable materials on or near this appliance.
- Do not spray aerosols in the vicinity of this appliance while it is in operation.

OPERATION AND MAINTANENCE

<b>WARNING!</b>	
	<p><b>Electric Shock Hazard</b>  <b>Failure to follow this advice may result in electric shock or death.</b></p> <ul style="list-style-type: none"> <li>• Switch the power to the cooktop off at the wall before cleaning or maintenance.</li> <li>• Do not cook on a broken or cracked cooktop. If the glass should break or crack, turn off the gas supply and switch the appliance off immediately at the mains power supply (wall switch) and contact a qualified technician.</li> </ul>

<b>WARNING!</b>	
	<p><b>Fire Hazard</b>  <b>Failure to follow this advice may result in serious injury.</b></p> <ul style="list-style-type: none"> <li>• Never leave the appliance unattended when in use. Boilover causes smoking and greasy spillovers that may ignite.</li> </ul>

<b>WARNING!</b>	
	<p><b>Poisoning Hazard</b>  <b>Failure to follow this advice may result in poisoning or death.</b></p> <ul style="list-style-type: none"> <li>• Never use this appliance as a space heater to heat or warm the room. Doing so may result in carbon monoxide poisoning and overheating of the appliance.</li> </ul>

<b>WARNING!</b>	
	<p><b>Explosion Hazard</b>  <b>Failure to follow this advice may result in death or serious injury.</b></p> <ul style="list-style-type: none"> <li>• Do not use or store flammable materials such as gasoline near this appliance.</li> <li>• Do not spray aerosols in the vicinity of this appliance while it is in operation.</li> </ul>

<b>WARNING!</b>	
	<p><b>Hot Surface Hazard</b>  <b>Failure to follow this advice may result in serious injury.</b></p> <ul style="list-style-type: none"> <li>• This appliance becomes hot during use. Do not touch the cooktop components, burners, pan supports or the glass when hot.</li> <li>• Before cleaning, turn the burners off and make sure the whole cooktop is cool.</li> </ul>

**IMPORTANT SAFETY INSTRUCTIONS!**

- Keep children away from the cooktop when it is in use.
- Household appliances are not intended to be played with by children.
- Children of less than 8 years old must be kept away from the appliance unless continuously supervised. This appliance can be used by children aged from 8 years and above, and persons with reduced physical, sensory or mental capabilities or lack of experience and knowledge, if they have been given supervision or instruction concerning the use of the appliance in a safe way and they understand the hazards involved. Cleaning and user maintenance shall not be done by children without supervision.
- If the electrical supply cord is damaged, it must only be replaced by an authorised person.
- If the appliance is connected to the gas supply with a flexible hose, make sure that the hose cannot come in contact with the bottom of the appliance or any sharp edges.
- Ensure that the electrical connection plug is accessible after installation.
- Do not use an asbestos mat or decorative covers between the flame and the saucepan as this may cause serious damage to your cooktop.
- Do not place aluminium foil or plastic dishes on the cooktop burners.
- Do not let large saucepans, frying pans or woks push any other pans aside. This could make them unstable or deflect heat onto your benchtop and damage the surface.
- Do not use a steam cleaner for cleaning this cooktop.
- Saucepan handles may be hot to touch. Ensure saucepan handles do not overhang other gas burners that are on. Keep handles out of reach of children.
- Do not stand or place heavy objects on this appliance.
- After use, ensure that the burner dials are in the 'OFF' (o) position.
- Where this appliance is installed in marine craft or in caravans, it shall not be used as a space heater.
- Take care not to drop any heavy or sharp objects on the cooktop. The glass is tough, but sharp or heavy objects falling on it (e.g. pepper mill, heavy-based frying pan) may crack or chip it.
- The use of a gas cooking appliance results in the production of heat and moisture in the room in which it is installed. Ensure the kitchen is well ventilated. Keep natural ventilation holes open or install a mechanical ventilation device (mechanical extractor hood). Prolonged intensive use of the appliance may call for additional ventilation, for example opening of a window, or more effective ventilation, for example increasing the level of mechanical ventilation where present.
- After having unpacked the appliance, check to ensure that it is not damaged. In case of doubt, do not use it and consult your supplier or a professionally qualified technician.
- Packing elements (eg plastic bags, polystyrene foam, nails, packing straps, etc.) should not be left around within easy reach of children, as these may cause serious injuries.
- Do not modify this appliance.
- This appliance is to be serviced only by trained and supported service technician or qualified electrician in order to avoid a hazard.
- Some products are supplied with protective film on steel and aluminium parts. This film must be removed before using the appliance.
- Never leave the cooktop unattended when in use. Boil-over causes smoking and greasy spills that may ignite.
- Never allow flames to extend beyond cookware or curl up its sides. This could discolor and damage the utensil and you may get burned touching a hot handle.
- Keep handles out of the way. Turn handles so that they don't extend over the edge of the cooktop or another burner that is on.
- Take care when deep-frying. Oil or fat can overheat quickly, particularly on a high.
- This appliance is designed for domestic cooking only, commercial catering may invalidate the warranty.

## PARTS SUPPLIED

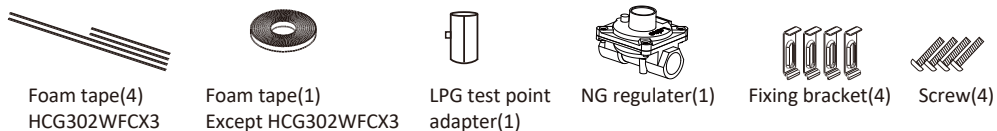

## PRODUCT DIMENSIONS

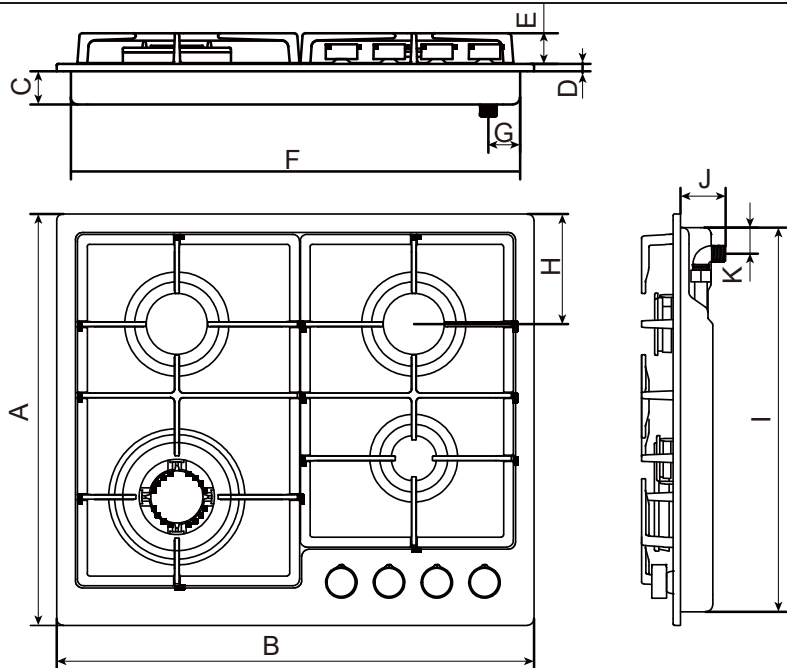

(MM)	A	B	C	D	E	F	G	H	I	J	K
HCG302WFCX3	515	297	35	10	35	278	35	130	495	47	37
HCG604WFCX3	500	580	39	10	39	546	33	134	467	55	18
HCG604WFCG3	500	580	45	8	45	546	37	134	467	59	34
HCG905WFCX3	500	860	38	10	38	822	43	113	469	52	24
HCG905WFCG3	510	860	45	8	45	822	43	120	469	58	24

## CUTOUT & CLEARANCE DIMENSIONS

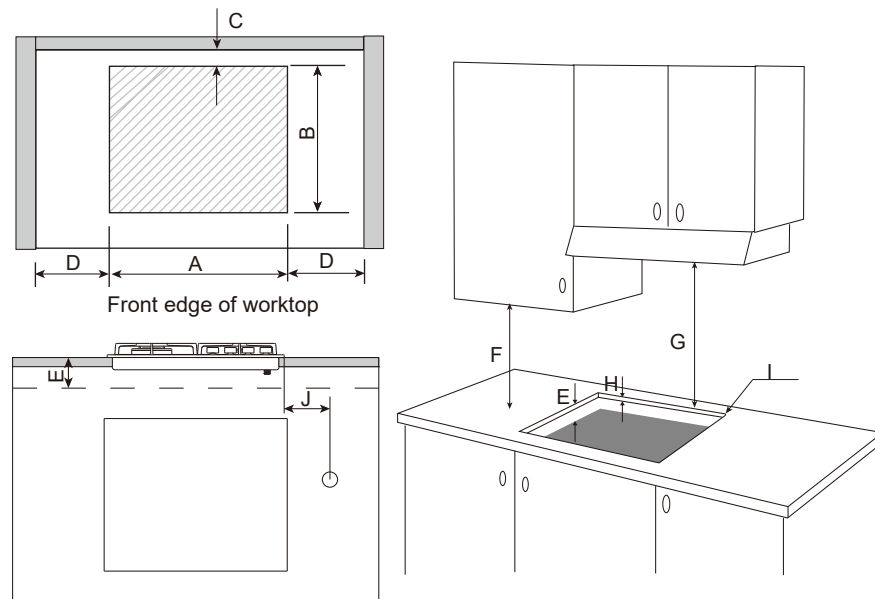

(MM)	A	B	C	C*	D	E	F	G	H	I	J
			(min)	(min)	(min)	(min)	(min)	(min)			(min)
HCG302WFCX3	283	498	45	160	150	90	400	650	40-50	R10	250
HCG604WFCX3	557	477	45	160	150	90	400	650	40-50	R10	250
HCG604WFCG3	557	477	45	160	150	90	400	650	40-50	R10	250
HCG905WFCX3	832	477	45	160	150	90	400	650	40-50	R10	250
HCG905WFCG3	832	477	45	160	150	90	400	650	40-50	R10	250

C is the rear clearance from rear edge of the cutout to nearest **non-combustible** surface (i.e., splash-back)

C\* is the rear clearance from rear edge of the cutout to nearest **combustible** surface (i.e., splash-back)

D is minimum clearance from side edges of the cutout to nearest **combustible** surface

E is minimum clearance below top of benchtop to a combustible surface

H is recommended benchtop thickness which is to be minimum 40 mm and maximum 50 mm.

I is the max allowed corner radius of the cut out

J describes the recommended location for gas supply

### Install above a drawer

When fitting a gas hob above a drawer or standard housing unit, suitable precautions must be taken to prevent contact with the casing of the hob which becomes very hot during operation. The recommended method for overcoming this problem is to fix a wooden panel (non-combustible) within the cabinet at a distance of minimum 90mm below the benchtop (see dimension E above).

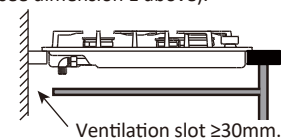

This panel must have adequate ventilation (minimum 30 mm) to the rear as shown in above diagram. The panel underneath the hob must be easily removable to allow for any servicing requirements

## INSTALLATION INSTRUCTIONS

### Before You Start

Make sure that:

- The cooktop has not been damaged during transport. In case of doubt after unpacking and checking it, contact the retailer.
- The local distribution conditions (nature of gas and pressure) and the adjustment of the cooktop (as detailed on the appliance data label and in the 'Gas rate and injector size table' further below) are compatible.
- The cooktop will be connected to a 220-240 V 50 Hz power supply and earthed via the power supply.
- There is an earthed power outlet within the reach of the cooktop's power supply cable.
- Both the power outlet and gas supply connection point will be accessible after installation.
- The power supply cable will not touch any hot or metal parts.
- A suitable isolating switch providing full disconnection from the mains power supply is incorporated in the permanent wiring, mounted and positioned to comply with local wiring rules and regulations. The isolating switch must be of an approved type and provide a 3mm air gap contact separation in all poles (or in all active [phase] conductors if the local wiring rules allow for this variation of the requirements).
- The isolating switch will be accessible after installation.
- The benchtop is made of a heat-resistant material.
- Exposed bare edges of the cutout are sealed with an oil-based paint or moisture proof polyurethane to prevent possible damage from moisture creeping between the cooktop trim and the benchtop.

### Unpacking the Appliance

Remove all packaging and recycle responsibly. Some parts on the appliance are protected by plastic film which must be removed before the appliance is used. The packaging materials should be carefully discarded and not left within easy reach of children as they are a potential hazard.

### Apply Adhesive Foam Tape Around the Edge & Fit the Elbow On the Cooktop Gas Inlet

Turn the cooktop over and place it on a soft surface. Peel off the backing on the foam seals ensuring that the transparent film still adheres to the seal. Apply the seal (S) – adhesive side facing down - around the edge of the cooktop so that the edge of the seal lines up with the outer edge of the cooktop. The ends of the strips should join without overlapping. Secure the seal to the cooktop by pressing it firmly in place.

Fit the 1/2" BSP external thread elbow (C) and washer (A) to the floating nut (B). It is important to use washer (A) to ensure a tight seal.

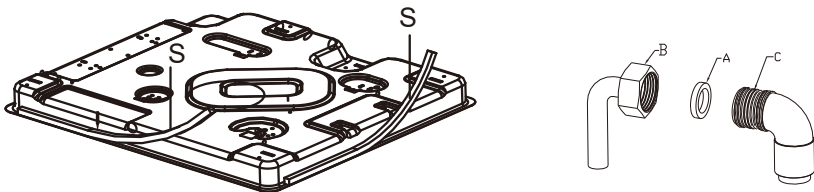

### Fastening the Cooktop to the Bench

- Gently lower the cooktop into the cutout ensuring you have access below the countertop to fit and secure the brackets.
- Locate the brackets to the appropriate slots on the cooktop chassis and tighten screws on all 4 locations to secure the cooktop to the countertop.
- Ensure cooktop is level.

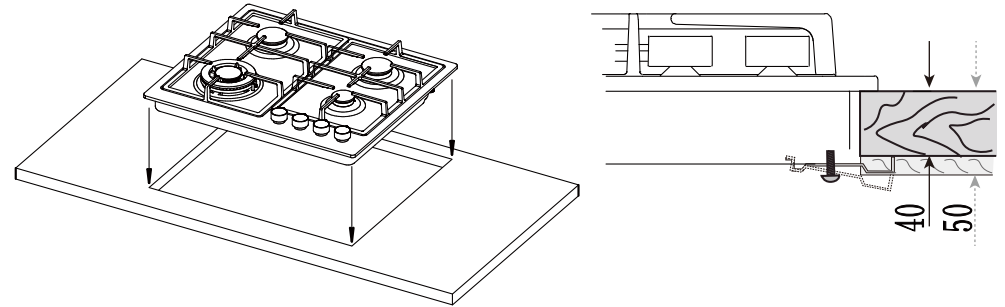

- For benches thinner than 40 mm, use a spacer to achieve benchtop recommended thickness.
- For benches thicker than 50 mm, recess the underside of the bench to achieve recommended thickness.

### Connecting the Cooktop to the Gas Supply

#### IMPORTANT!

- This cooktop is supplied factory-set for either Natural Gas or ULPG. Please ensure that the factory-set adjustment of the cooktop is compatible with the local distribution conditions (nature of gas and pressure).
- The gas connection must be carried out by a suitably qualified person according to the relevant standards.

#### Regulator/Adapters



Remove the dust seals on the inlet & outlet ports.

Ensure the supplied regulator/adapter is fitted in the correct orientation as shown above.

With all burners operating at the highest setting, adjust to obtain a test point pressure of:

- 1.0 kPa for Natural Gas (NG)
- 2.75 kPa for LPG

#### All model types

- Make sure the connection point will be accessible with the cooktop installed.
- To enable the gas supply to be readily shut off by the customer, make sure the connection is fitted with an isolating valve close to the cooktop.

If connecting the gas with a flexible hose:

- Ensure the hose is long enough to allow for removal of cooktop for servicing.
- Make sure the connector is located as shown in step 5 CLEARANCE DIMENSIONS.
- The hose assembly must be AS/NZS 1869 Class B or D certified, with an Rp ½" (ISO 7 - 1) female thread connection.
- The hose assembly must be as short as practicable and comply with relevant AS 5601/NZS 5261 requirements.
- The hose must not be kinked, subjected to abrasion or permanently deformed.
- The hose must not be near or in contact with any hot surfaces (e.g. base of metal hot plate, flue, or chassis of underbench oven etc.)

**Leak-Testing the Cooktop**

- Ensure all dials are set to OFF before connecting cooktop to gas supply.
- After final gas connection is made, turn gas supply on and test all connections in gas supply piping for gas leaks with a soapy water solution.

**IMPORTANT!**

- In order to avoid property damage or serious personal injury, never use a match or open flame. If a leak is present, tighten joint or unscrew, apply more joint compound, tighten again and retest connection for leak.

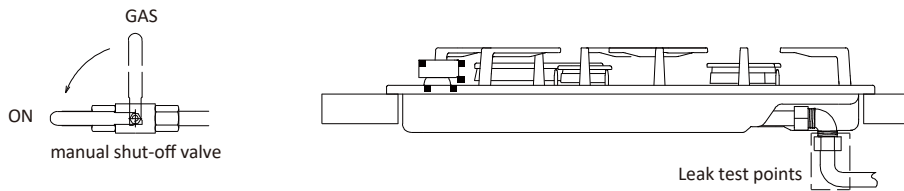

**Electrical connection, Attach pan supports, Test burners**

- 1) Connect the cooktop to the power supply and attach the duplicate data label to an accessible location.
- 2) Securely locate all pan supports ensuring they are installed in the correct orientation and do not rock.
- 3) **TEST BURNERS**
  - To check that the ignition system operates correctly, light each burner by itself, then all burners in combination.
  - Check for a well-defined blue flame without any yellow tipping.
  - If any abnormality is evident, check that the components of the burner assembly are located properly.
  - Incorrect installation may produce a potentially dangerous flame and result in poor burner performance.
  - If proper operation cannot be obtained, contact Customer Care or nearest authorized Service Centre.
  - The cooktop must not be used until proper operation has been achieved.

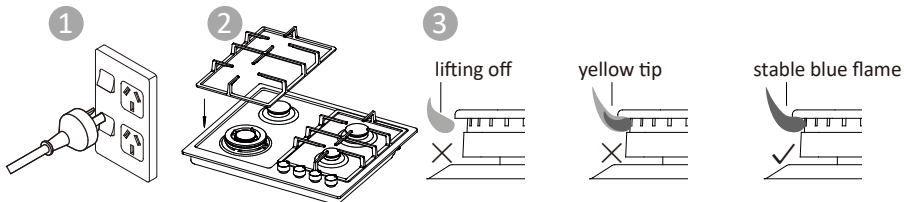

**Converting to a Different Gas Type**

All appliances are factory set for Natural gas but are convertible to LPG.

**IMPORTANT!**

Gas conversion may only be carried out by a suitably qualified and registered person. To convert from one gas type to another you will need to replace the injectors and adjust the minimum burner setting.

- Switch off the power supply and ensure the gas supply is shut off at the connection point from the wall.
- Remove all pan supports and burners
- Using a socket spanner "B" (7mm), unscrew injector "A" & replace with recommended injector (see table below for reference).
- Replace the burners, switch on the power at the wall and turn the gas supply on at the connection point.
- Light the burner and turn the dial to the minimum (low) setting.
- Pull off the dial gently, insert a small screwdriver "D" into the top shaft "C" and rotate the bypass screw left or right slowly until flame of the burner is conveniently regulated to the low setting.
- Replace the dial carefully. Ensure the dial is in the off position. Replace the pan supports.
- Check the regulation by quickly turning down the flame from maximum to the minimum setting – it must not go out. If the flame does go out, check the gas pressure has been correctly set and then re-adjust the minimum setting as described above.

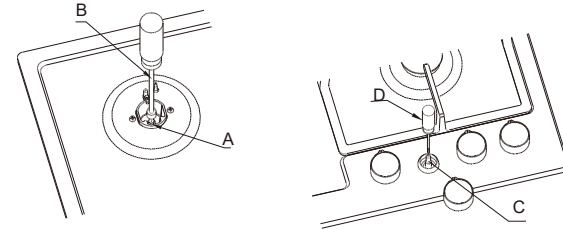

**Gas Rate and Injector Size Table**

	BURNERS DESCRIPTION	GAS	NORMAL RATE	INJECTOR DIAMETER	NOMINAL HEAT INPUT (MJ/h)
			MJ/h	mm	MIN.
1	AUXILIARY	2.75 Kpa Universal - LPG 1.0 Kpa natural gas	3.6 3.6	0.52 0.87	2.16 2.16
2	SEMIRAPID	2.75 Kpa Universal - LPG 1.0 Kpa natural gas	6.3 6.3	0.68 1.11	2.88 2.88
3	RAPID	2.75 Kpa Universal - LPG 1.0 Kpa natural gas	10.8 10.8	0.9 1.45	4.32 4.32
4	TRIPLE FLAME	2.75 Kpa Universal - LPG 1.0 Kpa natural gas	13.7 13.7	1.03 1.62	9.36 9.36

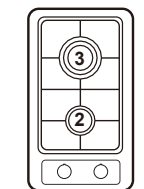
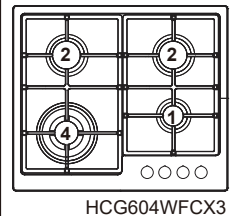

HCG302WFCX3

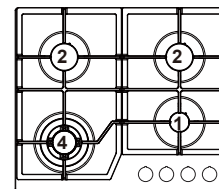

HCG604WFCG3

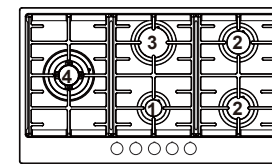

HCG905WFCX3

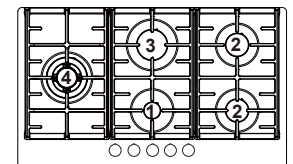

HCG905WFCG3

## PRODUCT OVERVIEW

Thank you for purchasing a Haier Gas Cooktop. All appliances are factory set for Natural gas but are convertible to LPG. See 'Converting to a different gas type' section for more details regarding the conversion instructions.

### Safety feature: Flame failure protection

Your cooktop is equipped with flame failure protection: the gas supply will automatically be cut off to a burner that is accidentally blown out by a draught or extinguished by a spill.

### Before using the cooktop for the first time

- Read this user guide, taking special notice of the 'Safety and Warnings' section.
- Check that the pan supports are all in place and stable, and the flame spreaders, burner caps and rings are all seated correctly.
- Ensure the power supply to the cooktop is turned on.

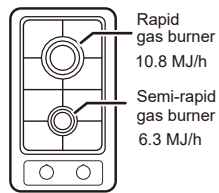

HCG302WFCX3

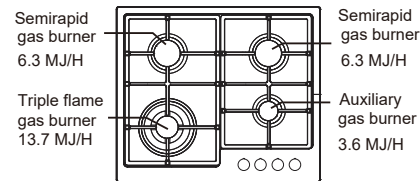

HCG604WFCX3

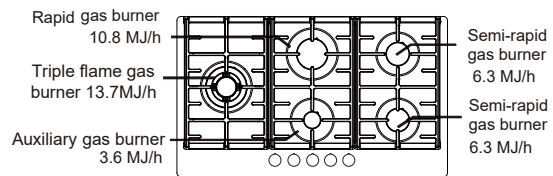

HCG905WFCG3

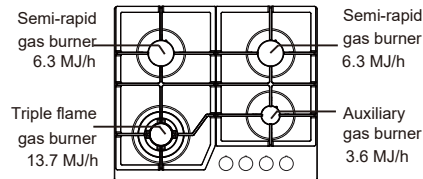

HCG604WFCG3

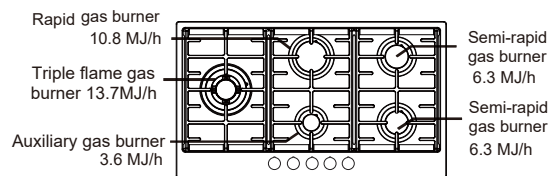

HCG905WFCX3

## USING YOUR COOKTOP

### Control Dials

The dials control the flow of gas through the valve.

### Using the Burners

- Press the selected burner's dial down gently and turn it anti-clockwise to HIGH. The ignitors on all the burners will spark.
- Hold down the dial for about 5 seconds after the burner has lit. Releasing the dial too soon will extinguish the flame.
- Adjust the flame anywhere between HIGH and LOW. Do not adjust between HIGH and O (OFF).
- After use, always turn the dials to O (OFF).

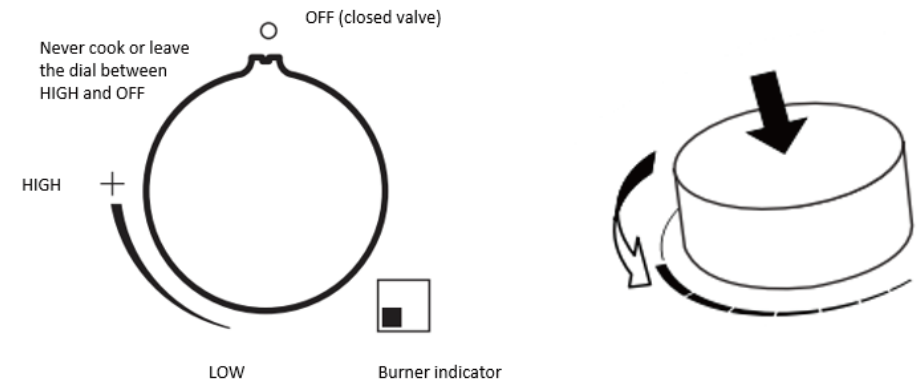

### IMPORTANT! If a burner does not light

Turn the control dial to O (OFF) and wait at least 1 minute before trying again. This is to allow the gas to disperse. If after trying again the burner still does not light, see relevant troubleshooting section.

### If there is a power failure

- You can still use your cooktop.
- Light the burners by holding a match close to the side of the burner and turning the control dial to HIGH. Wait until the flame is burning evenly before adjusting.

### If the flame is accidentally extinguished

- The flame failure protection will automatically cut the gas supply to the burner off. Turn the corresponding dial to O (OFF) and do not try to relight it for at least 1 minute (to allow the gas to disperse)

## COOKING GUIDELINES

### IMPORTANT!

- **Never leave the cooktop unattended when in use. Boil over causes smoking and greasy spills that may ignite.**
- **Take care when deep-frying: oil or fat can overheat very quickly, particularly on a high setting.**
- Using a lid will reduce cooking times through retaining the heat.
- Minimise the amount of liquid to reduce cooking times.

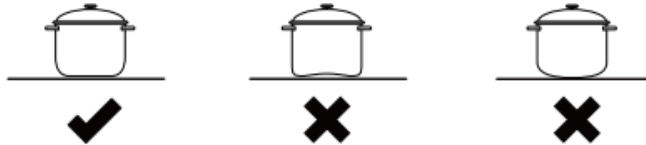

- Use saucepans with thick flat bases.
- Do not let large saucepans or frying pans overlap the bench, as this can deflect heat onto your benchtop and damage its surface.
- Always make sure saucepans are stable by centring them over the burner.
- Make sure the size of the pan matches the size of the burner. A small pot on a large burner is not efficient. A wider pot on a narrow pan support might be instable. The following table shows the **recommended** minimum and maximum saucepan base diameters that may be used on each burner:

BURNER	MIN DIAMETER	MAX DIAMETER
Auxiliary	10 cm	14 cm
Semi Rapid	16 cm	18 cm
Rapid	20 cm	22 cm
Triple Flame	24 cm	26 cm

## CARE & CLEANING

### IMPORTANT!

Before any cleaning or maintenance always:

- **Turn all burners off.**
- **Switch the power to the cooktop off at the wall.**
- **Make sure that the cooktop and its parts are a safe temperature to touch.**

### General advice

- Clean the cooktop regularly—do not let stains become burnt on, as they may become very difficult to remove.
- Do not use abrasive cleaners, cloths or pads to clean any part of your cooktop. Some nylon scourers may also scratch. Check the label.
- Clean up spillages as soon as possible. If left to dry on, food residue may clog the flame ports, causing an uneven flame pattern.
- Make sure that no cleaner residue is left on any cooktop part; when heated, these could stain the cooktop.
- Ensure the flame ports are clear and ignitors are clean. You can use a toothbrush carefully for cleaning.
- Do not clean cooktop parts in a self-cleaning oven.
- Do not use a steam cleaner

### Replacing the pan supports

- Place the pan supports ensuring they're aligned and centred with respect to burners.
- For models HCG905WFCX3 & HCG905WFCG3, centre & right pan supports are identical and thus interchangeable.

### Replacing the burner parts

- Ensure that all burner parts are correctly fitted. Incorrectly assembled burners may produce dangerous flames. Flames should be blue with no yellow tipping, and burn without fluttering around the burner cap.

## TROUBLESHOOTING

PROBLEM	POSSIBLE CAUSES	WHAT TO DO
<b>There is a strong gas smell</b>	The gas connection could be leaking.	Open a window and refer to your installation guide for details on checking for leaks. Do not use until the leak has been repaired.
<b>There is a slight rubbery or metallic smell when I use the cooktop for the first time</b>	This is normal for first use and is caused by manufacturing residues burning off.	The smell will disappear with use.
<b>There is no clicking/sparking</b>	There is a power failure.	You can still use your cooktop, but will need to match-light the burners.
	The ignitor may be dirty or wet.	Clean following guidance in 'Care and cleaning'.
<b>There is clicking/sparking, but a burner or burners won't light easily or at all</b>	The gas supply may not be turned on at the valve or gas bottle.	Turn all the burners off, and check whether the gas supply to the cooktop is turned on. Wait 1 minute, then try relighting the burner, holding the dial down for a few more seconds. If the burner still doesn't light, check other possible causes below.
	The gas supply to the house may not be working.	You should hear the gas when you turn a burner on. If you use bottled gas, this may indicate you are getting near the end of the bottle and need to replace it.
	Burner parts may be clogged or wet. Burner parts may not have been replaced correctly.	Ensure parts are clean and dry. See 'Care and cleaning' for guidance. Check the assembly and ensure the burner cap is sitting flat.
<b>The burner goes out after lighting</b>	Dial not held down long enough	Wait 1 minute, then try relighting the burner, holding the dial down for a few more seconds.
<b>The flame has been extinguished</b>	Blown out by draught	The flame failure protection will automatically cut the gas supply to the burner off, stopping gas from escaping.
	Extinguished by a spill	Turn the affected burner off, then wait for at least 1 minute before attempting to relight. This is to allow for any accumulated gas to disperse.

<b>The flame goes out at low settings</b>	The gas supply pressure may be low.	Check this with your service person or installer.
<b>The flames are yellow or yellow-tipped rather than blue</b>	Burner parts (especially the flame ports) may be clogged or wet.	Check that they are clean and dry, refer to 'Care and cleaning' for advice.
	The cooktop may have been connected to the wrong type of gas or the gas pressure is not correct.	Contact Customer Care and do not use your cooktop until it has been checked by a trained and supported service technician.
<b>The flame pattern is uneven around the burner.</b>	Burner parts (especially the flame ports) may be clogged or wet.	Check that they are clean and dry. Refer to 'Care and cleaning' for advice.
	Burner parts may not have been replaced correctly.	Check the assembly and ensure the burner cap and/or ring is sitting flat on the flame spreader.
<b>The flames are too large, or too small.</b>	The cooktop may have been connected to the wrong type of gas.	Contact Customer Care and do not use your cooktop until it has been checked by a qualified technician.
<b>The flames are noisy.</b>		
<b>The flames lift away from the burner.</b>		
<b>The glass surface of the cooktop has chipped or cracked. (*)</b>		Contact Customer Care and do not use your cooktop until it has been repaired.

(\*) For HCG905WFCG3& HCG604WFCG3 only

## TECHNICAL SPECS

Type	Triple flame gas burner	Rapid gas burner	Semirapid gas burner	Auxiliary gas burner	Material	Flame failure device	Rated Electric Input	Power Supply
HCG302WFCX3	/	10.8 MJ/H	6.3 MJ/H	/	Stainless steel	Yes	1.1W	220-240V~50Hz
HCG604WFCX3	13.7 MJ/H	/	6.3 MJ/H	3.6 MJ/H	Stainless steel		1.1W	
HCG604WFCG3	13.7 MJ/H	/	6.3 MJ/H	3.6 MJ/H	Glass		1.1W	
HCG905WFCX3	13.7 MJ/H	10.8 MJ/H	6.3 MJ/H	3.6 MJ/H	Stainless steel		2.0W	
HCG905WFCG3	13.7 MJ/H	10.8 MJ/H	6.3 MJ/H	3.6 MJ/H	Glass		2.0W	

## MANUFACTURER'S WARRANTY

Please read this warranty card carefully. Attach your purchase receipt to this warranty card and keep in a safe place. You must produce both warranty card and proof of purchase in the event of a warranty repair being required.

When you purchase any new Haier Product you automatically receive a two year Manufacturer's Warranty covering parts and labour for servicing.

### The Manufacturer undertakes to:

Repair or, at its option, replace without cost to the owner either for material or labour any part of the Product, the serial number of which appears on the Product, which is found to be defective within TWO YEARS from the date of purchase.

### This warranty DOES NOT cover:

**A** Service calls which are not related to any defect in the Product. The cost of a service call will be charged if the problem is not found to be a Product related fault. For example:

1. Correct the installation of the product.
2. Provide Instruction on use of the product or change the setup of the product.
3. Replace house fuses or correct house wiring.
4. Correcting fault(s) caused by the user.
5. Noise or vibration that is considered normal.
6. Water on the floor due to incorrect loading or excessive suds.
7. Blocked pumps, removal of foreign objects/substances from the machine, including the pump and inlet house filters.
8. Correcting damage caused by pests, eg. rats, cockroaches etc.
9. Correct corrosion or discolouration due to chemical attack.
10. Power outages or surges.

**B** Defects caused by factors other than:

1. Normal domestic use or
2. Use in accordance with the Product's User Guide.

**C** Defects to the Product caused by accident, neglect, misuse or 'Act of God'.

**D** The cost of repairs carried out by non-authorized repairers or the cost of correcting such unauthorised repairs.

**E** Normal recommended maintenance as set out in the Product's User Guide.

**F** Repairs when the appliance has been dismantled, repaired or serviced by other than an AUTHORISED CUSTOMER SERVICE CENTRE or the selling dealer.

**G** Pick up and delivery.

**H** Transportation or travelling costs involved in the repair when the product is installed outside the AUTHORISED CUSTOMER SERVICE CENTRE'S normal service area.

This product has been designed for use in a normal domestic environment. It is not intended for commercial use. Doing so may affect product warranty. Service under this warranty must be provided by an Authorised Service Repairer (refer to the Customer Care section for contact details). Such service shall be provided during normal business hours. This warranty certificate should be shown when making any claim.

### Note:

This Warranty is an extra benefit and does not affect your legal rights and applies only to product purchased in New Zealand and Australia. Please keep this Warranty Card in a safe place.

### For Australian customers:

Our goods come with guarantees that cannot be excluded under the Australian Consumer Law. You are entitled to a replacement or refund for a major failure and for compensation for any other reasonably foreseeable loss

or damage. You are also entitled to have the goods repaired or replaced if the goods fail to be of acceptable quality and the failure does not amount to a major failure.

## CUSTOMER CARE

---

Check the things you can do yourself.

Refer to your User Guide and check:

- 1 Your appliance is correctly installed.
- 2 You are familiar with its normal operation.
- 3 You have read the problem solving section in your User Guide.

If after checking these points you still need assistance, please refer to your nearest Haier Authorised Repairer.

### **In New Zealand, if you need assistance...\***

Call your retailer who is trained to provide information on your appliance, or if we can be of any further help, please contact our Customer Care Centre:

Toll Free: 0800 372 273 Fax: (09) 273 0656

Email: [customer.care@haier.co.nz](mailto:customer.care@haier.co.nz)

Postal address: P.O. Box 58732, Botany, Manukau 2163

### **If you need service...\***

We have a network of independent Fisher & Paykel Authorised Repairers whose fully trained technicians can carry out any service necessary on your appliance.

Your dealer or our Customer Care Centre can recommend a Fisher & Paykel Authorised Repairer in your area.

### **In Australia, if you need assistance...\***

Call the Customer Care Centre and talk to one of our Customer Care Consultants.

Toll Free: 1300 729 948 Fax: (07) 3826 9298

Email: [customer.care@haierlife.com.au](mailto:customer.care@haierlife.com.au)

Postal Address: PO Box 798, Cleveland QLD 4163

### **If you need service...\***

We have a network of qualified Authorised Repairers whose fully trained technicians can carry out any service necessary on your appliance. Our Customer Care Centre can recommend an Authorised Repairer in your area.

\*If you call or write, please provide: name, address, model number, serial number, date of purchase and a description of the problem. This information is needed in order to better respond to your request for assistance.

Product Details

Model ----- Serial No. -----  
Date of Purchase----- Purchaser-----  
Dealer----- Suburb-----  
Town----- Country-----

Thank you for choosing Haier. We are confident that you will enjoy many years of good service from your appliance.