

**Veise**

# *Installation Manual*

Model No. **VE017**



**Tutorial Video**

Scan the QR code and search **VE017** to get the video.

## **Need Help? Contact Us!**

Call us at **+1(855)400-3853** ( Monday-Friday 9:00am-5:00pm PST ), if you have any questions.

✉ [support@iveise.com](mailto:support@iveise.com) 🌐 [iveise.com](http://iveise.com)







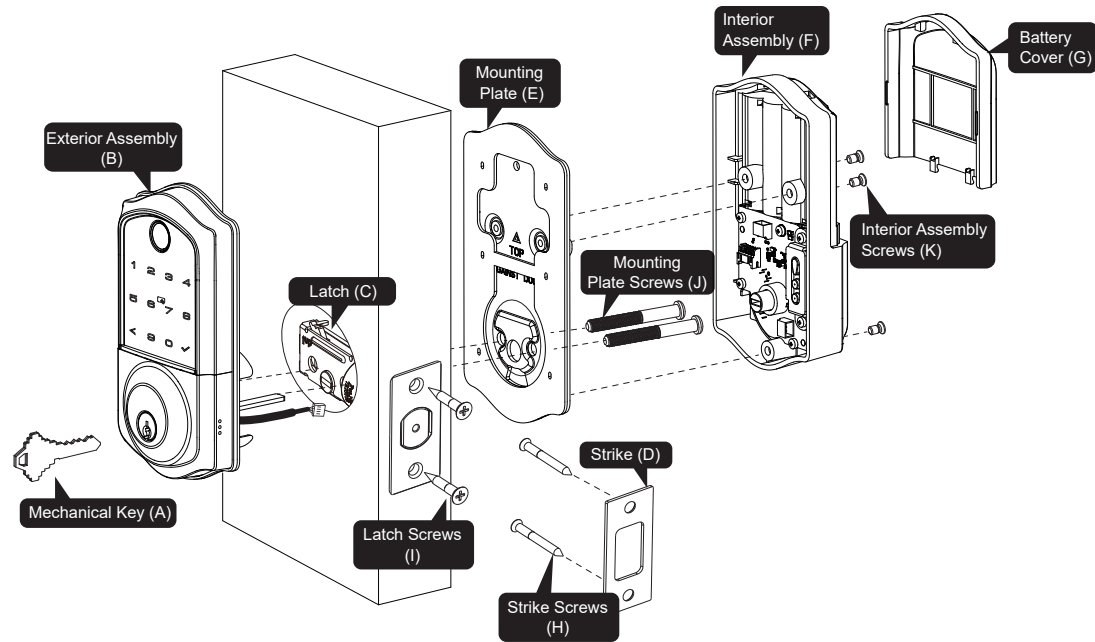

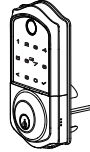
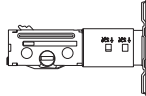

## » Content

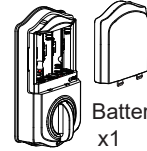
• Parts List	01
• Installation Guide	02
Step 1: Prepare the Door & Check Dimensions	02
Step 2: Install the Latch & Strike	05
Step 3: Install Exterior Assembly	08
Step 4: Install Interior Assembly	10
• How to Reset	12
• Troubleshooting	13

## Installation Overview

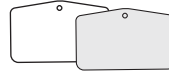

## Parts List

<p><b>A</b> Mechanical Key x2</p> 	<p><b>B</b> Exterior Assembly x1</p> 	<p><b>C</b> Latch x1</p> 	<p><b>D</b> Strike x1</p> 
<p><b>E</b> Mounting Plate x1</p> 	<p><b>F</b> Interior Assembly x1</p>  <p><b>G</b> Battery Cover x1</p> 	<p><b>H</b> Strike Screws x2</p> 	<p><b>I</b> Latch Screws x2</p> 
<p><b>J</b> Mounting Plate Screws x2</p> 	<p><b>K</b> Interior Assembly Screws x5 (2 Spare)</p>  <p><b>L</b> Reset Tool x1</p> 	<p><b>M</b> Drive-In Collar (Optional)</p> 	<p><b>N</b> User Card x2</p> 

⚠ Missing any parts? Call us at [+1\(855\)400-3853](tel:+18554003853). ✉ [support@iveise.com](mailto:support@iveise.com) 01



## Installation Guide

### ► Step 1: Prepare the Door & Check Dimensions

1

The hole in the door is 1-1/2" or 2-1/8" (38mm or 54mm).

The hole in the door edge is 1" (25mm).

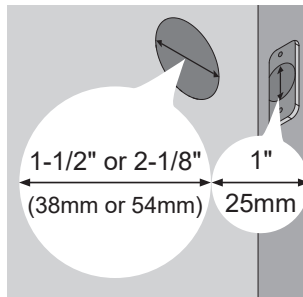

2

The backset is either 2-3/8" or 2-3/4" (60mm or 70mm).

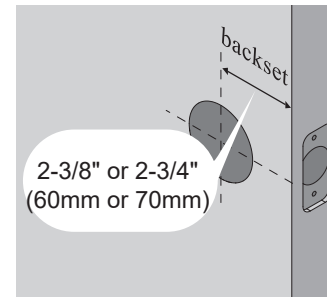

3

The door thickness is 1-3/8" to 2" (35mm to 50mm).

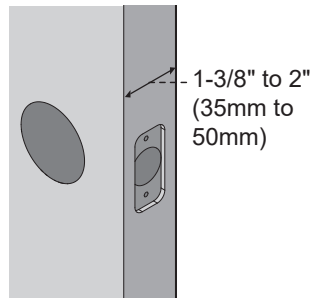

4

**NOTE:**

Make sure the door frame is aligned with the door.

There are no obstructions stuck in the door frame.

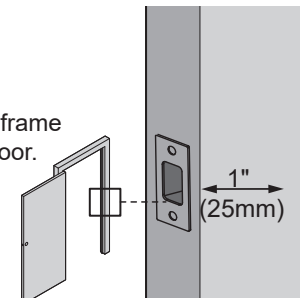



## Installation Guide

### ▶ Step 1: Prepare the Door & Check Dimensions

#### Optional: Instructions for doors with 1-1/2" (38mm) holes

##### 1. Test whether you need to extend the Latch hole.

Temporarily install the Latch bolt.

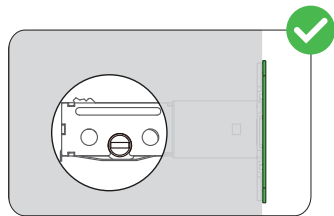

Fit properly

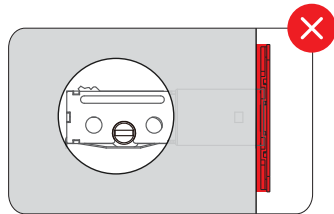

Fit improperly

If the Latch bolt is stuck, you need to extend the Latch hole.

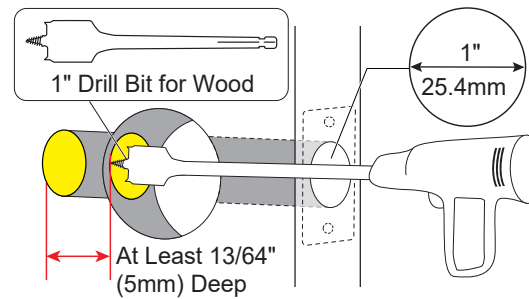

Extend the Latch hole at least 13/64" (5mm) deep by using a 1" (25.4mm) Drill Bit.



## Installation Guide

### ▶ Step 1: Prepare the Door & Check Dimensions

#### 2. Test the extended Latch hole.

Temporarily install the Latch bolt, rotate it with a screwdriver to test if it extends and retracts properly.

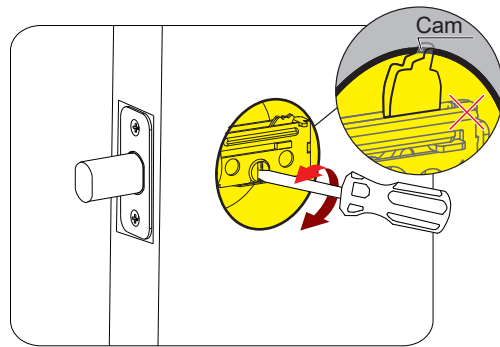

04

If the Latch bolt is stuck, remove the Latch bolt and chisel out a small channel at the top of the hole to give the Cam room to rotate.

(Refer to the following image)

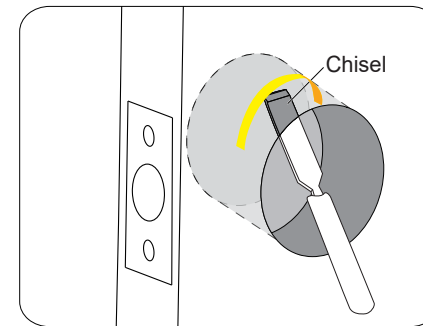



## Installation Guide

### ▶ Step 2: Install the Latch & Strike

- 1 Confirm the backset and adjust the Latch.

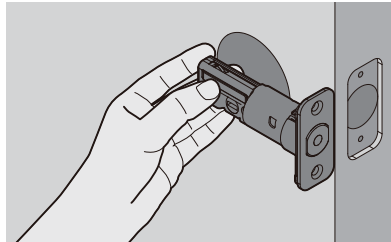

Hold the Latch in front of the door hole,  
flush the Latch against the door edge.  
Is the slotted hole centred in the door hole?

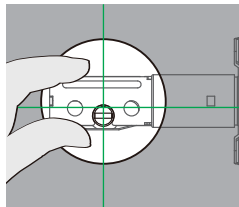

**YES**

No need to adjust.

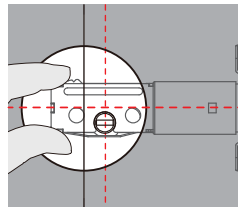

**NO** →

Slotted hole is NOT  
centred.

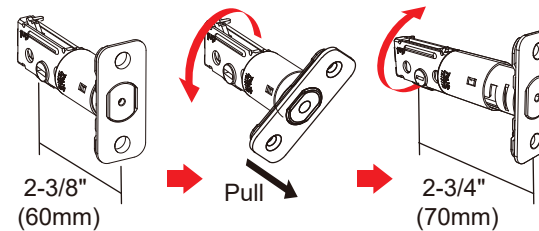

Rotate and pull the Latch as shown to extend the  
Latch.



## Installation Guide

### ▶ Step 2: Install the Latch & Strike

**2** Install the Latch.

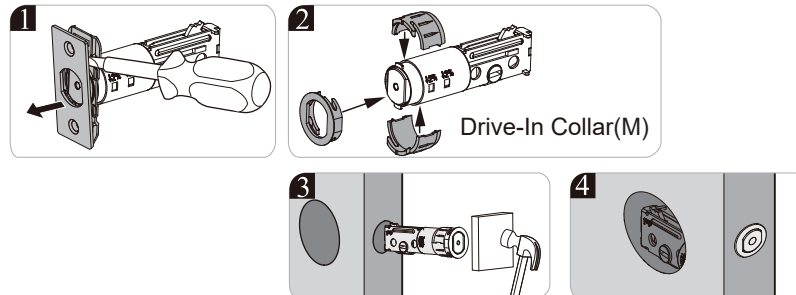
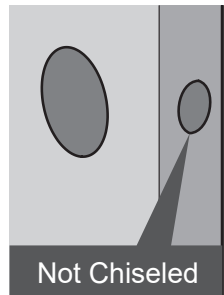
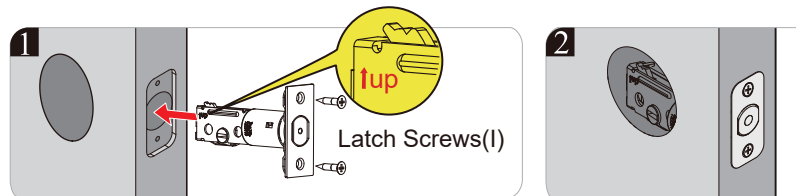

06



## Installation Guide

### ▶ Step 2: Install the Latch & Strike

- 3** Test if the Latch bolt extends and retracts properly by using a screwdriver.

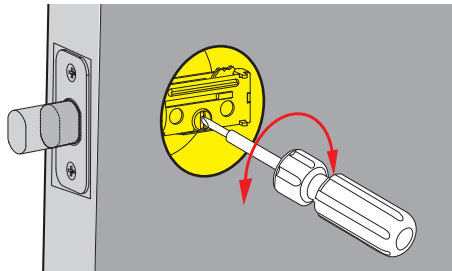

**⚠ Important:**

Before installation, the Latch bolt should be retracted completely (in the unlocked position).



- 4** Install Strike on the door frame.

**⚠ Important:**

Make sure the hole in door frame is drilled a minimum of 1" (25mm) deep.

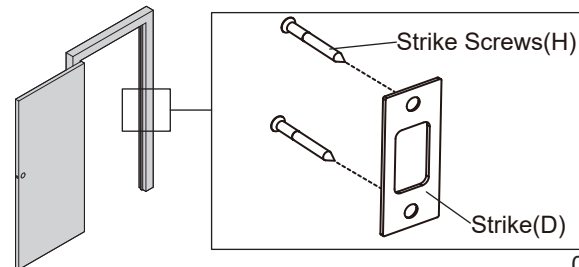



## Installation Guide

### ▶ Step 3: Install Exterior Assembly

- 1 Measure the diameter of the hole in the door.

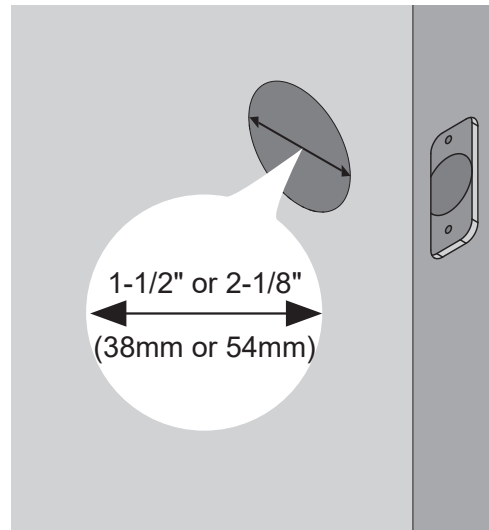

**2-1/8" (54mm)**  
Go to next step directly.

**1-1/2" (38mm)**  
Remove the spacer on the exterior assembly.

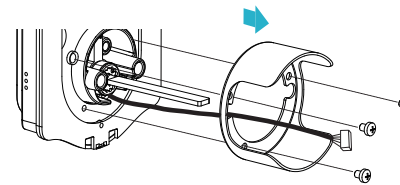



## Installation Guide

### ▶ Step 3: Install Exterior Assembly

- 2** Route the cable below the Latch and insert the Torque Blade horizontally into the Latch slot, ensuring both the blade and slot are level.

Do not insert the Mechanical Key into the cylinder during the installation.

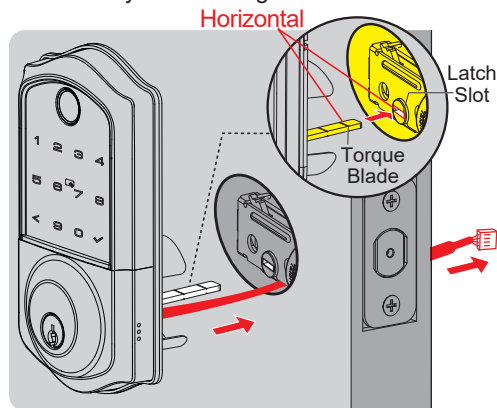

- 3** Install the Mounting Plate with the Mounting Plate Screws.

Do not overtighten screws.

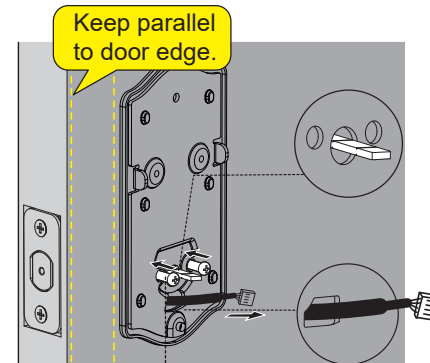



## Installation Guide

### ▶ Step 4: Install Interior Assembly

- 1** Disassemble the Battery Cover.

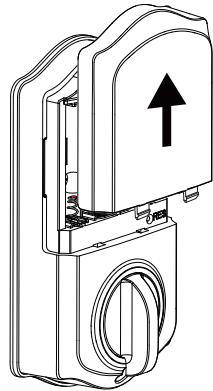

**⚠ Important:**

Do not load batteries until the lock is completely installed.

- 2** Insert the cable connector into the socket. Push the connector in firmly until it is completely attached.

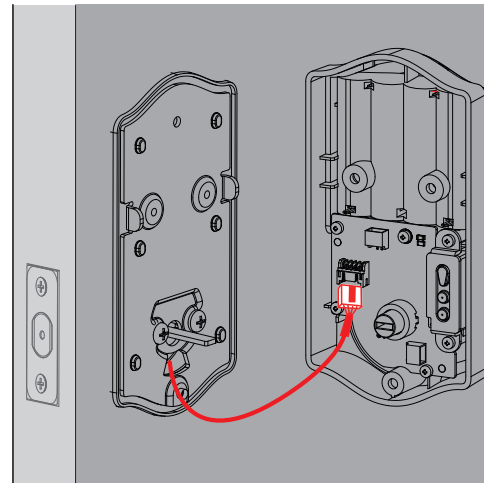



## Installation Guide

### ▶ Step 4: Install Interior Assembly

- 3** Attach Interior Assembly to Mounting Plate and tighten 3 screws.

**NOTE:**

Be sure not to use the wrong screws, or it may lead to short-circuit and other problems.

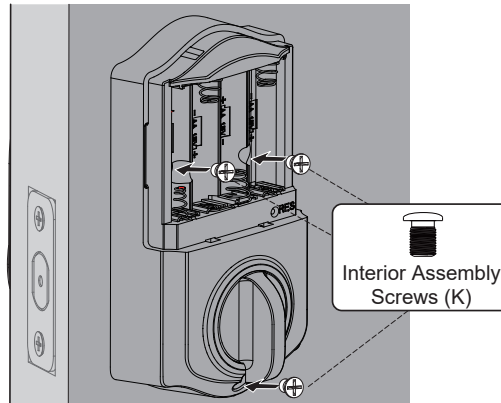

- 4** Insert 4 AA Alkaline batteries and put on the Battery Cover.

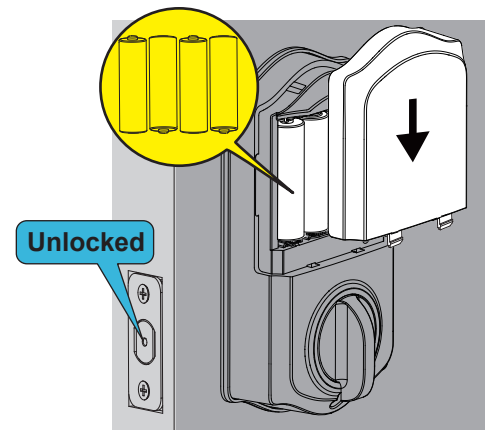

## How to Reset

- 1** Keep the door open and unlocked.
- 2** Press and hold the Reset Button for 5 seconds by using the Reset Tool.
- 3** Keep holding the Reset Button until you hear a long sound of beep and the Latch bolt extends out automatically.

Settings	Factory Default
Master Code	12345678
Auto Lock	Disabled
Silent Mode	Disabled
Wrong Entry Limit	10 times
Shutdown Time	3 mins
Vacation Mode	Disabled



Scan the QR code

Search **VE017**

Call us at **+1(855)400-3853**,  
if you have any questions.

 [support@iveise.com](mailto:support@iveise.com)  [iveise.com](http://iveise.com)

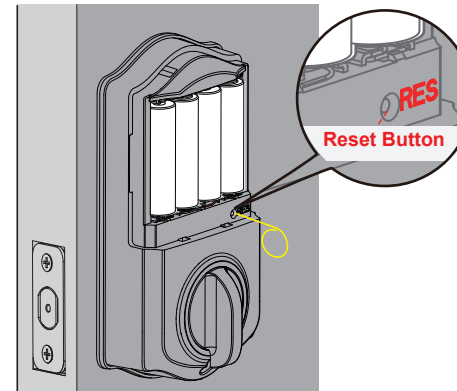



## Troubleshooting

### ▶ The Latch bolt keeps going in and out.

Disassemble and reinstall the lock by following the installation tips.

1. Please don't insert the Mechanical Key into the lock cylinder before or during installation.
2. Keep the Latch fully retracted and the Torque Blade horizontal.
3. Please make sure to route the cable below the Latch.
4. The Exterior and Interior Assembly should be installed parallel to the door edge.

### ▶ I cannot remove my key unless it is in the locked position.

Uninstall the Interior and Exterior Assemblies. Before re-installation, please follow these guidelines:

1. Make sure the Latch bolt is in the retracted position.
2. Do not insert the Mechanical Key into the lock cylinder before or during installation.
3. Make sure the Torque Blade is inserted horizontally.

### ▶ Fail to reset.

1. The battery is low if the battery indicator light keeps flashing. Please replace it with 4 new batteries. (Alkaline batteries only)
2. Please refer to “**How to Reset**” section and perform a resetting again.



## Troubleshooting

### ▶ How to lock manually on the Keypad from outside?

1. Touch  once.
2. Press and hold any button for 2 seconds.
3. Use your Fingerprint.

### ▶ The Latch bolt won't be extended out completely after installation.

Please review if the Exterior Assembly is aligned parallel to the door edge. The Exterior Assembly should not be at a crooked angle.

If you have any questions, please contact us at **+1(855)400-3853**.

 **support@iveise.com**

## » FCC Caution

This device complies with part 15 of the FCC Rules. Operation is subject to the following two conditions:

- (1) This device may not cause harmful interference.
- (2) this device must accept any interference received, including interference that may cause undesired operation.

Any Changes or modifications not expressly approved by the party responsible for compliance could void the user's authority to operate the equipment.

Note: This equipment has been tested and found to comply with the limits for a Class B digital device, pursuant to part 15 of the FCC Rules. These limits are designed to provide reasonable protection against harmful interference in a residential installation. This equipment generates uses and can radiate radio frequency energy and, if not installed and used in accordance with the instructions, may cause harmful interference to radio communications. However, there is no guarantee that interference will not occur in a particular installation. If this equipment does cause harmful interference to radio or television reception, which can be determined by turning the equipment off and on, the user is encouraged to try to correct the interference by one or more of the following measures:

- Reorient or relocate the receiving antenna.
- Increase the separation between the equipment and receiver.
- Connect the equipment into an outlet on a circuit different from that to which the receiver is connected.
- Consult the dealer or an experienced radio/TV technician for help.

### FCC Radiation Exposure Statement

This equipment complies with FCC radiation exposure limits set forth for an uncontrolled environment. This equipment should be installed and operated with minimum distance 20cm between the radiator & your body.

## » IC Warning

This device complies with Industry Canada's licence-exempt RSSs.

Operation is subject to the following two conditions:

(1) This device may not cause interference.

(2) This device must accept any interference, including interference that may cause undesired operation of the device.

This equipment complies with IC radiation exposure limits set forth for an uncontrolled environment. This equipment should be installed and operated with minimum distance 20cm between the radiator & your body.

Cet appareil est conforme aux CNR exemptes de licence d'Industrie Canada .

Son fonctionnement est soumis aux deux conditions suivantes :

( 1 ) Ce dispositif ne peut causer d'interférences ; et

( 2 ) Ce dispositif doit accepter toute interférence , y compris les interférences qui peuvent causer un mauvais fonctionnement de l'appareil.

Ce matériel est complété par une exposition de rayonnements IC pour un environnement naturel. Ce matériel doit être installé et se faire avec une distance minimale de 20cm entre les radiateurs et les autresYour body shop.

## » Information & Safety Warnings

- Protect your User Codes and Master Code.
- Restrict access to your lock's Interior Assembly and routinely check your settings to ensure they have not been altered without your knowledge.
- Do not use an electric screwdriver during installation.
- This manufacturer advises that no lock can provide complete security by itself.
- This lock may be defeated by forcible or technical means, or evaded by entry elsewhere on the property.
- No lock can substitute for caution, awareness of your environment, and common sense.
- Take care to ensure a long-lasting finish. Please use soft and damp cloth to clean the lockset if you need. Using lacquer thinner, caustic soaps, abrasive cleaners or polishes could damage the coating and result in tarnishing.
- The lock is water-resistant. It can withstand water splashes; however, do not let water and liquids get into the lock.
- Avoid exposure to direct sunlight. Long-term exposure to direct sunlight may damage the lock.

# Need Help? Contact Us!

If you have any questions, please contact us at

 **+1(855)400-3853**

(Monday-Friday 9:00am-5:00pm PST)

 **support@iveise.com**  **iveise.com**

If you have your **order ID, videos or images of your problem** (if necessary) ready before contacting Customer Support, we will solve your problem faster and better.

V8.0