

CBS-1221 Plus Air Pot Brewer
FETCO Commercial Beverage Equipment



CBS-1221 Air Pot Brewer, shown with 2.2 liter Air Pot (sold separately)



CONTACT INFORMATION

FETCO® FOOD EQUIPMENT TECHNOLOGIES COMPANY
600 ROSE ROAD
LAKE ZURICH • IL • 60047-0429 • USA
INTERNET: www.fetco.com



©2020-2021 FOOD EQUIPMENT TECHNOLOGIES COMPANY
PATENTS: <https://www.fetco.com/pl/pages/patents,74.html>

PHONE: (800) 338-2699 (US & CANADA)
(847) 719-3000 (All Countries)
FAX: (847) 719-3001
EMAIL: sales@fetco.com
orders@fetco.com (to order parts and equipment)
techsupport@fetco.com (all service queries)
P194 REV. 002 February 2023

Coffee Brewer: CBS-1221

TABLE OF CONTENTS

Specifications and Requirements	2	F SERVICE MENU	9
Starting The Brew	4	F Error Codes	10
Enter Programming	4	G COUNTERS	11
Exit Programming & Save	4	H SAVE & EXIT	11
A PROGRAM	6	Operator Training	12
B GENERAL	7	Small Spray Head Assembly	16
C SERVICE INPUTS	8	Parts Diagrams	17
D SERVICE OUTPUTS	8	Wiring Diagram	23
E CALIBRATION	8		

Specifications and Requirements

Water Requirements:

CBS-1221: 20-75 psig, (138-517kPa) 1½gpm/(5.7lpm)
 Water supplied to hot beverage equipment should be filtered
Water inlet fitting is a 1/4 inch male flare.

Brew Volume: First Batch 2.20 liters

Brew Volume: Second Batch 1.90 liters

Third batch is vacant by factory, ready to program by user

User adjustable to up to 0.85 gallon/3.25 liters per brew

Total Brew Cycle—First batch factory default setting: 5 minutes=[3.5 minute brew time + 1.5 minute drip delay]

Second batch factory default setting: 4.5 minutes=[3.0 minute brew time + 1.5 minute drip delay]

Brew-Process parameters are user controllable for:

Brew Volume, Brew Time, Prewet Percent and Prewet Delay, Drip Delay

Electrical: Supplied with cord & plug

User adjustable to 220-240 volt terminal block

Tank Temperature, as set by factory:

200°F (93°C) inside water tank (at sea level)

Water supply: (Optimal) 100-150TDS

All beverage equipment must use filtered water.

Brew basket filters: Large 13" x 5" or F002

Small basket 10-5/8" x 4-1/2" or F008

Weights and Capacities





Dispenser Model	Height	Width	Depth	Water tank capacity	Empty Weight	Filled Weight	Shipping Weight	Shipping Dimensions
CBS-1221 Brewer	26 in 660 mm	9 1/4 in 240 mm	22 1/4 in 560 mm	2.7 gallon 10.1 L	29bs. 13.1 kg	52 lbs. 23.6 kg	35 lbs. 15.9 kg	31½" x 24¾" x 13" 800mmX629X330mm

Calibrated for
2.2 L/74 oz/0.58gal air pot







Calibrated for 120g/4.2oz coffee dose
 Range: 100-140 gram 3.5-4 ounce dose
 (Dose size varies for brew basket size)

Coffee Filter
 FETCO# F008 or 10⅝" X 4½" (Standard)
 FETCO# F002 or 13" X 5" (Gourmet)

CBS-1221 brewbaskets

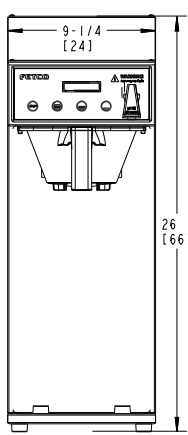
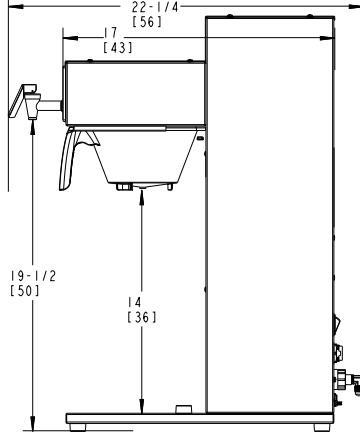
			
Brew basket LM Large metal 13"x5" F002 or 13"x5 filter paper	Brew basket LP Large metal 13"x5" F002 or 13"x5 filter paper	Brew basket SM Small metal 10⅝"x4½" F008 or 10⅝"x4½" filter paper	Brew basket SP Small plastic 10⅝"x4½" F008 or 10⅝"x4½" filter paper

Rough-In Drawings

		 <p style="text-align: center;">CBS-1221 Front</p>	 <p style="text-align: center;">CBS-1221 Side</p>
			
			
Domestic	International		

SKU NUMBER IDENTIFICATION KEY

Product Line	Level	Family	Region ID	Phase	Voltage Range	# Heaters	Individual Heater Wattage	Brew Basket	Hot Water Faucet	Bypass	Brew Basket Locks	Power Cord
E	1 2	2 1	C E	1	A	1	1 5	P	M	0	0	1
E=extractor	12=PLUS Series	21= single side	US =United States	1	A = 100-120	1	1.5	L=large metal	M=manual	1=Yes	1=Yes	0=Terminal Block
			IN = International	2	B = 200-240	2	1.7	M=small metal	A=automatic	0=no	0=no	1= NEMA 5-15P
			CE = CE	3	C = 380-415	3	2.3	K=large plastic	N=None			2=NEMA 5-20P
			NM = NOM	U = 1 or 3	D = 440-480		3.0	P=small plastic				3=NEMA 6-15P
							4.0					4=NEMA 6-30P
					X=120 or 240 Dual Voltage		5.0					5=CEE 7/7 Schuko
												6=UK1-13P
												7= AUSTRALIAN

FETCO CBS-1221 Plus Series 2.2 Liter Airpot Brewer

Electrical Specifications for Domestic-dual voltage

SKU Model description	Electrical Connection	Brew Basket	Heater Configuration	Voltage	KW	Amp Draw	Brew-Volume/Hour
E1221US-1X117-LM001 Domestic-Dual Voltage	NEMA 15-5P Terminal Block	LM	1 X 1.7 kW 1 X 3.0 kW	100-120	1.3-1.8	12.3-14.7	4.4 gal/16.5 liters
				200-240	2.2-3.1	10.9-13.0	6-7 gal/22-21 liters
E1221US-1X117-KM001 Domestic-Dual Voltage	NEMA 15-5P Terminal Block	LP	1 X 1.7 kW 1 X 3.0 kW	100-120	1.3-1.8	12.3-14.7	4.4 gal/16.5 liters
				200-240	2.2-3.1	10.9-13.0	6-7 gal/22-21 liters
E1221US-1X117-MM001 Domestic-Dual Voltage	NEMA 15-5P Terminal Block	SM	1 X 1.7 kW 1 X 3.0 kW	100-120	1.3-1.8	12.3-14.7	4.4 gal/16.5 liters
				200-240	2.2-3.1	10.9-13.0	6-7 gal/22-21 liters
E1221US-1X117-PM001 Domestic-Dual Voltage	NEMA 15-5P Terminal Block	SP	1 X 1.7 kW 1 X 3.0 kW	100-120	1.3-1.8	12.3-14.7	4.4 gal/16.5 liters
				200-240	2.2-3.1	10.9-13.0	6-7 gal/22-21 liters

Universal wiring, sold with 120 volt cord and plug. Brewers may be field converted to 200-240 volts-see page 15

Electrical Specifications, Domestic-single voltage 120 volt cord and plug

SKU	Electrical Connection	Brew Basket	Heater Configuration	Voltage	KW	Amp Draw	Brew-Volume/Hour
E1221US-1A117--LM001	NEMA 15-5P	LM	1 X 1.7 kW	100-120	1.3-1.8	12.3-14.7	4.4 gal/16.5 liters
E1221US-1A117-KM001	NEMA 15-5P	LP	1 X 1.7 kW	100-120	1.3-1.8	12.3-14.7	4.4 gal/16.5 liters
E1221US-1A117-MM001	NEMA 15-5P	SM	1 X 1.7 kW	100-120	1.3-1.8	12.3-14.7	4.4 gal/16.5 liters
E1221US-1A117-PM001	NEMA 15-5P	SP	1 X 1.7 kW	100-120	1.3-1.8	12.3-14.7	4.4 gal/16.5 liters

Electrical Specifications for International equipment Schuko cord and plug Note: All equipment operates either 50Hz or 60Hz

SKU	Electrical Connection	Brew Basket	Heater Configuration	Voltage	KW	Amp Draw	Brew-Volume/Hour
E1221IN-1B130--LM005 International-Schuko	Schuko plug CEE 7-7	LM	1 X 3.0 kW	230	2.8	12.4	7 gal/21 liters
				200-240	2.2-3.1	10.9-13.0	6-7 gal/22-21 liters
E1221IN-1B130-KM005 International-Schuko	Schuko plug CEE 7-7	LP	1 X 3.0 kW	230	2.8	12.4	7 gal/21 liters
				200-240	2.2-3.1	10.9-13.0	6-7 gal/22-21 liters
E1221IN-1B130-MM005 International-Schuko	Schuko plug CEE 7-7	SM	1 X 3.0 kW	230	2.8	12.4	7 gal/21 liters
				200-240	2.2-3.1	10.9-13.0	6-7 gal/22-21 liters
E1221IN-1B130-PM005 International-Schuko	Schuko plug CEE 7-7	SP	1 X 3.0 kW	230	2.8	12.4	7 gal/21 liters
				200-240	2.2-3.1	10.9-13.0	6-7 gal/22-21 liters

Electrical Specifications for International equipment UK cord and plug Note: All equipment operates either 50Hz or 60Hz

SKU	Electrical Connection	Brew Basket	Heater Configuration	Voltage	KW	Amp Draw	Brew-Volume/Hour
E1221IN-1B130-LM006 International-UK Plug	UK Plug TypG BS 1363 A	LM	1 X 3.0 kW	230	2.8	12.4	7 gal/21 liters
				200-240	2.2-3.1	10.9-13.0	6-7 gal/22-21 liters
E1221IN-1B130-KM006 International-UK Plug	UK Plug TypG BS 1363 A	LP	1 X 3.0 kW	230	2.8	12.4	7 gal/21 liters
				200-240	2.2-3.1	10.9-13.0	6-7 gal/22-21 liters
E1221IN-1B130-MM006 International-UK Plug	UK Plug TypG BS 1363 A	SM	1 X 3.0 kW	230	2.8	12.4	7 gal/21 liters
				200-240	2.2-3.1	10.9-13.0	6-7 gal/22-21 liters
E1221IN-1B130-PM006 International-UK Plug	UK Plug TypG BS 1363 A	SP	1 X 3.0 kW	230	2.8	12.4	7 gal/21 liters
				200-240	2.2-3.1	10.9-13.0	6-7 gal/22-21 liters

Electrical Specifications for CE equipment UK cord and plug Note Note: All equipment is NSF and CE certified 50Hz or 60Hz

SKU	Electrical Connection	Brew Basket	Heater Configuration	Voltage	KW	Amp Draw	Brew-Volume/Hour
E1221CE-1B130-LM006 International-UK Plug	UK Plug TypG BS 1363 A	LM	1 X 3.0 kW	230	2.8	12.4	7 gal/21 liters
				200-240	2.2-3.1	10.9-13.0	6-7 gal/22-21 liters
E1221CE-1B130-KM006 International-UK Plug	UK Plug TypG BS 1363 A	LP	1 X 3.0 kW	230	2.8	12.4	7 gal/21 liters
				200-240	2.2-3.1	10.9-13.0	6-7 gal/22-21 liters
E1221CE-1B130-MM006 International-UK Plug	UK Plug TypG BS 1363 A	SM	1 X 3.0 kW	230	2.8	12.4	7 gal/21 liters
				200-240	2.2-3.1	10.9-13.0	6-7 gal/22-21 liters
E1221CE-1B130-PM006 International-UK Plug	UK Plug TypG BS 1363 A	SP	1 X 3.0 kW	230	2.8	12.4	7 gal/21 liters
				200-240	2.2-3.1	10.9-13.0	6-7 gal/22-21 liters



Starting The Brew

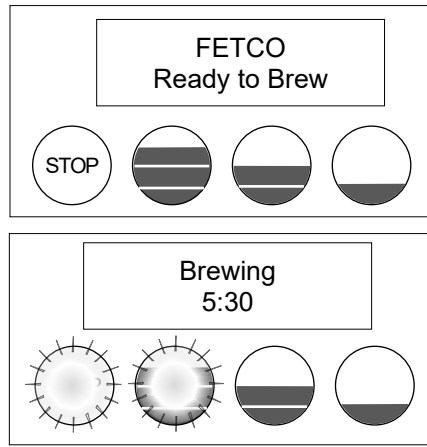

1. Turn the power switch "ON".
2. Prepare a brew basket with the correct size filter and appropriate amount of coffee.
3. Slide the brew basket completely into the rails.
4. Place a clean, empty, preheated dispenser under the brew basket.
5. Select a batch & hold the corresponding BREW button in for 1 second to start
6. -STOP button will illuminate, Brew Selector button will illuminate
-Countdown time will display. Default time setting is 6:00 (six minutes)
-Selected BREW button will slowly pulsate to indicate brew is in progress.
-All other BREW buttons for that brew head will be unlit.
7. When the brew cycle is finished, STOP button will extinguish and the BREW button will continue to pulsate to indicate DRIP will display to show the 2:00 (two minutes) drip delay setting. This indicates that coffee may still be dripping from the brew basket For safety- do not remove brew basket until drip-out is complete.

Enter Programming

There are 7 menu groups-A-F plus EXIT (G).

See the following pages for the batch parameter definitions and all settings for the brewer

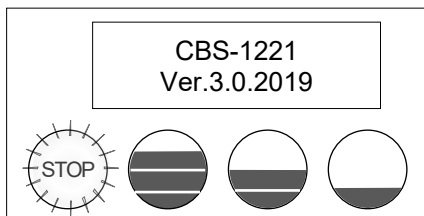

TO ENTER PROGRAMMING

- 1-Turn brewer "OFF" from power switch
- 2-Turn power switch to "ON"

...Screen will initialize and then display digital process notifications

- 3-After Initialization- "STOP" Lamp turns on
- 4-Quickly press "STOP" button (no need to hold)

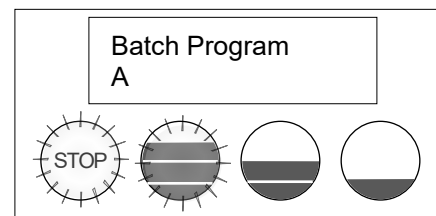
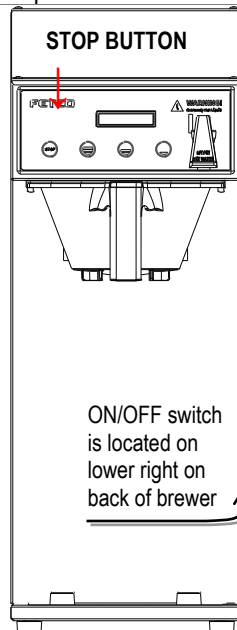

When brewer is In PROGRAMMING MODE
-the screen will display:

BATCH PRG!
A (or B-F)

-Illuminated LED indicates active keypad positions

See the following pages for batch parameter definitions and all settings for the brewer

Exit Programming & Save Control Setting Changes

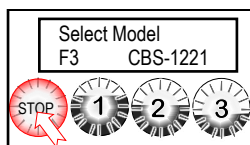

Model Selected
In "F" Screen
(CBS-1221 shown)
Press "STOP" 3X to proceed to "SAVE"

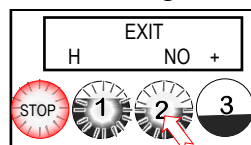

From the "H" screen
Press button **2** to toggle to the EXIT-YES screen.

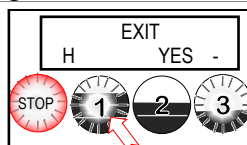

From EXIT screen
Press button **1** to toggle to the SAVE YES screen

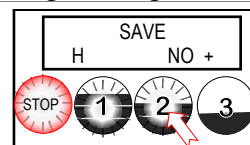

From SAVE screen
Press button **2** to toggle to the SAVE-YES screen

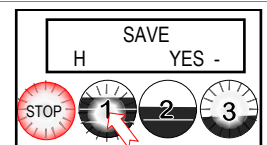

To SAVE and EXIT
Press button **1** to SAVE your changes and EXIT to OPERATING MODE

Programing Menu Layout

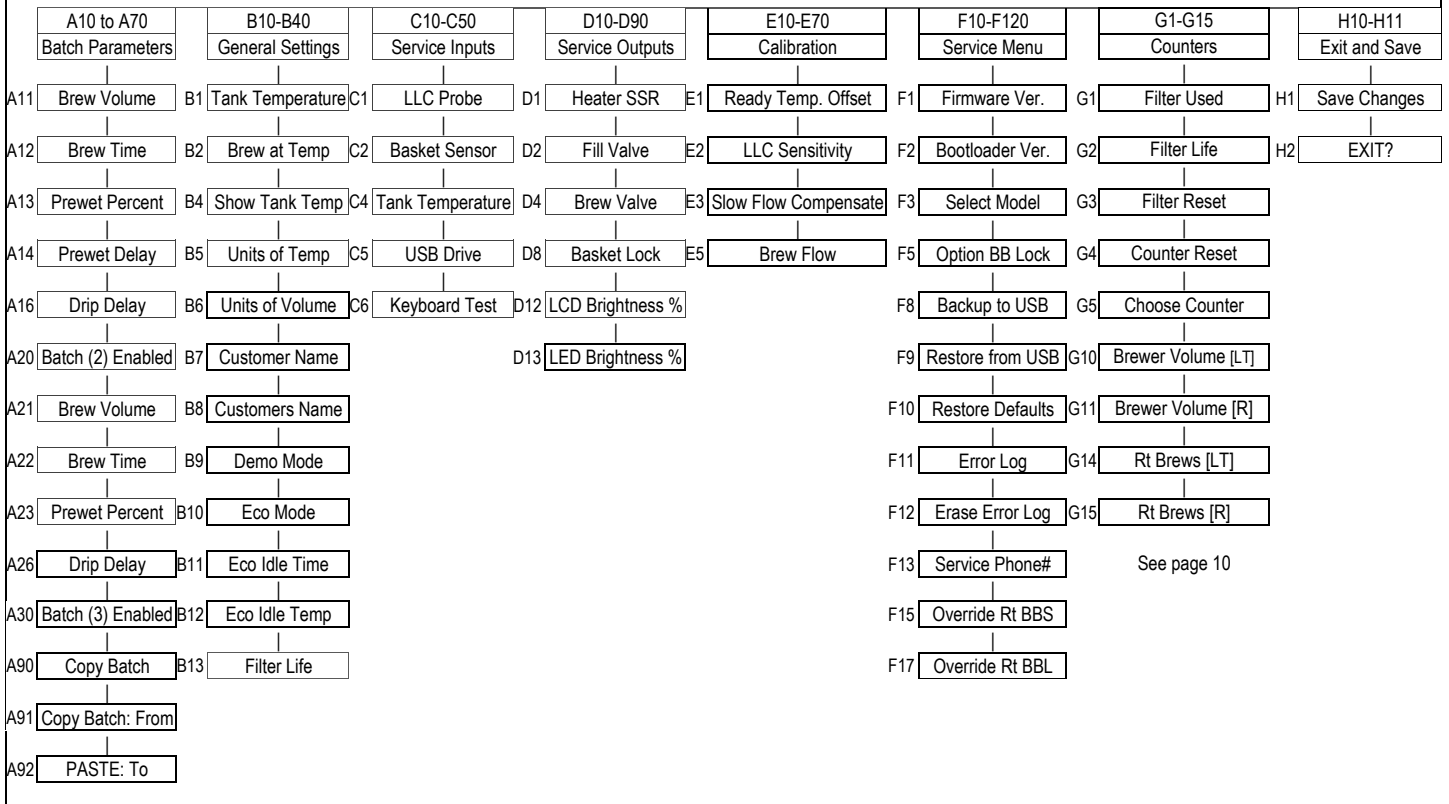

The A menus [A1-3] correspond to batch buttons [1-3] on the touch panel

Access the A menus to PROGRAM & make changes to individual menu recipes. Menu settings can be copied
Menu position A1 is permanent. Menus A2, A3 can be removed by operator if desired

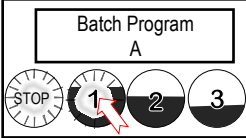
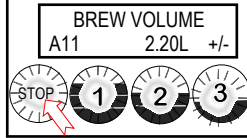
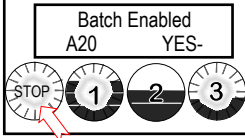
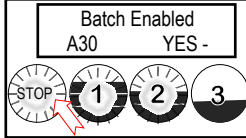
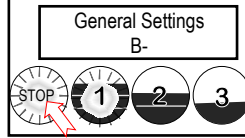
 <p>From A PRG screen Press button 1 to go to the A menu access screen</p>	 <p>From A11 screen Press STOP to scroll to A20. (A1 is permanent)</p>	 <p>From A20 screen Press STOP to scroll to the third batch in the "A" menus. Make any changes as required</p>	 <p>From A30 screen Press STOP to scroll through COPY and further to remaining programming keys.</p>	 <p>To continue Press STOP to scroll through sections See SAVE & EXIT in previous table</p>
--	---	--	---	---

RECIPE Location map

View and change settings for the brew recipes from the "A" screens with the controls in PROGRAMMING.

The batch A1 position is permanent and cannot be disabled

To access programming steps A20 and A30

Batch programming steps A20 or A30 will not display from step A10
Programming for steps A20 and A30 are accessed from any step in A10 by pressing the STOP button (one time for A20; two times for A30).

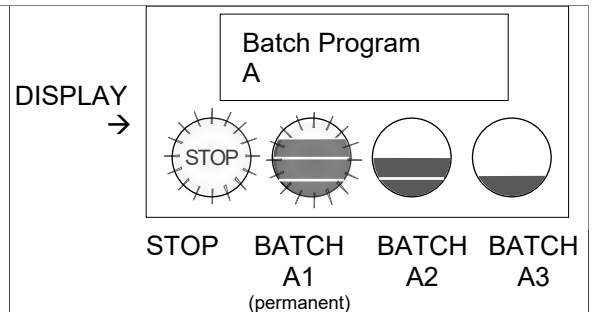

A PROGRAM **Menu Features: Batch Parameters**

The settings below are shown for the top batch on a single brewer top left button on a twin brewer.
See how to access all A menus on the previous page. Below are the brew settings for default A1 & A2 batches

POSITION	Program Items	Factory set Default	Programming Range	Increments	Notes
A11	Batch Volume	2.20liters 0.58gal	0.95 to 3.25L 0.25 to 0.85 gal	0.05L 0.01G	Unit software is in liters; Can convert to gallon
A12	Brew Time (MIN:SEC)	3:30 minutes	2:00 – 12:00	30 sec	Default total brew time is 6:00 minutes
A13	Prewet Perc.	0%	0.00 – 25.0%	1%	Percentage of total brew volume
A14	Prewet Delay (Pause after prewet completes)	0% [1:00 Min]	[0:10 – 5:00]	10 sec	The time between prewetting and start of brew cycle. This feature appears ONLY if Prewet >0:00
A16	Drip Delay	1:30 mm:ss	0:30 – 6:00 min.	10 sec	Time brew basket should remain in place during final drip-out →Drip delay remains “ON” for 2:00 minutes if STOP is pressed during brew †

To access programming steps A20 and A30

Batch programming steps A20 or A30 will not display from step A10

Programming for steps A20 and A30 are accessed from any step in A10 by pressing the STOP button (1x for A20;2x for A30).

A20	Batch Enabled A20 YES - NO +	YES (Active)	Middle and Bottom batches A2,A3	Batch on or off	Batches may be individually enabled, rewritten or deactivated
A21	Batch Volume	1.90liters 0.58gal	0.95 to 3.25L 0.25 to 0.85 gal	0.05L 0.01G	Unit software is in liters; converts to gallon
A22	Brew Time (MIN:SEC)	3:00 minutes	2:00 – 12:00	30 sec	Default total brew time is 6:00 minutes
A23	Prewet Perc.	0%	0.00 – 25.0%	1%	Percentage of total brew volume
A24	Prewet Delay (Brew pause after prewet completes)	0% [1:00 Min]	[0:10 – 5:00]	10 sec	See Note A14
A26	Drip Delay	1:30 mm:ss	0:30 – 6:00 min.	10 sec	→See Note A16
A30	Batch Enabled A30 YES - NO +	NO-inactive (defaults to recipe A20 if activated)	Middle and Bottom batches A2,A3	Batch on or off	Batches may be individually enabled, rewritten or deactivated
A90	Batch Copy				
A91	Batch Copy Copy From Batch	1 +	A91 1 (1-6)		Select recipe to copy
A92	(PASTE TO) Paste To Batch?	1 +	A92.1 (1-6)		Select where to paste

A11 Single Topmost Batch cannot be disabled. A21 & A31 middle and bottom batches may be disabled.
† DRIP DELAY will not activate when STOP is pressed within 5 seconds of starting a brew time

B GENERAL Brewer Operation Control Settings, Adjust Brew Flow Rate					
POSITION	Program Items	Factory set Default	Programming Range	Increments	Notes
B1	Tank Temp.	200°F-or-93°C NOTE: Units are Fahrenheit by default	171° to 207°F 77° to 97°C	1.0°F 0.5°C	Chart to correct for high altitude below
B2	Brew at Temp.	"YES"	ON/OFF	YES/NO	SEE NOTE BELOW
B4	Show Tank Temperature	YES	YES/NO		To display HW tank temperature on screen
B5	Units of Measure TEMPERATURE	° Fahrenheit	Fahrenheit/Celsius	C/F	NOTE: Overwrites user settings (see page 9)
B6	Units of Measure VOLUME	L LITERS	Gallons/Liters	L/Gal	NOTE: Overwrites user settings (see page 9)
B7	Customer Name	Off	NO or YES		For name on screen
B8	Customer Name	(only if above is "ON")	Scroll with batch keys	A-Z;a-z;0-9	16 characters total
B9	Demo Mode	DEMO ON/OFF			Demonstrates the controls for training. Disables all components in demo mode
B10	Eco Mode	Off	ON/OFF	YES/NO	If Selected: Lowers hot water tank temperature after preset time of inactivity
B11	Eco Idle Time (turns on if B10 active)	1Hr	1-6 hours	1 hour	Time of inactivity to go into ECO Mode
B12	Eco Idle Temp (turns on if B10 active)	169°F	158-176°F	1 degree	Temperature that hot water tank is lowered to
B13	Filter Life	OFF	ON/OFF	YES/NO	Water filter life is accessed in G-Counters. This is user set and will display indicator to change water filter

BREW AT TEMPERATURE DEFINITIONS

<p>DEFAULT: BREW AT TEMP: "ON"</p> <p>(FACTORY DEFAULT FOR BREWER) "BREW at TEMP: -Batch will not start if tank temperature is below set point. -Display will show "HEATING" and hot water tank temperature The "BREW START" entry buttons will not illuminate until the hot water tank reaches the selected temperature.</p> <p>Controls allow both sides of dual brewer to operate if one side has an ongoing brew started and the second side brew is selected. Notifications shown on screen: TEXT: HEATING→Tank above 87°C/189°F- will allow brew at low temperature. Coffee flavor may be affected TEXT: L. HEAT→Tank above 76°C/169°F- will allow brew at low temperature. Coffee flavor will be noticeably affected</p>	<p>Tank temp→</p> <p>STOP is not lit → BREW START buttons not lit. and are disabled.</p> <p>Buttons will illuminate "READY" when hot water tank temperature is at setpoint</p>	<p>Hot water tank not at brew temp setpoint.</p> <p style="text-align: center;">HEATING 160°F</p>
<p>USER SELECTABLE OPTION: BREW AT TEMP: OFF (Not recommended) Unit will operate at reduced temperature Allows brewing at any temperature above 90°C/202°F</p>		

[ft]	[m]	Suggested Setting[°F]	Boiling point[°F]	Suggested Setting[°C]	Boiling point [°C]
0	0	205	212.0	96	100.0
500	152	205	211.0	96	99.5
1000	305	200	210.1	93	98.9
2000	610	200	208.1	93	97.8
2500	762	200	207.2	93	97.3
3000	914	200	206.2	93	96.8
3500	1067	197	205.3	92	96.3
4000	1219	195	204.3	91	95.7
4500	1372	194	203.4	90	95.2
5000	1524	194	202.4	90	94.7
5500	1676	193	201.5	89	94.2
6000	1829	192	200.6	89	93.6
6500	1981	191	199.6	88	93.1
7000	2134	190	198.7	87	92.6
7500	2286	188	197.8	86	92.1
8000	2438	187	196.9	86	91.6
8500	2591	185	196.0	85	91.1



C SERVICE INPUTS		Brewer Sensors and Keypad			
POSITION	Program Items	Factory set Default	Programming Range	Increments	Notes
C1	LLC Probe continuity	Direct read	Reading of tank water resistance in TDS	≈850- LOW ≈1600-HIGH	Nominal values
C2	Brew Basket Sensor	Direct read	YES or NO		
C3	Tank Temperature	Direct read	Hot water tank temperature		Actual values
C4	USB Drive	NO			
C6	Keyboard Test	Calibrate	Checks buttons under membrane cover	YES/NO	Follow directions on the touch screen

D SERVICE OUTPUTS		Test Valves and Heaters; Set screen brightness			
POSITION	Program Items	Factory set Default	Programming Range	Increments	Notes
D1	Heater SSR Test	Press button 2 to test (button 1 stops test)	Activates heater Default is 10 sec..	Toggle +/- OFF or ON	Energizes Heater(s) WARNING! Service use only.
D2	Fill Valve Test	Press button 2 to test (button 1 stops test)	Activates valve Default is 10 sec.	Toggle +/- OFF or ON	Press To Test
D4	Brew Valve Test	(Press to test)	Activates valve Default is 10 sec.	Toggle +/- OFF or ON	Runs valve to verify flow. NOTE: Have container under brew basket.
D8	Basket Lock (if activated)	(Press to test)		Toggle +/- OFF or ON	Press To Test
Single series displays right side only Left Valve display is only for twin side brewer.					
D12	LCD Brightness	Brightness=90%	20-100%	5%	Adjust LCD screen brightness only-Not for LEDs under buttons
D13	LED Brightness	Brightness=60%	20-100%	5%	Adjust LED button brightness only-Not for the screen display LCD

E CALIBRATION		Brewer Sensors and Keypad			
POSITION	Program Items	Factory set Default	Programming Range	Increments	Notes
E1	Ready Temp. Offset	-4°F -2°C	-2° to -9°F -1° to -5° C	1°F 1°C	Compensates output to measured temperature
E2	LLC Sensitivity	NORMAL ("NORMAL" for most water)	HIGH (Biased for reverse osmosis water or very pure water)	NORMAL HIGH	Liquid level control sensitivity. High, 1300Ω is for reverse osmosis water or very pure water.
E3	Slow flow rate from supply	ON	OFF/ON	Toggle +/- YES or NO	Trims fill system for low supply or Flojet use
E5	Brew valve flow rate:	1.60L/0.42G/54oz	1.30-1.90 Liter 0.35-0.48Gallon 0.54-0.63 ounce	0.05L 0.013G 1.0 ozs1	Adjusts flow rate

Use this formula to compensate for minor discrepancies in actual volume versus programmed volume.
See "PROGRAM" E5 For valve settings and calibration. Factory set brew valve flow rates are in liter/min

$\frac{\text{ACTUAL VOLUME}}{\text{PROGRAMMED VOLUME}} \times \text{CURRENT SETTING} = \text{NEW SETTING}$	Default Brew Valve Flow Rate—CBS-1221 Brewers		
	CBS-1220	Liters/minute	Range
	Brew Valve FR	1.60	1.30 L to 1.90 L

Set FR lower to increase volume, set higher to decrease volume.
Use the formula above to determine the correct setting

F SERVICE MENU					
Software & Code View and Settings					
POSITION	Program Items	Factory set Default	Programming Range	Increments	Notes
F1	Display Firmware	2.3.220812			Displays current version [6/2021]
F2	Display Bootloader	2.2.220811			Displays current version [6/2021]
F3	Select Model	CBS-1221 Will need reboot	Scroll to brewer model Save & Exit	CBS-1221, CBS-1222 CBS-1231, CBS-1232 CBS-1241, CBS-1242 CBS-1251, CBS-1252 CBS-1253; CBS-1261, CBS-1262; MBS-1221 MBS-1222, MBS-1251 TBS-1221, TBS-1222	NOTE: Overwrites all user settings (See below)
F4	Option Bypass	Yes	NO or YES		Turns on bypass
F5	Option BB Lock	NO	NO or YES		Apply to future upgrade kit
F6	Option BBL Sensor	NO	NO or YES		Apply to future upgrade kit
F8	Backup to USB	NO	Follow prompts	Saves settings	Insert blank USB
F9	Restore From USB		Applies settings from USB		Insert USB Will need reboot
F10	Restore Defaults	NO	NO/YES		Reset to factory
When selecting F10-RESTORE DEFAULTS, save and exit programming (page 13) then reenter programming and select your model (F3). Save and exit again after this selection.					
F11	Error Log	Lists up to six codes, in order	1: ; 2: ;3: ;4: ;5: ;6: 1=Newest/6=Oldest LAST six errors only	Newest=first Oldest=last	See Error Code Chart for references
F12	Erase Error Log	NO +		Toggle +/- YES or NO	FACTORY USE ONLY. DO NOT RESET
F13	Service Phone #				Set phone for brewer operator
F15	Override Rt BBS	NO	NO/YES	Toggle +/- YES or NO	Disables brew basket sensor
F17	Override Rt BBL	NO	NO/YES	Toggle +/- YES or NO	Disables brew basket lock



F Error Codes			
DO NOT CLEAR ERROR CODES UNTIL ERROR IS IDENTIFIED AND CORRECTED			
→Contact factory or specialized personnel for error codes			
Code	Description	Possible Cause	Corrective Action
001	Software error-error on start up or corrupted software	Improper start-up or shutdown	Restart, if still fault: reload software
002	Internal flash corrupted internal data memory malfunction	Error found in cyclic redundancy check CRC	Restart, if still fault: reload software If not corrected: replace board
050	Short-circuit in temperature probe	Probe failure.	Replace probe.
051	Open temperature probe.	Bad probe connection, or probe failure.	Check all connections. Replace probe if necessary.
100	Initial Fill Error. Initial fill time took longer than expected after powering up.	Water supply flow rate is too low, fill valve is stuck, water line kinked or closed.	Reboot machine. If persists-investigate cause of low flow rate. (Clogged water filter, kinked line, stuck fill valve)
101	Error on refill-. Tank did not refill within expected time.	Water supply flow rate to hot water tank is too low, or fill valve stuck or damaged (SEE PAGE 14)	Check water supply line. Flow should be 20-75 psig, (138-517kPa) >1gal/3.8L/min Investigate cause of low flow rate. If the flow rate is in range-replace fill valve
200	Heating flatline-Tank is boiling	Heater is on, temperature is not rising/dropping	High elevation correction. Bad heaters or temperature probe or position
201	If the hot water tank heaters are turned on during a heating cycle and tank temperature is not increasing according to software logic and the tank temperature is below setpoint	1) Failure of SSR, high limit, temperature probe, or heating element. 2) Water being removed by hot water faucet during heating (control displays "heating")	1)Test and check SSRs, high limit devices temperature probe. Check heating elements with current clamp, replace if necessary. 2)Advise staff to refrain from taking large amounts of water from hot water tank, especially during "heating".
202	Heater Shorted or Stuck SSR	Heater is off and heating SSR is stuck "ON"	Check ohms on heater (15-60Ω). SSR may be stuck in ON mode-replace SSR.
255	Keyboard [HID] error (Human Interface Device)	Usually from longer than 10 seconds' contact. Or faulty reassembly after service	Restart, if still fault: reload software. If mechanical: replace module
NO BSKT <u>Insert Brew Basket</u>		Brew basket must be in place This is a SAFETY FEATURE	Insert brew basket into brewer rails to enable brewer

G COUNTERS Brewer Usage, Water Filter Usage, and Statistics

ROLE: [LT]=Permanent total for lifetime of machine [R]=operator resettable [User]=Input needed from operator

Position	Counter	Program items	Role	Information	Increments	Notes
G1-G3 are for water filter maintenance. Filter Life readings (G1, G2, G3) must be activated in B13 GENERAL if they are not visible and the equipment has a water filter. All beverage equipment must use filtered water and filter cartridges must be monitored for quality						
G1	A, S, B	Filter Used	[User]	0L	Gallons/Liters	Amount of water passed through external water filter. For filter life
G2	A, S, B	Filter Life	[User]	10,000Liters 2,625Gal	25 gal 100 L	Upload published life of filter
G3	A, S, B	Filter Reset	[User]	NO	Toggle +/- ,Y or N	Reset when replacing external water filter
G4	A, S, B	Counter Reset	[User]	NO	Toggle +/- ,Y or N	Resets all resettable counters to zero
G5	A, S, B	Choose Counter		Factory set to BASIC	Basic= B Advanced= A Statistical= S	Stored brewer component activity.. See column 2, Counters , to identify where counters are located.

G10-G15 Number of brews and volumes handled. Available in BASIC counter only (G5)

G10	B	Brewer Volume	[LT]	Dispensed volume	Liters/ Gallons	Total of brews and hot water dispensed
G11	B	Brewer Volume	[R]			
G14	B	Brews	[LT]	Total number of brews	Count	Total brews
G15	B	Brews	[R]			

G20-G55 component use cycles and volumes handled. Available in ADVANCED counter only (G5)

G20	A	Fill Cycles	[LT]	Hot water tank refill cycles	Count	Cycles of hot water tank refill
G21	A	Fill Cycles	[R]			
G22	A	Fill Volume	[LT]	Total volume of water for all brews	Liters/ Gallons	Quantity of water for brews
G23	A	Fill Volume	[R]			
G28	A	Rt Brew Cycles	[LT]	Right brew valve operation on/off	Count	Totalized cycles of valve operation
G29	A	Rt Brew Cycles	[R]			
G30	A	Rt Brew Volume	[LT]	Right brew valve flow through volume	Liters/ Gallons	Totalized volume through right valve
G31	A	Rt Brew Volume	[R]			
G52	A	Heater Cycles	[LT]	ON/OFF switching for heating elements	Count	Totalized cycles of heater switching
G53	A	Heater Cycles	[R]			
G54	A	Heater On Time	[LT]	Total ON time for heating element	Hour	Totalized heater ON time in hours
G55	A	Heater On Time	[R]			

G80-G85 See illustration below for batch button positions Available in STATISTICAL counter only (G5)

G80	S	Batch 10 Cycles	[LT]	Menu button selection and activation count	Count	Total brews-top button
G81	S	Batch 10 Cycles	[R]			
G82	S	Batch 20 Cycles	[LT]	Menu button selection and activation count	Count	Total brews-middle button
G83	S	Batch 20 Cycles	[R]			
G84	S	Batch 30 Cycles	[LT]	Menu button selection and activation count	Count	Total brews-bottom button
G85	S	Batch 30 Cycles	[R]			

H SAVE & EXIT

Saving changes and exiting PROGRAMMING

The brewer will save changes only from the "H" menu. **DO NOT** reboot brewer or toggle ON/OFF-exit as below.

TO EXIT PROGRAMMING & HOW TO SAVE CONTROL SETTING CHANGES

HOW TO SAVE CHANGES AND EXIT-*The brewer is in PROGRAMMING mode.*

A convenient way to access the steps is to remember to scroll to EXIT → YES and to SAVE → YES

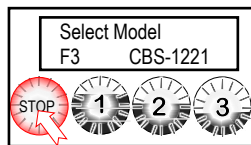

Model Selected
In "F" Screen
(CBS-1221 shown)
Press "STOP" 3X to
proceed to "SAVE"

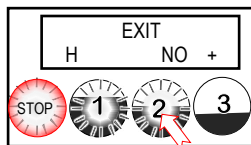

From the "H" screen
Press button **2** to
toggle to the EXIT-YES
screen

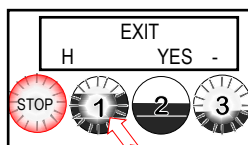

From EXIT screen
Press button **1** to
toggle to the SAVE
screen

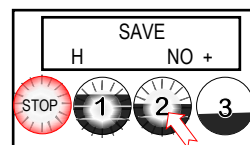

From SAVE screen
Press button **2** to
toggle to the SAVE-
YES screen

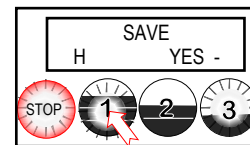

To SAVE and EXIT
Press button **1** to
SAVE your changes
and EXIT to
OPERATING MODE

NOTE: User Settings will be erased and overwritten to factory default settings by the following five programming changes

- 1) When setting or changing units of display for the tank temperature (F Fahrenheit or C Celsius). **(SETTING B4)**
- 2) When setting or changing units of display for the volume (L liters, G gallons). **(SETTING B5)**
- 3) When setting brewer model → The software sets equipment to brewer defaults **(SETTING F3)**
- 4) When loading from USB (Reprograms settings) **(SETTING F9)**
- 5) When restoring defaults (Reloads to defaults) **(SETTING E10)**

Operator Training

Review the operating procedures with whoever will be using the brewer.

Pay particular attention to the following areas:

1. Always pre-heat the dispensers before the first use of each day by filling them halfway with hot water and letting them stand for at least 5 minutes.
2. Do not remove the brew basket from a coffee brewer until it has stopped dripping.
3. Make sure the dispenser is empty before brewing into it.
4. Show how to attach covers, close, and or secure the dispensers for transporting.
5. Show the location and operation of the water shut off valve as well as the circuit breaker for the brewer.
6. Steam from the tank will form condensation in the vent tubes. This condensation will drip into and then out of the brew baskets. Up to 1/4 cup/118cc discharging overnight is possible. Place an appropriate container under each brew basket when not in use.
7. We recommend leaving the power to the brewer on overnight. The water tank is well insulated and very little electricity is used to keep the tank hot. Leaving the brewer in the "ON" position will also avoid delays at the beginning of shifts for the brewer to reach operating temperature.

Cleaning & Maintenance

After Each Brew:

1. Dispose of grounds and rinse brew basket.
2. Never strike a brew basket or hit it against a hard surface.
This will damage the brew cone, and may damage the brew basket support rails
3. Rinse dispensers before reuse.

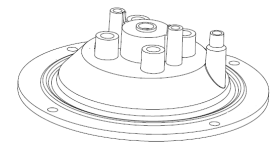

Every Day:

1. Wash brew basket with hot sudsy water.
2. Pull CSD from the spray head, it is magnetically attached. Use gloves or a heavy towel. →
Wash off any film and reattach. Use vinegar if limescale filming is present.
3. Clean dispensers with hot suds water and a brush, rinse and air dry.
4. Use only a soft cloth and hot suds on the outside to avoid scratches. Never use abrasives that will scratch surface.

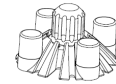

Weekly

1. Use a commercial coffee dispenser cleaner such as URNEX™, TABZ™, DIP-IT™ or Squeak 'n Clean™.
2. Carefully Follow the instructions supplied with the cleaning product
3. Never use spray cleaners, solvent, solvent based cleaner or petroleum based polish anywhere on dispensers

Warning

1. Turn off power before any cleaning procedure, including wiping the exterior for appearance reasons.
2. Dry the exterior, especially the face panel, before turning on power.
3. Do not apply any type of spray cleaner on the face panel of this equipment.
4. Never use solvent or solvent-based cleaner or petroleum based polish anywhere on this equipment.
5. Dry the face of the touch pad before turning on power
6. Do not electrically energize this equipment or attempt operation without all covers in place and all screws fastened.
7. Unplug machine before disassembly or servicing.

Safety Notes

1. Professional installation is required. This appliance is manufactured only for commercial use
2. Operational requirements and maintenance for commercial cooking appliances differ from household appliances.
3. Operators must be trained for this equipment and must understand the use, maintenance and hazards.
4. Access to the service area is restricted to persons having safety/hygiene knowledge and practical experience of the coffee brewer. This appliance must be installed in locations where it can be overseen by adult trained personnel.
5. Do not attempt to move hot beverage equipment once it is filled. Drain equipment before moving.
6. FETCO commercial coffee brewers prepare large amounts of coffee or tea in a single batch using very hot water
7. Commercial coffee brewers provide very hot water from the spray head, brew basket and faucet when it is pulled.
8. Coffee brewers may continue to dispense very hot water from the mechanically operated faucet after the electronic touchpad is completely disabled by turning off the power switch on the lower back of the unit or unplugging the unit.
9. For safety, the brewer control locks the brew basket for 6.0 minutes after starting the brew.
10. Never attempt to defeat the factory set (default) time that the brew basket is locked for safety from start of brew.

Keep these instructions for training and future reference.

General:

1. If not installed correctly by qualified personnel, the brewer will not operate properly, and damage may result.
2. Utilize only qualified beverage equipment service technicians for service and installation.
3. Always have an empty dispenser under spray head of all coffee brewing equipment-including when at idle
4. Damages resulting from improper installation are not covered by the warranty and will void the warranty.

Below are the key points to consider before installation:

Electrical:

1. All CBS_Series brewers require **an electrical ground wire**. Installation without grounding is dangerous.
2. Note Equipotentiality Terminal, if present, (To identify the terminals which, when connected together, bring the various parts of equipment or of a system to the same potential, not necessarily being the earth (ground) potential, e.g. for local bonding.)
3. Verify voltages, polarity, circuits, and circuit breaker access before attaching equipment.
4. Brewers in this series wire differently in regard to a neutral wire. Review the wire diagrams.
5. The electrical diagram is located in the User's Guide and online at www.fetco.com.
6. Make sure of the tight grounding of the equipment and use the external ground bolt.
7. The installation must comply with applicable federal, state, and local codes having jurisdiction at your location.

Check with your local inspectors to determine what codes will apply.

→See wiring diagrams on pages 14, 21&22 for connections

Plumbing:

1. North America: All installations must comply with applicable federal, state, or local plumbing codes.
2. All Others: The water and waste piping and connections shall comply with the International Plumbing Code, International Code Council (ICC), or to the Uniform Plumbing Code (UPC).
3. Install a backflow prevention device. Most municipalities require a recognized backflow preventer
Usable on all hot beverage and cold beverage equipment is a WATTS® SD-2 or SD-3.
WATTS spring loaded double check valve models are accepted by most zoning authorities.
→The check valve should be as close to the water supply inlet of the beverage equipment as possible
4. All beverage equipment must use a water filter. A finishing carbon filter is preferred
5. Install the filter unit after a water shutoff valve and in a position to facilitate filter replacement.
6. The water line and newly installed filter cartridge must be flushed thoroughly prior to connecting it to the brewer to prevent debris from contaminating the machine
7. Verify that the water line will provide a flow rate of at least 1½gpm/(5.7lpm) per minute and the water pressure is between 20-75 psig (138-517kPa) before making any connections
8. Only use the supplied factory fitting to attach water supply line to brewer (shipped in brew basket) **SEE PAGE 14**
9. The supplied fitting is a 1/4" flare/compression fitting for 1/4" supply line. Other adaptors may be substituted.
10. Hand tighten the factory fitting when connecting the stub on the brewer. This will reduce stress on the internal connections and reduce the possibility of leaks developing after the install has been completed

Tank Drain

The water tank must be drained before maintenance procedures, and when the unit is to be relocated or shipped.
Drain is for service use only and must not be permanently connected. NOTE: Never permanently plumb a drain line.

1. Disconnect power and water to unit. DANGER: Ensure that all utility connections to the brewer are broken.
2. Move the unit near a sink or obtain a container large enough to hold four gallons of water.
→Note: The hot water tank holds approximately 2¾ gallons/10.1 liters.
3. Remove the front panel and tank cover and allow the tank to cool to a safe temperature
4. The tank drain line and clamp are located inside-under the hot water tank. Pinch the drain line clamp to close
5. Locate the fill valve against the back wall, using pliers, loosen the hose clamp and move it back over the tube.
→Note Do not loosen the hose clamp to the bottom of the hot water tank
6. Crimp the tube an inch or two away from the drain plug to prevent water from flowing and pull it off the valve.
7. Pull the tube end out of the brewer and position over sink or bucket.
8. Release the crimped tube and hose clamp and allow the water to flow into the sink or container.
9. Reverse steps 4-8 when service is complete. Ensure pinch clamp is open and hose clamps are in place.

Brewer Setup

Attach water inlet adapter

Place rubber washer with screen in adapter. Hand tighten only-and 1/4 turn with wrench

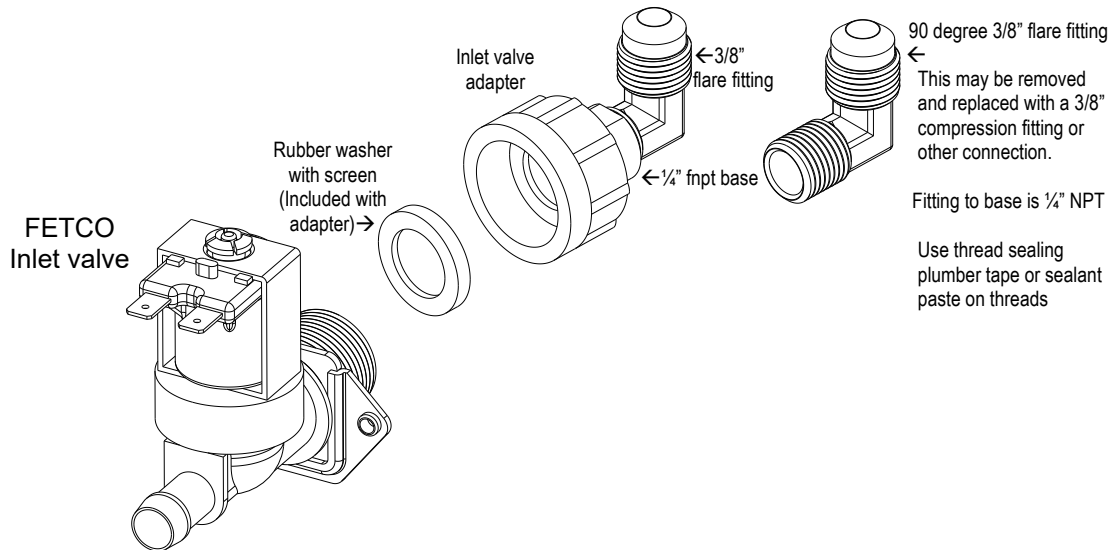

Install the adapter on inlet valve first before attaching water line. Adapter is shipped in the brew basket
The valve threads are 3/4" BSP MALE THREAD and are not 3/4 garden hose fittings.
Use of any other connector to valve will damage the valve
DO NOT use USA dishwasher water adapter or USA washing machine adapter for this connection.
The threads on these USA adapters are unusable for the valve

TO PREVENT DAMAGE AND INSURE PROPER EQUIPMENT OPERATION

The inlet valve thread is 3/4 INCH BSP (British Standard Pipe).

This valve is not a standard USA washing machine or dishwasher thread (3/4" GHT)

-Use only the plumbing adaptor kit included with this equipment. Use the gasket included in adaptor kit

-Plumber's tape is not recommended for the adapter to valve connection

-Hand tighten adapter on valve with gasket, then very lightly wrench 1/4 turn to set

-DO NOT SUBSTITUTE FITTINGS FOR CONNECTING TO WATER SUPPLY

Damage to inlet valve from improper installation will void the warranty

NOTE: DO NOT TANK PLUMB DRAIN. DRAIN IS FOR SERVICE AND MAINTENANCE.

Installation safety and hygiene directions-For International and CE equipment

1. Access to the service area is restricted to persons having safety/hygiene knowledge and practical experience of the coffee brewer. This appliance must be installed in locations where it can be overseen by trained personnel.
2. For proper operation, this appliance must be installed indoors where the temperature is between 10°C/50°F to 35°C/95°F. Drain and remove all liquid from equipment and lines if exposed to freezing temperatures.
3. All commercial cooking equipment, including this unit, is not intended for use by children or persons with reduced physical, sensory, or mental capabilities. Ensure proper supervision of children and keep them away from the unit.
4. Children should be supervised to ensure that they do not play with hot beverage equipment.
5. This unit must be installed and serviced by qualified personnel only.
6. Installation must conform to all local electrical and plumbing codes. Installation by unqualified personnel will void the unit warranty and may lead to electric shock or burn, as well as damage to unit and/or its surroundings.
7. If the power cord requires repair or replacement-it must be performed by the manufacturer or authorized service personnel with the specified cord only from the manufacturer in order to avoid a hazard.
8. Review the dimensions for the unit and verify that it will fit properly in the space intended for it. Verify that the counter or table will support the total weight of the brewer and dispensers when filled (See: Technical Data).
9. Place the brewer on the counter or stand. When the brewer is in position, level it front to back as well as side-to-side by adjusting the legs.
10. Brewers will need a sturdy supported surface for operation. Do not move brewers when filled.
11. Do not tilt appliance more than 10° to insure safe operation.
12. Unit is for protected indoor use only. Do not steam clean or use excessive water on unit.
13. This unit is not "jet-proof" construction. Do not pressure wash or use jet spray to clean this unit.
14. The unit is not waterproof-do not submerge or saturate with water.

**Equipment exposed to flood and contaminated must not be used due to electrical and food safety.
Do not operate if unit has been submerged or saturated with water.**

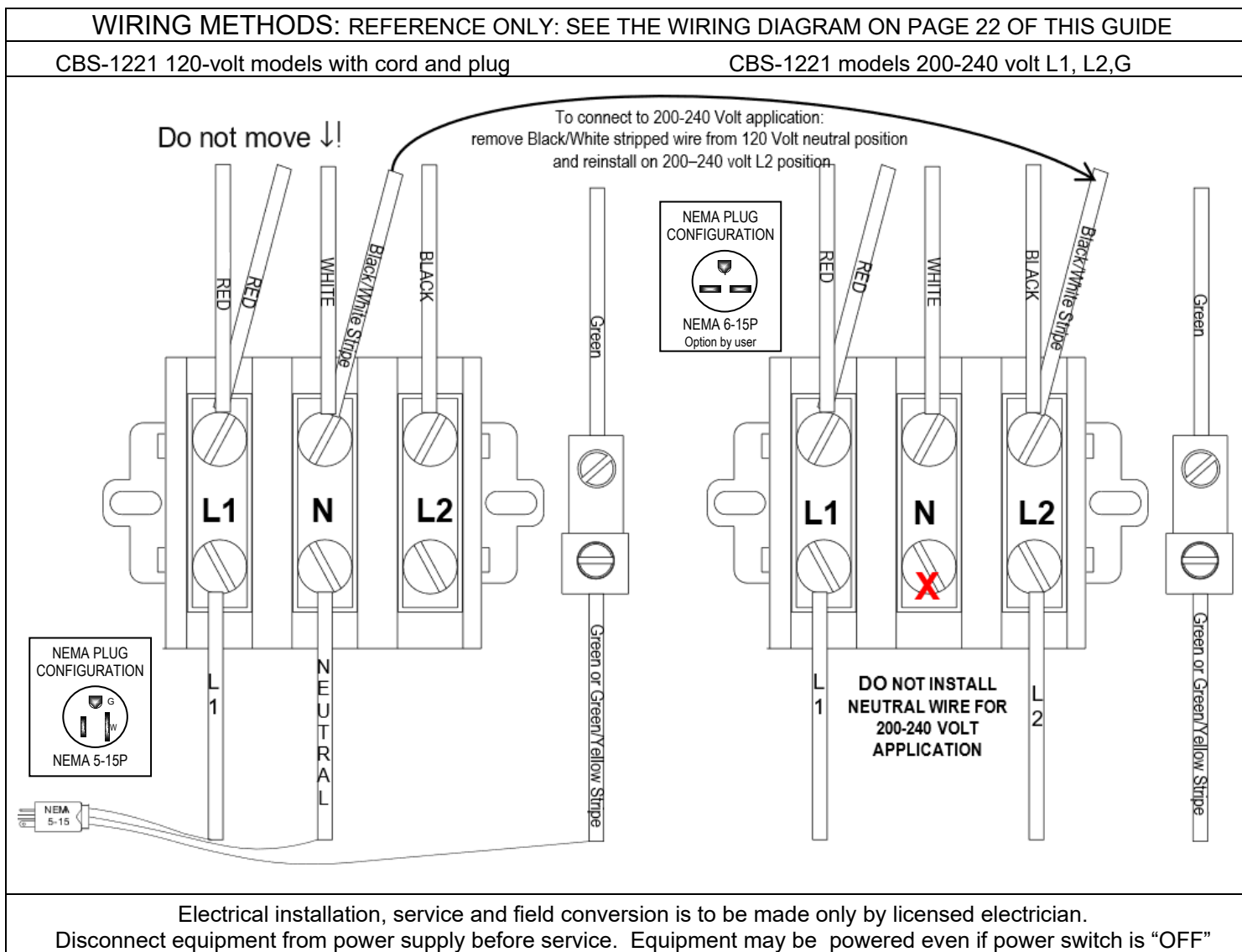

Small Spray Head Assembly CBS-1221 Part #16 pages 15-16 (Check your equipment to determine your type)

FETCO 24 volt small spray dome is found on some models of CBS-1200, MBS-1200, TBS-1200 all models CBS-1131V+, CBS-1132V+ CBS-1141V+, CBS-1142V+

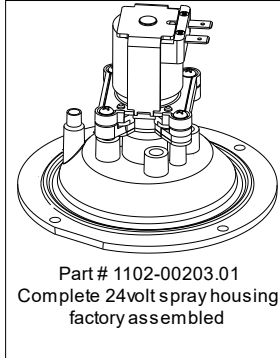

Small spray dome parts breakdown

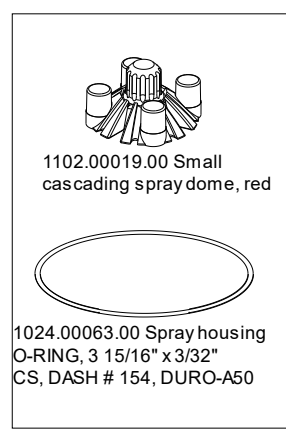
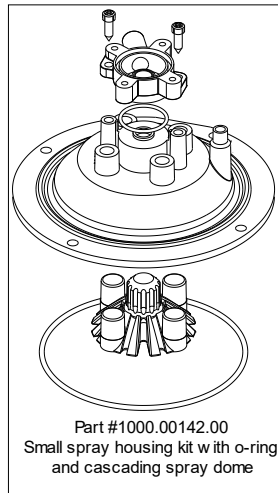
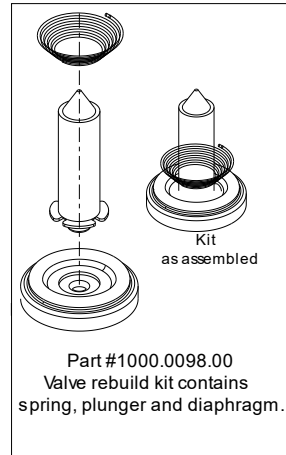
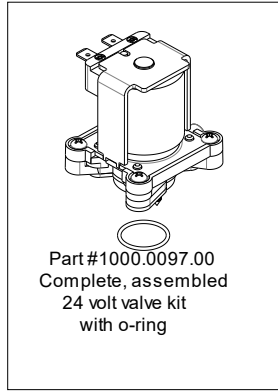
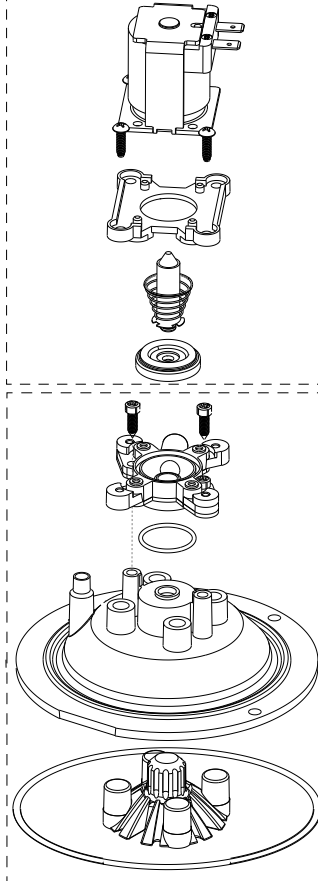

Small Spray Assembly Parts List-alternate version (Check your equipment to determine your type)

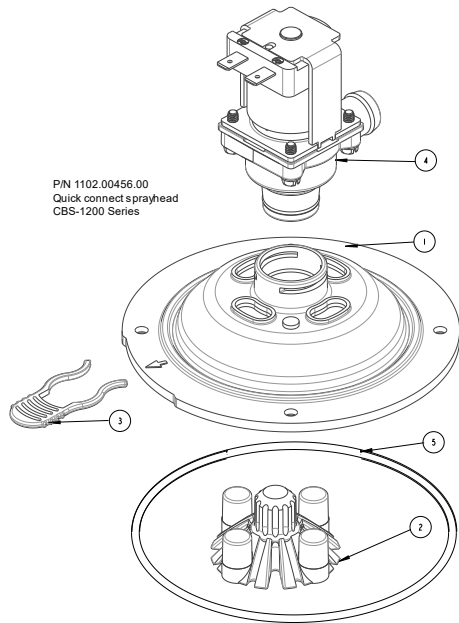

ITEM	Qty	PART NO	DESCRIPTION	Drawing number 1101.00569.00
1	1	1000.00142.00	BASE, QUICK CONNECT SPRAY HEAD, RETROFIT	
2	1	1102.00479.00	ASSEMBLY, CASCADE SPRAY DOME, NEXT GEN, ORANGE	
3	1	1023.00342.00	QUICK CONNECT CLIP	
4	1	1057.00076.00	VALVE ASSEMBLY, COMPLETE, NG, DELTROL(interchangeable with 1057.00078.00)	
4	1	1057.00078.00	VALVE ASSEMBLY, COMPLETE, NG, RPE (interchangeable with 1057.00076.00)	
5	1	1024.00063.00	O-RING, 3 15/16" x 3/32" CS, DASH # 154, BUNA-N, DURO-A50	
NS	4	1083.00010.00	WASHER, #10 SCREW W/NEOPRENE-BONDED SEAL	
NS	4	1084.00006.00	NUT, 8-32 18-8 HEX MACHINE SCREW	

Parts Diagrams

Drawing Number
1101.00569.00

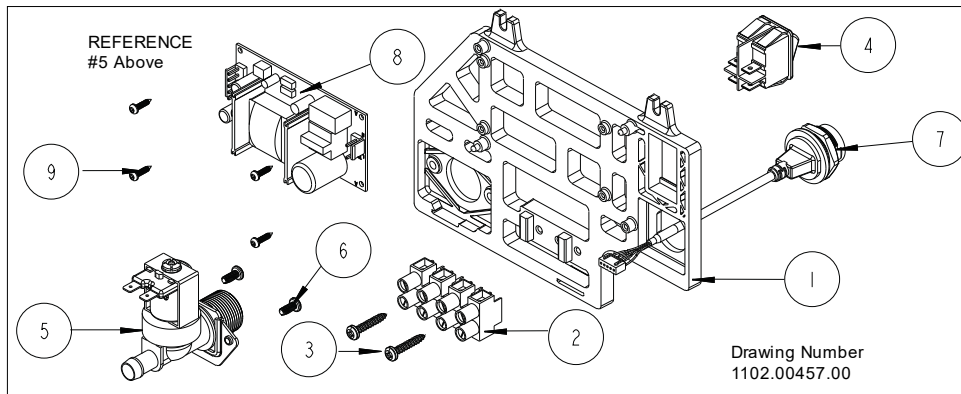
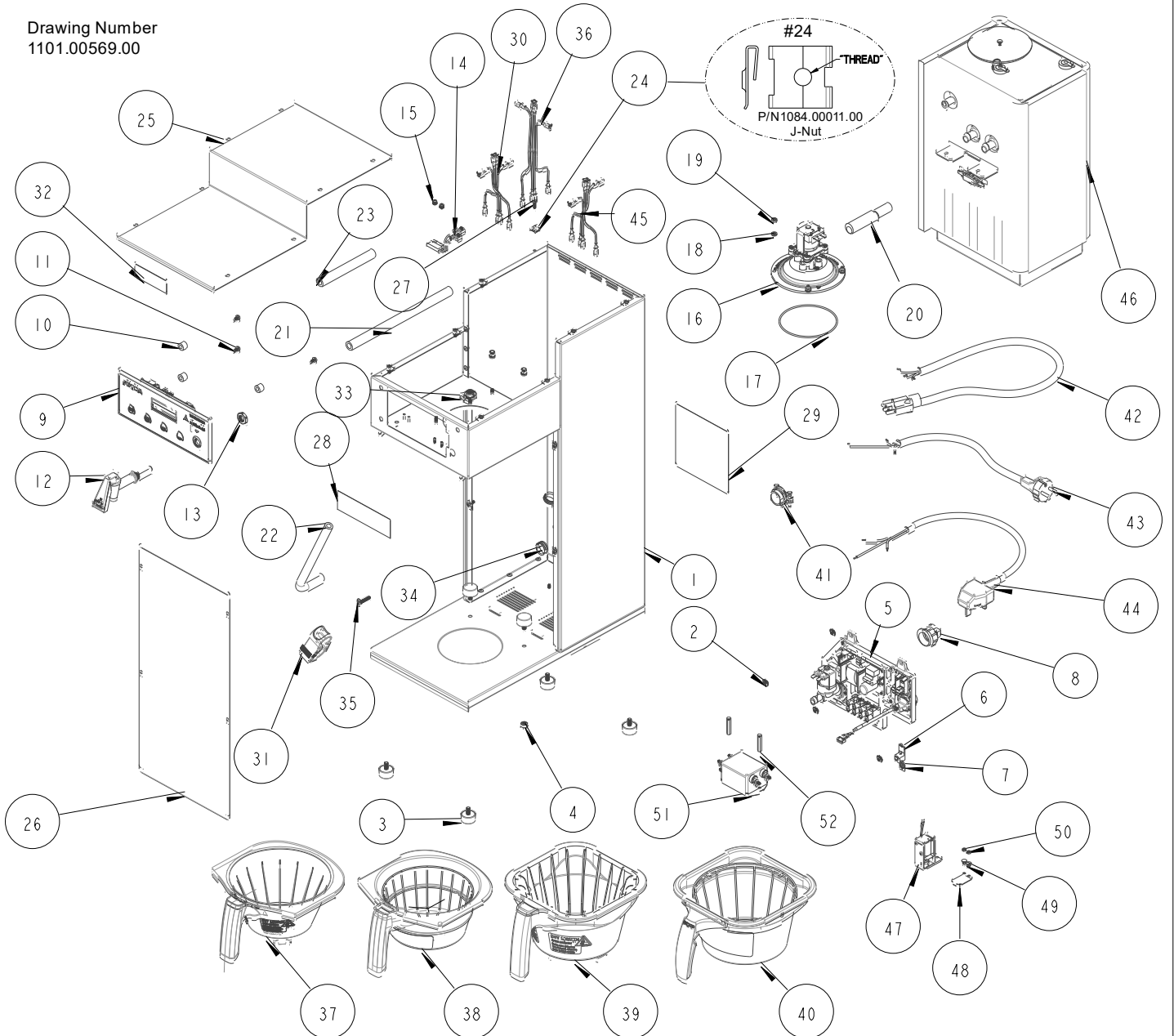

ITEM	Qty	PART NO	DESCRIPTION	Drawing number 1101.00569.00
1	1	1111.00105.00	WELDMENT BODY, CBS-1221	
2	7	1084.00051.00	NUT, HEX LOCKWASHER, #8-32, 18-8 ST. STL.	
3	6	1073.00021.00	FOOT, RUBBER, 1/4-20	
4	2	1084.00017.00	NUT, HEX, 1/4"-20	
5	1	1102.00457.00	ELECTRICAL COMPONENT LATTICE, CBS-1200	
5REF	1	Reference	ELECTRICAL COMPONENT LATTICE, CBS-1200	
5-1	1	1023.00360.00	ELECTRICAL MOUNTING LATTICE, AIR POT	
5-2	1	1052.00023.00	EUROSTRIP HE16 TERM. BLOCK, 4 POLE, 63 AMP, 18-8 AWG	
5-3	2	1082.00056.00	SCREW, #8-11 X 1" PAN HD PHIL, THREAD FORMING	
5-4	1	1058.00024.00	SWITCH, POWER, DOUBLE POLE, 16A, 125/250 VAC	
5-5	1	1057.00043.00	SOLENOID VALVE, 5.5L/min, 180 DEG, 24VDC	
5-6	2	1082.00010.00	SCREW, PAN HD. PHIL. MACH., M4x10 ZINC-PLATED	
5-7	1	1058.00055.00	USB CONNECTOR	
5-8	1	1052.00001.00	POWER SUPPLY, 90-264VAC/24VDC, 1.8A	
6	1	1065.00009.00	GROUND LUG CONNECTOR, 14-2 AWG, ALUMINUM	
7	1	1044.00012.00	LABEL GROUND, CE	
8	1	1102.00164.00	ADAPTER ASSY, 3/4" BSP X 1/4 SAE FLARE	
9	1	1102.00453.00	ASSEMBLY, FRONT PANEL, CBS-1220	
10	3	1023.00361.00	SPACER, UNTHREADED, 1/2"OD X 3/8" LONG	
11	3	1082.00115.00	SCREW, #6 x 3/8" LG., SLOTTED HEX HD. WASHER	
12	1	1071.00055.00	FAUCET, HOT WATER, PSC-BR-8, WITH FLAT AND STEM	
13	1	1084.00048.00	JAM NUT, 1/2-20 UNF, NICKEL PLATED BRASS	
14	1	1102.00113.00	SWITCH, REED, ASSEMBLY	
15	2	1029.00006.00	NUT, FINGER KNURLED, #4-40	
16	1	1102.00203.01	ASSEMBLY, SPRAY HOUSING, DSV P11 DESIGN, NO VENT (Expanded drawing Page 19)	
17	1	1024.00063.00	O-RING, 3 15/16" x 3/32" CS, DASH # 154, BUNA-N, DURO-A50	
18	4	1083.00010.00	WASHER, #10 SCREW W/NEOPRENE-BONDED SEAL	
19	4	1084.00006.00	NUT, 8-32 18-8 HEX MACHINE SCREW	
20	1	1024.00065.00	CONNECTOR, SILICONE, TANK TO BREW VALVE	
21	1	1025.00039.00	TUBE, 5/8" OD X 3/8" ID X 10" LG, DRAIN	
22	1	1025.00058.00	TUBE, 9/16"OD X 5/16"ID X 25.00"LG	
23	1	1025.00046.00	TUBE, 5/8" OD X 3/8" ID X 5.0" LG, DOUBLE VALVE	
24	12	1084.00011.00	NUT, CLIP ON (J-NUT), #6-32, 22-20 GA., BLK-PH FINISH	
25	1	1001.00425.00	TOP COVER, CBS-1221	
26	1	1001.00426.00	FRONT COVER, CBS-1221	
27	12	1082.00017.00	SCREW, TRUSS HD. PHIL. MACHINE, # 6-32 X 1/2 LG.	
28	1	1046.00003.00"	LABEL, CSD WARNING, 1.5" X 5.0	
29	1	1046.00035.00	LABEL, WARNING "TO REDUCE RISK OF ELECTRIC SHOCK OR FIRE"	
30	1	1402.00097.01	HARNESS, LOW AMP, CBS-1151-XV+, UL	
31	1	1086.00009.00	CLAMP, 3/4" MAX TUBE OD FLOW CONTROL	
32	1	1041.00033.00	BLACK EXTRACTOR PLUS LABEL, LASER ENGRAVED	
33	1	1086.00002.00	CLAMP, HOSE, SIZE "G" NYLON	
34	3	1086.00003.00	UNICLAMP, 15.9 HOSE OD CLAMP	
35	1	1082.00082.00	SCREW, PHILLIP HD., 8-32 THREAD	
36	1	1402.00113.00	WIRE HARNESS ADDITION, POWER SUPPLY GROUND	
37	1	B024230BN2	BREW BASKET ASSY, BLACK, 9-3/4" X 4-1/2", .230" DIA. HOLE, BROWN PLUG	
38	1	B025230B1	BREW BASKET ASSY, METAL, 9-3/4" X 4-1/2", .230" DIA HOLE, BLACK HANDLE	
39	1	B014218BN2	BB ASSY, 13" X 5", in .218" HOLE, BRN PLUG	
40	1	B003218B1	BREW BASKET ASSY, 13" X 5", .218 DIA HOLE, BLACK	
41	1	1086.00008.00	CONNECTOR, CLAMP, NON-METALLIC CABLE, 3/4"	
42	1	1063.00016.00	POWER CORD, 120VAC W/NEMA 5-15P PLUG	
43	1	1063.00030.00	CORD PWR, 16A/250VAC, EU1-16P PLUG, W/O CONNECTORS, CE	
44	1	1063.00034.00	CORD, POWER, 13A 250VAC, 2.5M LG., UK	
45	1	1402.00110.00	WIRE HARNESS, CBS-1221, HIGH AMP	
46	1	1104.00190.00	TANK ASSEMBLY, CBS/MBS-1221, 1.7kW/120VAC OR 3.2kW/240VAC	
46	1	1104.00203.00	TANK ASSEMBLY, CBS-1221, 3.2kW/240VAC	
46	1	1104.00204.00	TANK ASSEMBLY, CBS-1221, 1.7kW/120VAC	
47	1	1102.00219.00	ASSEMBLY, BB LOCKER, 24VDC	
48	1	1003.00259.00	BRACKET, BREW BASKET LOCK COVER	
49	2	1083.00011.00	WASHER, #8 SCREW SIZE, INTERNAL TOOTH LOCK	
50	2	1084.00010.00	NUT, HEX, #6-32, UNDERSIZED, ZINC PLATED	
51	1	1052.00029.00	EMI FILTER, TWO LINE 20A, 120/250VAC	
52	2	1081.00061.00	STANDOFF, 1/4 HEX x 1 1/4 LG., #6-32 THREAD	

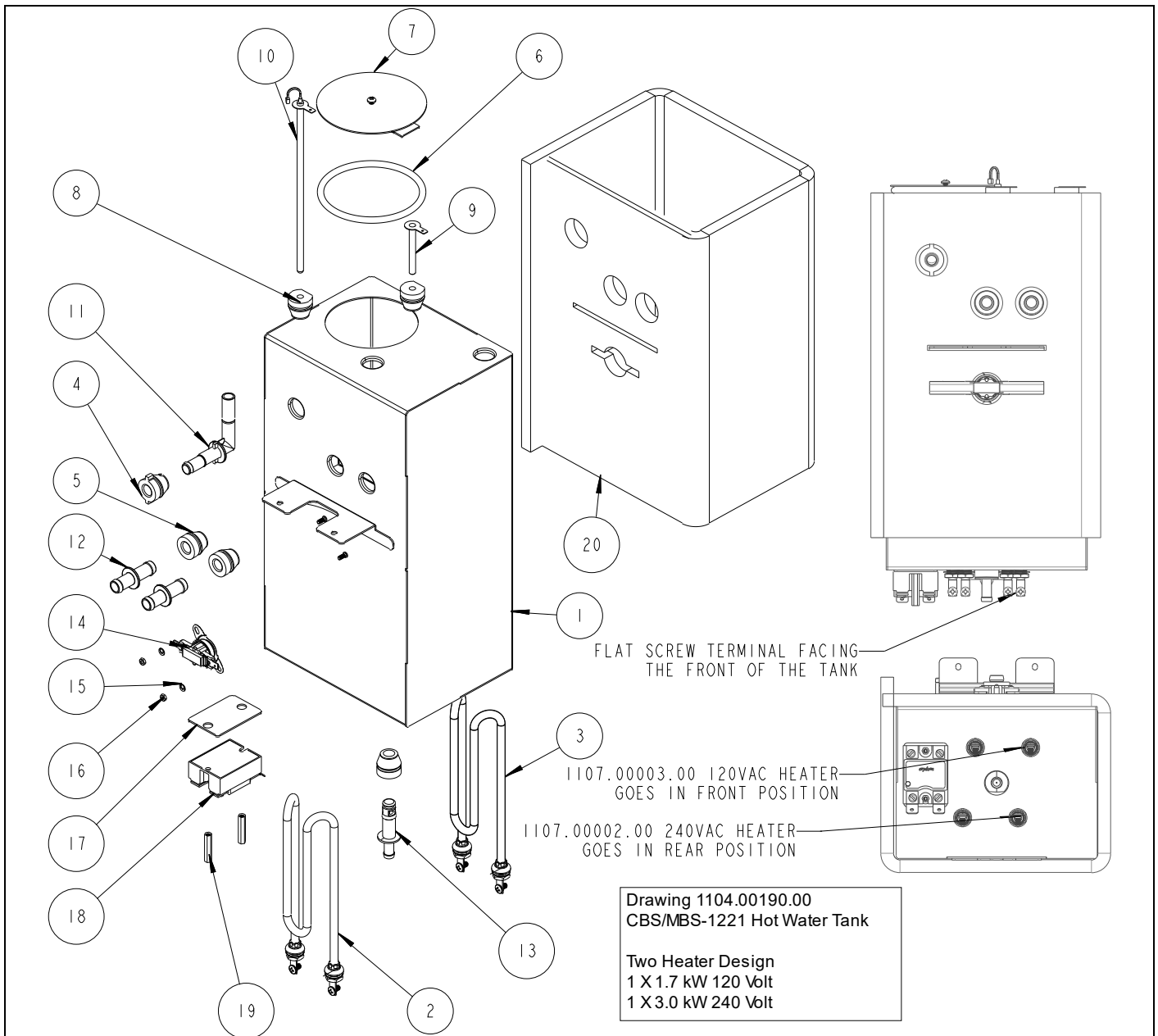

ITEM	Qty	PART NO	DESCRIPTION
Hot Water Tank CBS-1221 Drawing number 1104.00190.00			
1	1	1114.00167.00	WELDMENT, TANK, CBS-1221, 2 HEATERS
2	1	1107.00003.00	HEATER ASSY, IMMERSION 1700W/120VAC
3	1	1107.00002.00	HEATER ASSY, IMMERSION 3000W/240VAC
4	1	1024.00111.00	GROMMET, SILICONE, W/ POSITION TABS
5	3	1024.00050.00	GROMMET, SILICONE, 11.4mm ID
6	1	1024.00007.00	O-RING, DASH #344, TANK COVER
7	1	1102.00207.00	TANK COVER ASSEMBLY, TBS-2121
8	3	1024.00062.00	GROMMET, SHORT, SILICONE, LEVEL AND TEMP PROBE
9	1	1112.00002.00	PROBE WELDMENT, WATER LEVEL 2.25" LG
10	1	1102.00161.00	PROBE ASSEMBLY, TEMP. AND LLC, 8" LONG
11	1	1023.00362.00	FITTING VENT, ELBOW, .375" X .375", SELF POSITIONING
12	2	1023.00167.00	FITTING, STRAIGHT, GROMMET, .500"
13	1	1023.00166.00	FITTING, COLD WATER INLET, GROMMET DESIGN
14	1	1053.00051.00	THERMOSTAT, SINGLE SHOT, 240V/25A
15	2	1083.00009.00	WASHER, #6 SCREW, INTL TOOTH LOCKWASHER
16	2	1084.00010.00	NUT, HEX, #6-32, UNDERSIZED, ZINC PLATED
17	1	1003.00140.00	ALUMINUM BRACKET FOR SSR
18	1	1052.00033.00	RELAY, SOLID STATE, 50A/480VAC, W/BUILD IN VARISTOR
19	2	1081.00042.00	STANDOFF, 1/4" HEX
20	1	1022.00112.00	TANK INSULATION, CBS-1221



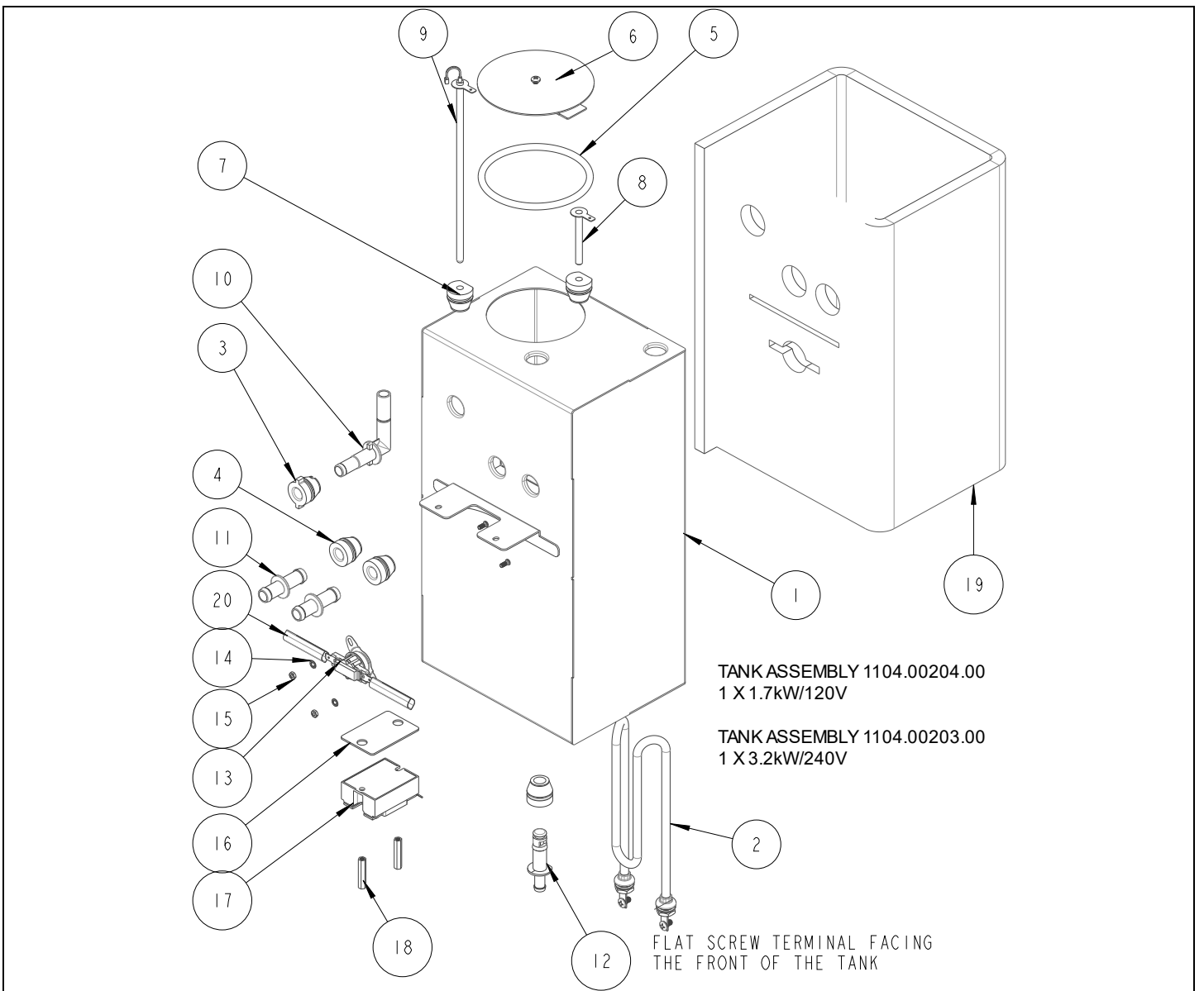

ITEM	Qty	PART NO	DESCRIPTION
Hot water tank drawing numbers 1104.00203.00 & 1104.00204.00			
1	1	1114.00173.00	WELDMENT, TANK, CBS/MBS-1221, ONE HEATER
2	1	1107.00002.00	HEATER ASSY, IMMERSION 3000W/240VAC (1104.00203.00)
2	1	1107.00003.00	HEATER ASSY, IMMERSION 1700W/120VAC (1103.00304.00)
3	1	1024.00111.00	GROMMET, SILICONE, W/ POSITION TABS
4	3	1024.00050.00	GROMMET, SILICONE, 11.4mm ID
5	1	1024.00007.00	O-RING, DASH #344, TANK COVER
6	1	1102.00207.00	TANK COVER ASSEMBLY, TBS-2121
7	2	1024.00062.00	GROMMET, SHORT, SILICONE, LEVEL AND TEMP PROBE
8	1	1112.00002.00	PROBE WELDMENT, WATER LEVEL 2.25" LG
9	1	1102.00161.00	PROBE ASSEMBLY, TEMP. AND LLC, 8" LONG
10	1	1023.00362.00	FITTING VENT, ELBOW, .375" X .375", SELF POSITIONING
11	2	1023.00167.00	FITTING, STRAIGHT, GROMMET, .500"
12	1	1023.00166.00	FITTING, COLD WATER INLET, GROMMET DESIGN
13	1	1053.00051.00	THERMOSTAT, SINGLE SHOT, 240V/25A
14	2	1083.00009.00	WASHER, #6 SCREW, INTL TOOTH LOCKWASHER
15	2	1084.00010.00	NUT, HEX, #6-32, UNDERSIZED, ZINC PLATED
16	1	1003.00140.00	ALUMINUM BRACKET FOR SSR
17	1	1052.00033.00	RELAY, SOLID STATE, 50A/480VAC, W/BUILD IN VARISTOR
18	2	1081.00042.00	STANDOFF, 1/4" HEX
19	1	1022.00112.00	TANK INSULATION, CBS-1221
20	2	1022.00032.00	SLEEVE, Ø.50 x 2.0" LG. x 1.50" SLOT

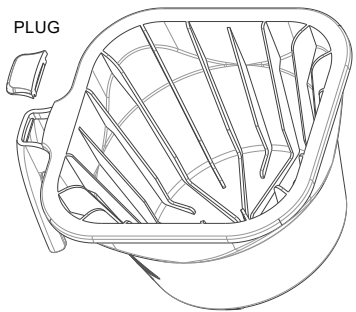

Brew Basket Parts

 <p>PLUG</p>	Part Number B014218BN2 Large Plastic Brew Basket	
	1023.00195.00	BROWN PLUG, BB HANDLE (STANDARD)
	1023.00194.00	BLACK PLUG, BB HANDLE (OPTIONAL)
	1023.00190.00	RED PLUG, BB HANDLE (OPTIONAL)
	1023.00191.00	GREEN PLUG, BB HANDLE (OPTIONAL)
	1023.00192.00	ORANGE PLUG, BB HANDLE (OPTIONAL)
	1023.00180.00	BLUE PLUG, BB HANDLE (OPTIONAL)

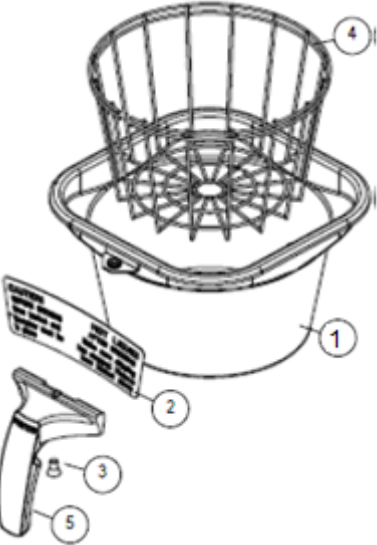
	Part Number B003218B1 Large Stainless Steel Brew Basket			
	Ref#	Qty	Part Number	Description
			B003218B1	Complete Stainless Steel Brew Basket
	1	1	1112.00128.00	BB WELDMENT 13" X 5", .218 DIA HOLE
	2	1	1046.00025.00	BREW BASKET WARNING LABEL
	3	1	1082.00040.00	SCREW, 1/4-20 X .5, FL HD, PH., W/NYLN
	4	1	1009.00006.00	WIRE BASKET
	5	1	1102.00064.00	HANDLE W/MAGNET ASY, BLACK
	Optional colored handle		1102.00065.00	HANDLE W/MAGNET ASY, RED
	Optional colored handle		1102.00066.00	HANDLE W/MAGNET ASY, GREEN
Optional colored handle		1102.00067.00	HANDLE W/MAGNET ASY, ORANGE	

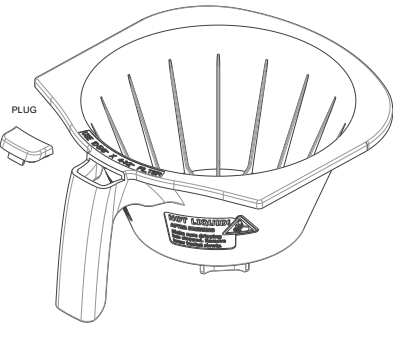
 <p>PLUG</p>	Part Number B024230BN2 Standard Plastic Brew Basket	
	Part Number	Description
	B024230BN2	Complete Standard Plastic Brew Basket
	1023.00359.00	PLUG, FOR AIR POT BREW BASKET ONLY, BROWN

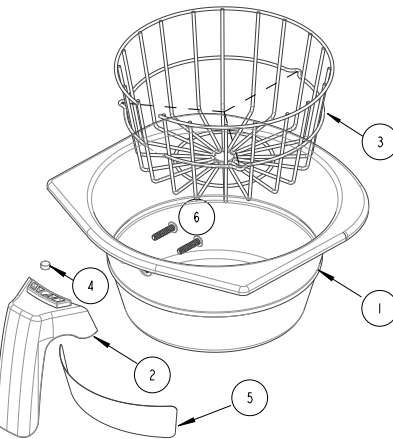
	Part Number B025230B1 Standard Stainless Steel Brew Basket			
	Ref	Qty	Part Number	Description
			B025230B1	Complete Stainless Steel Brew Basket
	1	1	1004.00053.00	BREW CONE, CBS-1221, 8" W/ .230" HOLE
	2	1	1023.00358.00	HANDLE, BREW BASKET,
	3	1	1009.00014.00	WIRE BASKET, CBS-1221, 8" BREW BASKET
	4	1	1057.00016.00	MAGNET, NEODYMIUM, 25"OD x .125"THK.
	5	1	1046.00061.00	LABEL, BREW BASKET WARNING, AIR POT
6	2	1082.00123.00	SCREW, ROUND HD. PHIL.	

Labels and warnings for hot beverage equipment

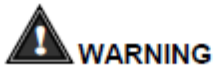

All electrical connections must be in accordance with local electrical codes and any other applicable codes. If the supply cord is damaged, it must be replaced by the manufacturer, its service agent, or similarly qualified persons in order to avoid a hazard.

To prevent an electric shock hazard this device must be bonded to equipment in close proximity with an equipotential bonding conductor. This device is equipped with a bonding lug for this purpose and is marked with the following symbol



	WARNING To reduce risk of electric shock or fire.
	FETCO® Hot Beverage Equipment is for commercial use only.
	Do not remove or open cover. No user serviceable parts inside. Refer installation and service to qualified personnel.
	Caution, disconnect from power supply before servicing.
	GROUND: National Electrical Code requires separate grounding wire.
	Use dedicated circuit with capacity rated by local code or National Electrical Code for the current draw of this equipment. Check serial number plate on right side for power requirements.
	Locate unit away from source of heat. Do not install or use near combustibles.
	THIS APPLIANCE IS ENERGIZED WHENEVER IT IS CONNECTED TO A POWER SOURCE
	FAILURE TO COMPLY RISKS EQUIPMENT DAMAGE, PROPERTY DAMAGE, FIRE, OR SHOCK HAZARD
Notice	This equipment must be installed with a backflow protection device to comply with federal, state or local municipality codes.
Notice	Read the user guide before installing and operating this unit.

For BACK PANEL of equipment (1046.00035.00)

Wiring Diagram

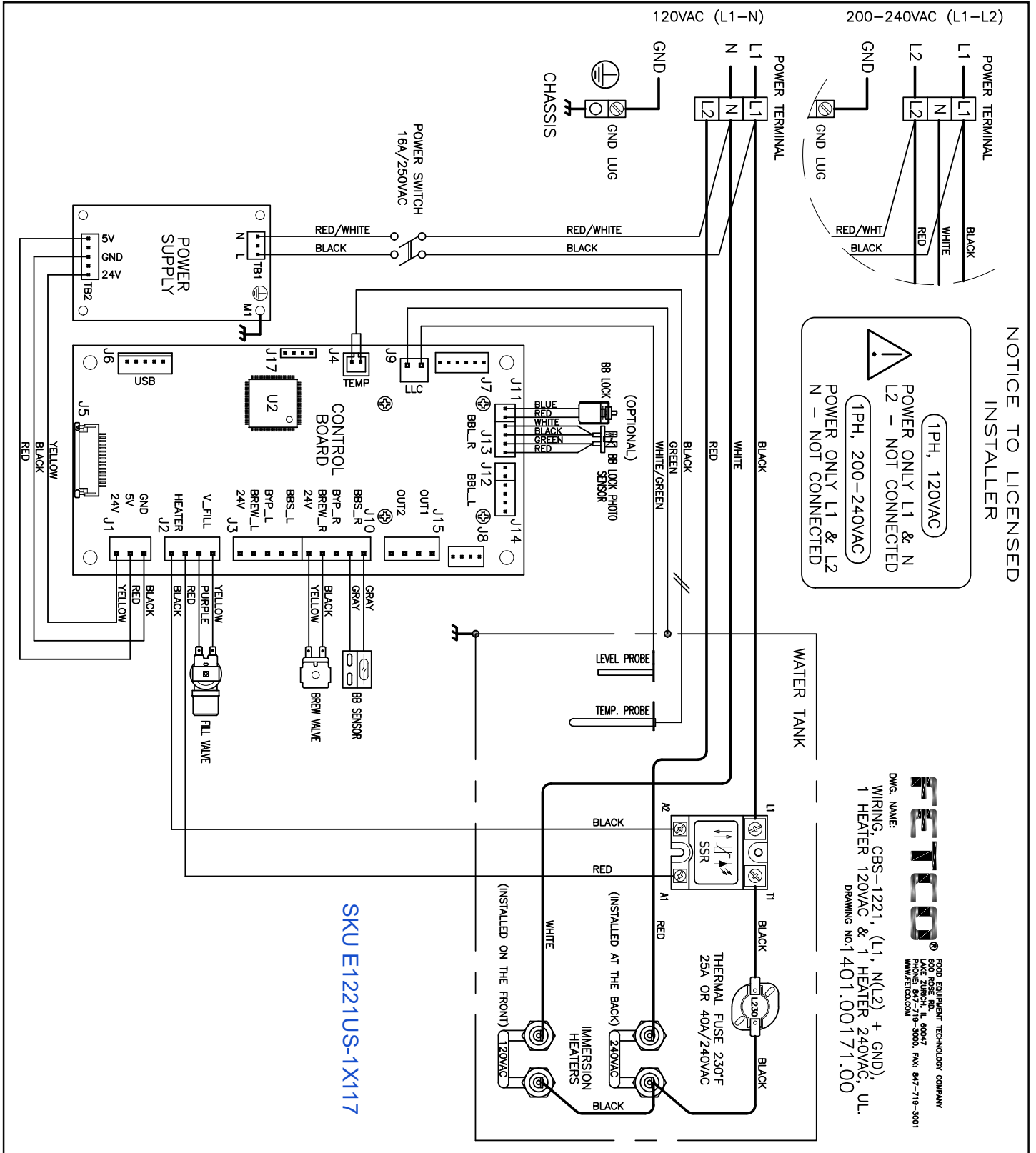

FETCO
 FOOD EQUIPMENT TECHNOLOGY COMPANY
 600 ROSE RD. IL 60047
 GLENVIEW, IL 60047
 PHONE: 847-719-3000, FAX: 847-719-3001
 WWW.FETCO.COM

DWG. NAME:
 WIRING, CBS-1221, (L1, N(L2) + GND),
 1 HEATER 120VAC & 1 HEATER 240VAC, UL.
 DRAWING NO. 1401.00171.00

