

VEVOR

Affordable. Reliable. Home Improvement.

OVER THE TABLE ROD STAND

MODEL:ALL SIZE

Technical Support and E-Warranty Certificate
www.vevor.com/support

VEVOR

Affordable. Reliable. Home Improvement.

OVER THE TABLE ROD STAND

MODEL:ALL SIZE

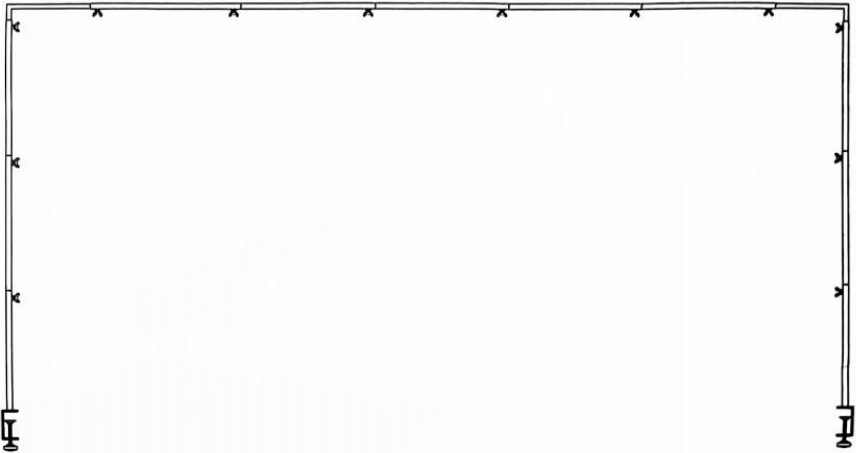

This is the original instruction, please read all manual instructions carefully before operating. VEVOR reserves a clear interpretation of our user manual. The appearance of the product shall be subject to the product you received. Please forgive us that we won't inform you again if there are any technology or software updates on our product.

Parts List

Please check that the parts are complete before installation. Contact us if you have damaged or missing components.

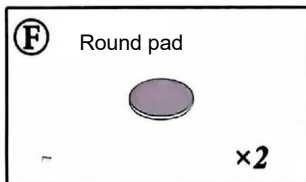
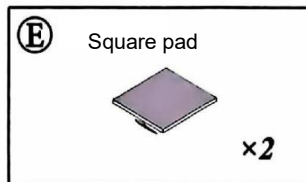
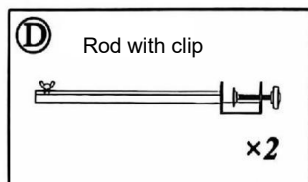
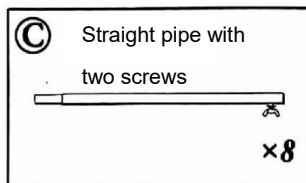
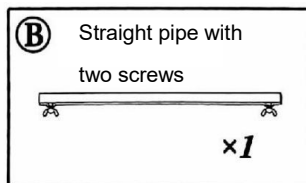
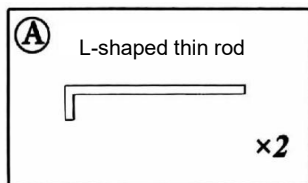
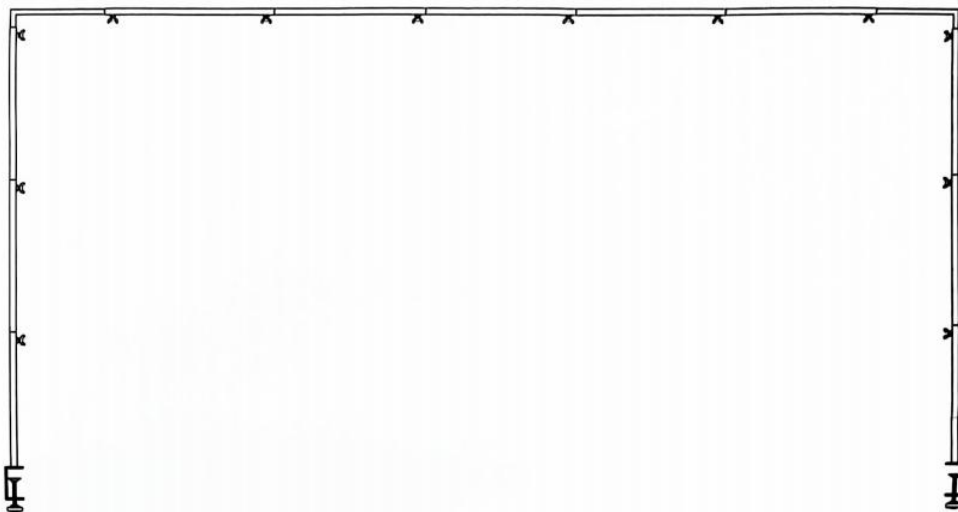
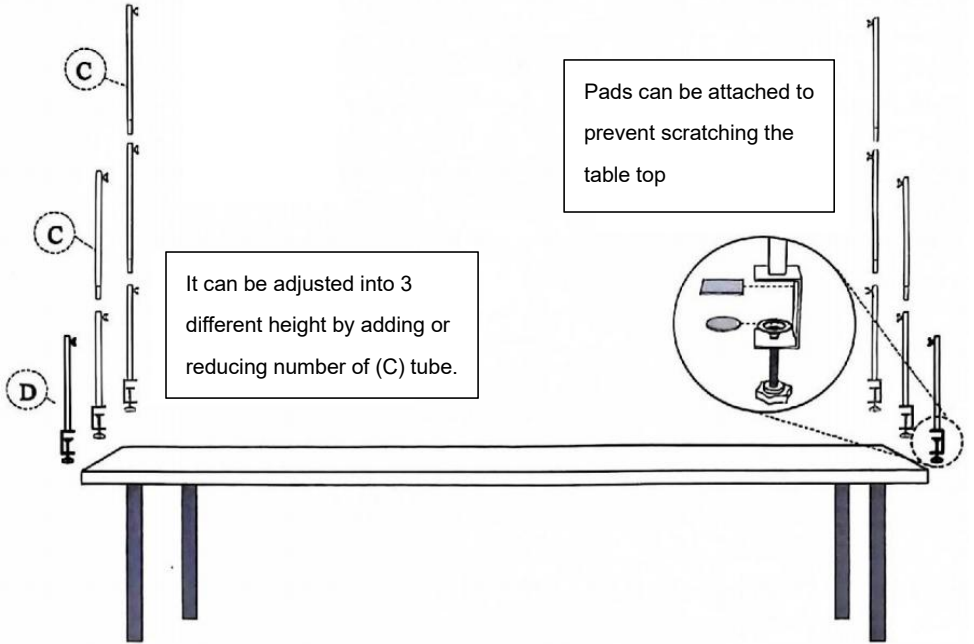

TABLE ARCH

INSTALLATION INSTRUCTIONS



STEP 1



Install two rods with clips(D) first, tighten the screws, and clamp the table top.

STEP 2

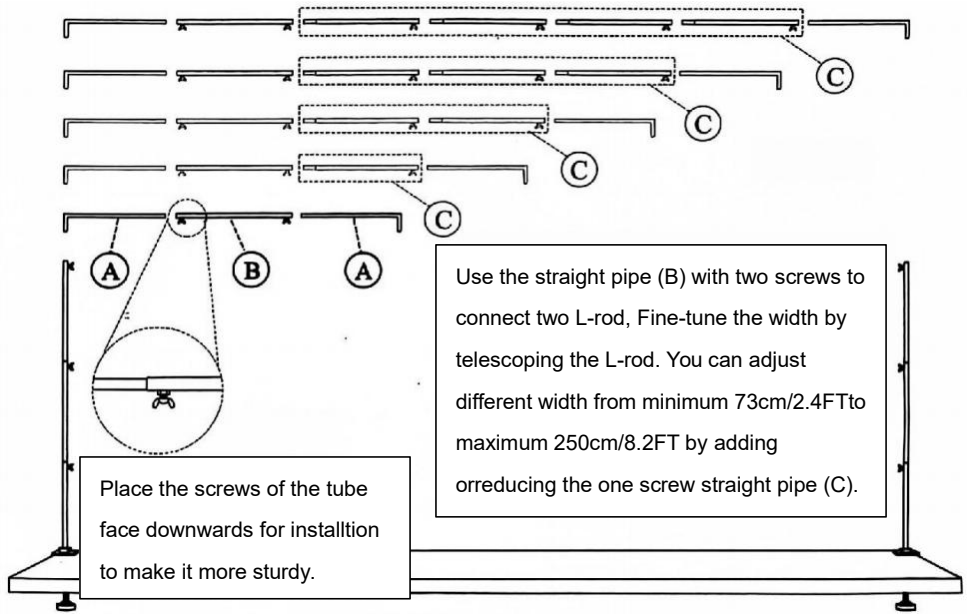

Manufacturer: Shanghaimuxinmuyeyouxiangongsi

Address: Shuangchenglu 803nong11hao1602A-1609shi, baoshanqu, shanghai 200000 CN.

Imported to AUS: SIHAO PTY LTD. 1 ROKEVA STREETEASTWOOD NSW 2122 Australia

Imported to USA: Sanven Technology Ltd. Suite 250, 9166 Anaheim Place, Rancho Cucamonga, CA 91730

UK	REP
-----------	------------

YH CONSULTING LIMITED. C/O YH Consulting Limited Office 147, Centurion House, London Road, Staines-upon-Thames, Surrey, TW18 4AX

EC	REP
-----------	------------

E-CrossStu GmbH
Mainzer Landstr.69,
60329 Frankfurt am Main.



Technical Support and E-Warranty Certificate
www.vevor.com/support

VEVOR

Affordable. Reliable. Home Improvement.

SUPPORTO PER CANNA DA TAVOLO

MODELLO:TUTTE LE TAGLIA

Supporto tecnico e certificato di garanzia elettronica www.vevor.com/

support

VEVOR

Affordable. Reliable. Home Improvement.

ASTA SOPRA IL TAVOLO IN PIEDI

MODELLO:TUTTE LE TAGLIA

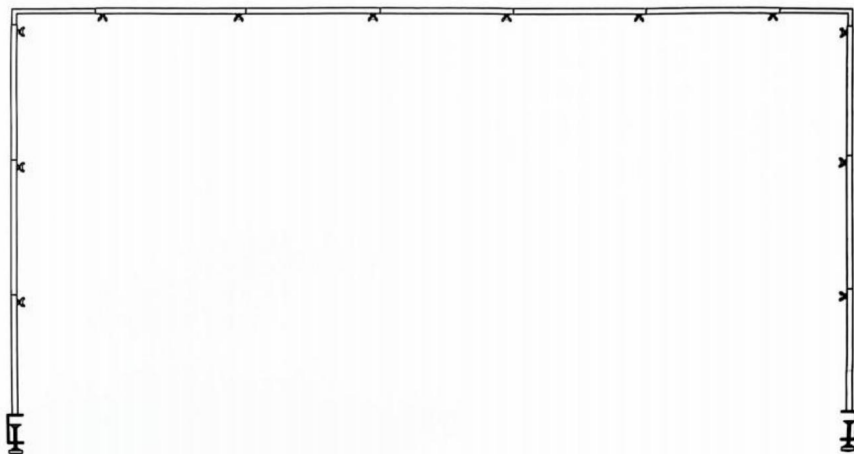

Questa è l'istruzione originale, si prega di leggere attentamente tutte le istruzioni del manuale prima di utilizzare. VEVOR si riserva una chiara interpretazione del nostro manuale utente. L'aspetto del prodotto sarà soggetto al prodotto ricevuto. Vi preghiamo di perdonarci se non vi informeremo di nuovo se ci sono aggiornamenti tecnologici o software sul nostro prodotto.

Elenco delle parti

Si prega di controllare che le parti siano complete prima dell'installazione. Contattateci se presentano componenti danneggiati o mancanti.

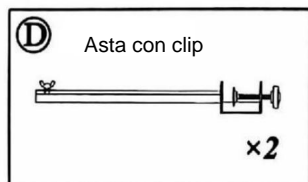
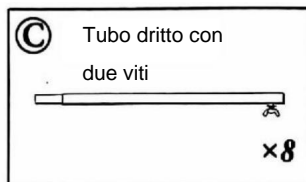
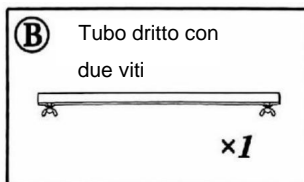
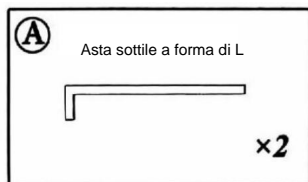

ARCO DA TAVOLO

ISTRUZIONI PER L'INSTALLAZIONE

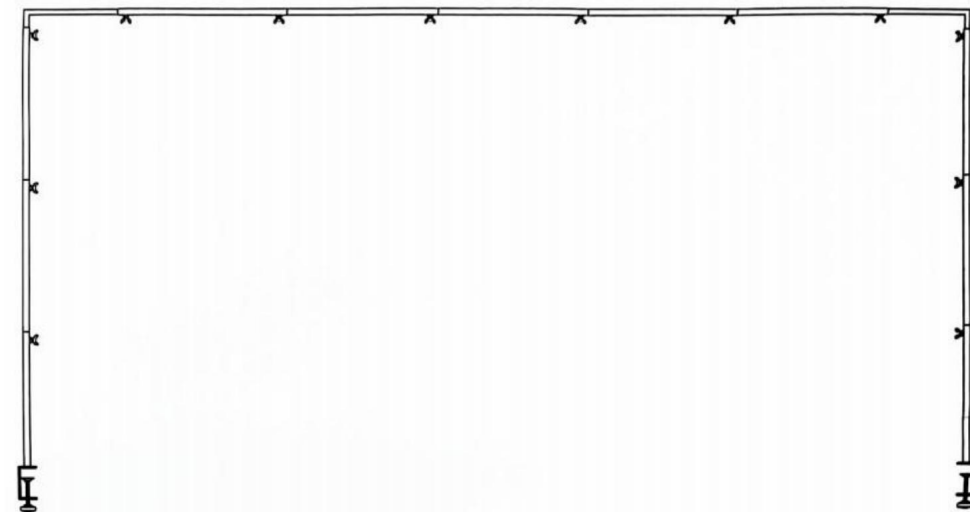

PASSO 1

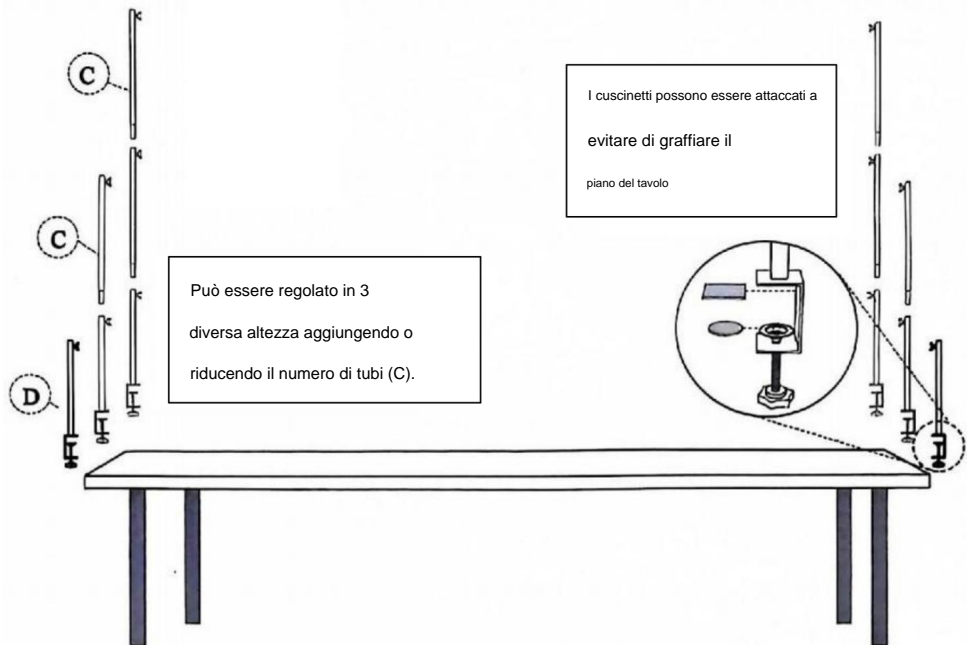

Per prima cosa installare due aste con clip (D), stringere le viti e fissare il piano del tavolo.

PASSO 2

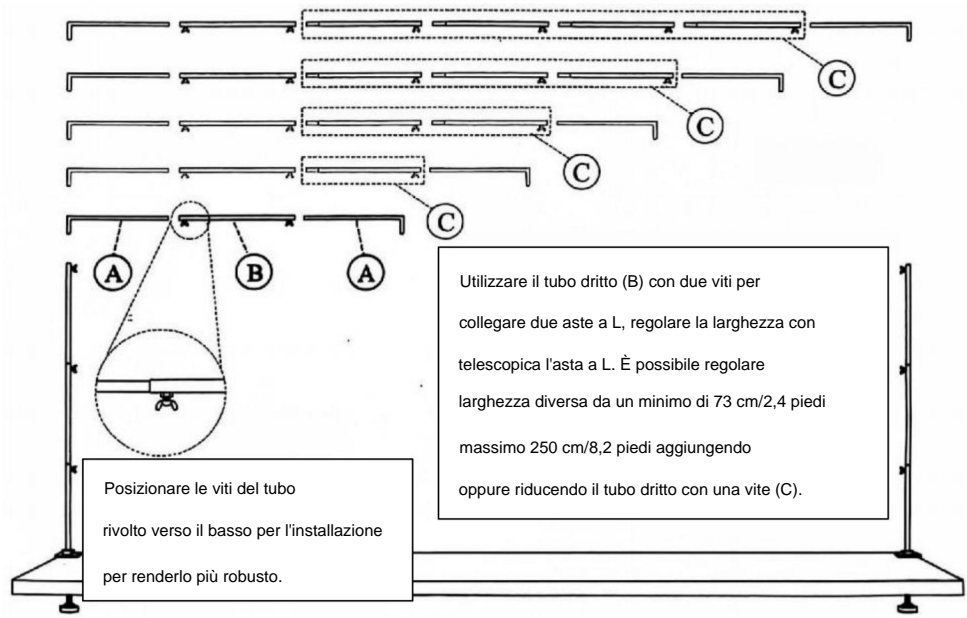

Produttore: Shanghaimuxinmuyeyouxiangongsi **Indirizzo:**

Shuangchenglu 803nong11hao1602A-1609shi, baoshanqu, shanghai 200000 CN.

Importato in AUS: SIHAO PTY LTD. 1 ROKEVA STREETEASTWOOD NSW 2122
Australia

Importato negli USA: Sanven Technology Ltd. Suite 250, 9166 Anaheim Place,
Rancho Cucamonga, CA 91730



YH CONSULTING LIMITED. C/O YH Consulting Limited
Ufficio 147, Centurion House, London Road, Staines-
upon-Thames, Surrey, TW18 4AX

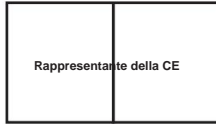

E-CrossStu GmbH
Mainzer Landstr.69,
60329 Francoforte sul Meno.



**Supporto tecnico e certificato di garanzia
elettronica www.vevor.com/support**

VEVOR

Affordable. Reliable. Home Improvement.

STOJAK NA DRAŻEK NAD STOŁEM

MODEL:WSZYSTKIE ROZMIARY

Wsparcie techniczne i certyfikat gwarancji elektronicznej www.vevor.com/

support

VEVOR

Affordable. Reliable. Home Improvement.

PRĘT NAD STOŁEM

PODSTAWKA

MODEL:WSZYSTKIE ROZMIARY

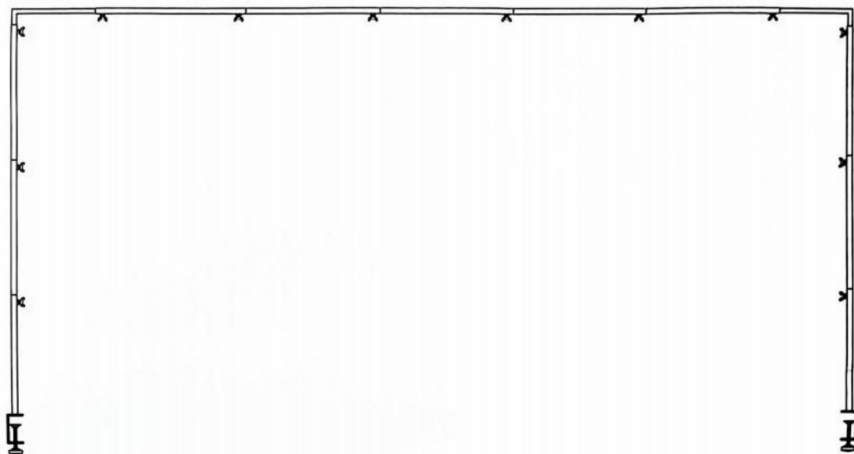

To jest oryginalna instrukcja, przed użyciem należy uważnie przeczytać wszystkie instrukcje. VEVOR zastrzega sobie jasną interpretację naszej instrukcji obsługi. Wygląd produktu będzie zależał od produktu, który otrzymałeś. Prosimy o wybaczenie, że nie poinformujemy Cię ponownie, jeśli w naszym produkcie pojawią się jakiegokolwiek aktualizacje technologiczne lub oprogramowania.

Lista części

Przed montażem sprawdź, czy części są kompletne. Skontaktuj się z nami, jeśli mają uszkodzone lub brakujące elementy.

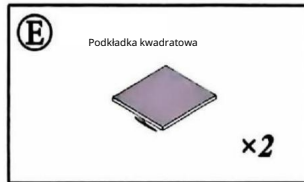
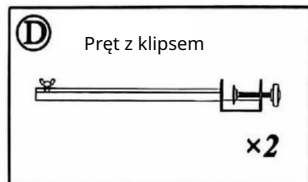
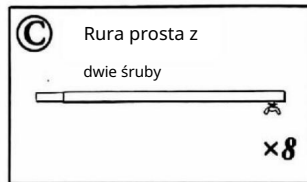
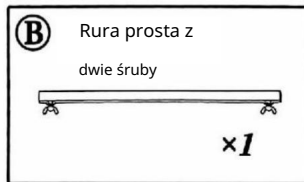
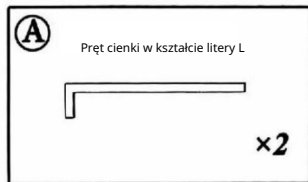

ŁUK STOŁOWY

INSTRUKCJA INSTALACJI

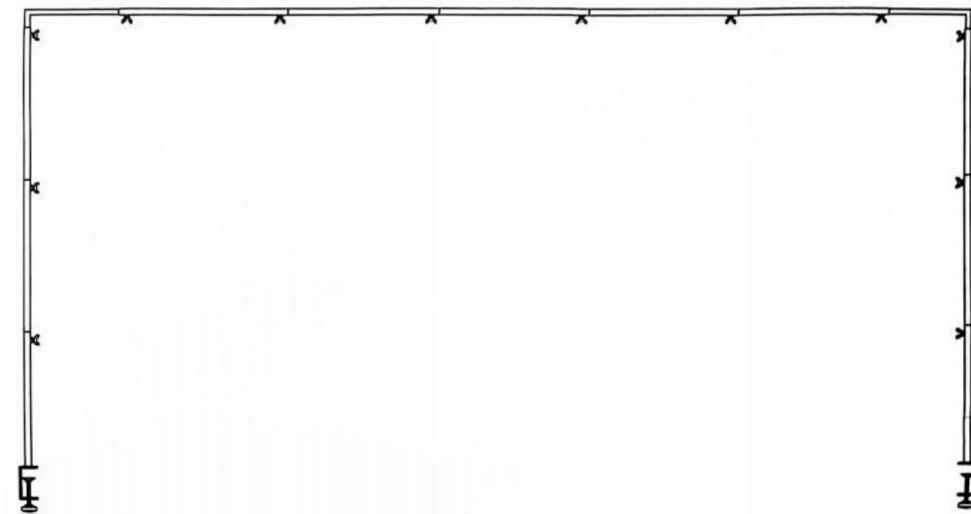

KROK 1

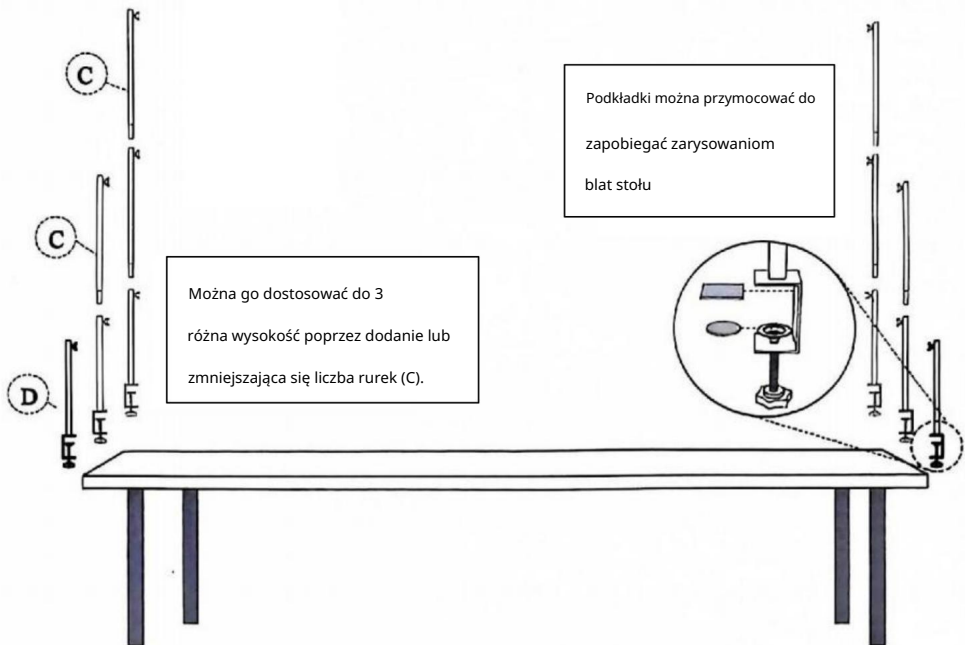

Najpierw zamontuj dwa pręty za pomocą klipsów (D), dokręć śruby i zamocuj blat stołu.

KROK 2

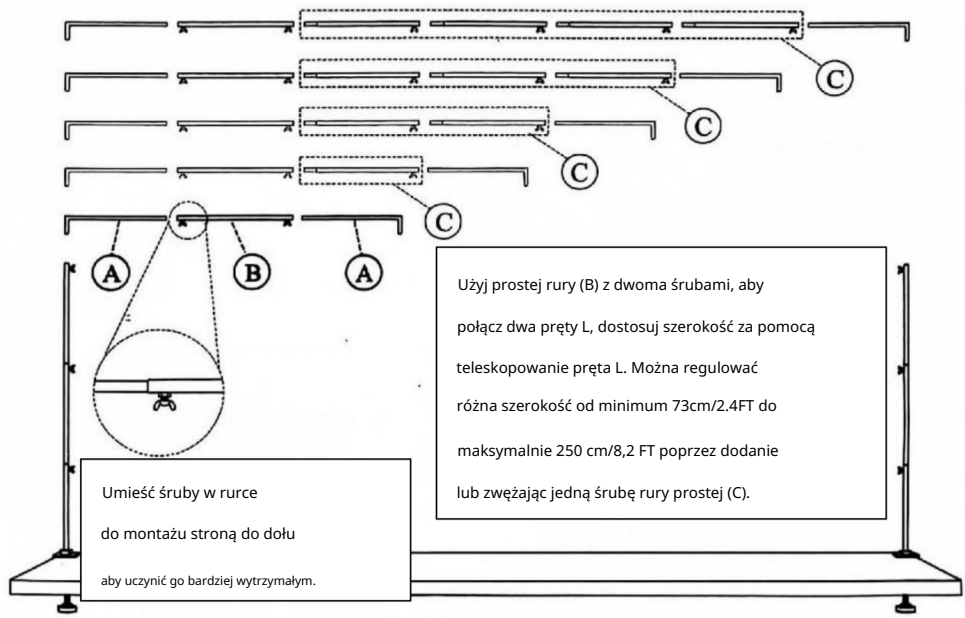

Producent: Shanghaimuxinmuyeyouxiangongsi Adres:

Shuangchenglu 803nong11hao1602A-1609shi, baoshanqu, szanghaj 200000 CN.

Importowane do AUS: SIHAO PTY LTD. 1 ROKEVA STREETEASTWOOD NSW 2122 Australia

Importowane do USA: Sanven Technology Ltd. Suite 250, 9166 Anaheim Place, Rancho Cucamonga, CA 91730

REP WIELKIEJ	BRYTANII
--------------	----------

YH CONSULTING LIMITED. C/O YH Consulting Limited Biuro
147, Centurion House, London Road, Staines-upon-
Thames, Surrey, TW18 4AX

Przedstawiciel UE	
-------------------	--

E-CrossStu GmbH
Mainzer Landstr.69,
60329 Frankfurt nad Menem.



Wsparcie techniczne i certyfikat gwarancji
elektronicznej www.vevor.com/support

VEVOR

Affordable. Reliable. Home Improvement.

Über dem Tischstangenständer

MODELL: ALLE GRÖSSEN

Technischer Support und E-Garantie-Zertifikat www.vevor.com/

support

VEVOR

Affordable. Reliable. Home Improvement.

ÜBER DER TISCHSTANGE STAND

MODELL: ALLE GRÖSSEN

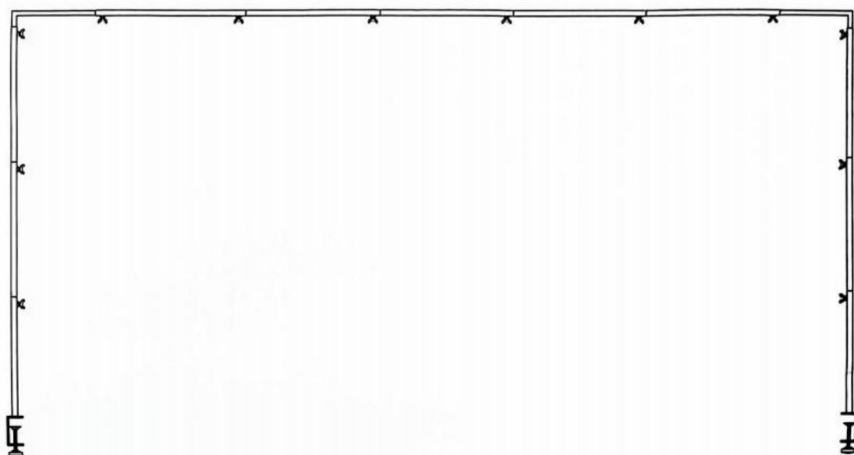

Dies ist die Originalanleitung. Bitte lesen Sie alle Anweisungen sorgfältig durch, bevor Sie das Gerät in Betrieb nehmen. VEVOR behält sich das Recht vor, die Bedienungsanleitung klar und deutlich zu interpretieren. Das Aussehen des Produkts hängt vom gelieferten Produkt ab. Bitte haben Sie Verständnis dafür, dass wir Sie nicht erneut über Technologie- oder Software-Updates informieren.

Teileliste

Bitte überprüfen Sie vor der Installation die Vollständigkeit der Teile. Kontaktieren Sie uns, wenn Sie haben beschädigte oder fehlende Komponenten.

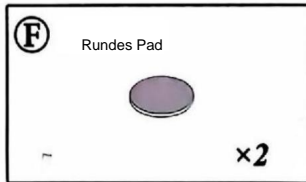
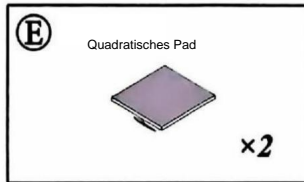
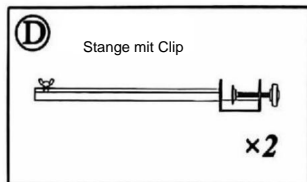
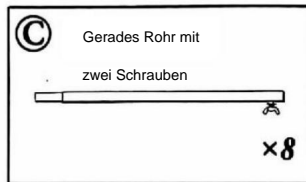
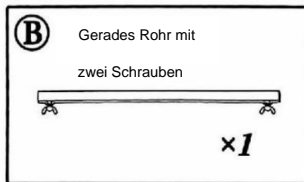
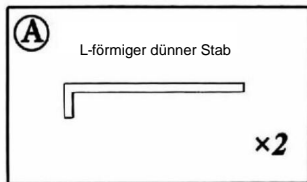

TISCHBOGEN

INSTALLATIONSANLEITUNG

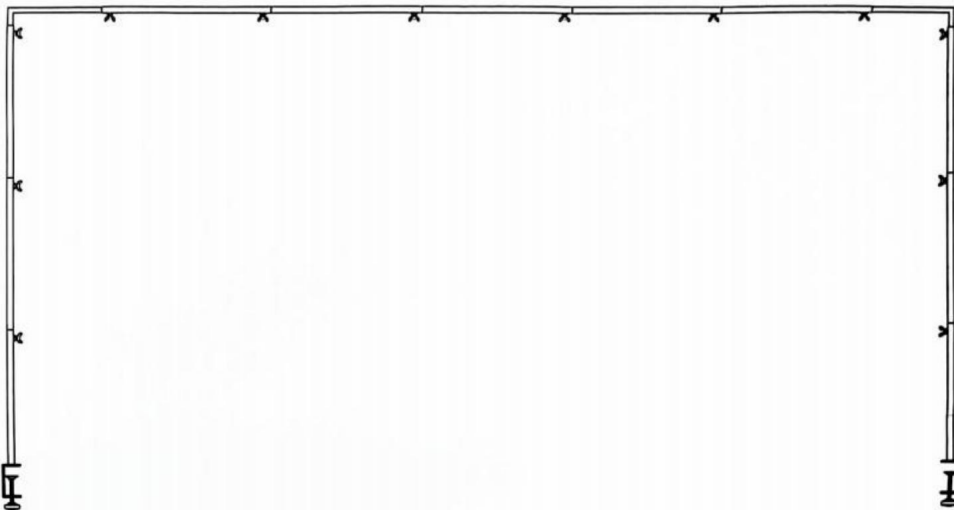

SCHRITT 1

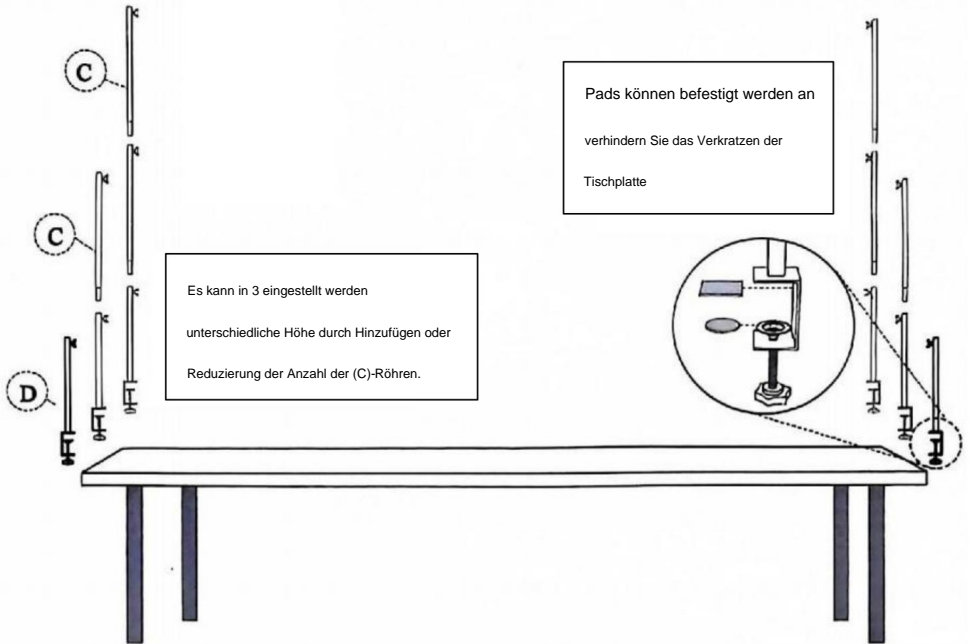

Montieren Sie zunächst zwei Stangen mit Klammern (D), ziehen Sie die Schrauben fest und klemmen Sie die Tischplatte fest.

SCHRITT 2

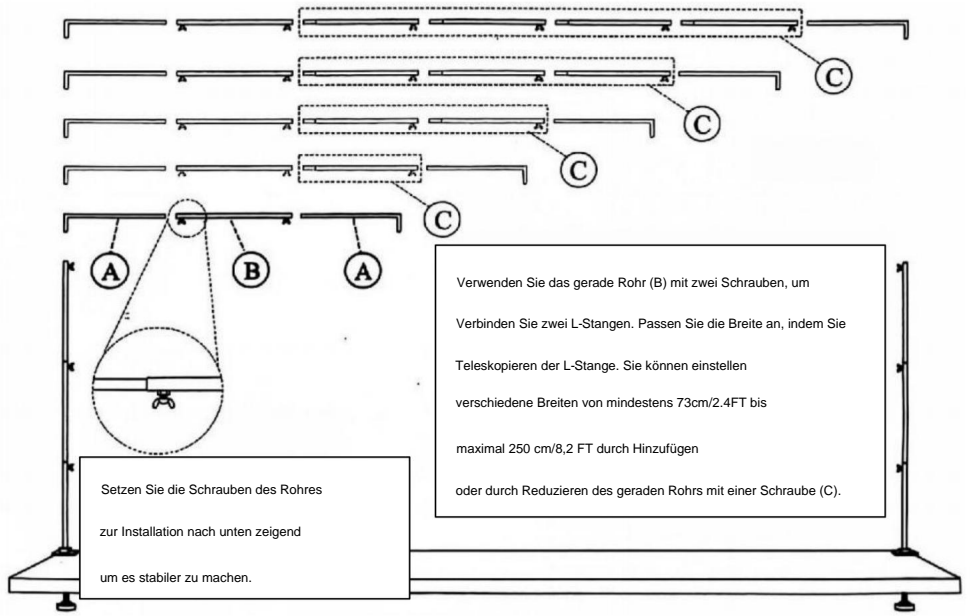

Hersteller: Shanghaimuxinmuyeyouxiangongsi **Adresse:**

Shuangchenglu 803nong11hao1602A-1609shi, baoshanqu, Shanghai 200000 CN.

Importiert nach AUS: SIHAO PTY LTD. 1 ROKEVA STREETEASTWOOD NSW 2122
Australien

Importiert in die USA: Sanven Technology Ltd. Suite 250, 9166 Anaheim Place,
Rancho Cucamonga, CA 91730

Britische Republik	
---------------------------	--

YH CONSULTING LIMITED. C/O YH Consulting Limited,
Büro 147, Centurion House, London Road, Staines-upon-
Thames, Surrey, TW18 4AX

EG-Vertreter	
---------------------	--

E-CrossStu GmbH
Mainzer Landstr.69,
60329 Frankfurt am Main.



Technischer Support und E-Garantie-Zertifikat
www.vevor.com/support

VEVOR

Affordable. Reliable. Home Improvement.

SUPPORT DE TIGE AU-DESSUS DE LA TABLE

MODÈLE : TOUTES TAILLES

Assistance technique et certificat de garantie électronique www.vevor.com/

support

VEVOR

Affordable. Reliable. Home Improvement.

TIGE AU-DESSUS DE LA TABLE
RESTER

MODÈLE : TOUTES TAILLES

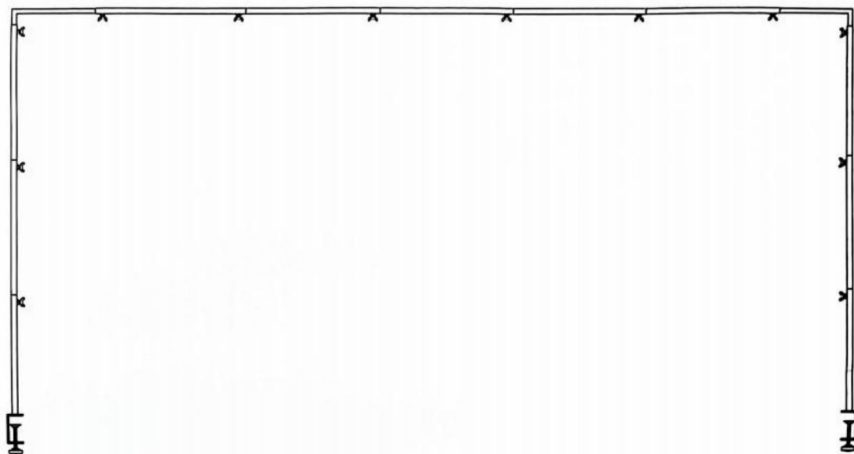

Ceci est le mode d'emploi d'origine. Veuillez lire attentivement toutes les instructions du manuel avant utilisation. VEVOR se réserve le droit d'interpréter clairement ce manuel d'utilisation. L'apparence du produit dépend du produit que vous avez reçu. Veuillez nous excuser pour le retard dans la publication de toute mise à jour technologique ou logicielle concernant notre produit.

Liste des pièces

Veillez vérifier que les pièces sont complètes avant l'installation. Contactez-nous si nécessaire.
avoir des composants endommagés ou manquants.

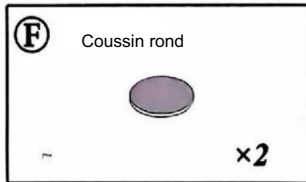
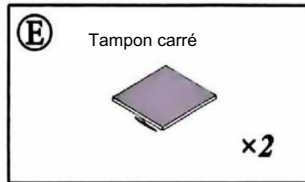
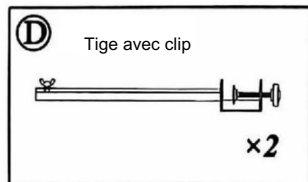
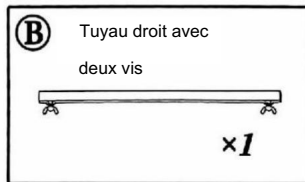
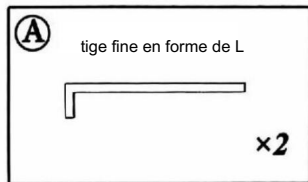

ARCHE DE TABLE

INSTRUCTIONS D'INSTALLATION

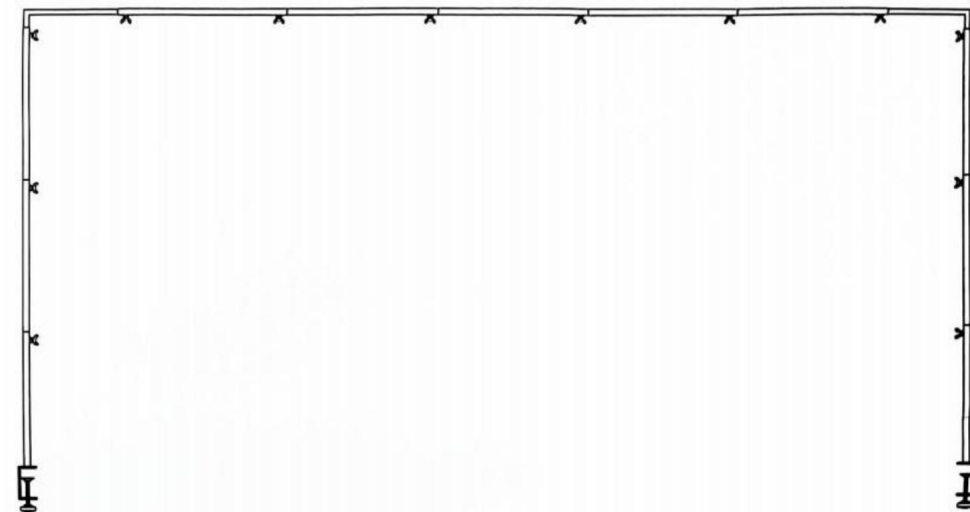

ÉTAPE 1

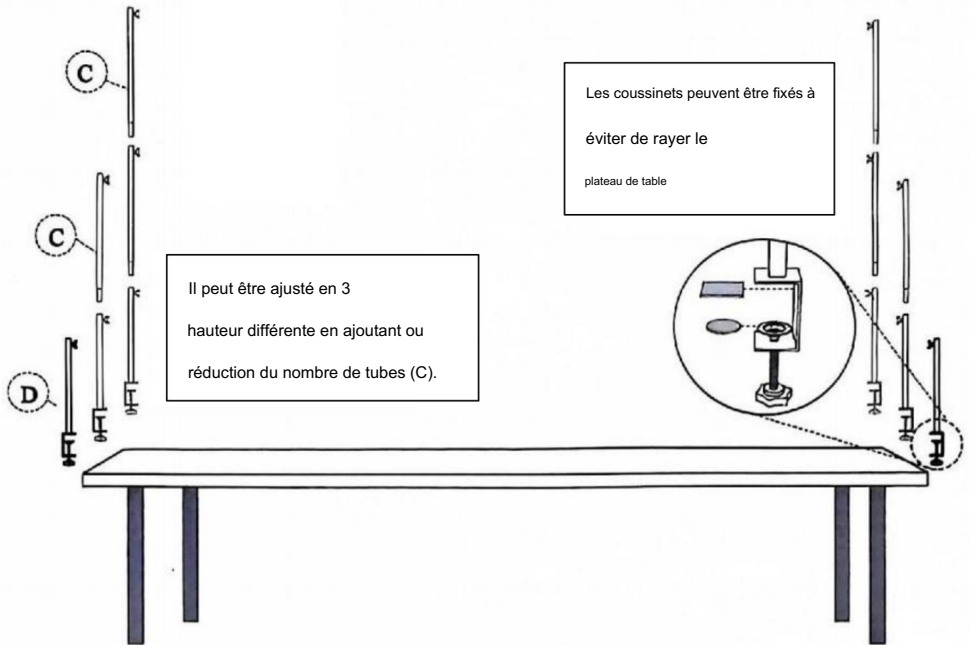

Installez d'abord deux tiges avec des clips (D), serrez les vis et fixez le plateau de la table.

ÉTAPE 2

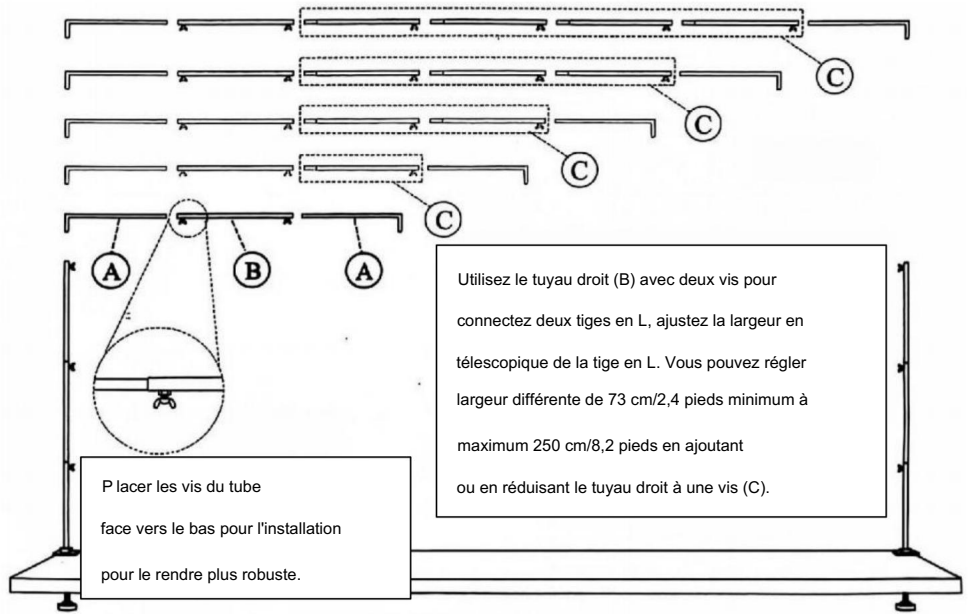

Fabricant : Shanghaimuxinmuyeyouxiangongsi Adresse :
Shuangchenglu 803nong11hao1602A-1609shi, baoshanqu, shanghai 200000 CN.

Importé en Australie : SIHAO PTY LTD. 1 ROKEVA STREET, ASTWOOD NSW 2122,
Australie

Importé aux États-Unis : Sanven Technology Ltd. Suite 250, 9166 Anaheim Place,
Rancho Cucamonga, CA 91730



YH CONSULTING LIMITED. A/S YH Consulting Limited,
bureau 147, Centurion House, London Road, Staines-
upon-Thames, Surrey, TW18 4AX



E-CrossStu GmbH
Mainzer Landstr.69,
60329 Francfort-sur-le-Main.



Assistance technique et certificat de garantie
électronique www.vevor.com/support

VEVOR

Affordable. Reliable. Home Improvement.

OVER DE TAFELSTANG STANDAARD

MODEL: ALLE MATEN

Technische ondersteuning en e-garantiecertificaat

www.vevor.com/support

VEVOR

Affordable. Reliable. Home Improvement.

OVER DE TAFELSTANG

STELLAGE

MODEL: ALLE MATEN

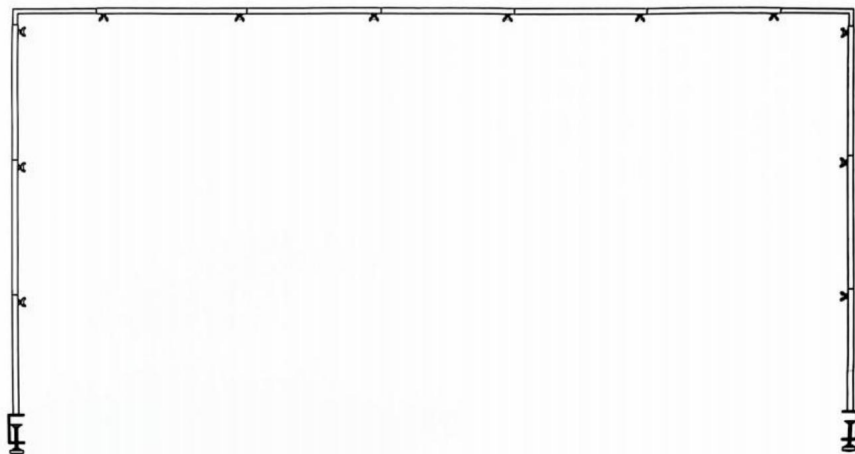

Dit is de originele instructie, lees alle handleidingen zorgvuldig door voordat u het product gebruikt. VEVOR behoudt zich een duidelijke interpretatie van onze gebruikershandleiding voor. Het uiterlijk van het product is afhankelijk van het product dat u hebt ontvangen. Vergeef ons dat we u niet opnieuw zullen informeren als er technologie- of software-updates voor ons product zijn.

Onderdelenlijst

Controleer of de onderdelen compleet zijn voor de installatie. Neem contact met ons op als u beschadigde of ontbrekende onderdelen hebben.

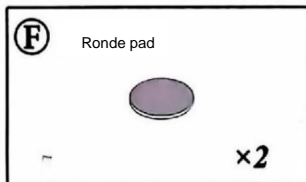
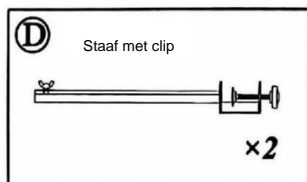
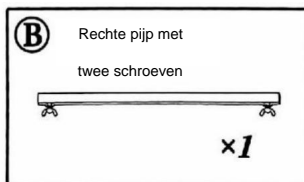
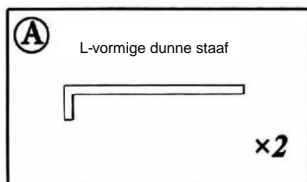

TAFELBOOG

INSTALLATIE-INSTRUCTIES

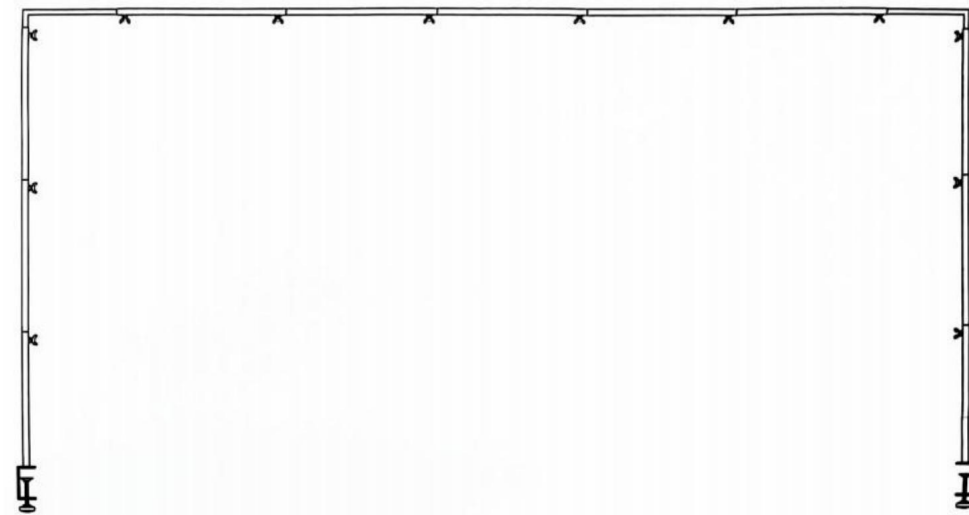

STAP 1

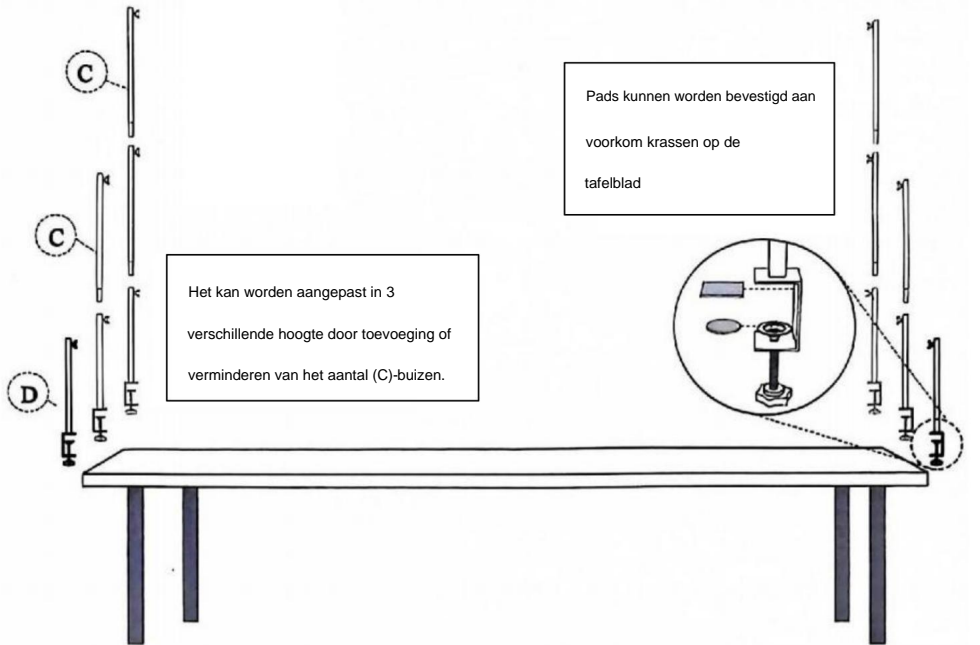

Plaats eerst de twee stangen met clips (D), draai de schroeven vast en klem het tafelblad vast.

STAP 2

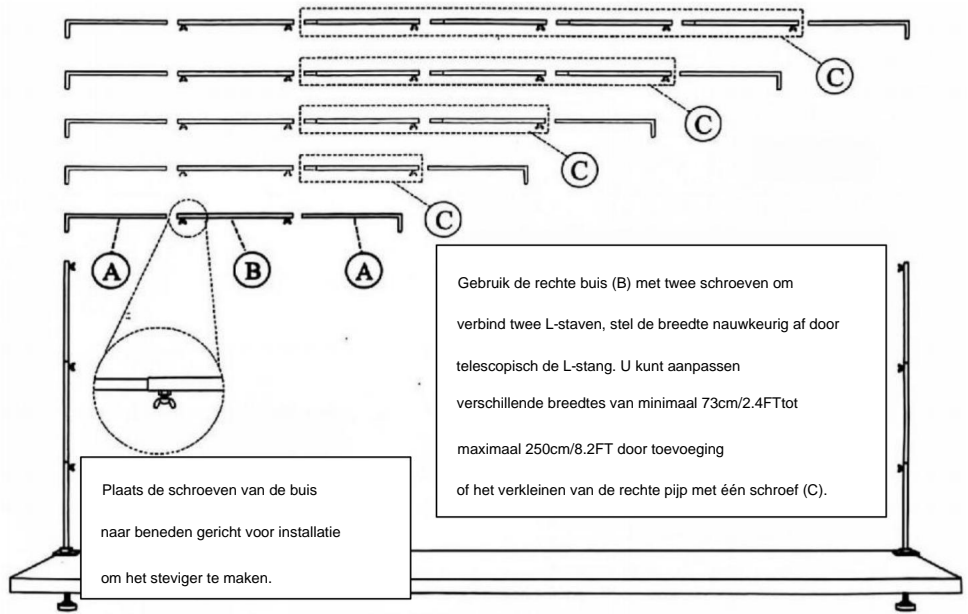

Fabrikant: Shanghaimuxinmuyeyouxiangongsi **Adres:**

Shuangchenglu 803nong11hao1602A-1609shi, baoshanqu, shanghai 200000 CN.

Geïmporteerd naar AUS: SIHAO PTY LTD. 1 ROKEVA STREETEASTWOOD NSW
2122 Australië

Geïmporteerd naar de VS: Sanven Technology Ltd. Suite 250, 9166 Anaheim Place,
Rancho Cucamonga, CA 91730



YH CONSULTING LIMITED. C/O YH Consulting Limited
Kantoor 147, Centurion House, London Road, Staines-
upon-Thames, Surrey, TW18 4AX



E-CrossStu GmbH
Mainzer Landstr.69,
60329 Frankfurt am Main.



**Technische ondersteuning en e-
garantiecertificaat www.vevor.com/support**

VEVOR

Affordable. Reliable. Home Improvement.

ÖVER BORDSSTÖVET

MODELL: ALLA STORLEKAR

Teknisk support och e-garanticertifikat [www.vevor.com/
support](http://www.vevor.com/support)

VEVOR

Affordable. Reliable. Home Improvement.

ÖVER BORDSSTAVEN
STÅ

MODELL: ALLA STORLEKAR

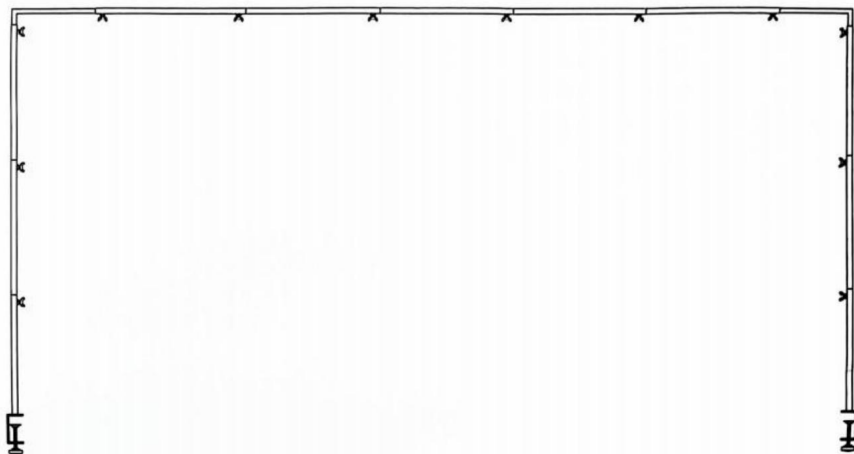

Detta är den ursprungliga instruktionen, läs alla instruktioner noggrant innan du använder den. VEVOR reserverar sig för en tydlig tolkning av vår användarmanual. Utseendet på produkten är beroende av den produkt du fått. Ursäkta oss att vi inte kommer att informera dig igen om det finns någon teknik eller mjukvaruuppdateringar på vår produkt.

Delarlista

Kontrollera att delarna är kompletta innan installation. Kontakta oss om du har skadade eller saknade komponenter.

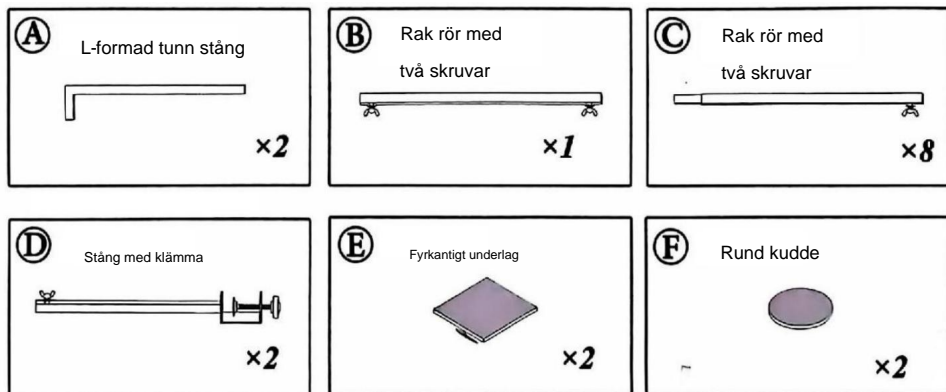

BORDSVÅG

INSTALLATIONSINSTRUKTIONER

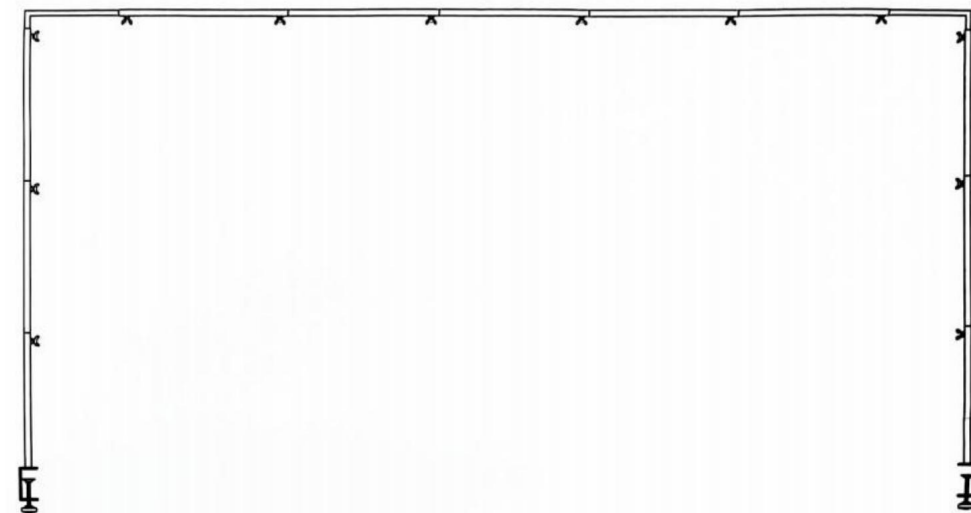

STEG 1

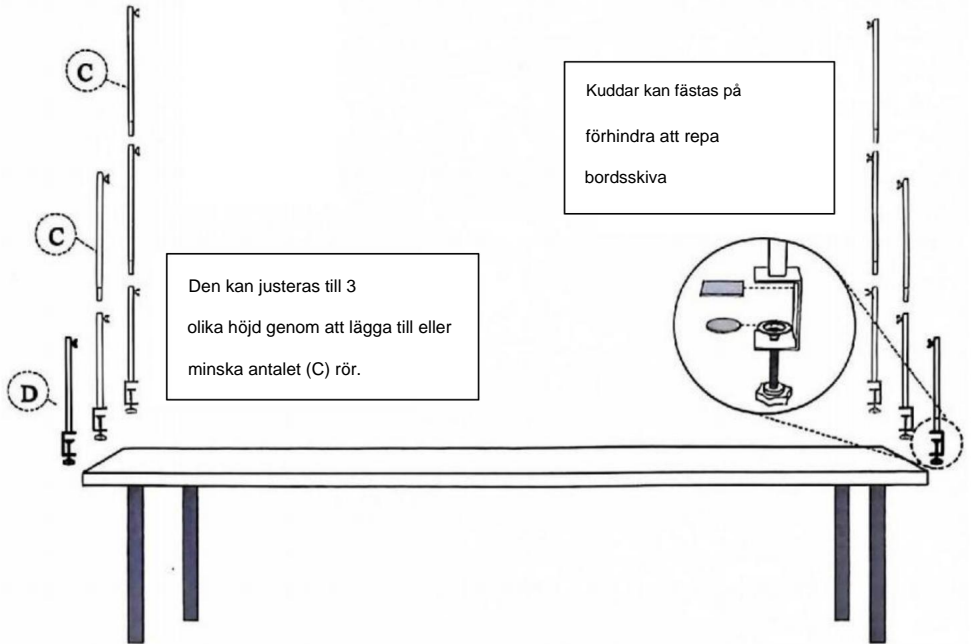

Montera två stänger med klämmor (D) först, dra åt skruvarna och klämma fast bordsskivan.

STEG 2

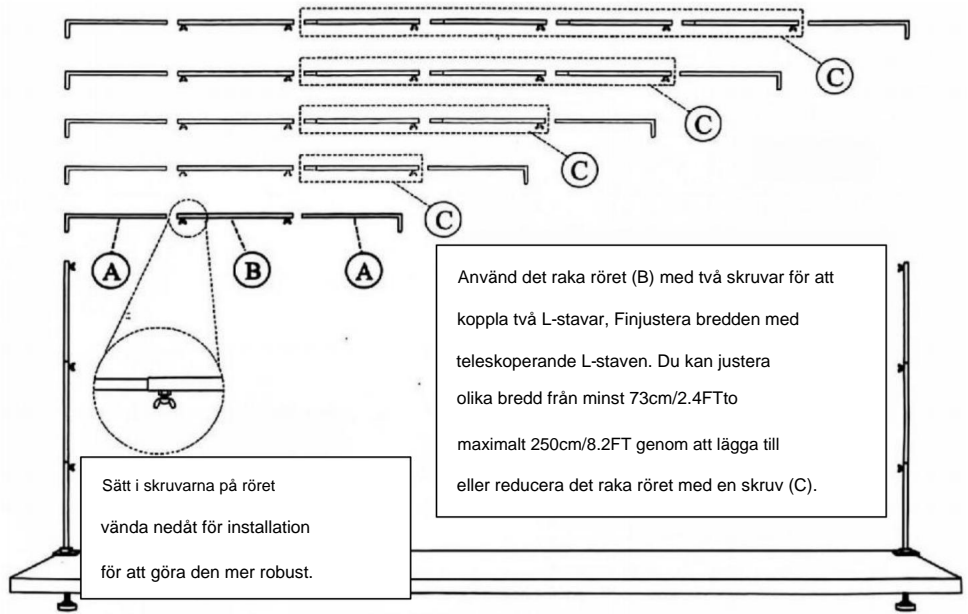

Tillverkare: Shanghaimuxinmuyeyouxiangongsi **Adress:**

Shuangchenglu 803nong11hao1602A-1609shi, baoshanqu, shanghai 200000 CN.

Importerad till AUS: SIHAO PTY LTD. 1 ROKEVA STREETEASTWOOD NSW 2122

Australien

Importerad till USA: Sanven Technology Ltd. Suite 250, 9166 Anaheim Place,

Rancho Cucamonga, CA 91730



YH CONSULTING LIMITED. C/O YH Consulting Limited

Office 147, Centurion House, London Road, Staines-

upon-Thames, Surrey, TW18 4AX



E-CrossStu GmbH

Mainzer Landstr.69,

60329 Frankfurt am Main.



Teknisk support och e-garanticertifikat
www.vevor.com/support

VEVOR

Affordable. Reliable. Home Improvement.

SOPORTE PARA CAÑA SOBRE LA MESA

MODELO: TODAS LAS TALLAS

Soporte técnico y certificado de garantía electrónica

www.vevor.com/support

VEVOR

Affordable. Reliable. Home Improvement.

VARILLA SOBRE LA MESA

PARARSE

MODELO: TODAS LAS TALLAS

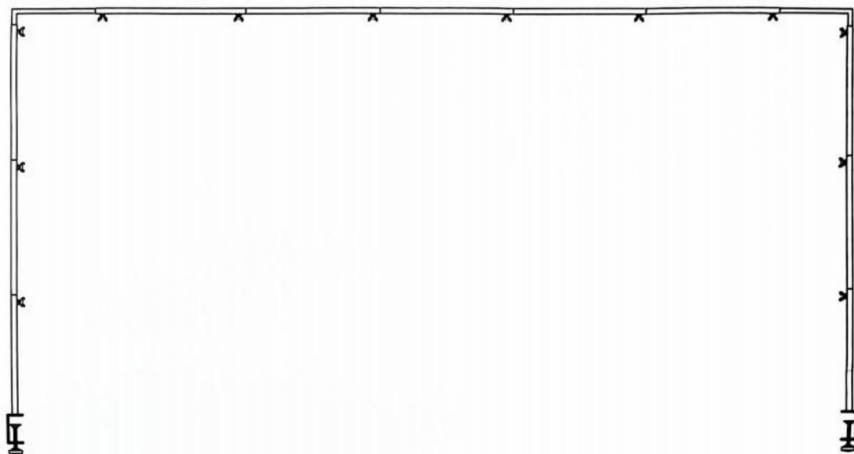

Estas son las instrucciones originales; lea atentamente todas las instrucciones del manual antes de utilizarlo. VEVOR se reserva el derecho de interpretar su manual de usuario. La apariencia del producto dependerá del producto que haya recibido. Le rogamos que nos disculpe si no le informamos de nuevo si hay actualizaciones tecnológicas o de software en nuestro producto.

Lista de piezas

Por favor, compruebe que las piezas estén completas antes de la instalación. Contáctenos si...
tienen componentes dañados o faltantes.

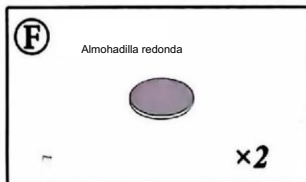
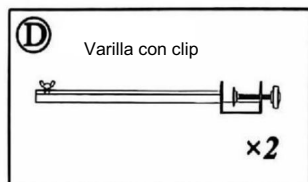
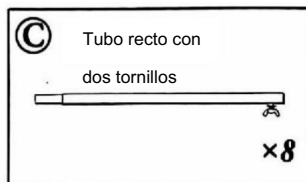
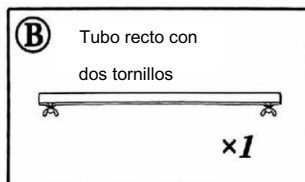
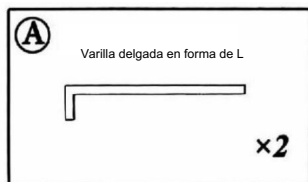

ARCO DE MESA

INSTRUCCIONES DE INSTALACIÓN

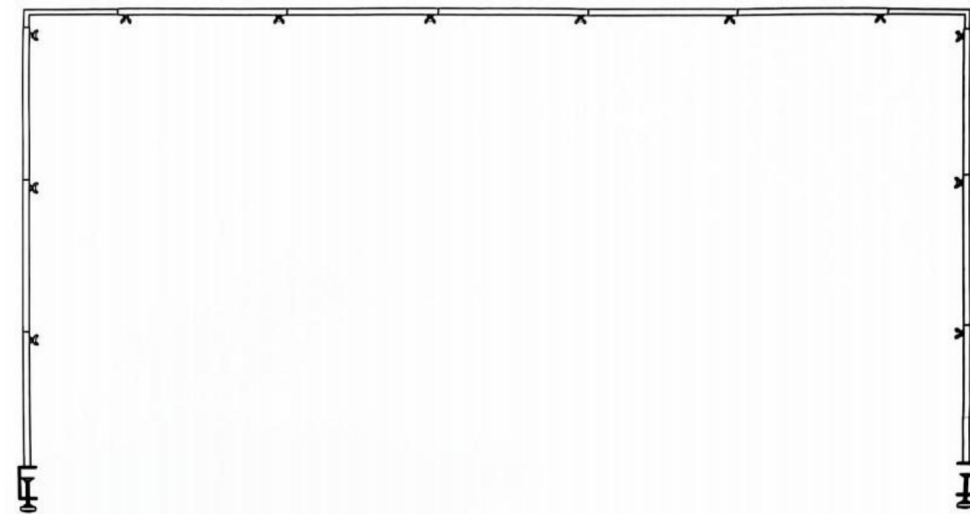

PASO 1

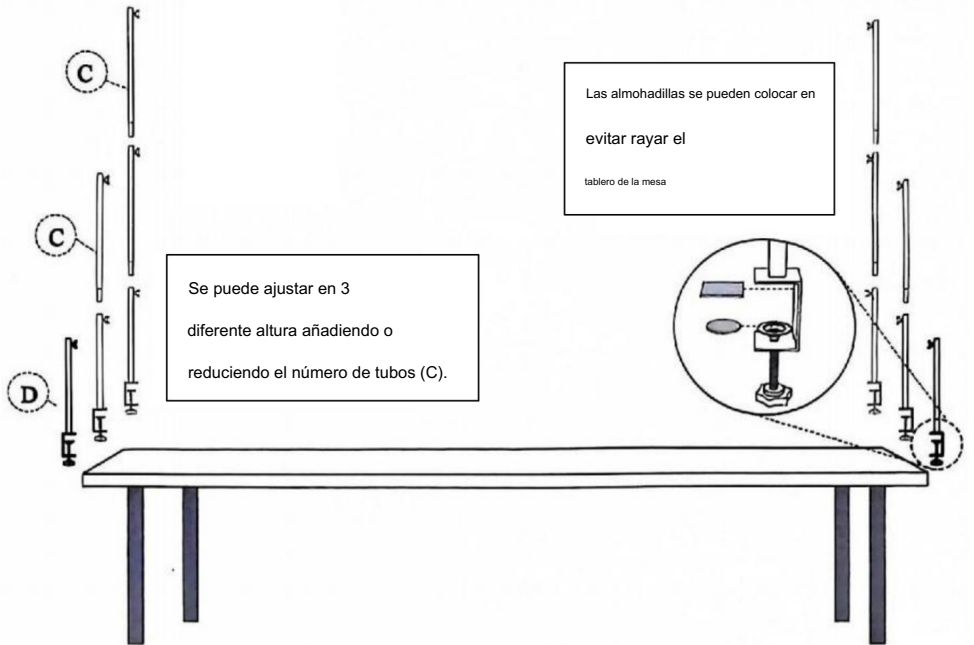

PASO 2

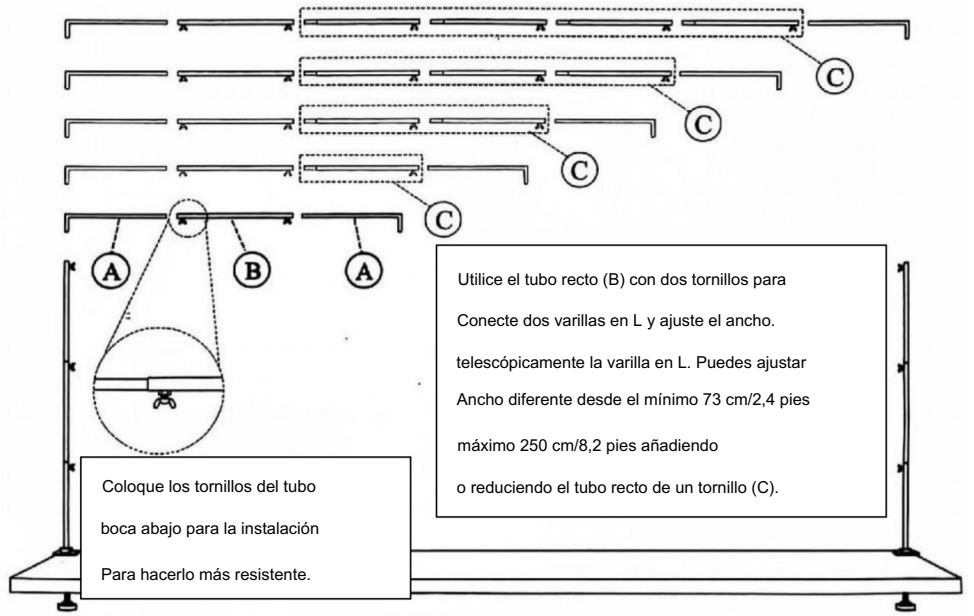

Fabricante: Shanghaimuxinmuyeyouxiangongsi Dirección:
Shuangchenglu 803nong11hao1602A-1609shi, baoshanqu, shanghai 200000 CN.

Importado a AUS: SIHAO PTY LTD. 1 ROKEVA STREET, EASTWOOD, NSW 2122,
Australia

Importado a EE. UU.: Sanven Technology Ltd. Suite 250, 9166 Anaheim Place,
Rancho Cucamonga, CA 91730

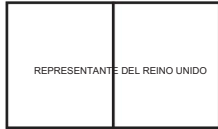

YH CONSULTING LIMITADA. A/C YH Consulting Limited
Oficina 147, Centurion House, London Road, Staines-
upon-Thames, Surrey, TW18 4AX

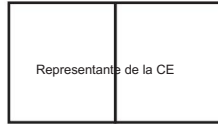

E-CrossStu GmbH
Mainzer Landstr.69,
60329 Fráncfort del Meno.



Soporte técnico y certificado de garantía
electrónica www.vevor.com/support