



SWT8043
SWT8063E
SWT9043
SWT1043
SWT9043A
SWT1023A
SWT1154DCWA
SWT1254LCWA

.....
TOP-LOAD WASHING MACHINE

.....
USER MANUAL



CONTENTS

1. SAFETY INFORMATION	2
2. PRODUCT DESCRIPTION	5
3. CONTROL PANEL	9
4. WASHING INSTRUCTIONS	17
5. DAILY USE	19
6. CARING FOR YOUR WASHING MACHINE	24
7. HELPFUL HINTS IN DEALING WITH WASHING PROBLEMS	27
8. A GUIDE TO STAIN REMOVAL	29
9. TROUBLE SHOOTING	31
10. ENVIRONMENT CONCERNS	33
11. WARRANTY	35

CUSTOMER CARE AND SERVICE

We recommend the use of original spare parts.

When contacting Service, ensure that you have the following data available.

The information can be found on the rating plate. Model, PNC, Serial Number.



Warning / Caution-Safety information.



General information and tips.



Environmental information.

Subject to change without notice.

1. SAFETY INFORMATION



CONDITIONS OF USE

- This appliance is intended to be used in household and similar applications such as:
 - Farm houses
 - By clients in serviced apartments, holiday apartments and residential type environments.
- In the interest of your safety and to ensure the correct use, before installing and first using the appliance, read this user manual carefully, including its hints and warnings.
- To avoid unnecessary mistakes and accidents, it is important to ensure that all people using the appliance are thoroughly familiar with its operation and safety features.
- Save these instructions and make sure that they remain with the appliance if it is moved or sold, so that everyone using it through its life will be properly informed on appliance use and safety.
- Use the hose supplied with the washing machine.
DO NOT USE OLD HOSES.

1.1 GENERAL SAFETY

- It is dangerous to a the specifica - tions or attempt to modify this product in anyway.

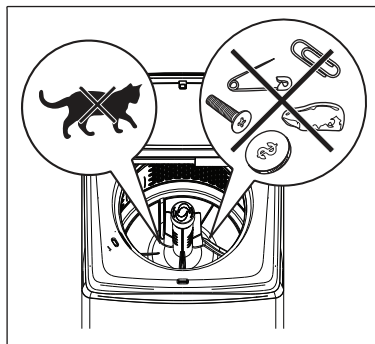

- Make sure that small pets do not climb into the washbowl. To avoid this, please check into the washbowl before using the appliance.
- Any objects such as coins, safety pins, nails, screws, stones or any other hard, sharp material can cause extensive damage and must not be placed into the machine.
- Only use the advised quantities of fabric softener and detergent. Damage to the fabric can ensue if you overfill. Refer to the manufacturer's recommendations of quantities.
- This appliance is not intended for use by persons (including children) with reduced physical, sensory or mental capabilities, or lack of experience and knowledge, unless they have been given supervision or instruction concerning use of the appliance by a person responsible for their safety.
- Wash small items such as socks, laces, washable belts etc in a washing bag or pillow case as it is possible for such items to slip down between the tub and the agitator.

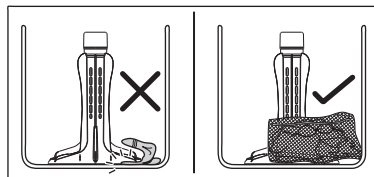

- Do not use your washing machine to wash articles with whale bones, material without hems or torn material.
- Always unplug the appliance and turn off the water supply after use, clean and maintenance.
- Under no circumstances should you attempt to repair the machine yourself. Repairs carried out by inexperienced persons may cause injury or serious malfunctioning. Contact your local Service Centre. Always insist on genuine spare parts.
- If the supply cord is damaged, should the appliance power supply cable need to be replaced, this shall be carried out by our Service Centre.

1.2 INSTALLATION

- When unpacking the appliance, check that it is not damaged. If in doubt, do not use it and contact the Service Centre.
- Appliance should not be installed in a humid place.
- After having installed the appliance, check that it is not standing on the inlet and drain hose.
- If the machine is situated on a carpeted floor, please adjust the feet in order to allow air to circulate freely.
- Always be sure, that there is no water leakage from hoses and their connections after the installation.

- Any plumbing work required to install this appliance should be carried out by a qualified plumber.
- Any electrical work required to install this appliance should be carried out by a qualified electrician.
-  Connect the machine to an earthed socket outlet.
- If this appliance is supplied from a cord extension set or electrical portable outlet device, the cord extension set or electrical portable device must be positioned so that it is not subject to splashing or ingress of moisture.
- Water pressures between minimum 50kPa and maximum 800kPa are acceptable.

1.3 USE

- This appliance is designed for domestic use. It must not be used for purposes other than those for which it was designed.
- Only wash fabrics which are designed to be machine washed. Follow the instructions on each garment label.
- Do not overload the appliance. See the relevant section in the user manual.
- Before washing, ensure that all pockets are empty and buttons and zips are fastened. Avoid washing frayed or torn articles and treat stains such as paint, ink, rust, and grass before washing.
- Garments which have been in contact with volatile petroleum products should not be machine washed. If volatile cleaning fluids are used, care should be taken to ensure that the fluid is removed from the garment before placing in the machine.

- Never pull the power supply cable to remove the plug from the socket, always take hold of the plug itself.

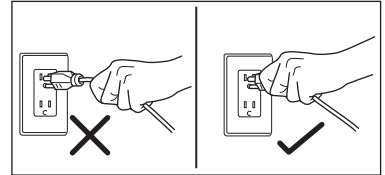

- Never use the washing machine if the power supply cable, the control panel, the working surface or the base are damaged so that the inside of the washing machine is accessible.

1.4 CHILD SAFETY

- This washing machine is not intended for use by young children or infirm persons without supervision.
- Children should be supervised to ensure that they do not play with the appliance.
- The packaging components (e.g. plastic film, polystyrene) can be dangerous to children - danger of suffocation! Keep them out of children's reach.
- Keep all detergents in a safe place out of children's reach.
- Make sure that children or pets do not climb into the washbowl.

2. PRODUCT DESCRIPTION

WASHING MACHINE PARTS **SWT8043, SWT8063E, SWT9043, SWT1043
SWT1154DCWA

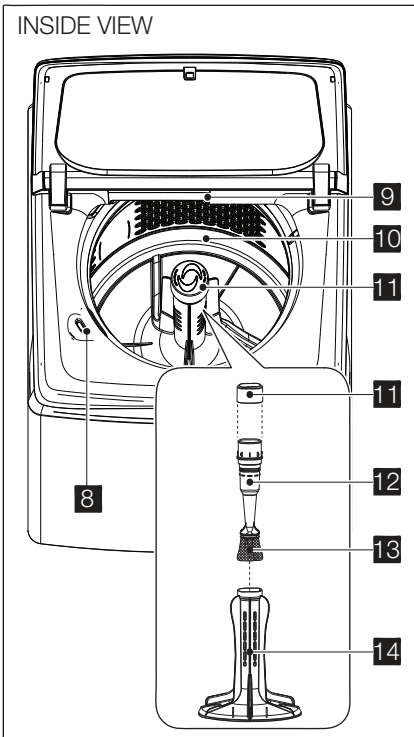
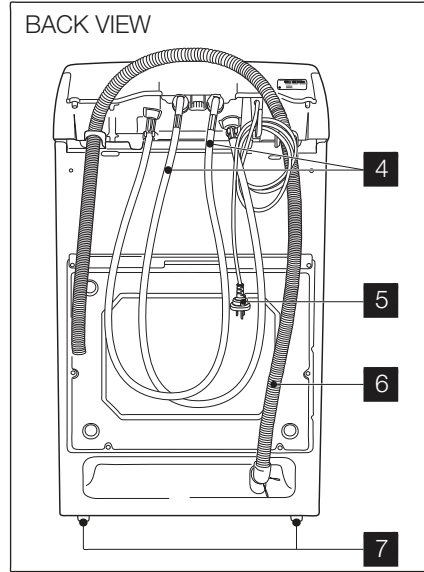
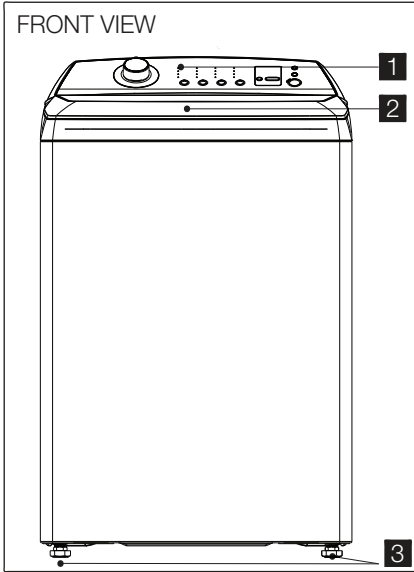

PARTS LIST

- 1 Control Panel
- 2 Machine Lid
- 3 Front Feet
- 4 Water Inlet Hose
- RED fittings (Hot Water)
- BLUE fittings (Cold Water)
- 5 Mains Cable
- 6 Outlet Hose/Drain Hose (See installation instructions to fit & position drain hose)
- 7 Back Feet
- 8 Bleach Dispenser, See Page 21
- 9 Detergent Dispenser Drawer
See Page 19
- 10 Wash Bowl
- 11 Cap Agitator
- 12 Frame Filter
- 13 Lint Filter See page 24
- 14 Agitator

2. PRODUCT DESCRIPTION

WASHING MACHINE PARTS **SWT9043A , SWT1023A, SWT1254LCWA

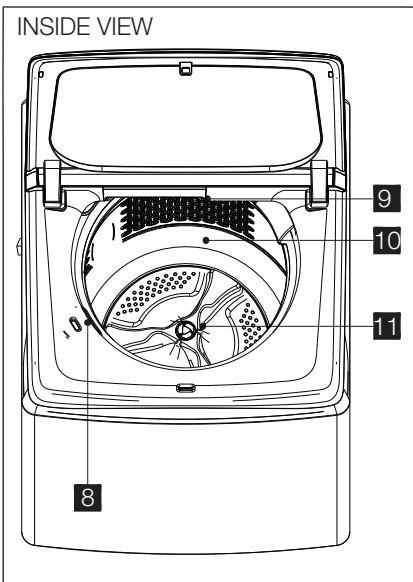
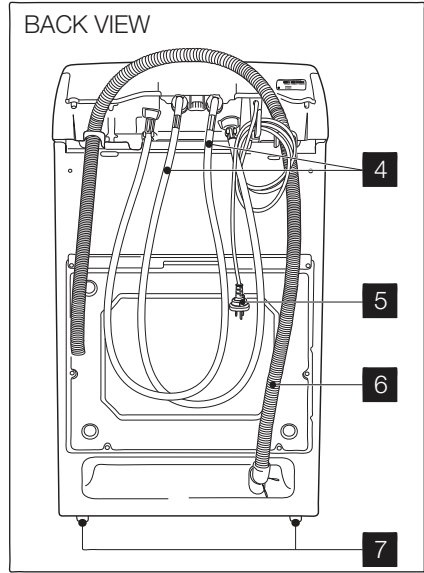
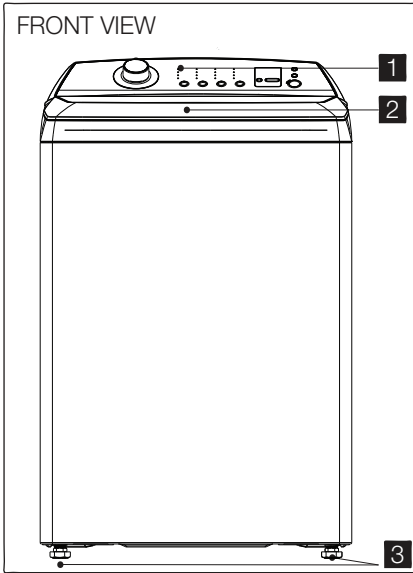

PARTS LIST

- 1** Control Panel
- 2** Machine Lid
- 3** Front Feet
- 4** Water Inlet Hose
- RED fittings (Hot Water)
- BLUE fittings (Cold Water)
- 5** Mains Cable
- 6** Outlet Hose/Drain Hose (See installation instructions to fit & position drain hose)
- 7** Back Feet
- 8** Bleach Dispenser, See Page 21
- 9** Detergent Dispenser Drawer
See Page 19
- 10** Wash Bowl
- 11** Gentle Wash Agitator
(Low Profile Agitator)

ABOUT YOUR WASHING MACHINE

• Out of Balance Interruption

The out of balance has 2 level which are low level and high level.

The high level: Machine will be stopped, caused by an uneven distribution of clothes in the wash bowl. To rectify the out of balance condition, open the lid and redistribute the clothes evenly in the wash bowl. Closing the spin stage of the wash.

The low level: The washing machine try to optimize by reduce spin speed to avoid out of balance to finish the cycle.

If you have frequent out of balance interruptions, it may be due to your washing machine not standing firm and level on the floor. This can be corrected by adjust the washing machine legs as described in the Installation Instructions supplied with your machines.

• Touchpad Response and Lights Always press touchpads gently.

Watch the lights on the control panel to see the effect pressing a touchpad or turning a program selector knob has, and listen for "BEEPS".

When you press a touchpad you will get a short "BEEP" to acknowledge the entry. If the option is not available at the time, the machine will not allow you to select it. After the machine has started, the entire wash option touchpad will be disabled and machine will give three short beeps to indicate the touchpad is disabled. The Star/Pause To Pause touchpad is still active but you need to **press and hold the touchpad for minimum 1.2 seconds to pause machine.**

This is to confirm that you really want to pause the machine.

NOTE: All functions of the washing machine will stop when the lid is open.

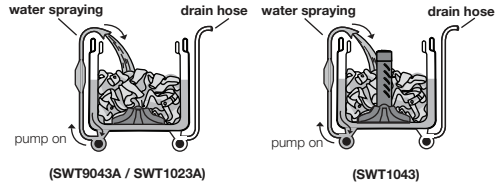

• ActiveBoost™ (Only for SWT1043/SWT9043A/SWT1023A)

This product features the new ActiveBoost Wash System that uses less amount of water, and is more energy efficient, during the washing process. It achieves this with just the right amount of water needed, and by a detergent pre-mixing system that minimizes detergent residue even during cold wash to give you a cleaner wash result.

• Wash Operation

Water at 35 °C is combined with detergent to dissolve and activate it. Depending on model, this concentrated solution is then circulated or showered over the clothes in combination with unique bowl and agitator rotations to provide wash action at the selected wash temperature.

• Agitation

After the wash operation is completed, the bowl is filled with more water. The low profile agitator or agitator then moves in an energy efficient mode, generating additional mechanical actions.

• Auto Water Level Feature

Your washing machine has selectable "Auto" sensing water level option as well as allowing you to choose a manual water level if you wish. We recommend you to use the Auto water level option to ensure there is just the right amount of water for the wash load in the machine. In other words, it will usually give you the best wash while also being the most efficient in terms of water usage.

SAVING WATER AND ENERGY

This washing machine features water and energy saving options.

To save energy, the wash time can be shortened for a load of less dirty clothes by selecting the appropriate wash program e.g. Fast Wash.

The washing machine is energy efficient and most water efficient when used with a full load of clothes and with Eco Rinse selected. You should use Eco Rinse (where available) instead of Deep Rinse to reduce the amount of water used for rinsing clothes.

Your machine is most water efficient when Eco Rinse is used as the rinse option.

Each time you switch on your washing machine the machine will select most suitable rinse option for the selected program. You can change rinse option if you wish. The difference between Deep rinse and Eco rinse is explained on the page 13.

POWER FAILURE RECOVERY

When there is power failure while machine is washing or rinsing or spinning. The machine tries to save the settings at which stage the machine is doing and then when the power returns back the machine will starts washing from the stage where it is left off.

3. CONTROL PANEL

8 Kg. SWT8043, SWT8063E

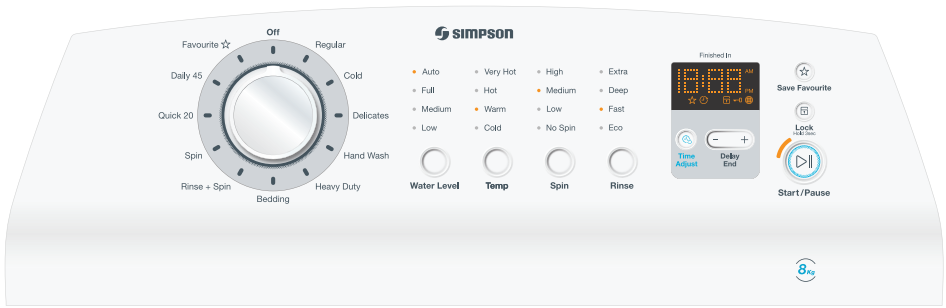

9 Kg. SWT9043 / 11 Kg. SWT1154DCWA / 12 Kg. SWT1254LCWA



10 Kg. SWT1043



9 Kg. SWT9043A

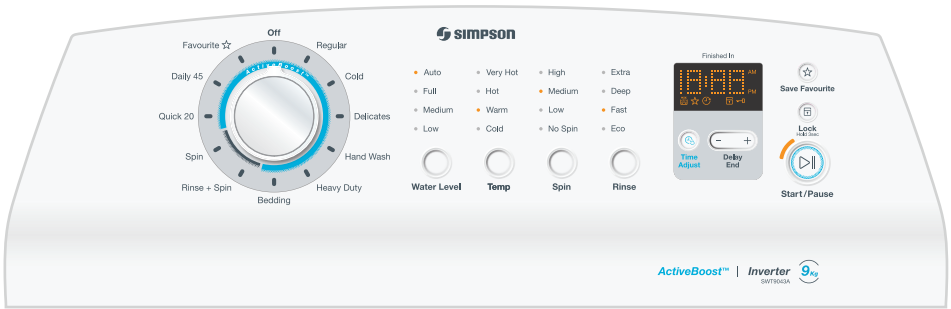

10 Kg. SWT1023A



3.1 PROGRAM SELECTOR KNOB

Turn the Program Selector knob to choose the wash program you want. The table “Your Program Guide” shown on page 16 will help you in selecting the right program.

The Program Selector knob is not a timer. Once you select a wash program, the Program Selector knob will stay at that position for the whole wash cycle.

3.2 WATER TEMPERATURES BUTTON

For each wash program your washing machine automatically selects a suitable fill water temperature. If you want to use a different wash water temperature, press the Temperature button repeatedly.

- Very Hot
- Hot
- Warm
- Cold



The water temp lights will tell you the temperature for each press of the button.

You have four temperatures to choose from Very Hot, Hot, Warm and Cold.

The temperature of warm water will depend on the temperature and pressure of your hot and cold water supplies. The recommended temperature for warm is 35°C. You can adjust the flow rate of the water supplies to adjust the Warm temperature. All rinse water temperatures are cold.

Always check your label for the washing temperature symbols which the International Care Labelling Code now uses



i NOTE:

If you have a cold water connection ONLY and the hot inlet valve is capped off (refer installation instructions) you must select Cold washes only. To fill detergent, you must follow steps as below:

1. Measure the correct amount of powder detergent by following the recommendations on the package.
2. Mix powder detergent in one litre of hot or warm water.
3. Add the pre-mixed detergent to the wash load.

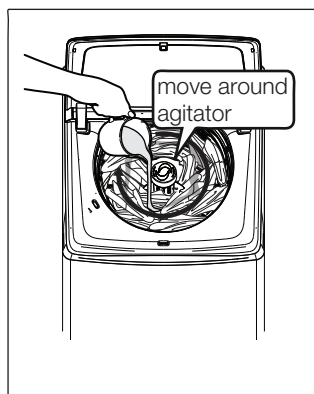

Water Temperatures

Temp.	Descriptions	Hot & Cold water usage proportion	
		Hot valve	Cold valve
Very Hot	for normally soiled white cottons and linen (e.g. teaclothes, towels, tableclothes, sheets...).	100 %	
Hot	for normally soiled, colourfast garments (e.g. shirts, night dresses, pyjamas....) in linen, cotton or synthetic fibres and for lightly soiled white cotton (e.g.underwear).	67 %	33 %
Warm	for delicate items (e.g. net curtains), mixed laundry including synthetic fibres and machine washable, non-shrink.	50 %	50 %
Cold		0 %	100 %



IMPORTANT: Components in the washing machine are designed to be used with water no hotter than 70°C. If your water supply is too hot, you should have a temperature limiting valve fitted by a qualified plumber.

Flood diagnostic is explained on page 32. You should refer to this if you have water pouring onto the floor. The display will show “E30” and you will hear rapid short beep continuously to remind you about this problem.

3.3 WATER LEVEL BUTTON

Choose the water level by pressing Water Level button. Use only the amount of water you need for the wash load.

CHOOSE THE WATER LEVEL

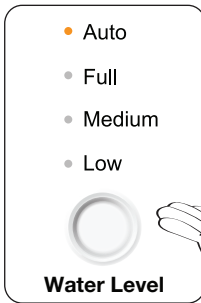

1. Choose the water level by pressing Water Level touchpad.

You can select:

- **Auto, Full, Medium and Low**

(**Auto level:** the exact water level required to wash your clothes effectively is determined and set for you automatically, ensuring no water is wasted.)

2. Use only the amount of water you need for the wash load.

3.4 CHOOSE THE SPIN

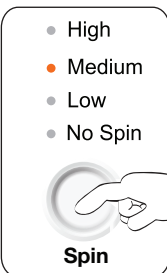

TOUCH THE OPTIONS BUTTON TO SELECT THE **SPIN** OPTION.

Regular, Cold, Bedding, Heavy Duty, Rinse+Spin, Spin, Quick 20, Daily 45, Heavy Duty, Denim(*SWT1023A), Hand Wash, Sportswear (*SWT1023A) : Can select all spin options
 Delicates : Can select Medium, Low and No Spin

Note: No spin is effect only to final spin by spin at gentle speed 1 minute only to prevent water drop to floor when moving the clothes out of the drum.

3.5 RINSE OPTION BUTTON

Pressing the “Rinse Option” touchpad allows you to change the rinse type.

For most washes the machine automatically selects “Deep Rinse” for you

There are four rinses to choose from...

Fast rinse, Eco rinse, Deep rinse and Extra rinse.

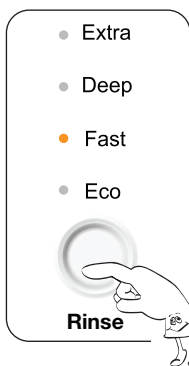

- **Extra** : Extra rinse, the machine fills twice, giving you two deep rinses.
- **Deep** : Deep rinse the machine fills once, giving you one deep rinse.
- **Eco** : Eco rinse is a spray rinse giving you maximum water saving.
- **Fast** : Fast rinse uses less time than Eco rinse by performing only 3 Eco rinses but the amount of water in each spray is increased.

How does Eco Rinse work ?

When Eco rinse is used, rinse water is sprayed into the washbowl in pulses. After each pulse the washbowl will spin to remove detergent laden water from the clothes.

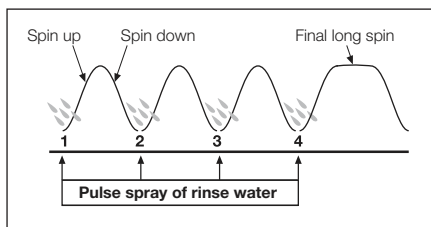

The machine will go through a series of maximum four pulses spray and short spin cycles in this manner, depending on program selection, followed by a final long spin that removes the water from the clothes to complete the full wash program.

i NOTE:

- Compare this with Deep rinse where much more water is used.
- Deep rinse, water enters the machine filling up to the wash water level selected. The washer agitates and finally empties the rinse water through the drain hose.

Extra rinse, this is special option for those people who suffer from allergies, this extra rinse will provide two deep rinses to ensure all detergent residue has been removed.

- Eco Rinse and Fast Rinse **CANNOT** be selected with Bedding program.
- **We strongly recommend** you use Eco rinse for your washes whenever you can. There is considerable saving of water when Eco is used instead of Deep or Extra to rinse clothes.
- **Eco and Fast rinse is not designed to be used with fabric softener and Fabric softener will not be dispensed when Eco or Fast Rinse is selected.**

Select **Deep** or **Extra** rinse if you are going to use fabric softener.

Deep rinse ensures the fabric softener is correctly dispensed and thoroughly removed from your clothes during rinsing.

- Daily program rinse is fixed with Deep rinse only
- Quick20 program rinse is fixed with Fast rinse only

3.6 DISPLAY

The display shows the following information:

MACHINE IN PAUSE MODE



User needs to touch [Start / Pause] button once to pause the appliance.

Under the remaining time is show text <PAUSE>

The Start/Pause button LED will blink.

WASH CYCLE IN PROGRESS

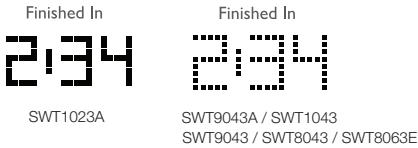

After selecting a program, the duration is displayed in hours and minutes (for example 2:34 which means 2 hour and 34 minutes)

The duration is calculated automatically on the basis of the maximum recommended load for each type of fabric.

After the program has started, the time remaining is updated every minute.

The Start/Pause button LED will always light (not blink) to indicate that now machine is in executing mode.

END OF PROGRAM

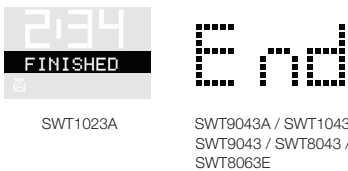

When the wash program is completed, the display shows text <FINISHED> or <END> .

The Start/Pause button LED will turn Off.

LID LOCK FEATURE

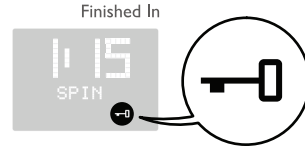

This is a safety feature so as to prevent anyone from opening the door lid when the drum is spinning.

To unlock the lid, user needs to tap [Start / Pause] button once to pause the appliance and the display will turn Off the lid lock icon.

The mechanical lock unlocks when the drum stops spinning.

The Lid Lock indicator  will light up when the feature activate (Except SWT8043, SWT8063E)

ENABLING/DISABLING END OF WASH BEEP

User can also disable the buzzer by pressing the [Water Level] button + [Spin] button down for 3 sec and release.

it will disable power on sound also.

The volume level is set in the factory and cannot be adjusted by the user.

3.7 START/PAUSE BUTTON

TO START THE WASH CYCLE / PROGRAM

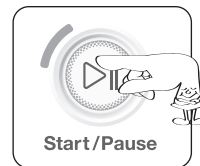

Press the Start/Pause button to Pause.

Start/Pause to Pause is used to Start, Stop and Continue the wash.

If you have started your wash and you wish to stop it for some reason, press the Start/Pause To Pause touchpad and hold it for **1.2 seconds** to enter pause mode.



3.8 FAVOURITE , CHILD LOCK , TIME ADJUST , DELAY END BUTTON

FAVOURITE

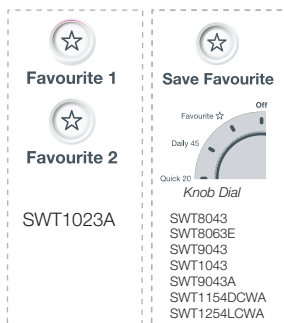

FIG A.

FIG B.

The favourite function is the ability to tailor individual wash features and save them as a custom programme until the next time.

FIG A : Select the Favourite 1 or 2, choose wash method, spin , temperature ,Rinse, then touch and hold the Favourite button for >1.5 seconds .“Beep sound”is activated and the programme is stored for later use with a single button press.

FIG B : Select the Save Favourite, choose wash method, spin , temperature ,Rinse, then touch and hold the Favourite button for >1.5 seconds .“Beep sound”is activated and the programme is stored for later use with select Favourite program on Knob Dial.

The Favourite indicator  will light up when this feature is activated.

CHILD LOCK

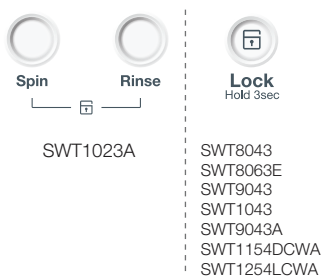

FIG A.

FIG B.

Your appliance is provided with CHILD SAFETY LOCK which permits you to leave the appliance unsupervised with the door closed without having to worry that children might be injured by or cause damage to the appliance.

To Activate the child lock :

FIG A : Hold down the “Spin” and “Rinse” at the same time for 3 seconds.

FIG B : Hold down the “Lock” for 3 seconds.

The child lock indicator  will light up when this feature is activated.

To Deactivate the child lock :

FIG A : Hold down the “Spin” and “Rinse” at the same time for 3 seconds.

FIG B : Hold down the “Lock” for 3 seconds,

The child lock indicator  will disappear when this feature is deactivated.

When child lock is activated, the door will be locked all the time during the machine is working.

TIME ADJUST

This option allows you to increase/decrease washing time by changing the 3 different levels.

: medium > maximum > minimum



**Time
Adjust**

DELAY END



**Delay
End**

You can set your washing machine to finish your wash at a later time you specify, choosing a delay of between 1 to 19 hours in 1-hour increments. The hour displayed indicates the time when the cycle will finish. After selecting the wash program, tapping on either the [-] or [+] button once will start the delay end and set the 1-19 hours of the end time of the entire wash cycle.

Tapping [+] button increases the end time.

Tapping [-] button decreases the end time.

Press the **Start / Pause button**

The Delay end indicator  will light up and the clock will begin counting down until it reaches the set time.



NOTE: When indication  appears and blinks after appropriate number of wash cycles are finished, this is to remind user to clean the lint filters. See page 24.

To clear this indication turn the knob to Off position for SWT8043, SWT8063E, SWT9043, SWT1043.



3.9 YOUR PROGRAM GUIDE (KNOB DIAL)

Program	Model		Select this program	Recommended				
	SWT1023A	SWT9043A SWT1043 SWT9043 SWT8043 SWT1154DCWA SWT1254LCWA		Water	Temp	Spin	Soak	Rinse
Regular *	<input type="radio"/>	<input type="radio"/>	For normally soiled cotton load at rated load capacity.	Auto	Warm	High	No Soak	Deep/Eco*
Cold	<input type="radio"/>	<input type="radio"/>	For synthetic or mixed fabrics, underwear, coloured garments, non-shrink shirts, blouses.	Auto	Cold	High	No Soak	Deep
Delicates	<input type="radio"/>	<input type="radio"/>	For lingerie, lace, trimmed and embroidered items.	Auto	Cold	Medium	No Soak	Deep
Bedding	<input type="radio"/>	<input type="radio"/>	For bedding fabrics labelled "Machine Washable"	Auto	Hot	High	No Soak	Deep
Heavy Duty *	<input type="radio"/>	<input type="radio"/>	For a heavily soiled cotton wash load.	Auto	Warm	High	No Soak	Deep
Soak & Wash	<input type="radio"/>	<input checked="" type="radio"/>	For normally soiled cotton load.	Auto	Warm	High	No Soak	Deep
Tub Cleaning	<input type="radio"/>	<input checked="" type="radio"/>	Clean the tub.	-	Hot	-	No Soak	-
Rinse+Spin	<input type="radio"/>	<input type="radio"/>	For items that you want to rinse and spin eg. clothes items you have hand washed in a wash tub.	Full	Cold	High	No Soak	Deep
Spin	<input type="radio"/>	<input type="radio"/>	For very wet clothes to remove the water.	-	-	High	No Soak	-
Denim	<input type="radio"/>	<input checked="" type="radio"/>	For a heavily soiled Denim/Jeans wash load.	Auto	Warm	High	No Soak	Deep
Sports Wear	<input type="radio"/>	<input checked="" type="radio"/>	For a Sport ware fabrics labelled "Machine Washable"	Auto	Warm	High	No Soak	Deep
Hand Wash	<input type="radio"/>	<input type="radio"/>	For wool fabric and Hand Wash labelled "Machine Washable"	Auto	Warm	Medium	No Soak	Deep
Quick 20	<input type="radio"/>	<input type="radio"/>	For a very small load of mixed fabrics.	Low	Warm	High	No Soak	Fast
Daily 45	<input type="radio"/>	<input type="radio"/>	For a small load of mixed fabrics.	Auto	Warm	High	No Soak	Deep
Favourite ☆	<input checked="" type="radio"/>	<input type="radio"/>	For using favourite program.	-	-	-	No Soak	-

* "Regular wash, Auto level, Warm, High spin, Eco rinse, Max Time Adjust" is recommended for a full load of normally soiled cottons.

* Heavy Duty has a built-in Soak period of 6 minutes.

4. WASHING INSTRUCTIONS

These Washing Instructions are of a general nature and you should get good wash results by following them.

However, due to the variables of fabric types, soil levels, detergent types and available program settings you may find some combinations of these which do not always result in the perfect wash.

If for example you see residuals of detergent or soils on some items, please read the section Residues on washed items paragraph.

Over time you will learn what is the best set-up of programs, detergent and load sorting for different load types and soils.

4.1 SORT YOUR WASHING INTO SEPARATE WASH LOADS



- Each load of washing should contain clothing which needs the same washing conditions. For example, you should not wash delicate clothes with very dirty work clothes.
- Colour fast and non-colourfast fabrics should be separated. Knowing the type of fabrics you have and how dirty they are will help when you make selections from the wash program options.
- Some fabrics are lint collectors and can pick up lint, dirt and colour from other fabrics which are lint producers. Some examples are listed below:

Lint collectors	Lint producers
- Corduroy - Synthetics - Permanent press fabrics	- Towels - Nappies - Chenille/ Candlewick

i NOTE:

Make sure that you wash lint collectors separately from lint producers.

- Never wash whites and coloureds together. Whites may lose their “whiteness” in the wash.
- New coloured items may run in the first wash; they should therefore be washed separately the first time.

! IMPORTANT!

Make sure that no metal objects are left in the laundry (e.g. hair clips, safety pins, pins).

- Button up pillowcases, close zip fasteners, hooks and poppers.

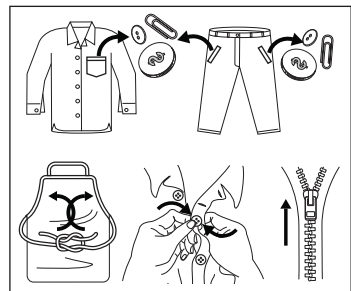

- Tie any belts or long tapes.
- Remove persistent stains before washing.
- Rub particularly soiled areas with a special detergent or detergent paste.
- Treat curtains with special care.

- Wash bras, pantyhose and other delicates in a mesh laundry bag, which you can purchase from your supermarket.

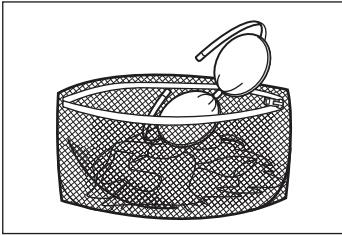

- Remove hooks or tie them up in a bag or net.

4.2 PRE-TREATMENT SPRAYS AND STAIN REMOVERS



WARNING!

Pre-treatment sprays and stain remover can damage plastic components on your washing machine.

If you use pre-treatment sprays or stain removers, apply them to the clothing well away from your washing machine.

4.3 DETERGENT

Good washing results also depend on the choice of detergent and use of the correct quantities to avoid waste and protect the environment.

Although biodegradable, detergents contain substances which, in large quantities, can upset the delicate balance of nature.

The choice of detergent will depend on the type of fabric (delicates, cottons, etc.), the colour, washing temperature and degree of soiling.

- Don't use the wrong type of detergent. You must use a low sudsing detergent designed for front load washing machines or high efficiency top loaders, such as Cold Power for Front Loaders and High Efficiency Top Loaders or detergents labelled "Matic".
- Don't use soap-based products in your washing machine.
- Don't use too much detergent. This can result in excessive suds that can cause low spin speeds, poor rinsing and overloading the motor during spin stages of the wash program.
- Don't use too little detergent because you will get a poor wash. If you think you need more, increase dosages by only small amounts to avoid excessive suds.

Quantity of detergent to be used

The type and quantity of detergent will depend on the type of fabric, load size, degree of soiling and hardness of the water used.

Water hardness is classified in so-called "degrees" of hardness.

Information on hardness of the water in your area can be obtained from the relevant water supply company, or from your local authority.

Follow the product manufacturers' instructions on quantities to use.

- Not enough washing powder causes: the washload to turn grey, greasy clothes.
- Too much washing powder causes: sudsing, reduced washing effect, inadequate rinsing.
- Use less detergent if: you are washing a small load, the laundry is lightly soiled, large amounts of foam form during washing.

5. DAILY USE

5.1 STARTING YOUR WASHING MACHINE

1. Connect the mains plug to the mains socket.
2. Turn the water tap on.

5.2 LOAD THE WASHING MACHINE

When loading the clothes into your washing machine, there are four things to remember:

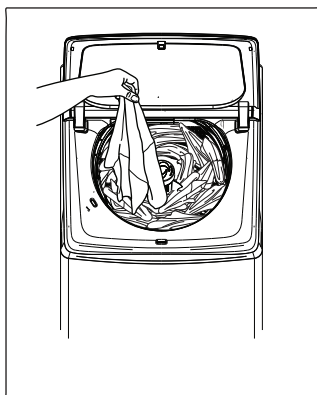

1. Clothes must be loaded evenly around the agitator.
For best result load small items first, followed by large items.
For example, a typical load should be loaded using the following sequence : handkerchiefs, wash cloths, undershorts, pillow cases, T-shirts, business shirts, tablecloths, sheets, bath towels.
2. Clothes must not be wrapped around the agitator.
3. The washing machine must not be overloaded.
Clothes must be able to move during wash.
4. The load should contain only three or four large items, for example sheets. The rest of the load should be small items. A mixed load of large and small items will wash cleaner than a load of all large items.

5.3 ADD THE DETERGENT

When using the washing machine for the first time, check that the dispenser is set for the type of detergent you will use. To do this, proceed as follows:

1. Pull the dispenser drawer forward until it stops.
2. Lift the front of the drawer up and forward to

remove it from the runners.

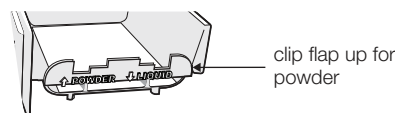

3. Check the position of the flap at the rear of the detergent compartment in the dispenser drawer.
(Factory setting is flap up for powder.)
4. Clip the flap down if you intend to use liquid detergent.

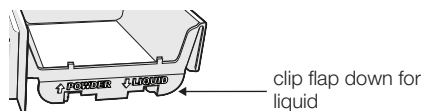

5. Refit the dispenser back into its runners.

Remember: If you change the type of detergent you use, the position of the flap will need changing. See picture.

6. You are now ready to add detergent.
Measure the amount required and pour it into the detergent compartment of the dispenser drawer.

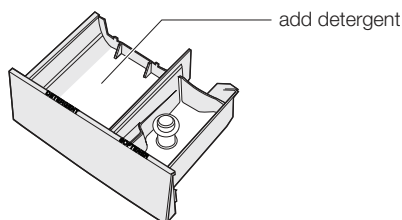

When using liquid detergent, some may leak out of the dispenser into the wash load earlier than expected through small openings in the back of the dispenser.

The openings are to help flushing out of detergent.

7. If you want to use fabric softener, see “Add fabric softener”.

8. Close the drawer by pushing it backwards into the top panel of the washing machine when you have finished adding detergent.



Don't do these things:

- Using too little detergent will give you a poor wash result.
- Using excessive detergent will create too much suds and may cause overloading of the motor during the spin stage of the wash cycle.

To avoid excessive suds, reduce the amount of detergent you use. It is best to use detergent labelled low susing. Good quality, front load detergent will perform well in this machine.

- Use soap based products in your washing machine.

5.4 ADD FABRIC SOFTENER

Before adding softener to the dispenser, make sure the siphon cap is pushed firmly down onto the spigot in the drawer.

The softener will not siphon out if the cap is incorrectly fitted, is missing or blocked with residue. You are now ready to add fabric softener.

Measure the correct amount as recommended on the softener package into a cup and then pour it into the softener compartment of the dispenser drawer.

Caution: Do not overfill the fabric softener dispenser.

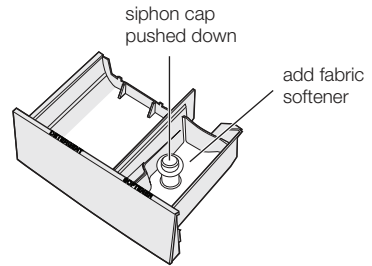

Overfilling and then siphoning out too early can cause softener and detergent to mix resulting in staining problems.

The softener dispenser holds 90ml when filled up to the MAX marker. Any level lower than MAX will function correctly.

Caution: Only use the detergent compartment for detergent and the fabric softener compartment for fabric softener.

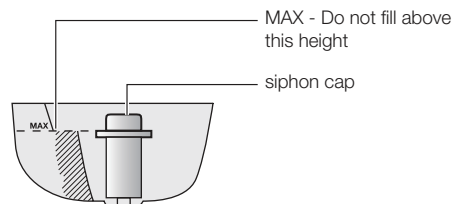

5.5 ADDING BLEACH



Bleaching of clothes can help to remove stains, heavy soiling and to kill bacteria.

Oxygen type - This is generally a powder type bleach. Mix the required quantity with water and pour down the hole in the top panel during the fill when there is some water in the wash bowl.

Refer to the instructions on the bleach container.

Chlorine type - This type of bleach should **NOT** be mixed with detergent. Mix the bleach with water as per the instructions on the container.

- Turn Program Selector to a Regular Wash position.
- Press the Start/Pasue To Pause touchpad to commence water fill.
- Pour the bleach solution down the hole in the top panel during fill when there is some water in the wash bowl.
- Allow the machine to agitate for a few minutes, then let it stand for the required time by pressing and holding the Start/Pause touchpad for 1.2 seconds to pause machine.
- Turn Program Select to Drain & Spin position and press the Start/Pause touchpad to empty the wash bowl.
- You can now wash the clothes load using detergent and your selected wash program.

i NOTE : Bleach should NOT be used on silk, wool, rayon or drip dry clothes.

Lid Soft Landing Feature (Except SWT8063E)

When the lid is fully opened, to close just pull down initially the lid then the lid will close down slowly by itself.



Lid soft landing device will not be working if opened less than 80 degree **(Please keep your hand away, lid will close rapidly and hurt your hand).**

5.6 SETTING A PROGRAM



1. Turn the program selector to the required program.
 - Your washing machine is now in STAND-BY-MODE and ready to wash your clothes.
 - Press the ON/OFF button (SWT1023A)
 - The relevant light will light up.
 - The buzzer will sound.
 - The selector dial can be turned either clockwise or anticlockwise.
 - Once you selected a program, the program selected will stay at that position for the whole of the cycle.
 - The display shows the program duration.

If the settings shown on the control panel are what you want to use, press the Start/Pause button to start your wash.

2. If you want your laundry to be washed with functions different from the one proposed by the machine, press Temperature, Water Level, Spin Time and Rinse Option buttons.

i NOTE:

Different functions can be combined which is dependent on the program selected.

When these buttons are pressed, the corresponding pilot lights come on.

3. If you want to define the end of the washing program, press the “Delay End” button repeatedly to choose your machine end time.

5.7 STARTING A PROGRAM

To start a program, press the Start/Pause button, a default program duration will be displayed on the screen.

i NOTE

- When you select the Drain+Spin program, there will be a delay of at least 2 minutes before the washing machine starts to spin. This delay is a pump out (Drain) period to ensure the bowl is empty of water, which is necessary before spin commences. Even though you may have only put wet clothes into an empty bowl, the delay before spin will still occur to be safe and to protect your washing machine.

5.8 INTERRUPTION OF A PROGRAM

If you have started your wash and you wish to stop it for some reason, press the Start/Pause button to enter PAUSE mode. The time remaining is shown then “ PAUSE ”.

Press the Start/Pause again. The program will continue.

5.9 CHANGING A PROGRAM

You can turn the Program Selector Knob to a new program position at any time. If you do move the Program Selector Knob the effect will be different depending on the status of the machine at the time you do this, as follows:

- When the machine is in PAUSE mode, moving the Knob to a new position 3 short beeps to remind you that cannot change the program in pause mode.
- When the machine is running, moving the Knob to a new position will result in the machine continuing the wash and 3 beeps to remind you that this option is not allowed.

5.10 CHANGING THE OPTIONS

It is possible to change only before start the program.

5.11 AT THE END OF THE PROGRAM

- The appliance stops automatically.
- The display will show
 - SWT1023A : “ FINISHED ”
 - SWT1043 / SWT9043 / SWT8043 / SWT8063E / SWT9043A
SWT1154DCWA / SWT1254LCWA : “ END ”

and with End sound every 15 second in 2 minutes.

- Turn the Program Selector knob to the position “ Off ” or Press the ON/OFF button (SWT1023A)
- Remove the laundry from the appliance. Make sure that the washing tub is empty.
- Keep the lid ajar, to prevent the mildew and odours.
- Turn off the water tap.

5.12 AUTO OFF

After 5 min without any user interaction with the appliance, during the machine is in stand by or after the end of the cycle, the appliance receives no further instructions, it will automatically turned Off

(for energy savings in conformity with the standards on energy consumption).

All the settings are stored so that when the appliance is turned back on, the program is ready or if the auto-off mode was triggered after the end of the cycle, the user can see that the cycle ended normally, and can restart it.

6. CARING FOR YOUR WASHING MACHINE

Your washing machine will give you long and trouble-free service, if you follow the instructions in this section. These instructions show you how to care for your washing machine.

6.1 WHAT TO DO AFTER YOU HAVE FINISHED YOUR WASHING.

1. Turn the Program Selector knob to the position "Off".
2. Switch off the electricity at the power point.
3. Turn off the water taps. This will extend the life of the inlet hoses.
4. Leave lid open for a while. This allows time for moisture inside the washing machine to evaporate and for any odours to disperse.

6.2 CLEANING THE LINT FILTER

Lint is a collection of threads and fluff which comes off your clothes during washing. Your washing machine collects this lint in the lint filter. It is important to clean out this lint filter preferably after each wash.

How to clean the lint filter:

(SWT8043, SWT8063E, SWT9043, SWT1043, SWT1154LCWA)

1. Remove the Cap Agitator and filter column from the centre of the agitator.

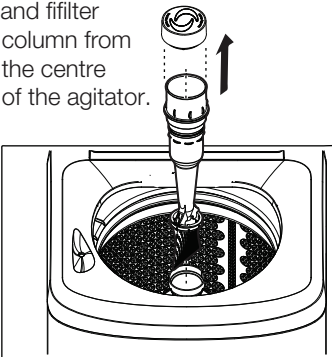

2. Unclip the filter bag from the column.

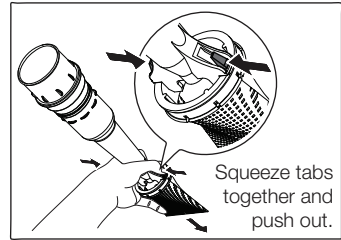

3. Turn the bag inside out and remove the lint.

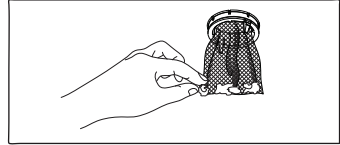

4. Wash the filter bag and dispenser cup in hot water.
5. Reassemble the filter to the column and place it back in the centre of the agitator.

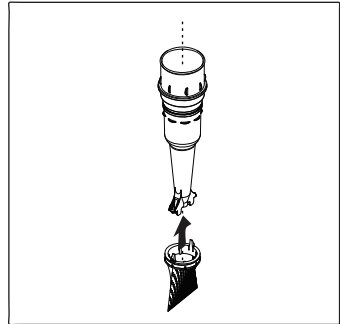

6.3 CLEANING THE DISPENSER

The dispenser needs to be cleaned regularly, preferably after each wash. Inspect the dispenser after each wash to see if there is any residue of detergent.

To do this proceed as follows:

- Pull the dispenser drawer forward until it stops.
- Lift the front of the drawer up and forward to remove it from the runners.
- Clean the dispenser drawer with hot water and a brush, eg. an old toothbrush.
- Dry the drawer.
- Before replacing the dispenser back in its recess, clean the inside of the drawer with an old toothbrush.
- Put the dispenser back into its runners and close the drawer.

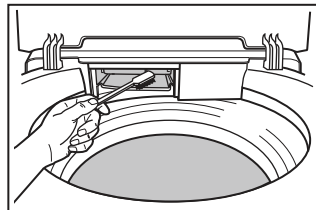

6.4 CLEANING YOUR WASHING MACHINE

To clean the inside and outside of your washing machine you should:

1. Wipe the surface with a mild dishwashing detergent and warm water.
2. Wipe dry with a soft cloth.

i **IMPORTANT:** Never use solvents, aerosol cleaners, spray pack cleaners, glass, cleaners, metal polishes, caustic materials, scourers or general household cleaners on or near top panel and lid, control panel or other parts of your washing machine.

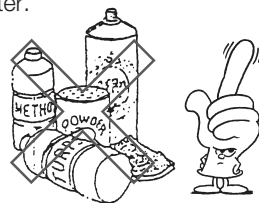

6.5 CLEANING STAINS IN THE WASHBOWL

Stains in the wash bowl can be caused by:

- metal objects such as bobby pins, dressmaking pins and nails;
- salt;
- body oils and grease from very dirty or sweaty clothes being deposited around the top of the washbowl;
- excessive foam during wash if incorrect or too much detergent is used.

i IMPORTANT:

Check all pockets before loading clothes into your washing machine.

Don't leave wet clothing (especially swimwear) in the bowl for too long before you wash it.

How To Clean the Stainless Steel Wash Bowl :

1. Wipe with a cleaning product which is marked suitable for stainless steel.
2. Oily deposits can be removed by wiping surfaces with a mild dishwashing detergent and warm water.

i IMPORTANT:

Never use bleach cleaners or steel wool to clean the stainless steel washbowl.

6.6 AVOIDING BUILD UP OF UNDISSOLVED DETERGENTS

If you only wash with cold water, undissolved detergent and body oils will build up in the washing machine. This build-up can cause spotting on your clothes.

To avoid this build-up :

- do not use too much fabric softener with cold water;
- select a hot water wash at least once a month;
- always dissolve the detergent in one litre of warm water.

7. HELPFUL HINTS IN DEALING WITH WASHING PROBLEMS

7.1 RESIDUES ON WASHED ITEMS

Some detergents have ingredients which do not fully dissolve and as a consequence, may leave white residue or particles evident on the surface of darker clothes in the finished wash load. Similarly some soils may not dissolve fully, resulting in residue evident on lighter coloured clothes.

If you are experiencing residue on some clothes, the following tips will help:

- Check that you are using frontload type detergent to minimise over-sudsing. You may find different brands of detergent give better results. Liquid detergent may be better than powder in your situation.
- Pre-mix the detergent thoroughly in warm or hot water to improve the dissolving.
- Reduce detergent dosage to between a 1/2 and 2/3 of the manufacturer's standard recommendation to avoid over concentration (the lower water usage requires lower detergent usage.)
- Some residue maybe re-deposited lint, so be careful not to have lint-producing items in a load which has darker clothes.
- Select deep rinse and not eco rinse to help flush more particles away.
- Reduce the clothes load size per wash to give more freedom for the clothes to move around in the wash bowl.

- Use another program as below, which has been designed to minimise residual particles (they are in order of increasing benefit and will help you choose the best program for your wash load.)
 - The Colours Program
 - The Heavy Duty Program

7.2 STAINED CLOTHES - HINTS FOR REMOVING STAINS

The guide to stain removal on page 30 may assist you in stain removal.

Treat all stains as soon as possible. The longer you leave a stain the harder it will be to remove. Try soakers and stain removers first.

If you use pre-treatment sprays or stain removers, apply them to the clothes items in a well ventilated area away from your washing machine.

- Avoid the use of hot water on stains as hot water will set stains.
- Use light strokes and don't rub the stain remover into the fabric.
- If you use a chlorine bleach, follow the instructions on the bottle and dilute it before putting it on clothing.
- Test coloured fabrics on an inside seam for colour fastness before using any stain removers or bleaches.
- Test synthetic fabric on an inside seam before using any chemicals or bleaches.

NOTE:

Chemicals referred to for stain removal are available from your local supermarket, hardware store or the chemist.

**WARNING !**

Pre-treatment sprays and stain removers can damage plastic components on your washing machine.

**CAUTION !**

Do not use dry cleaning fluids or solvents near your washing machine. These fluids will damage your washing machine and may cause an explosion.

7.3 YELLOWING OR GREYING CLOTHES

Problem	Possible causes	What to do
Greyness	<ul style="list-style-type: none"> • Incorrect wash times and using insufficient detergent which can cause redepositing of detergent on clothes. • Using incorrect type or too much detergent can cause poor rinsing and poor spin performance. • Mixing whites with very dirty clothes, eg work clothes. • Using soap flakes instead of laundry detergent. 	<ol style="list-style-type: none"> 1. ONLY use low sudsing, front load washer detergent in this machine, such as Cold Power for Front Loaders and High Efficiency Top Loaders or detergent labelled "Matic". 2. Re-sort load, then re-wash using program selections suitable for the fabric using hot or warm water. 3. If the water is very dirty or very sudsy, repeat 2 above reducing the amount of detergent you use.
Yellowing	<ul style="list-style-type: none"> • A build-up of oils in clothes that come into close contact with the skin, eg underwear, T-shirts. • Ageing of clothes. Iron deposits in the wash water. • Use of chlorine bleaches on fabrics with resin finishes. • Incorrect drying. • Incorrect water temperatures ie. too hot or too cold. 	<ol style="list-style-type: none"> 1. Re-sort load, then re-wash using wash program selections suitable for the fabric using hot or warm water. 2. If the water is very dirty or very sudsy, repeat 1 above reducing the amount of detergent you use. <p><i>NOTE: Synthetics which have been washed in very hot water will not respond to any treatment.</i></p>

8. A GUIDE TO STAIN REMOVAL

Stain	White Cottons And Linens	Washable Coloured Fabrics
Ball Point Pen Ink	Sponge with methylated spirit. Bleach if required.	Same as for whites - use oxygen type bleach.
Beetroot	Rinse as soon as possible under cold water. Bleach if necessary.	Same as for whites - use oxygen type bleach.
Blood, Meat Juice, Egg (Dry Stain)	Cover area with meat tenderiser (msg). Apply warm water to make a paste. Wait 15-20 minutes. Sponge with cool water or with diluted bleach.	Same as for whites but select water temperature suitable to fabric - use oxygen type bleach.
Blood, Meat Juice, Egg (Fresh Stain)	Rinse in cold water. If stain remains, sprinkle with meat tenderiser (msg). Let stand for 15-20 minutes. If stain still remains, then sponge with diluted bleach. Wash using hot water.	Same as for whites but select water temperature suitable to fabric - use oxygen type bleach.
Candle Wax	Scrape off excess, place stain between clean white blotter or several layers of facial tissue. Sponge with dry cleaning fluid. If spot remains, bleach.	Same as for whites - use oxygen type bleach.
Chewing Gum	Rub with ice to harden. Scrape off excess with blunt knife. Sponge with dry cleaning fluid.	Same as for whites.
Chocolate	Soak in warm water with pre-soak product, and wash in lukewarm water. Use dry cleaning fluid (white spirits) to remove any grease spots.	Soak in warm water with pre-soak or detergent solution. Treat any remaining stain with oxygen bleach.
Coffee/tea (Milk Or Cream)	Rinse or soak in cold water. Work detergent into stain. Thoroughly rinse and dry. If a stain remains, sponge with dry cleaning fluid. If stain remains, bleach.	Same as for whites - use oxygen type bleach.
Coffee/tea (Black), Fruit Juice, White Wine	Pour boiling water through stain. Bleach if necessary.	Soak or rinse in cold water or sponge with warm water and detergent. Use oxygen type bleach.
Correcting Fluid	Scrape off as much as possible. Rub clean with paint thinner or white spirits.	Same as for whites.
Cosmetics	Sponge with prewash stain remover, liquid detergent or rub with soap. If greasy stain persists, soak in enzyme product then wash.	Same as for whites.

Stain	White Cottons And Linens	Washable Coloured Fabrics
Curries	Soak/rinse in lukewarm water until a majority of the colour is removed. Sponge with solvent to break down any remaining fats and oils then wash.	Same as for whites. Check for colour fastness before applying solvent.
Fat/Grease/Oil	Sponge with dry cleaning fluid (white spirits).	Same as for whites.
Fruit	Sponge with warm water and wash. Bleach remaining stain with oxygen bleach.	Pour boiling water through stain. Bleach remaining stain.
Grass, Green Vegetables	Sponge with methylated spirit. Wash using warm water.	Same as for whites. Check colourfastness before applying methylated spirit. For acetate, sponge with dry cleaning fluid.
Ice Cream, Cream Milk	Rinse or soak in cold water then wash. If ice cream contains fruit or chocolate treat as such.	Same as for whites.
Iodine	Wash using hot water.	Wash using warm water.
Iron Rust	Apply oxalic acid and place in sun.	Apply lemon juice and place in sun.
Lipstick	Rub with lard and wash using hot water. Bleach if necessary.	Rub with lard and wash using warm water.
Mildew	Wash using hot water. Moisten with lemon juice and let dry in sun. If stain persists, bleach. Old stains are hard to remove.	Same as for whites but select water temperature to suit fabric.
Mustard	Wash using hot water and bleach.	Wash using warm water and use oxygen bleach.
Nail Polish	Sponge with dry cleaning fluid or nail polish remover. Bleach remove dye.	Sponge with dry cleaning fluid.
Paint (Oil Based)	Scrape off fresh paint. Soften dry paint with lard or oil, then sponge with turpentine (turps).	Same as for whites.
Red Wine	Rub salt into the stain. Pour boiling water through stain. Bleach if necessary.	Same as for whites.
Scorch	Moisten and place in sunlight. Bleach if necessary.	Usually a permanent stain. Brush wools lightly with sandpaper.
Tomato Sauce	Soak in cool water for 10 minutes. Rub in liquid detergent then wash. If stain persists, try dry cleaning fluid or bleach.	Same as for whites - use oxygen type bleach.

9. TROUBLE SHOOTING

DO NOT call for service until you have checked the points listed below.

If you call for service and there is nothing wrong with your washing machine, you will have to pay for the service call.

You will have to pay even when your washing machine is under warranty. Before you call for service, check the points in the table below.

Problem	Display Code	Possible Causes	What to do
Machine not working.		Power not switched on.	Switch on power point.
		No electricity supply through the power point.	Check power point with another appliance.
		Machine not switched on.	Press power switch on at the back of a washing machine.
	E10	Water taps not turned on.	Turn on taps.
	EFO	Out of balance switch off.	Open lid, redistribute load and close lid.
	Ld	Lid not fully closed.	Close lid.
Machine has washed load but will not spin. Water in washbowl.	EFO	Out of balance.	Open lid, redistribute load, close lid.
		Too much suds causing motor temperature overload.	Wait a short while, the wash will continue. In future, reduce detergent dose or use low sudsing (front load) detergent.
	Ld	Lid not fully closed.	Close lid.
	E20	Drain hose blocked.	Check drain hose for blockage.
Will not fill with water.	E10	Water taps not turned on Inlet hoses blocked.	Turn taps on. Clean tap filters/washers.
Water flowing into washbowl indefinitely.	E10	Drain hose too low.	Raise drain hose or fit a syphon break. Refer to installation instructions for correct positioning of hose.
Machine goes out of balance or vibrates excessively when spinning.	EFO	Machine not level.	Make the machine level.
		Levelling feet not adjusted.	Adjust feet to touch the floor.
		Clothes not evenly distributed.	Redistribute clothes evenly.
		Too much water for load size.	
Water on floor.		Loose inlet hose connections.	Check connections at taps and rear of machine.
		Incorrect water level for size of load.	Use low water level.
		Condensation from hot water.	
Clothes still dirty after wash program.		Not enough or no detergent.	Check detergent use and rewash clothes.
		Too many clothes in load.	Remove some clothes and rewash.
		Incorrect wash program or temperature selected.	Reselect program or temperature and rewash.
		Incorrect water level selected.	Use a higher water level.
Scraping noise on spin.		Bra wire or other thin items caught between inner and outer washbowls.	If the item is visible, remove it with pliers. Use a wash bag in future.
Humming, clicking and other noises.		Bowl rotation at start of wash.	Normal noise.
		Brake activation when stopping after spin.	Normal noise.
Detergent residue.		Overloaded laundry.	Put appropriate load in washer.
		Cold water temperature less than 20°C.	Correct supply water temperature.
		Detergent overdosage.	Check detergent use and rewash clothes.
Bad smell or mold on clothes.		Lint filter not cleaned.	Clean lint filter.
Machine not working.	EHO	Power supply not stable.	Wait until the power supply is stable.

OTHER DIAGNOSTIC HELP AND A GUIDE FOR WHEN YOU SHOULD CALL FOR SERVICE

If you are having a problem with your washing machine, make sure you have followed **ALL** of the instructions on page 31 in the “What to do” column before calling for service.

Description	Display Code	Customer action (Summary)
Not filling with water.	E10	<p>Make sure both wall taps are on and hose filters are not blocked.</p> <p>Raise drain hose if water is flowing out of drain hose.</p> <p>Press Start/Pause to continue the wash.</p> <p>If problem remains, call Service.</p>
Flood.	E30	<p>If the water is pouring onto the floor, turn OFF both wall taps.</p> <p>Wait a few minutes to see if the fault is corrected. If not, call Service.</p>
Draining problem.	E20	<p>Wait a few minutes to see if the fault is corrected. If not, press the Start/Pause touchpad and hold it for 1.2 second to enter pause mode then check the drain hose for blockage.</p> <p>Press Start/Pause to continue the wash.</p> <p>If problem remains, call Service.</p>
Loss of water, while washing.	E10	<p>If water level in wash bowl is low and water is flooding the floor, turn Program Selector Knob to Spin position, then press Start/Pause To Pause.</p> <p>Should this make things worse, press the power button off (some models) and call Service.</p> <p>Press Start/Pause to continue the wash.</p>
Water level problem.	E30	<p>Wait, this fault may clear itself.</p> <p>If not, turn Program Selector Knob to Spin position, then press Start/Pause to drain the wash bowl.</p> <p>If this problem is repeated, call Service.</p>
Motor fault.	E50	<p>Wait, this fault may clear itself.</p> <p>If not, turn Program Selector Knob to Spin position to drain the wash bowl.</p> <p>If this problem is repeated, call Service.</p>
Lid can't lock / can't unlock	E40	<p>If this problem is repeated, call Service.</p>
Power supply not stable.	E40	<p>Wait until the power supply is stable.</p>
Communication loss.	E91	<p>turn the machine off and on again</p>

* This product has auto load sensing feature to select optimum amount of water to suit the cloth load which might seem lower than conventional machine. This is normal condition.

10. ENVIRONMENT CONCERNS

Packaging materials



The materials marked with the symbol  are recyclable.

>PE<=polyethylene

>PS<=polystyrene

>PP<=polypropylene

This means that they can be recycled by disposing of them properly in appropriate collection containers.

Old machine

Use authorised disposal sites for your old appliance. Help to keep your country tidy!



The symbol  on the product or on its packaging indicates that this product may not be treated as household waste.

Instead it shall be handed over to the applicable collection point for the recycling of electrical and electronic equipment.

By ensuring this product is disposed of correctly, you will help prevent potential negative consequences for the environment and human health, which could otherwise be caused by inappropriate waste handling of this product.

For more detailed information about recycling of this product, please contact your local city office, your household waste disposal service or the shop where you purchased the product.

Ecological hints

To save water, energy and to help protect the environment, we recommend that you follow these tips:

- Normally soiled laundry may be washed without prewashing in order to save detergent, water and time (the environment is protected too!).
- The machine works more economically if it is fully loaded.
- With adequate pre-treatment, stains and limited soiling can be removed; the laundry can then be washed at a lower temperature.
- Measure out detergent according to the water hardness, the degree of soiling and the quantity of laundry being washed.

NOTE



This document sets out the terms and conditions of the product warranties for Simpson Appliances. It is an important document. Please keep it with your proof of purchase documents in a safe place for future reference should there be a manufacturing defect in your Appliance. This warranty is in addition to other rights you may have under the Australian Consumer Law.

1. In this warranty:

- (a) 'ACL' or 'Australian Consumer Law' means Schedule 2 to the Competition and Consumer Act 2010;
- (b) 'Appliance' means any Electrolux product purchased by you and accompanied by this document;
- (c) 'ASC' means Electrolux's authorised serviced centres;
- (d) 'Simpson' is the brand controlled by Electrolux Home Products Pty Ltd of 163 O'Riordan Street, Mascot NSW 2020, ABN 51 004 762 341 in respect of Appliances purchased in Australia and Electrolux (NZ) Limited (collectively "Electrolux") of 3-5 Niall Burgess Road, Mount Wellington, in respect of Appliances purchased in New Zealand;
- (e) 'Warranty Period' means the period specified in clause 3 of this warranty;
- (f) 'you' means the purchaser of the Appliance not having purchased the Appliance for re-sale, and 'your' has a corresponding meaning.

2. Application: This warranty only applies to new Appliances, purchased and used in Australia or New Zealand and is in addition to (and does not exclude, restrict, or modify in any way) other rights and remedies under a law to which the Appliances or services relate, including any non-excludable statutory guarantees in Australia and New Zealand.

3. Warranty Period: Subject to these terms and conditions, this warranty continues for in Australia for a period of 24 and in New Zealand for a period of 24 following the date of original purchase of the Appliance.

- Inverter motor – Further 8 years parts only

4. Repair or replace warranty: During the Warranty Period, Electrolux or its ASC will, at no extra charge if your Appliance is readily accessible for service, without special equipment and subject to these terms and conditions, repair or replace any parts which it considers to be defective. Electrolux may, in its absolute discretion, choose whether the remedy offered for a valid warranty claim is repair or replacement. Electrolux or its ASC may use refurbished parts to repair your Appliance. You agree that any replaced Appliances or parts become the property of Electrolux.

5. Travel and transportation costs: Subject to clause 7, Electrolux will bear the reasonable cost of transportation, travel and delivery of the Appliance to and from Electrolux or its ASC. Travel and transportation will be arranged by Electrolux as part of any valid warranty claim.

6. Proof of purchase is required before you can make a claim under this warranty.

7. Exclusions: You may not make a claim under this warranty unless the defect claimed is due to faulty or defective parts or workmanship. This warranty does not cover:

- (a) light globes, batteries, filters or similar perishable parts;
- (b) parts and Appliances not supplied by Electrolux;
- (c) cosmetic damage which does not affect the operation of the Appliance;

- (d) damage to the Appliance caused by:
 - (i) negligence or accident;
 - (ii) misuse or abuse, including failure to properly maintain or service;
 - (iii) improper, negligent or faulty servicing or repair works done by anyone other than an Electrolux authorised repairer or ASC;
 - (iv) normal wear and tear;
 - (v) power surges, electrical storm damage or incorrect power supply;
 - (vi) incomplete or improper installation;
 - (vii) incorrect, improper or inappropriate operation;
 - (viii) insect or vermin infestation;
 - (ix) failure to comply with any additional instructions supplied with the Appliance;

In addition, Electrolux is not liable under this warranty if:

- (a) the Appliance has been, or Electrolux reasonably believes that the Appliance has been, used for purposes other than those for which the Appliance was intended, including where the Appliance has been used for any non-domestic purpose;
- (b) the Appliance is modified without authority from Electrolux in writing;
- (c) the Appliance's serial number or warranty seal has been removed or defaced.

8. How to claim under this warranty: To enquire about claiming under this warranty, please follow these steps:

- (a) carefully check the operating instructions, user manual and the terms of this warranty;
- (b) have the model and serial number of the Appliance available;
- (c) have the proof of purchase (e.g. an invoice) available;
- (d) telephone the numbers shown below.

9. Australia: For Appliances and services provided by Electrolux in Australia: Electrolux goods come with guarantees that cannot be excluded under the Australian Consumer Law. You are entitled to a replacement or refund for a major failure and for compensation for any other reasonably foreseeable loss or damage. You are also entitled to have the Appliance repaired or replaced if the Appliance fails to be of acceptable quality and the failure does not amount to a major failure. "Acceptable quality" and "major failure" have the same meaning as referred to in the ACL.

10. New Zealand: For Appliances and services provided by Electrolux in New Zealand, the Appliances come with a guarantee by Electrolux pursuant to the provisions of the Consumer Guarantees Act, the Sale of Goods Act and the Fair Trading Act. Where the Appliance was purchased in New Zealand for commercial purposes the Consumer Guarantee Act does not apply.

11. Confidentiality: You accept that if you make a warranty claim, Electrolux and its agents including ASC may exchange information in relation to you to enable Electrolux to meet its obligations under this warranty.

Important Notice

Before calling for service, please ensure that the steps listed in clause 8 above have been followed.

<p>FOR SERVICE or to find the address of your nearest authorised service centre in Australia PLEASE CALL 13 13 49 <small>For the cost of a local call (Australia only)</small></p>	<p>AUSTRALIA ELECTROLUX HOME PRODUCTS 163 O'Riordan Street, Mascot NSW 2020 electrolux.com.au</p>	<p>FOR SPARE PARTS or to find the address of your nearest spare parts centre in Australia PLEASE CALL 13 13 50 <small>For the cost of a local call (Australia only)</small></p>
<p>FOR SERVICE or to find the address of your nearest authorised service centre in New Zealand PLEASE CALL 0800 10 66 10 <small>(New Zealand only)</small></p>	<p>NEW ZEALAND ELECTROLUX (NZ) Limited 3-5 Niall Burgess Road, Mount Wellington electrolux.co.nz</p>	<p>FOR SPARE PARTS or to find the address of your nearest spare parts centre in New Zealand PLEASE CALL 0800 10 66 20 <small>(New Zealand only)</small></p>



