

Optical Zoom Camera

User Manual (Model No.: DC150RCI)

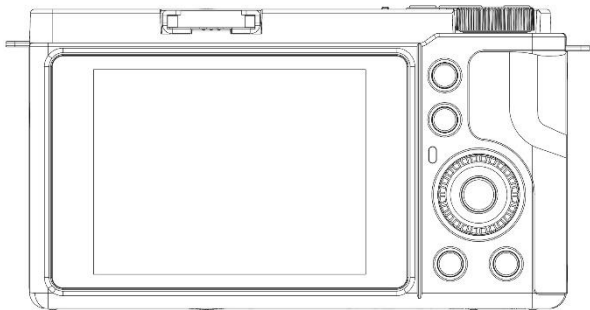

Content

Tips before Use	2
Functions Description	2
1. Product Appearance	3
2. Keys and Functions Explanation	5
Product Specifications	6
Camera Operations	8
1. Installation of Battery and TF Card	8
2. Preview Screen	9
3. Photo Mode	10
4. Camera Settings	11
5. Photography Settings	11
6. Video Settings	13
7. System Settings	13
8. Playback Settings	14
Packaging List	15
App usage	15
1. Downloading VD Cam APP	15
2. Connecting Wi-Fi	15
Connection & Charging	16
1. Battery Charging	16
2. Connecting to Computer	17
3. Connecting to HD TV	18
Precautions:	18

Tips before Use

Thank you for choosing our product. To ensure optimal usage and satisfaction, please carefully review the following instructions.

1. This product is a high-definition digital camera with optical zoom capabilities.
2. The Wi-Fi name for this product is DC150RCI_XXXXXX, with the default password set to 12345678.
3. This product supports TF cards with a maximum capacity of 256GB. For optimal video recording performance, we recommend using a U3 high-speed card from a reputable brand, featuring a minimum read speed of 100Mb/s and a write speed of 60Mb/s or higher.
4. Format the TF card using the camera for the first-time use, and remember to back up important files on the TF card.
5. The images in this user manual are provided for reference purposes and may not precisely match the actual product. Please refer to the actual product functionality for accurate details.

Functions Description

1. Product Appearance

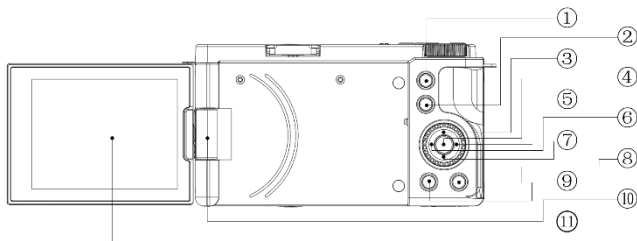

- | | |
|--|--------------------------------|
| 1) Playback button | 6) Macro function shortcut key |
| 2) AE/AF LOCK button | 7) Timer shortcut key |
| 3) EV (Exposure Value) function shortcut key | 8) Delete button |
| 4) Confirm button | 9) Menu button |
| 5) LED fill function shortcut key | 10) Indicator light |
| | 11) Rotating shaft |

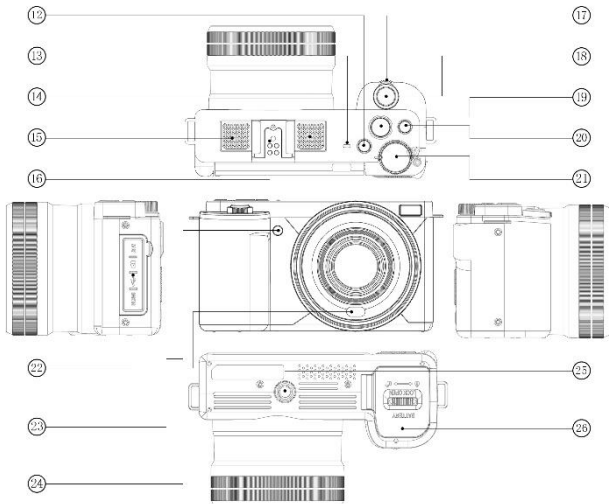

- 12) ISO Function button
- 13) Power on/off Switch
- 14) MIC
- 15) Speaker
- 16) Expansion port
- 17) W/T button
- 18) Shutter button
- 19) Record button
- 20) DISP (Display) button

- 21) Mode dial
- 22) Power indicator light
- 23) MIC Interface / USB Interface / HD Interface / TF card
- 24) Focusing assist light
- 25) LED fill light
- 26) Tripod mounting hole
- 27) Battery cover

2. Keys and Functions Explanation

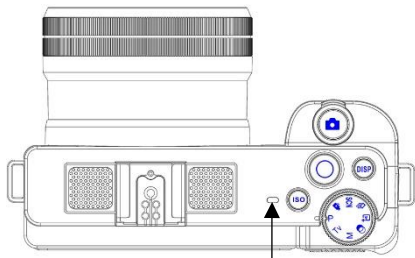

Indicator Lights:

【Red Indicator Light】 Stays on when the battery is charging and goes off when the battery is fully charged.

【Green Indicator Light】 Stays on when the device is powered on; flashes slowly during recording; When taking a photo, snap a picture, and the green light flashes once.

【Mode Dial】 Photography Mode Dial: In the preview screen, manually adjust the dial to the left or right to select the desired mode for taking photos.

M -- Manual Exposure

 --Video recording mode

Tv -- Shutter Priority



P -- Program Auto Exposure

SCN -- Scene Mode









 --Continuous Shooting Mode

 -- Intelligent Scene Mode

 -- Filter Mode

T/W	zoom in/out	<ol style="list-style-type: none"> 1.During real-time preview, zoom in/out by adjusting left and right. 2.In manual focus mode, adjust focus clarity by moving left and right. 3.During playback, zoom in/out images by adjusting left and right.
	Shutter Button	During real-time preview, lightly press for the first stage to focus, and press firmly for the second stage to take a photo.
	Record Button	Quickly start/Stop recording.
DISP	DISP Button	Cycle through three screen display modes: normal mode, simplified mode, and screen-off mode.
	Power Button	Short press to turn on or off the device



	Playback Button	<ol style="list-style-type: none"> 1. Enter playback 2. Return to the previous level.
	AE/AF LOCK	Used for AE (Auto Exposure) lock and AF (Auto Focus) focus lock during photography.
	EV Function Button	<ol style="list-style-type: none"> 1. Quickly access the EV adjustment interface; 2. Up button; 3. Pause or resume recording during video capture.
	Macro Function Button	<ol style="list-style-type: none"> 1. Quickly access the focus mode setting. 2. Left button.
	Flash Function Button	<ol style="list-style-type: none"> 1. Quickly access the LED fill mode setting. 2. right button.
	Timer Shortcut Key	<ol style="list-style-type: none"> 1.Quickly access the timer setting. 2.Down button.
	Confirm Button	confirm selections.
	Menu Button	Open / Close Menu Settings
	Delete Button	<ol style="list-style-type: none"> 1.Quickly enter the delete interface. 2.Delete in Playback Mode

Product Specifications

Model	DC150RCI
Screen	2.88"IPS TFT
Len	f=4.9~49mm wide: 0.1m~INF Tele: 1.5m~INF
Optical Zoom	10X
Digital Zoom	2X
Photo Resolution	64M /32M/16M/8M
Video Resolution	UHD(4K):2880*2160(24fps) QHD(2K): 2560*1440(30fps) FHD(1080P):1920*1080(30fps) HD(720P):1280*720(60fps) VGA: 640*480(120fps)
WIFI	Supports, APP: VD CAM
Metering Mode	Multi, Center, spot
Focus Mode	AF/MF (Auto Focus/Manual Focus)
MIC	Built-in/External MIC
Photo Mode	P (Program Auto Exposure)/TV (Shutter Priority) M (Manual Exposure)/Filters Mode/A+ (Intelligent Mode) Continuous Mode/SCN (Scene Mode)
Built-in Features	Electronic Image Stabilization, Focus Assist Lamp, Fill light, Hot Shoe, Speaker
Other Features	Display flip, Facial recognition, burst mode (3 shots in a row), selfie mode (with 2-second, 5-second, 10-second timer), AE lock.
Output Interface	HDMI, Type-C, 3.5mm Headphone Jack (External MIC), 2.5mm Headphone Jack (External Remote Controller - optional)
Memory Card	External TF Card Slot (Supports up to 256GB)
Battery	Dedicated Lithium Battery 3.7V

Camera Operations

1. Installation of Battery and TF Card

- (1) This camera uses a high-capacity rechargeable external Dedicated lithium battery.

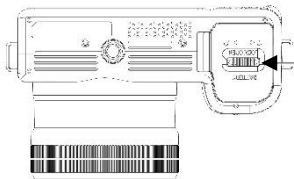

Slide open the battery cover carefully. Insert the battery, ensuring the polarity direction matches the icons inside the battery compartment. When you hear a click sound, it indicates the installation is complete.

- (2) The memory card supports a maximum of 256GB storage capacity. To ensure normal video recording, please use a branded authentic U3 high-speed card (with a read speed of 100Mb/s and a write speed of over 60Mb/s).

Open the rubber cover. Carefully insert the TF card, aligning it with the polarity direction indicated inside the TF card slot. When you hear a click, it means the TF card is installed.

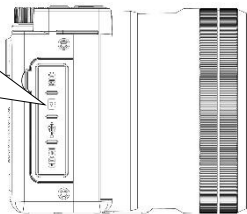



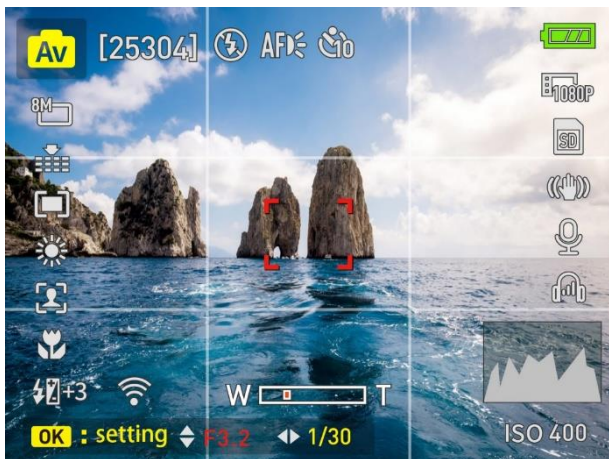

Note:

- Format the TF card using the camera for the first-time use, and remember to back up important files on the TF card.
- Do not remove the TF card during recording, as it may cause data loss or damage to the device.











2. Preview Screen

[25304]	Display the number of photos that can be stored and the current available space on the TF card.
	Display the current set timer for timed photography. Providing four choices: Off, 2 seconds, 5 seconds, and 10 seconds.
	Display the current set EV (Exposure Value). Providing seven choices: +3.0, +2.0, +1.0, +0.0, -1.0, -2.0, -3.0.
	Display the current set LED fill light mode. Providing four choices: Macro (Auto), Macro (Manual), AF, MF (Manual).
	Display the current set flash mode. Providing three choices: Auto, Force On, Force Off.
	Display the TF card status. Three states: Inserted, Not Inserted, and Write Protection.

3. Photo Mode

Under the preview screen, slide the mode dial left or right to select the appropriate mode for taking photos.

Icon	Mode Instructions	Function Explanation	Operation instructions
	Manual Exposure	Manually adjust aperture and exposure time	Press OK button → Use up and down buttons to adjust aperture → Use left and right buttons to set exposure duration → OK button to confirm
	Video mode	Enter video recording interface	/
	Shutter Priority	Manually set exposure time	OK button → Use left and right buttons to adjust exposure time → OK button to confirm
	Program Auto	Automatically adjust aperture and exposure time	/
	Scene Mode	Offering 10 scene selections	1. Use left and right keys to select scene → Press OK button to confirm. 2. Press Menu button → Select scene → Use left and right keys to choose scene → Press OK button to confirm.
	Continuous Mode	Capture three photos in quick succession	/
	Intelligent Mode	The camera automatically selects the optimal settings for the current scene	/
	Filter Mode	Provide 11 filter modes	1. Use left and right keys to select filter mode → Press OK button to confirm. 2. Press Menu button → Select filter effects → Use left and right keys to choose filter mode → Press OK button to confirm.

4. Camera Settings

You can make custom settings for the camera. After the camera is turned on, press the menu button to open the menu. The menu will start under Photo Settings. To move to Video and System settings press the Right/Flash key.

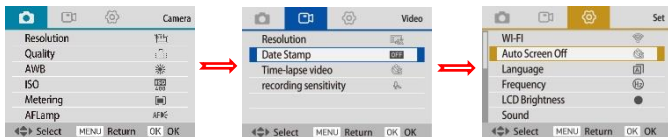

Note:

The settings may vary depending on the mode selected via the mode dial.

5. Photography Settings

Resolution	64M (9200*6900) 32M (6480*4860) 16M (4608*3456) 8M (3264*2448)	This setting is not supported in continuous mode.
Quality	Super Fine, Fine, Normal	This setting is not supported in Filter Mode.



AWB	Auto, Daylight, Cloudy, Tungsten, Fluorescent	This setting is not supported in Scene Mode, continuous Mode, Filter Mode, or Intelligent Scene.
ISO	Auto,ISO100,ISO200,ISO400, ISO800,ISO1600,ISO3200	This setting is not supported in Scene Mode, continuous Mode, Filter Mode, TV/M Mode, or Intelligent Scene.
Metering	Multi, Center, Spot Model	This setting is not supported in continuous Mode, Scene Mode, Filter Mode, or Intelligent Scene.
AF Lamp	Auto, Turn On/Turn Off	This setting is not supported in continuous Mode, Filter Mode, or Scene Mode.
AE-L/AF-L	AE-L (Auto Exposure Lock) AF-L (Auto Focus Lock) AE-L&AF-L (Auto Exposure and Auto Focus Lock)	This setting is not supported in Scene Mode, continuous Mode, Filter Mode, or Intelligent Scene Mode.
Grid Line	Turn On/Turn Off	
Anti-shake	Turn On/Turn Off	
Date Stamp	Turn On/Turn Off	
Quick Review	Off, 2 seconds, 5 seconds	
Color	Only available in Filter mode. Provides 11 color options	Only available in Filter Mode.
Scene Selection	Only available in Scene mode. Provides 10 scene modes	Only available in Scene Mode.

Video Resolution	4K (2880*2160) 2K (2560*1440) 1080P(1920*1080/60fps) 1080P(1920*1080/30fps) 720P
Date Stamp	Turn On/Turn Off
Time-lapse video	Off,1 second, 3 seconds, 5 seconds
Recording	Soft, Normal, Strong

6. Video Settings

sensitivity	
-------------	--

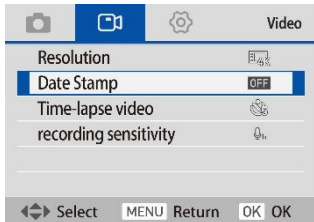

7. System Settings

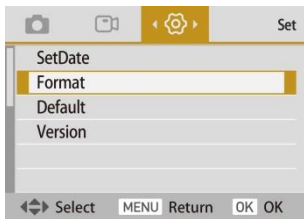

Wi-Fi	Turn on Wi-Fi Name: DC15ORCI+SSID, default password is 12345678 Press the OK button to manually turn off the Wi-Fi hotspot. Note: if not successfully connected within 2 minutes, the camera will automatically turn off the Wi-Fi hotspot.
Auto Off	Off, 3 minutes, 5 minutes, 10 minutes
Language	Provides 14 language options to choose from.
Frequency	50Hz、60Hz
Sound	Turn On/Off: Power-on sound, Shutter sound, Operating volume

Set Date	Year, Month, Date, Hour, Minute, Second。 Note: Synchronize the date and time with the smartphone system when connected to Wi-Fi
Format	Cancel or Ok Note: Clear all files from the TF card. Before performing this operation, please backup any important files from the TF card.
Default	Cancel or Ok Note: Restore factory settings
Version	Software Version Number

8. Playback Settings

Press the playback button to enter the playback settings interface.

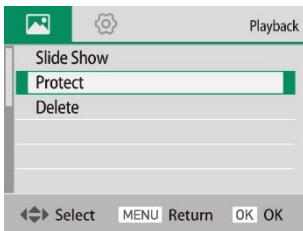

【Slide show】 : This feature allows you to start a slideshow of photos. You can set the interval duration between slides and whether the slideshow should loop.

【Protect】 : This function is used to lock photos. Once a photo is locked, it cannot be deleted on the camera unless it is unlocked. There are four options: Lock Current, Unlock Current, Lock All, and Unlock All.

【Delete】 : This function is used to delete photos and videos. There are two options: Delete

Current Photo and Delete All Files.

Packaging List

HD Camera	1pcs
NP-120 battery	1pcs
TYPE-C USB cable	1pcs
HD-D cable	optional
lanyard	optional
tripod	optional

App usage

1. Downloading VD Cam APP

Please use the browser to scan the QR code or search for "VD Cam(Video Dimension Camera)" on App Store. For Android users, search for "VD Cam" on Google Play.



2. Connecting Wi-Fi

- ① Power on the device.
- ② Press the menu button → Right-click to select the settings menu bar → Wi-Fi options → Select to enable Wi-Fi hotspot.
- ③ Open Wi-Fi on your smartphone, and then search for the Wi-Fi name DC150RCI-SSID number, enter the default password: 12345678.
- ④ Open the app, touch connect camera icon.

- ⑤ After connecting, you can adjust settings via your phone, start/stop recording, take photos, view, and download videos and photos.

Notes:

- To ensure the normal operation of the camera, it is not recommended to modify the Wi-Fi name and password.
- There should be no obstacles between the phone and the camera; the maximum connection distance is about 10 meters.
- After the camera is connected to the phone, you can press the OK button to turn off the Wi-Fi hotspot.
- Other functions of the camera buttons cannot be used.
- If there is no connection with the phone within 2 minutes, the camera will automatically turn off the Wi-Fi hotspot.
- If using VPN, switch it off before connecting to the Wi-Fi.

Connection & Charging

1. Battery Charging

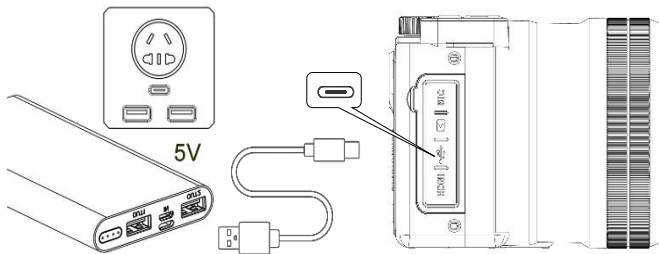

- ① Connect the USB cable to the charging port on the side of the camera.
- ② Connect the other end of the USB cable to a suitable USB power adapter or power bank with a 5V/2A output.

- ③ While charging, the camera indicator light will turn red.
- ④ When charging is complete, the light will go out. Charging takes approximately 2-3 hours.

Note:

It is recommended to charge the battery once every 3 months when the camera is not used for a long time. Then discharge the battery to maintain battery life.

2. Connecting to Computer

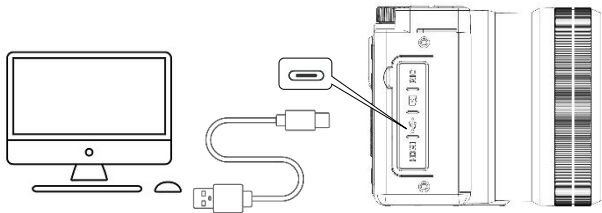

The camera can be used as an MSDC or PC camera.

- ① Power on the device.
- ② Connect the camera and computer with a USB cable.
- ③ The MSDC & PC camera options will be displayed on the camera screen, use the up and down keys to select, then press the OK button to confirm.

3. Connecting to HD TV

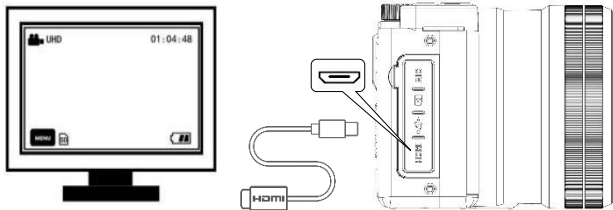

1. Keep the camera powered on.
2. Connect the HD cable to the HD Out port on the camera.
3. Connect the other end of the cable to a High-Definition television.
4. Set the TV's video input source to HDMI to display the preview on the TV.

Precautions

1. Do not expose the device to rain or damp environments.
2. Do not place items containing liquid, such as vases, on the device.
3. Do not expose the battery to excessive heat, sunlight, smoke, fire, or flames.
4. Do not crush or puncture the battery pack. Do not subject the battery pack to any impact or external force, such as hammering, dropping, or stepping on. Do not short-circuit, and do not allow metal objects to contact the battery terminals.
5. Do not expose to temperatures exceeding 60°C (140°F), such as direct sunlight or leaving it in a car parked in the sun. Do not incinerate or dispose of improperly.

FCC Warning

This device complies with Part 15 of the FCC Rules. Operation is subject to the following two conditions:

(1) This device may not cause harmful interference, and (2) this device must accept any interference received, including interference that may cause undesired operation.

NOTE 1: This equipment has been tested and found to comply with the limits for a Class B digital device, pursuant to part 15 of the FCC Rules. These limits are designed to provide reasonable protection against harmful interference in a residential installation. This equipment generates, uses and can radiate radio frequency energy and, if not installed and used in accordance with the instructions, may cause harmful interference to radio communications. However, there is no guarantee that interference will not occur in a particular installation. If this equipment does cause harmful interference to radio or television reception, which can be determined by turning the equipment off and on, the user is encouraged to try to correct the interference by one or more of the following measures:

- Reorient or relocate the receiving antenna.
- Increase the separation between the equipment and receiver.
- Connect the equipment into an outlet on a circuit different from that to which the receiver is connected.
- Consult the dealer or an experienced radio/TV technician for help.

NOTE 2: Any changes or modifications to this unit not expressly approved by the party responsible for compliance could void the user's authority to operate the equipment.

The device has been evaluated to meet general RF exposure requirement. The device can be used in portable exposure condition without restriction.