

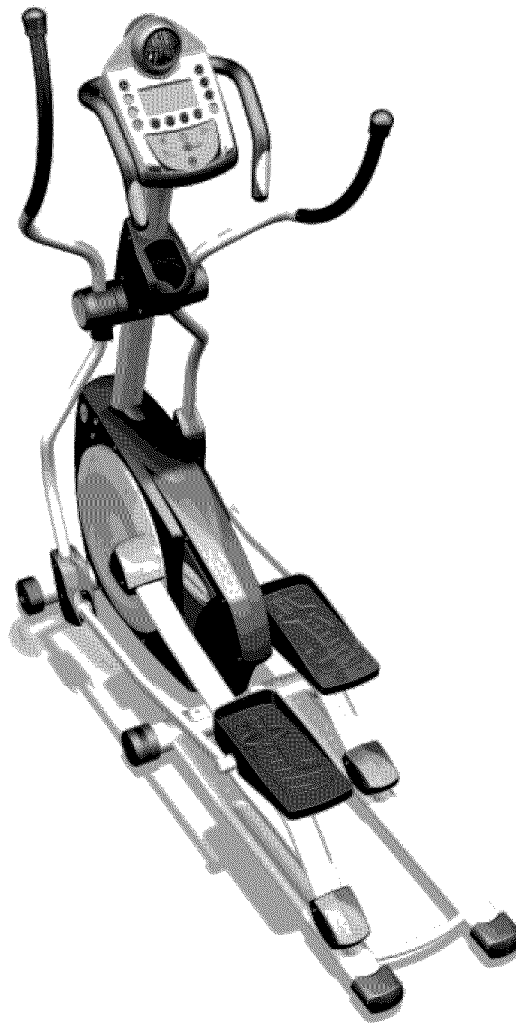

**SCHWINN FITNESS**

# Elliptical Trainer Model 438

ASSEMBLY GUIDE and  
OWNER'S MANUAL



## Congratulations

Thank you for making the Schwinn® Elliptical Trainer Model 438 a part of your exercise program. For many years to come, you will be able to rely on the quality of Schwinn's® craftsmanship and durability. We have included some general fitness guidelines for your use and hope you will find the information valuable in assisting you in your pursuit of a healthy lifestyle.

The Schwinn® 438 elliptical trainer will enable you to customize and monitor your workouts to:

- ▲ Increase your energy level
- ▲ Increase cardiovascular and aerobic fitness
- ▲ Increase lower and upper body muscle strength
- ▼ Decrease your overall percentage of body fat

Whether you are just getting started in an exercise program or are already physically fit, the Schwinn® 438 elliptical trainer is designed to be an efficient, easy, and enjoyable way to achieve an improved level of fitness. You can exercise your way to a more fit and healthy body. The on-board digital computer enables you to accurately monitor your progress by tracking time, distance, speed, calories, and strides per minute.

This Assembly Guide and Owner's Manual contains all the information you need to operate and enjoy your Schwinn® elliptical trainer. Please read the manual in its entirety before attempting to exercise on the Schwinn® 438 elliptical trainer. Pay special attention to the safety notices at the beginning of the owner's manual to avoid serious injury to yourself or damage to the equipment. Take a moment to thoroughly review the parts and hardware lists and required tools before getting started with the assembly process.

If you find any parts or hardware missing, or should you need assistance with assembling your Schwinn® Elliptical Trainer Model 438, contact Customer Service at 800-864-1270 or write to:

Nautilus, Inc.  
World Headquarters  
16400 SE Nautilus Drive  
Vancouver, Washington 98683  
USA

**Assembly Guide**

Parts Diagram.....3  
Parts List .....4  
Hardware List.....5  
Assembly Instructions.....6

**Owner's Manual**

Safeguards.....17  
Features .....19  
Operation.....20  
Maintenance .....46  
Fitness Guide .....48  
Workout Log .....57  
Warranty.....58

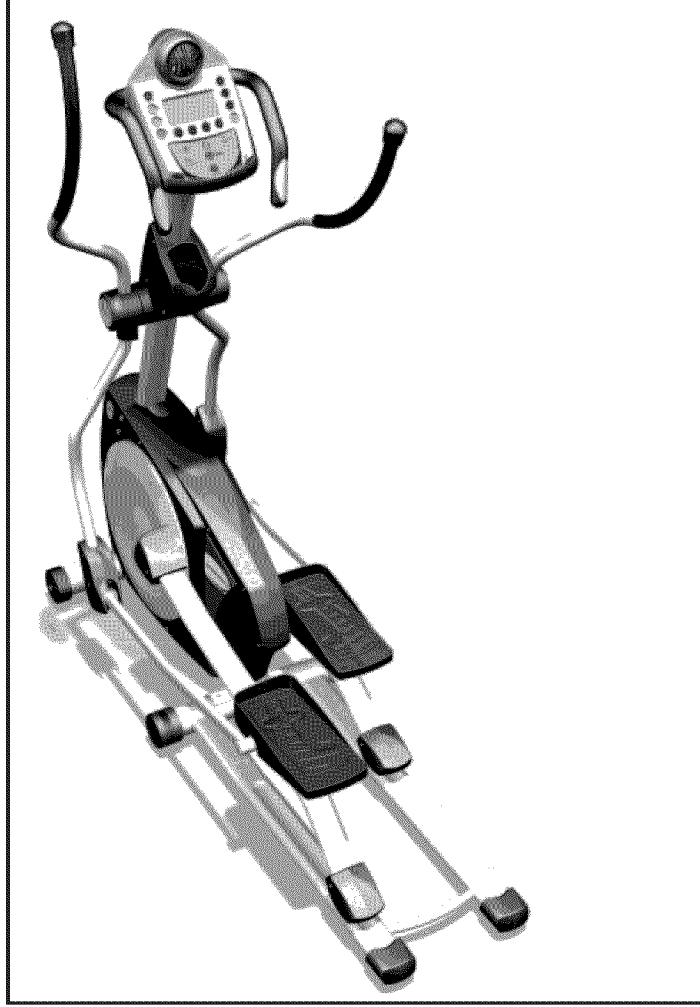

**FOR DETAILED INSTRUCTIONS AND INFORMATION ON HOW TO USE AND CARE FOR YOUR SCHWINN® ELLIPTICAL TRAINER MODEL 438, REFER TO THE OWNER'S MANUAL SECTION STARTING ON PAGE 17.**

Schwinn® Model 438



### Tools Required

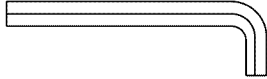
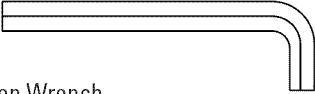
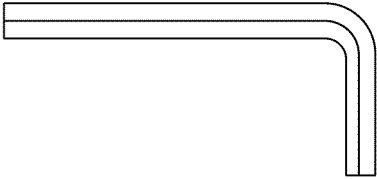

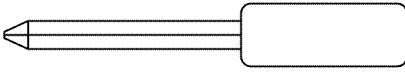



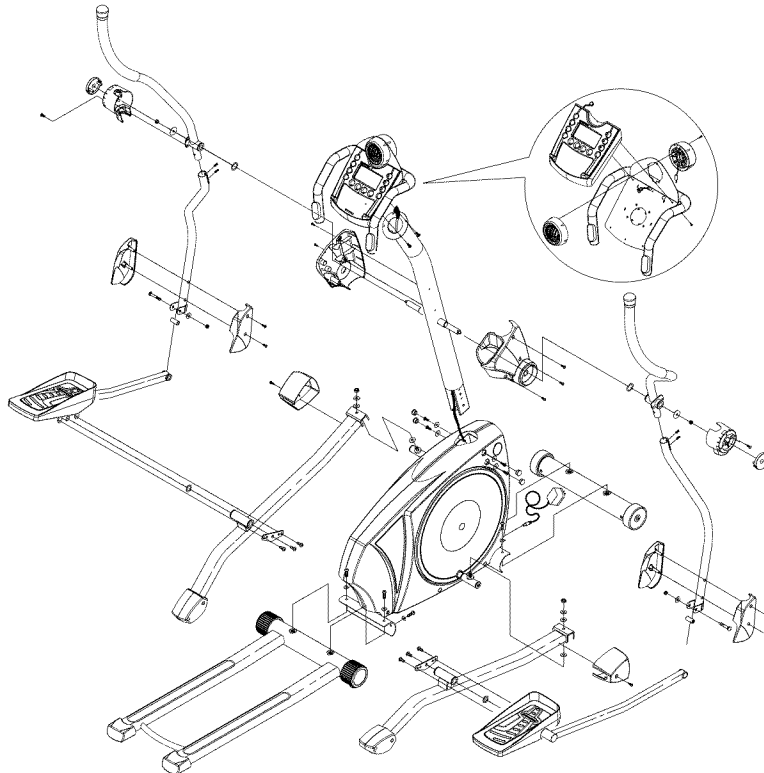

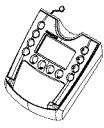

The tools below are required during the assembly of your Schwinn® 438 elliptical trainer. They are included with the product.

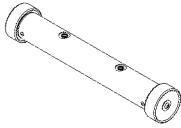
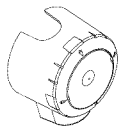

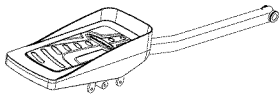
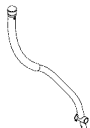
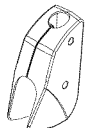

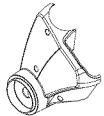

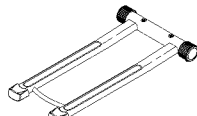
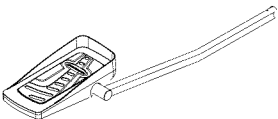

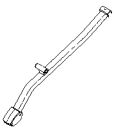
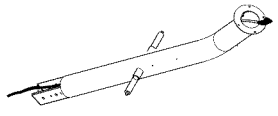
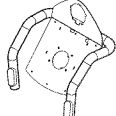
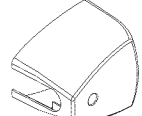
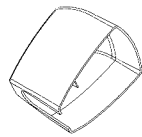
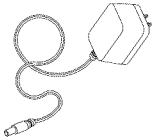
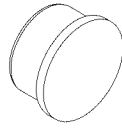

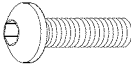
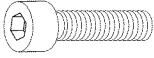
 4mm Allen Wrench	 5mm Allen Wrench
 6mm Allen Wrench	 Open End Wrench  Philips Screwdriver

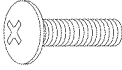
### Complete Parts Diagram

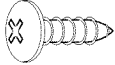

**PARTS LIST**

		
Console #2	Fan Assy #3	Front Stabilizer Assy #4
		
Handlebar Jct Cover Set #5	Lower Left Handlebar Assy #6	Left Pedal Arm Assy #7
		
Left Upper Handlebar #8	Lower Handlebar Cover Set #9	Lower Right Handlebar Assy #10
		
Left Mast Cover #12	Right Mast Cover #13	Complete Rear Rail Assy #14
		
Right Pedal Arm Assy #15	Right Upper Handlebar #16	Sub Pedal Arm Assy #17
		
Console Mast Assy #18	Complete Static Handlebar #19	Right Crank Cover #20
		
Left Crank Cover #21	AC Adaptor #23	Shroud Plug #25

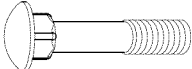
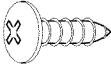
<p><b>Step #1</b></p> <div style="display: flex; justify-content: space-around;">   </div> <p>8.2x18x1.5T Curve Washer #35 (Qty 6)      8x25 Button Head Bolt #36 (Qty. 6)</p>	
<p><b>Step #3</b></p> <div style="display: flex; justify-content: space-around;">   </div> <p>8x15 Socket Cap Head Bolt #26 (Qty 4)      8.2x15x1.2T Arc Washer #43 (Qty 4)</p>	<p><b>Step #4, #5, and #10</b></p> <div style="display: flex; justify-content: center;">  </div> <p>5x8 Pan Head Screw #11 (Qty 11)</p>
<p><b>Step #6</b></p> <div style="display: flex; justify-content: space-around;">   </div> <p>12.5x25x1.0T Arc Washer #32 (Qty 4)      10.2x25x1.5T Flat Washer #33 (Qty 2)</p>	<p><b>Step #7 and #8</b></p> <div style="display: flex; justify-content: center;">  </div> <p>20.5x29x1.5T Wave Washer #27 (Qty 4)</p>
<div style="display: flex; justify-content: space-around;">   </div> <p>10x1.5 Nylon Hex Nut #34 (Qty 2)      4x16 Self-Tap Round Head Screw #41 (Qty 2)</p>	<p><b>Step #8</b></p> <div style="display: flex; justify-content: center;">  </div> <p>10.3x35x2T Flat Washer #28 (Qty 2)</p>
<p><b>Step #8 and #9</b></p> <div style="display: flex; justify-content: center;">  </div> <p>Nylon Hex Nut #29 (Qty 4)</p>	<p><b>Step #9</b></p> <div style="display: flex; justify-content: space-around;">   </div> <p>8x10 Set Screw #30 (Qty 4)      8x50 Carriage Bolt #37 (Qty 2)</p>
	<div style="display: flex; justify-content: center;">  </div> <p>4x16 Self-Tapping Round Head Screw #41 (Qty 4)</p>

**Introduction**

Read and follow each step carefully and in proper order to avoid missing any steps. Be sure to have all parts and tools on hand for a particular step before beginning assembly for that step. If you discover parts are missing, contact Customer Service at 800-864-1270.

**Step 1—Assemble the Front Stabilizer and Rear Rail Assembly**

**Parts**

- N/A Main Frame (Qty 1)
- #4 Front Stabilizer (Qty 1)
- #14 Rear Rail Assembly (Qty 1)

**Hardware**

- #35 8.2x18x1.5T Curve Washer (Qty 6)
- #36 8x25 Button Head Bolt (Qty 6)

- 1-1 Attach the Front Stabilizer (#4) to the Main Frame with two (2) Button Head Bolts (#36) and two (2) Curve Washers (#35).
- 1-2 Attach the Rear Rail Assembly (#14) to the Main Frame with four (4) Button Head Bolts (#36) and four (4) Curve Washers (#35).

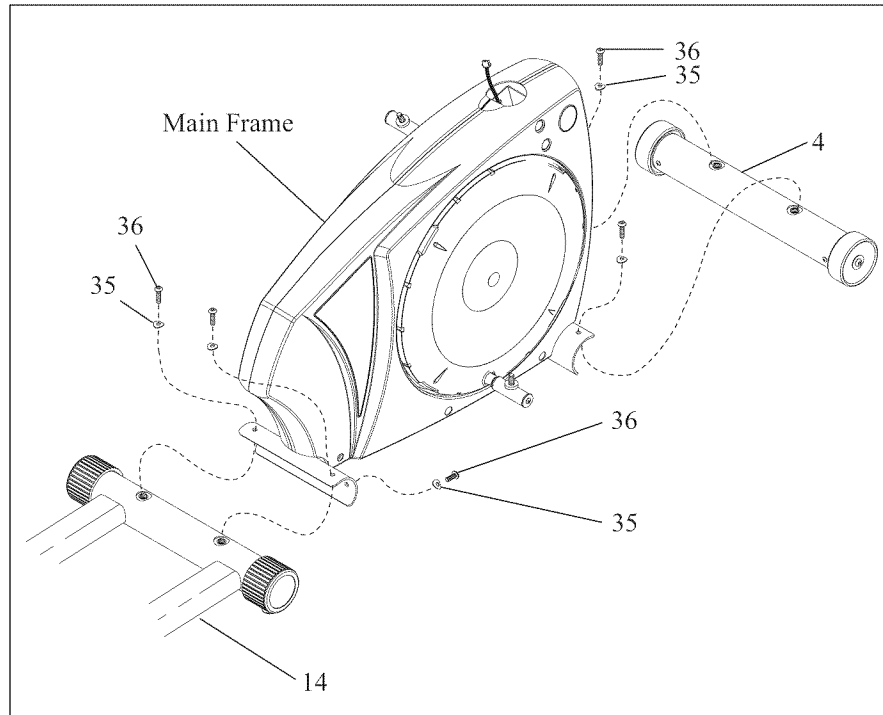

Figure A-1



## Step 2—Assemble the Console

### Parts

- #2 Console (Qty 1)
- #3 Fan Assembly (Qty 1)
- #19 Static Handlebar (Qty 1)

- 2-1 Remove the six (6) Round Head Machine Screws (#1) from the Console (#2).
- 2-2 Attach the Console (#2) to the Static Handlebar (#19) with the six (6) Round Head Machine Screws (#1) you removed in the previous step.

- 2-3 Separate the two halves of the Fan Assembly (#3) by removing the five (5) screws.
- 2-4 Place the rear half of the Fan Assembly (#3) on the back of the Static Handlebar (#19).
- 2-5 Place the front half of the Fan Assembly (#3) on the front of the Static Handlebar (#19), and reinstall the five (5) screws you removed from the Fan Assembly (#3) in step 2-3.
- 2-6 Plug the Fan Assembly (#3) into the Console (#2).

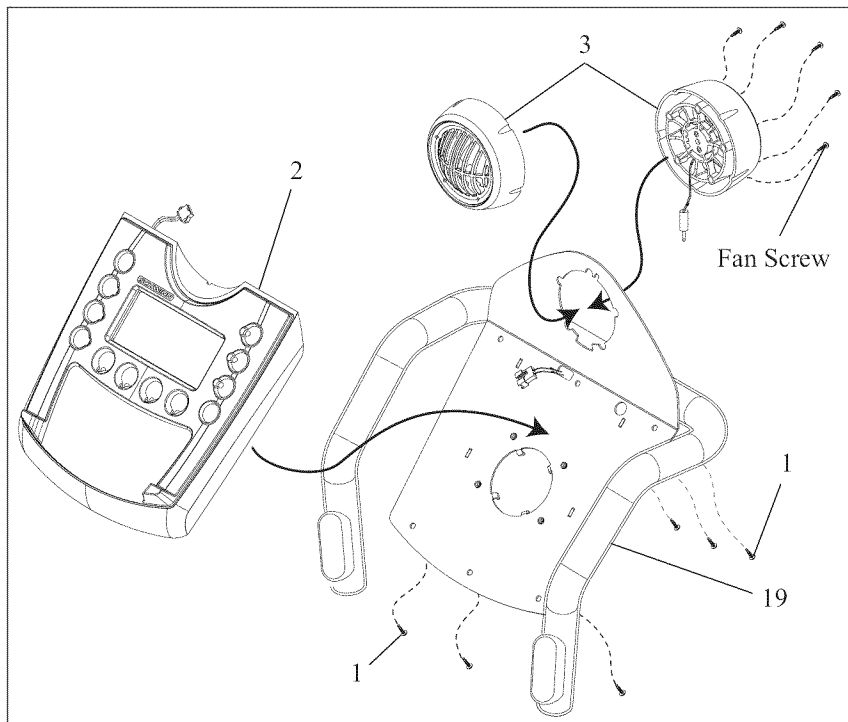

Figure A-2

### Step 3—Attach the Console Mast to the Main Frame

#### Parts

- N/A Main Frame (Qty 1)
- #18 Console Mast (Qty 1)
- #25 Shroud Plug (Qty 4)

#### Hardware

- #26 8x15 Socket Cap Head Bolt (Qty 4)
- #43 8.2x15x1.2T Arc Washer (Qty 4)

- 3-1 Securely attach the “zip tie” at the bottom of the Console Mast (#18) to the computer cable from the Main Frame, and pull the “zip tie” and attached computer cable through the Console Mast (#18) from the top.
- 3-2 Insert the Console Mast (#18) into the Main Frame, and attach with four (4) Socket Cap Head Bolts (#26) and four (4) Arc Washers (#43).
- 3-3 Place Shroud Plugs (#25) in the holes in the Main Frame.

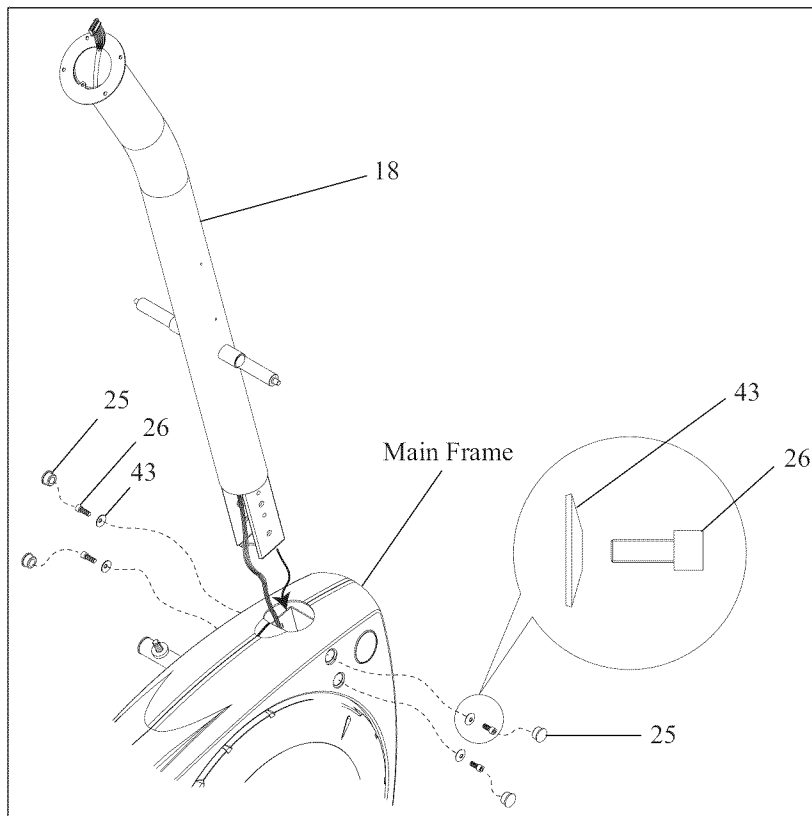

Figure A-3

### Step 4—Attach the Console to the Console Mast

#### Parts

- #2 Console (Qty 1)
- #3 Fan Assembly (Qty 1)
- #18 Console Mast (Qty 1)
- #19 Static Handlebar (Qty 1)

#### Hardware

- #11 5x8 Pan Head Screw (Qty 4)

- 4-1** Attach the Console/Fan/Static Handlebar Assembly (#2, #3, and #19) to the Console Mast (#18) with four (4) Pan Head Screws (#11).

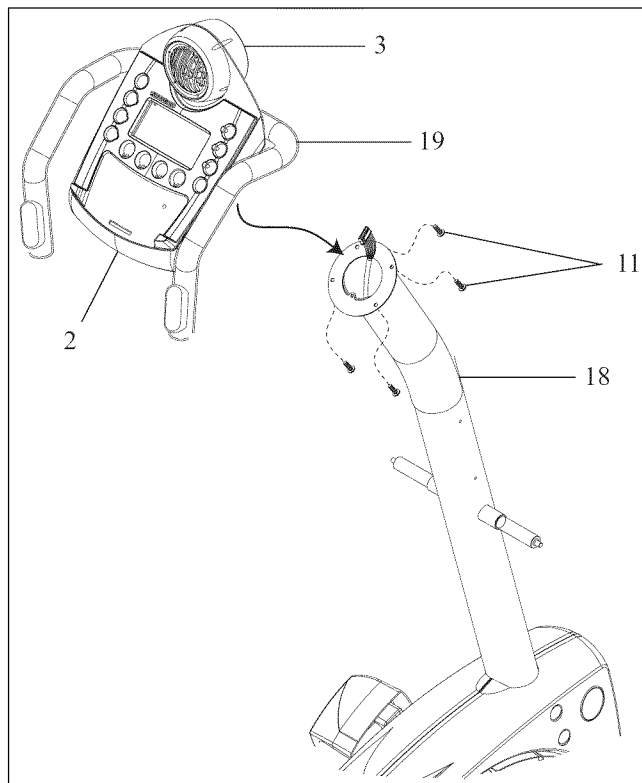

Figure A-4

**Step 5—Attach Mast Covers**

**Parts**

- #12 Left Mast Cover (Qty 1)
- #13 Right Mast Cover (Qty 1)
- #18 Console Mast (Qty 1)

**Hardware**

- #11 5x8 Pan Head Screw (Qty 5)

**5-1** Slide the Left Mast Cover (#12) over the Console Mast Pivot, and attach with two (2) Pan Head Screws (#11).

**5-2** Slide the Right Mast Cover (#13) over the Console Mast Pivot, and attach with 3 Pan Head Screws (#11).

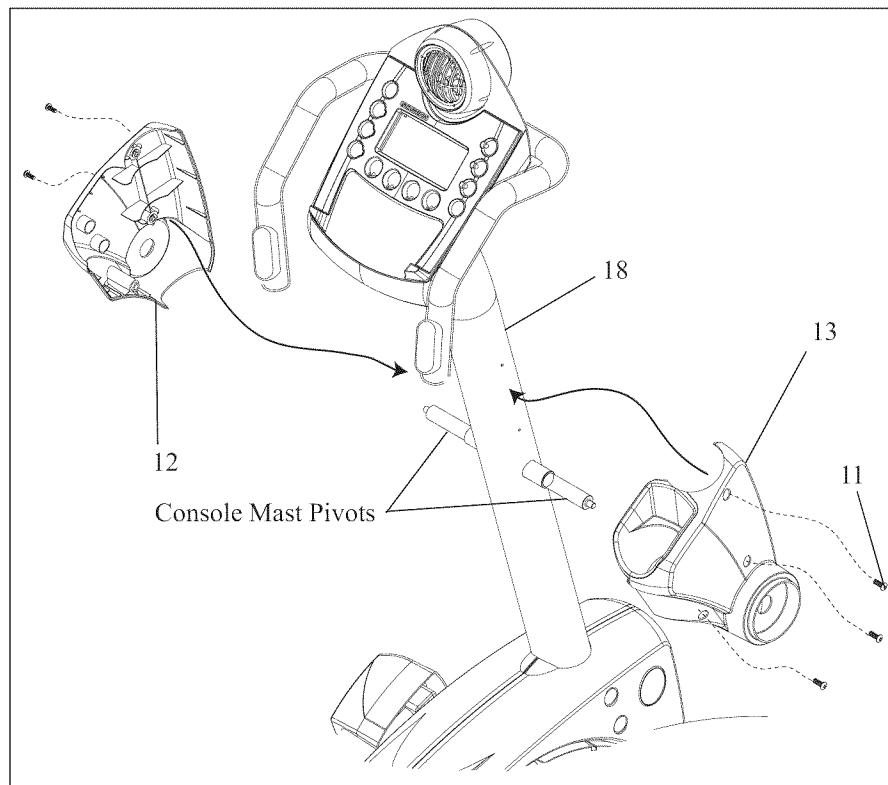

*Figure A-5*

## Step 6—Attach the Sub Pedal Arm Assemblies and Crank Covers

### Parts

- #17 Sub Pedal Arm Assy (Qty 2)
- #20 Right Crank Cover (Qty 1)
- #21 Left Crank Cover (Qty 1)

### Hardware

- #32 12.5x25x1.0T Arc Washer (Qty 4)
- #33 10.2x25x1.5T Flat Washer (Qty 2)
- #34 10x1.5 Nylon Hex Nut (Qty 2)
- #41 4x16 Self-Tapping Round Head Screw (Qty 2)

- 6-1** Place the Sub Pedal Arm Assembly (#17), two (2) Arc Washers (#32), and one (1) Flat Washer (#33) on the right Pivot Tube (#22), as shown in the figure close-up below.

- 6-2** Install the Nylon Hex Nut (#34) on the right Pivot Tube bolt.
- 6-3** Align the Wheel on the Sub Pedal Arm Assembly (#17) in the track on the Rear Rail Assembly.
- 6-4** Place the Right Crank Cover (#20) on the right Pivot Tube (#22).
- 6-5** Secure the Right Crank Cover (#20) with the Self-Tapping Round Head Screw (#41).
- 6-6** Repeat steps 6-1 through 6-5 for the left Pivot Tube using the Left Crank Cover (#21).

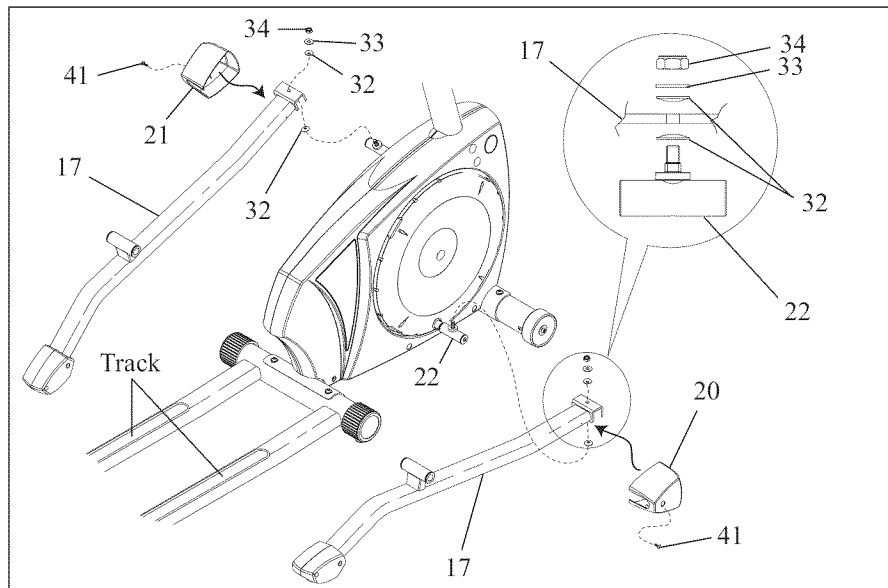

Figure A-6

### Step 7—Attach the Pedal Arm Assemblies

#### Parts

- #7 Left Pedal Arm Assembly (Qty 1)
- #15 Right Pedal Arm Assembly (Qty 1)
- #17 Sub Pedal Arm Assy (Qty 2)

#### Hardware

- #27 20.5x29x1.5T Wave Washer (Qty 2)

**7-1** Remove the two (2) 8x1.25x10 Button Head Bolts (#39), a 8x1.25x20 Button Head Bolt (#40), and a Pedal Arm Bracket (#42) from the Right Pedal Arm Assembly (#15).

**7-2** Attach the Right Pedal Arm Assembly (#15) to the Sub Pedal Arm Assembly (#17) with a Wave Washer (#27), a Pedal Arm Bracket (#42), two (2) 8x1.25x10 Button Head Bolts (#39), and a 8x1.25x20 Button Head Bolt (#40).

**7-3** Repeat steps 7-1 and 7-2 for the Left Pedal Arm Assembly (#7).

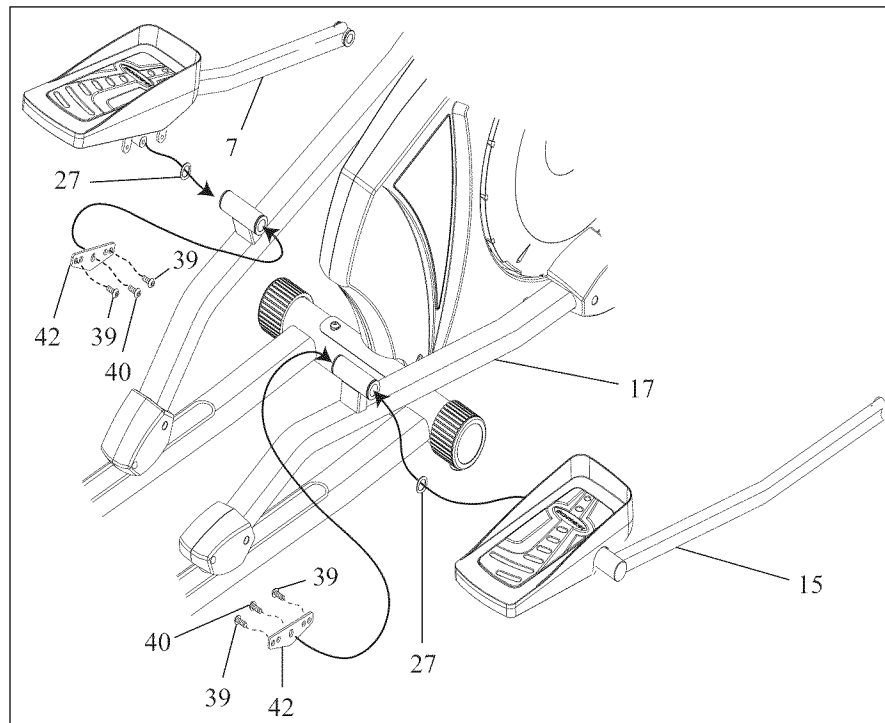

Figure A-7

### Step 8—Attach the Upper Handlebar Assemblies

#### Parts

- #8 Left Upper Handlebar (Qty 1)
- #16 Right Upper Handlebar (Qty 1)
- #18 Console Mast (Qty 1)

#### Hardware

- #27 20.5x29x1.5T Wave Washer (Qty 2)
- #28 10.3x35x2T Washer Flat (Qty 2)
- #29 Nylon Hex Nut (Qty 2)

- 8-1** Attach the Right Upper Handlebar (#16) to the Console Mast (#18) with a Flat Washer (#28), a Wave Washer (#27), and a Nylon Hex Nut (#29).
- 8-2** Repeat step 8-1 for the Left Upper Handlebar (#8).

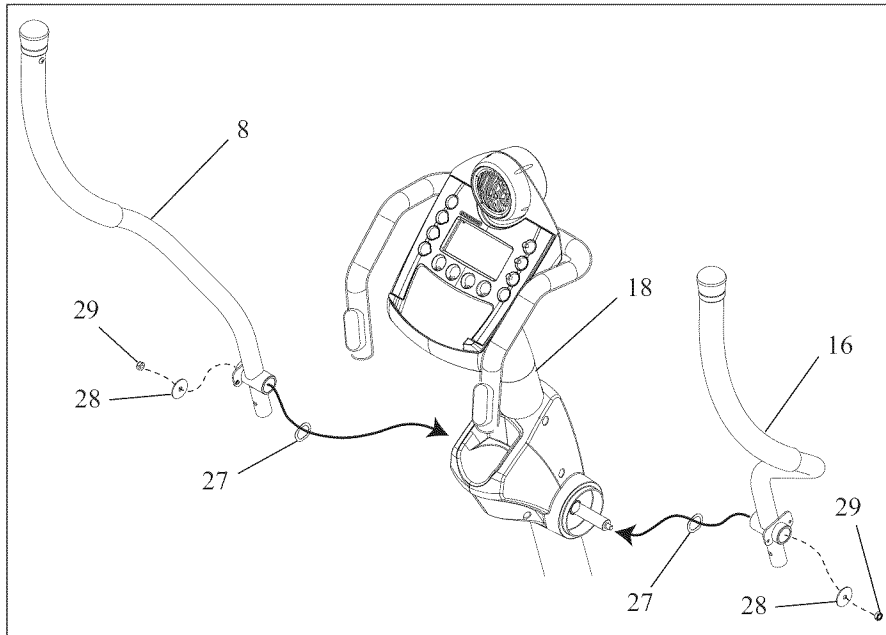

Figure A-8

**Step 9—Attach the Lower Handlebar Assemblies**

**Parts**

- #6 Lower Left Handlebar Assembly (Qty 1)
- #7 Left Pedal Arm Assembly (Qty 1)
- #8 Left Upper Handlebar (Qty 1)
- #9 Lower Handlebar Cover Set (Qty 2)
- #10 Lower Right Handlebar Assembly (Qty 1)
- #15 Right Pedal Arm Assembly (Qty 1)
- #16 Right Upper Handlebar (Qty 1)

**Hardware**

- #29 Nylon Hex Nut (Qty 2)
- #30 8x10 Set Screw (Qty 4)
- #37 8x50 Carriage Bolt (Qty 2)
- #41 4x16 Self-Tapping Round Head Screw (Qty 4)

- 9-1** Attach the Lower Right Handlebar Assembly (#10) to the Right Upper Handlebar (#16) using the two (2) Set Screws (#30).
- 9-2** Attach the Lower Right Handlebar (#10) to the Right Pedal Arm Assembly (#15) using a Nylon Hex Nut (#29), and a Carriage Bolt (#37).
- 9-3** Secure the Lower Handlebar Cover Set (#9) to the Lower Right Handlebar Assembly (#10) with two (2) Self-Tapping Round Head Screws (#41).
- 9-4** Repeat steps 9-1 through 9-3 for the Lower Left Handlebar Assembly (#6).



**Step 10—Attach the Handlebar Junction Cover Set**

**Parts**

- #5 Handlebar Junction Cover Set (Qty 2)
- #8 Left Upper Handlebar (Qty 1)
- #16 Right Upper Handlebar (Qty 1)

**Hardware**

- #11 5x8 Pan Head Screw (Qty 4)

**10-1** Attach the Handlebar Junction Cover Set (#5) to the Right Upper Handlebar (#16) with two (2) Pan Head Screws (#11) and the Cap.

**10-2** Repeat step 10-1 for the Left Upper Handlebar (#8).

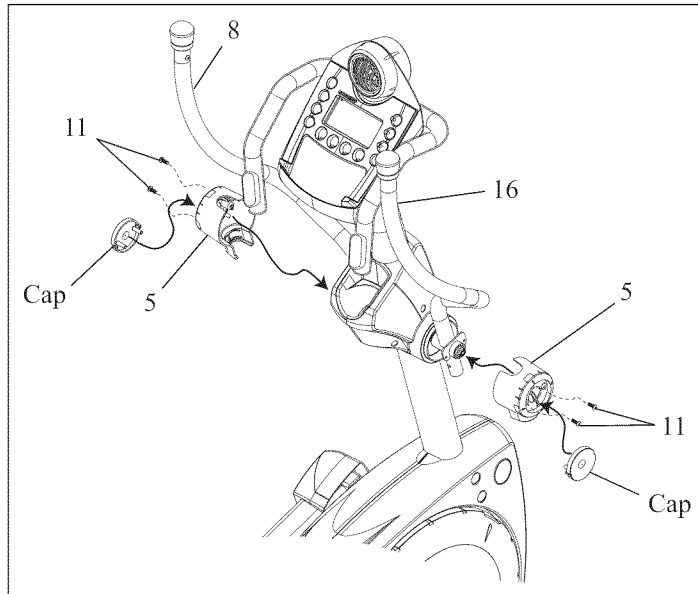

*Figure A-10*



## Important Safety Information

Do not discard this Owner's Manual. It contains important information on the proper and safe operation of your Schwinn® Elliptical Trainer Model 438.

The following is a list of warning labels used throughout this manual:

**Warning:** Indicates a potentially hazardous situation which, if not avoided, could result in death or serious injury.

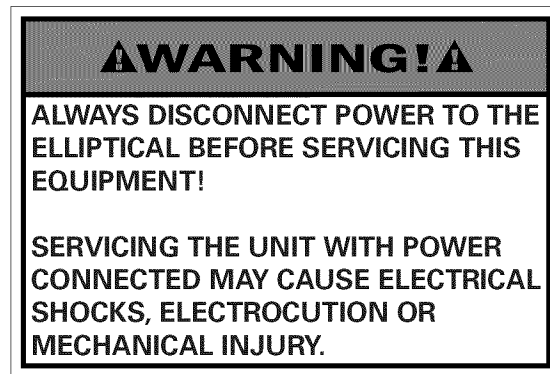

## Fitness Safeguards and Warnings

Before starting any exercise program, obtain a medical exam to confirm your fitness level and ability to perform the planned program. See your physician; he or she can help establish the correct exercise frequency, intensity (target heart rate zone), and time appropriate for your particular age and condition.

The following five warnings listed below are located on the warning label affixed to the computer console mast of the machine:

- Read and understand the "Owner's Manual" before using this equipment.
- If you feel unusual pain, dizziness, shortness of breath, chest tightness or discomfort, STOP all use, and consult your physician immediately.
- Misuse or abuse of this equipment may lead to serious injury.
- Keep children away from this equipment, and supervise teenagers using it.
- Replace this or any other warning label if damaged, illegible, or missing.

### Other Important Safeguards and Warnings

- The equipment is not designed for, and is not safe for, use by people weighing more than 300 pounds (136 kilograms).
- Follow all instructions in the *Schwinn® Elliptical Trainer Model 438 Assembly Guide and Owner's Manual*. Use the machine only as outlined in the manual's operating instructions.
- The owner must ensure that all users of this equipment are adequately informed of all warnings, precautions, and instructions.
- Keep the area within 39 inches (100 centimeters) of the equipment on all sides clear of all obstructions, children, bystanders, and pets.
- Warn bystanders to keep a safe distance from the equipment, especially from the moving pedals.
- Use the equipment only on a solid, level surface. Cover the floor or carpeting beneath the equipment for protection.
- Keep fingers and other objects away from moving parts of the equipment.
- Always wear athletic shoes for foot protection. Do not wear loose clothing that could become entangled in the drive mechanism.
- Do not allow anyone other than the user to touch the machine while it is in operation.
- Care should be taken when mounting or dismounting the machine.
- Do not operate in damp or wet conditions.
- Before each use, inspect the equipment for loose, broken, or worn parts. If any are present, do not use the equipment.
- The safety of the equipment can only be ensured if it is regularly examined and maintained. (See the maintenance section of the *Schwinn® Elliptical Trainer Model 438 Assembly Guide and Owner's Manual*.)
- Service the equipment only in accordance with the maintenance section in the *Schwinn® Elliptical Trainer Model 438 Assembly Guide and Owner's Manual*. Always disconnect the power supply before servicing the machine.
- This elliptical is for home use only. Do not use in a commercial, institutional, or rental setting.

## Schwinn® Model 438 Features

- **Synchronized Arms**  
For a total body workout.
- **Heavy Duty Construction**  
Sturdy construction stands up to the most intense workout environment.
- **Foot Platform**  
Two-piece, padded, open-ended foot plates for all sizes that move along with your natural foot motion.
- **Computer**  
Feature-packed computer with 16 levels of resistance and 24 programs. Backlit LCD with LED and scrolling alphanumeric prompts.
- **Four User Settings**  
Reprogramming not required for multiple-user households.
- **Grip and Telemetric Heart Rate**  
For monitoring your workouts.
- **3-Speed, Adjustable Air-Flow Fan**  
Keeps you cool while you workout.
- **Transport Wheels**  
Built-in transport wheels allow a single individual to easily move and position the elliptical trainer across any flat surface.
- **Frame Stabilizers**  
Oversize frame stabilizers for added stability.

## Using Your Schwinn® Elliptical Trainer Model 438

Before operating your Schwinn® 438 elliptical trainer, read the warnings listed on pages 17 and 18 of this manual.

**CONSULT YOUR PHYSICIAN BEFORE STARTING ANY EXERCISE PROGRAM.** He or she can help establish the exercise frequency, intensity, (including determining your maximum and minimum heart rate and target heart rate zones), and the exercise time appropriate for your particular age and condition.

If you have not been exercising or are pregnant or have a heart condition or any physical limitation, failure to consult your physician before engaging in physical exercise, such as using this elliptical trainer, could result in serious injury or death. If while using this elliptical trainer you have any pain or tightness in your chest, an irregular heart beat, shortness of breath, feel faint, or have any discomfort, STOP and consult your physician immediately.

### Getting Started

Plug the AC adapter into the back of the console.

To start using your Schwinn® elliptical trainer, stand on the foot pedals, with the front of your shoes close to the front edge of the foot platform. Place your hands at a comfortable position on the upper body arms. Move your highest foot forward, and follow the natural path of the machine.

Start on a level that is comfortable to familiarize yourself with the machine. Once you are comfortable, start adjusting the level to achieve the desired workout.

#### ■ Full Body/Lower Body

You can use your Schwinn® elliptical trainer for a complete body workout or lower body workout only. If you choose not to use your arms, place them on the stationary handles in front of you. Remember, the more muscles you use, the more calories you burn.

#### ■ Forward/Reverse

You can use your Schwinn® 438 elliptical trainer in the forward and reverse directions to vary the muscles you work out. This will also vary your workout, helping you to stay

motivated. To change directions, simply slow the pedals down until they stop, and switch directions.

#### ■ Resistance Control

You can change the resistance level in your Schwinn® 438 elliptical trainer at any time during your workout. Adjusting your level will allow you to increase or decrease your intensity level. Use the console to control the resistance.

### Overview of the Schwinn® 438 Elliptical Computer

Your Schwinn® 438 elliptical trainer is equipped with a versatile computer console, which includes:

- Backlit LCD
- LED and scrolling alpha-numeric prompts
- 3 speed, air-flow direction adjustable fan
- Magazine rack
- Four user settings
- Quick Start
- One manual program
- Ten profile programs
- Three heart rate control programs
- Four user settings
- Eight custom user-defined programs (two for each of the four user settings)
- Time trial program
- Fitness test
- Calorie goal
- BMI (Body Mass Index)
- Recovery mode
- Results mode
- Fitness summary
- Switchable English/metric capability
- Auto shut-off

This computer provides you with important information about your workout as well as controls the resistance levels. The following sections describe how to utilize the many functions this computer provides. Keep this manual accessible for future reference, as you will want to experiment with the various

functions while you become familiar with your Schwinn® 438 elliptical trainer.

### Computer Console Design

Before we discuss using the specific functions of the computer, let's get familiar with the display, the different features, and various buttons located on the console.

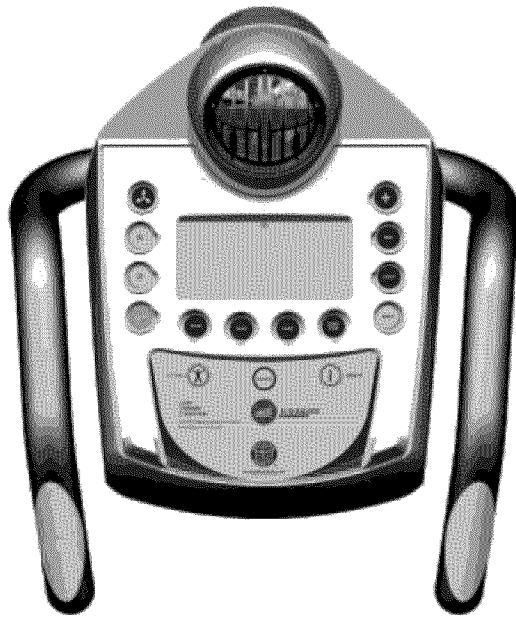

### LCD Display

The large LCD (Liquid Crystal Display) screen located in the center of the console is your information center. This display is divided into sections that provide information about your workout and any preset information you may have input into the computer.

The display provides a large main window that indicates the:

- **PROGRAM** selection and
- **RESISTANCE LEVEL.**

The smaller windows across the bottom show:

- **INTERVAL TIME** and **TIME,**

- **RPM** and **WATTS**, **DISTANCE**, and
- **HEART (PULSE) RATE**.

The next larger window on the right side of the display shows:

- **SPEED** and **CALORIES**,
- **ENGLISH** or **METRIC** operating mode, and
- the motion indicator relative to your **SPEED**.

The icon also indicates that the program is running. The large main area of the display shows the program profile you are using. Within this profile are “bricks,” or rectangles, that are stacked vertically and indicate the relative resistance level and course profile. The computer is capable of offering 16 different levels of resistance. One “brick” represents the lowest level, and eight “bricks” represent the highest level. You can view your exercise level by referencing the level numbers displayed on the left and right side of the “brick” display. Levels 1, 3, 5, 7, 9, 11, 13, and 15 display on the left side and levels 2, 4, 6, 8, 10, 12, 14, and 16 display on the right. The highest value displayed is the resistance level at which you are working out.

In addition, you will notice there are 12 columns of these “bricks” lined up horizontally across the bottom of the display center. Each profile program is 50 columns or “intervals” long, so each of these columns or “intervals” represents one-fiftieth of your workout time. For example, if you enter a workout time of 25 minutes, each column or “interval” time will last a duration of 30 seconds. Since the display shows the first 12 columns of your workout program as you progress through the workout, the program will scroll to the left. The flashing “bricks” on the left-most column let you know where you are in your workout, and other columns to the right show the upcoming course profile.

The manual, heart rate control, custom, and time trial programs will display in the 12-interval columns, as viewed on the LCD screen, and do not scroll as you advance through the workout.

#### ■ **Alphanumeric Display**

Within the LCD display the computer features a “message center” that prompts you to input specific data and values to make the elliptical trainer easy to operate and gets you to your workout quickly.

## Using the Schwinn® 438 Computer

### ■ LCD Display Descriptions

<b>TIME</b>	Displays the workout time. The time will count down from the time you entered when beginning the program and shows the time remaining for your workout. The time starts to count up once it reaches zero.
<b>INTERVAL TIME</b>	Displays the interval time. The interval time will count down, showing the time remaining before the program moves to the next column.
<b>RPM</b>	Displays the current pedal revolutions per minute (rpm).
<b>WATTS</b>	Displays the current power you are producing at a given resistance level. A watt is a measure of workload similar to horsepower (in fact, one horsepower is equal to 746 watts).
<b>DISTANCE</b>	Displays the estimated distance traveled (miles or kilometers).
<b>PULSE</b>	Displays your current heart rate beats per minute (bpm). You must grip each heart rate contact sensor pod to enable the computer to detect your heart rate.
<b>SPEED</b>	Displays the estimated speed (miles or kilometers per hour).
<b>CALORIES</b>	Displays the estimated calories you have burned during the exercise.

### ■ Console Buttons and Button Functions

<b>START/PAUSE</b>	Used to start and pause the workout. When in a program, pressing this button will pause the workout. Press this button again to restart the clock and the program where you left off.
--------------------	---

<b>UP/DOWN</b>	Used to change resistance level or to adjust values such as program time.
<b>ENTER</b>	Confirms or enters your selection.
<b>SCAN</b>	These three buttons enable the user to alternately view <b>INTERVAL TIME</b> or <b>TIME</b> , <b>RPM</b> or <b>WATTS</b> , and <b>SPEED</b> or <b>CALORIES</b> .
<b>RESET</b>	Pressing <b>RESET</b> in the Program mode will bring you back to the “ <b>ENTER PROGRAM</b> ” screen. Pressing the <b>RESET</b> button down for 2 seconds will reset the console, perform the “power-up” step, and erase all memory information.
<b>QUICK START</b>	When the screen displays “ <b>ENTER PROGRAM</b> ,” pressing this button will start the Manual program. This is a “one-touch” way of starting the Manual program.
<b>RESULTS</b>	Press <b>START/PAUSE</b> first, and then press this button to end the program and see the summary results of your workout: <b>TOTAL TIME</b> , <b>TOTAL DISTANCE</b> , <b>AVERAGE SPEED</b> , <b>AVERAGE WATTS</b> , <b>AVERAGE PULSE</b> , and <b>TOTAL CALORIES</b> . Once you press this button, your workout will end. You cannot go back and resume your workout where you left off. See <b>START/PAUSE</b> above for information regarding pausing and resuming your workout.
<b>RECOVERY</b>	Press this button to measure and obtain your heart rate recovery score. See the section “Recovery Test” on page 30.
<b>FAN</b>	The console features a fan with adjustable louvers to direct airflow to cool you off while working out. Pressing this button turns the fan on or off.

#### ■ Auto Shut-Off (Sleep Mode)

The console will automatically shut off in approximately two minutes without use or input. There is no on/off switch.

#### ■ Information Mode

The computer enables you to switch between English or metric units by pressing and holding the **UP** and **DOWN** buttons simultaneously for three seconds. Use the **UP** or **DOWN** button to select **ENGLISH** or **METRIC**, and press **ENTER** to confirm. The computer will enter the Information mode. By following the displayed menu and prompts in the Information mode, you will be able to:

Select **ENGLISH** measurement units, which sets the computer for:

- Miles
- Miles/hour
- Pounds
- Inches

Or select **METRIC** measurement units, which sets the computer for:

- Kilometers
- Kilometers/hour
- Kilograms
- Centimeters

Press **ENTER**, which will display the software version.

Press **ENTER** again to exit the Information mode, and the computer will bring you to the “**ENTER PROGRAM**” mode.

#### ■ Grip Heart Rate

This Schwinn® elliptical trainer is equipped with grip heart rate sensors located on the handlebars. You must contact these sensors with both hands so that the computer can detect your pulse. The computer uses information detected by the grip heart rate sensors for many of the software features. Make sure you are gripping the pods, and look for the flashing “heart” icon and pulse rate located on the lower right portion of the LCD display (to the left of the motion indicator), indicating that a pulse signal is being received. This is extremely important for the Heart Rate

Control and Fitness Test programs. The computer must receive a steady, consistent signal for the duration of these programs to operate correctly. If there is no display, please see “IMPORTANT Things You Should Know Before Exercising” on page 32 for more information.

## Software Features

### ■ Quick Start

This is a “one-touch” way of starting the Manual program.

### ■ Manual Mode

You manually adjust the resistance level during your workout to make the program easier or more challenging.

### ■ Ten Profile Programs

The computer offers a variety of fun and exciting profile programs to keep you motivated and on track to achieving your fitness goals:

- Profile Program 1 Ride in the Park
- Profile Program 2 Rolling Hills
- Profile Program 3 Plateau
- Profile Program 4 Speed Intervals
- Profile Program 5 Strength Intervals
- Profile Program 6 Pyramid Intervals
- Profile Program 7 Ramp Interval 1
- Profile Program 8 Ramp Interval 2
- Profile Program 9 Pikes Peak
- Profile Program 10 Cross-Training

### ■ Three Heart Rate Control (H.R.C.) Programs

These programs enable you to workout in three different heart rate zones: 60% to 70% of maximum heart rate, 70% to 80% of maximum heart rate, and 80% to 90% of maximum heart rate. The zones are calculated based upon your age and the percent of maximum heart rate you select to exercise in.

**Please note:** You must either use the chest strap or grip the heart rate sensor pods located on the handlebars in order for the computer to read your pulse and for the Heart Rate Control programs to work effectively.

60%–70% of maximum heart rate—General Fitness Zone—Fat Burning Exercise within this zone improves general fitness, begins to develop endurance, and contributes greatly to weight control and management by utilizing mostly fat calories for energy.

70%–80% of maximum heart rate—Aerobic Workout Zone—Endurance Training Exercise within this zone increases overall fitness, improves cardiovascular efficiency and endurance.

80%–90% of maximum heart rate—Anaerobic Workout Zone—Performance Training Exercise within this zone maximizes fitness and athletic performance. **Important:** We strongly recommend you consult with your physician before exercising in this zone.

#### ■ Four User Settings

Each user setting allows the you to set up and store into the computer memory your name, weight, height, age, and sex. Each user setting allows for two different workout profiles, which you can customize.

#### ■ Time Trial

This program enables you to workout against a “pacer” to determine how long it takes you to cover a preset distance. You preset the speed of the “pacer” as the baseline of your workout, and race to the end of the preset distance. At the end of the Time Trial, the computer displays the watts, distance, and speed you achieved.

#### ■ Fitness Test

The Fitness Test is one of the best ways to measure improvements in your physical fitness level. The test measures your fitness by comparing your power output (in watts) to your heart rate. In general, as you become “more fit,” you will produce more power (watts) at a given heart rate. As the test starts, the power (watts) slowly increases. This means you will work harder and, as a result, your heart rate increases. The watts continue to increase automatically until your heart rate reaches the “test zone.” This zone is individually computed to be near 75 percent of your maximum heart rate. When you reach the “test zone” the elliptical holds the watts steady for three minutes. This is to allow you to reach a steady state (where your heart rate has become basically steady). At the end of the three

minutes, the computer measures your heart rate, and the power (watts). These numbers, along with information about your age and weight, are put into a formula and produce a “**Fitness Score.**”

**Note:** The Fitness Test is an excellent way to measure changes in your own fitness level. It is not designed to be used to compare one person’s score to another person’s score. This is because the test protocol only estimates your “Maximum Heart Rate.”

#### ■ **Calorie Goal**

The Calorie Goal feature lets you select an amount of calories you would like to burn during your workout. When selecting **CALORIE GOAL**, use the **UP** or **DOWN** buttons to select the amount of calories you wish to burn from 10–990. Each increment will change the calories by ten. Confirm your selected value by pressing the **ENTER** button.

The console will prompt you to choose a profile program. Use the **UP** or **DOWN** buttons to select a profile program, and press the **ENTER** button to confirm your selection. During the program, the calorie display will count down from the number of calories you entered to zero.

#### ■ **Body Mass Index (BMI) Measurement**

BMI is a useful tool that shows the relationship between weight and height associated with body fat and health risk. The table below gives a general rating and BMI score<sup>1</sup>:

##### **BMI**

Underweight	Below 18.5
Normal	18.5–24.9
Overweight	25.0–29.9
Obesity	30.0 and above

There are limitations, however. It may overestimate body fat in athletes and others who have a muscular build. It may also underestimate body fat in older persons and others who have lost muscle mass.

1. SOURCE: Centers for Disease Control and Prevention (CDC), Atlanta, GA. The CDC is an agency of the federal Department of Health and Human Services.

When choosing the BMI program you will be prompted to enter your height and weight, and the computer will calculate and display your Body Mass Index. The console will display “**IDEAL BMI RANGE.**” The ideal or normal range is 18.5–24.9. The console will also display your ideal weight range for your height.

**CONSULT YOUR PHYSICIAN FOR MORE INFORMATION ABOUT BMI AND THE WEIGHT THAT IS APPROPRIATE FOR YOU.**

■ **Recovery Test**

Recovery Test shows how quickly your heart recovers from an exercise state to a more restful state. Improved recovery is an indicator of increasing fitness. For the console to perform the Recovery Test, two things must happen. You must press the **RECOVERY** button, and the console must be displaying your heart rate. When both of these situations occur, then the console will perform the Recovery Test.

The console will show “**01:00 STOP,**” and the time will begin to count down. Stop exercising but continue to grip the heart rate sensors. After five seconds, the display will show “**00:55 RELAX**” and continue to count down to 00:00.

For the entire minute, the console will also show your heart rate. You must grip the heart rate sensors for the duration of the test. The display will continue to show “**RELAX**” and your heart rate until the clock counts down to 00:00. The console will then calculate your recovery score.

Recovery Score = Your heart rate at 1:00 (the beginning of the test) minus your heart rate at 00:00 (the end of the test).

The display will show “**SCORE (RECOVERY SCORE).**” This will remain on the display for five seconds, then you can press **RESULTS** to view a summary of your workout and end the program, or press **START** to resume working out where you left off.

The higher the Recovery Test Score value, the quicker your heart rate is returning to a more restful state, and is an indication of improving fitness. By recording these values over time you can see the trend toward better health!

When you press the **RECOVERY** button and there is no heart rate signal or display, the console will show “**NEED**

HR,” and the **HEART RATE** icon on the display will blink. This message will show for five seconds, then the program will resume. You must see your heart rate on the display, and then you must push the **RECOVERY** button again to perform the test.

**Helpful Tip:** For a more relevant score, try to obtain a steady heart rate for three minutes before pressing the **RECOVERY** button. This will be easier to achieve and obtain for best results in the Quick Start or Manual program so that you can control level of resistance.

**Please note:** The **RECOVERY** button does not function when you are in the BMI program.

#### ■ Results Mode

When you complete a program, the Results mode will automatically display and show your basic workout statistics. Manually pressing the **RESULTS** button during your workout will also end the program and display your basic workout statistics. You cannot return to your workout after pressing the **RESULTS** button.

To have the option of either ending your workout and seeing your workout results or pausing your workout so you can return to where you left off, perform the following steps:

To **STOP** or **PAUSE** the program:

- 1 Press the **START/PAUSE** button to pause your workout. The display will show “**PRESS RESULT OR PRESS START.**”
- 2 Press the **RESULTS** button to have the computer show your workout results and end the program, or press **START/PAUSE** to resume the program where you left off.

In Results mode, the console will display:

“**GREAT JOB**”—This will hold for approximately three seconds.

“**YOUR RESULTS**”—This will hold for approximately three seconds.

The display will show the following workout results:

<b>SPEED</b>	Displays your average speed.
<b>TIME</b>	Displays your total time.

<b>DISTANCE</b>	Displays the total distance traveled.
<b>CALORIES</b>	Displays total calories burned.
<b>WATTS</b>	Displays the average watts.
<b>HEART RATE:</b>	Displays your average heart rate.

Pressing the **RESET** button will bring you back to “**ENTER PROGRAM.**” After 60 seconds, the console will automatically return to “**ENTER PROGRAM.**”

### **IMPORTANT Things You Should Know Before Exercising**

- The values calculated or measured by the computer are for exercise reference purposes only, **NOT FOR MEDICAL PURPOSES.**
- Pulse rate—The pulse rate will display after the system has detected four stable pulse signals. Pulse rate is then updated after receiving every two signals.  
  
**Please note:** If your heart rate goes above 199, the “**1**” will flash. So a heart rate of 224 will be displayed as “**124**”, and the “**1**” will be flashing.
- Pulse rate readout—While the grip heart rate feature is a quick and convenient way to check your heart rate, it is generally not as accurate as a wireless transmitter belt and is subject to occasional misreadings and interference. You may from time to time find inconsistencies with the heart rate display on your display console.

There are many external factors that can affect the heart rate display. Some factors that influence the reliability of the heart rate signal include:

- the environment where the equipment is used,
- the physiology of the users themselves, and
- Electro-Magnetic Interference (EMI) produced by such items as televisions, computers, microwave ovens, cellular and cordless telephones, and fluorescent lights.

By moving the product away from such items, you may be able to avoid many heart rate display problems.

- Resistance control—You can control the resistance of your elliptical trainer by using the **UP** or **DOWN** buttons. You increase the resistance by pressing the **UP** button or

decrease the resistance by pressing the **DOWN** button. You will notice a slight lag in time while the electronic brake adjusts to your input, so make sure to allow for this and don't over-compensate.

- **Sleep mode**—The console will enter Sleep mode, and the system will turn off automatically if there is no input for approximately two minutes. Press any button to return the computer to its pre-“sleep” state, or press and hold the **RESET** button for two seconds to clear the computer.

### Console Operation—Quick Start

#### ■ Quick Start

Press **QUICK START** to take you immediately to the Manual program. “**RESISTANCE LEVEL**” will be at level 1. Time will start from 00:00 and count up.

#### ■ Changing Levels

You can increase or decrease the resistance level by pressing the **UP** or **DOWN** buttons at any time.

#### ■ Stop or Pause the Program

Press the **START/PAUSE** button to pause your workout. The display will show “**PRESS RESULT OR PRESS START.**” If you press the **RESULTS** button, the computer will show your workout results and end the program. If you press **START/PAUSE**, the computer will resume the program where you left off.

### Console Operation—Manual Program

#### ■ Select Program

- 1 Press any button to power up the console; “**ENTER PROGRAM**” appears in the alphanumeric display.
- 2 To access the Manual program, scroll through the display using the **UP** or **DOWN** buttons until you reach “**MANUAL,**” and press **ENTER**.

#### ■ Enter Level

- 1 At the “**ENTER LEVEL**” screen, select the desired resistance level by pressing the **UP** or **DOWN** buttons to select a level from 1 to 16.

- 2 Confirm your selection by pressing **ENTER**. The default resistance level will be the last level you entered (previous workout).

#### ■ Enter Time

- 1 When the “**ENTER TIME**” screen appears, select the desired time by pressing the **UP** or **DOWN** buttons. The default time will be the last time you entered (previous workout). The minimum time you can enter is two minutes.
- 2 Confirm your selection by pressing **ENTER**.

#### ■ Enter Weight

- 1 At the “**ENTRWEIGHT...**” screen, select the appropriate weight in pounds or kilograms by pressing the **UP** or **DOWN** buttons.
- 2 Press **ENTER** to confirm your selection.

#### ■ Start

Press **START** when the “**PRESS START**” screen appears. “**MANUAL**” will display, confirming you are about to start the Manual program. You can now begin exercising.

#### ■ Changing Levels

You can increase or decrease the resistance level by pressing the **UP** or **DOWN** buttons at any time.

#### ■ Stop or Pause the Program

- 1 Press the **START/PAUSE** button to stop or pause your workout. The display will show “**PRESS RESULT OR PRESS START.**”
- 2 To stop the program, press the **RESULTS** button; the computer will show your workout results and end the program.
- 3 To pause the program, press **START/PAUSE**; the computer will resume the program where you left off.

### Console Operation—Selecting a Profile Program

#### ■ Select Program

- 1 Press any button to power up the console; “**ENTER PROGRAM**” appears in the alphanumeric display.

- 2 To access the profile programs, scroll through the display by using the **UP** or **DOWN** buttons until you reach “**PROGRAMS.**”
- 3 Press **ENTER**; the program profile and name will appear in the display.
- 4 Press the **UP** or **DOWN** buttons to select your desired program.
- 5 Press **ENTER** to confirm your selection.

#### ■ Enter Level

- 1 When the “**ENTER LEVEL**” appears on the display, scroll to the desired resistance level by pressing the **UP** or **DOWN** buttons to select a level from 1 to 16.
- 2 Confirm your selection by pressing **ENTER**. The default resistance level will be the last level you entered (previous workout).

#### ■ Enter Time

- 1 At the “**ENTER TIME**” screen, select the desired time by pressing the **UP** or **DOWN** buttons. The default time will be the last time you entered (previous workout). The minimum time you can enter is two minutes.
- 2 Press **ENTER** to confirm your selection.

#### ■ Enter Weight

- 1 At the “**ENTERWEIGHT...**” screen, select the appropriate weight in pounds or kilograms by pressing the **UP** or **DOWN** buttons.
- 2 Press **ENTER** to confirm your selection.

#### ■ Start

Press **START** when the “**PRESS START**” screen appears. The preset program you selected will display to confirm your selection. You can now begin exercising.

#### ■ Stop or Pause the Program

- 1 Press the **START/PAUSE** button to stop or pause your workout. The display will show “**PRESS RESULT OR PRESS START.**”

- 2 To stop the program, press the **RESULTS** button; the computer will show your workout results and end the program.
- 3 To pause the program, press **START/PAUSE**; the computer will resume the program where you left off.

### Console Operation—HRC (Heart Rate Control)

**Please note:** You must either use the wireless chest strap or grip the heart rate sensor pods located on the handlebars for the computer to read your pulse and for the heart rate control programs to work effectively.

Based on your age, the elliptical trainer will calculate a maximum heart rate and the heart rate zones described below. These rates are based on average fitness for persons your age. You may be more or less fit, and your actual maximum heart rate and zones may be correspondingly higher or lower. You should therefore consult your physician for the maximum heart rate that is right for you and the heart rate zones in which you can safely exercise.

#### ■ Select Program

- 1 Press any button to power up the console; “**ENTER PROGRAM**” appears in the alphanumeric display.
- 2 To access the Heart Rate Control programs, scroll through the display by pressing the **UP** or **DOWN** buttons until you reach “**HRC,**” and then press **ENTER**.

#### ■ Enter Age

- 1 When the “**ENTER AGE**” appears on the display, select your age by pressing the **UP** or **DOWN** buttons.
- 2 Confirm your selection by pressing **ENTER**.

#### ■ Enter Heart Rate Zone

- 1 At the “**ENTER HEART RATE ZONE**” screen, press the **UP** or **DOWN** buttons to scroll through the heart rate zones:
  - HRC 60–70 (Select this zone for fat burning.)  
Exercise within this zone improves general fitness, begins to develop endurance, and contributes

greatly to weight control and management by utilizing mostly fat calories for energy.

- HRC 70–80 (Select this zone for an aerobic workout.)

Exercise within this zone increases overall fitness, improves cardiovascular efficiency, and endurance.

- HRC 80–90 (Select this zone for an anaerobic workout.)

Exercise within this zone maximizes fitness and athletic performance.

**WE STRONGLY RECOMMEND YOU  
CONSULT WITH YOUR PHYSICIAN  
BEFORE EXERCISING IN THIS ZONE.**

Each zone will flash three times, followed by the heart beats per minute (bpm) associated with that zone. These will also flash three times.

- 2 Select the appropriate zone by pressing the **UP** or **DOWN** buttons.
- 3 Press **ENTER** to confirm your selection.

■ **Enter Time**

- 1 When “**ENTER TIME**” appears on the display, select the desired time by pressing the **UP** or **DOWN** buttons. The minimum time you can enter is 12 minutes.
- 2 Press **ENTER** to confirm your selection.

■ **Enter Weight**

- 1 At the “**ENTRWEIGHT...**” screen, select the appropriate weight in pounds or kilograms by pressing the **UP** or **DOWN** buttons.
- 2 Press **ENTER** to confirm your selection.

■ **Start**

Press **START** when the “**PRESS START**” screen appears; “HRC” will display, confirming your selection. You can now begin exercising.

### ■ Changing Levels

You can only increase or decrease the resistance level by pressing the **UP** or **DOWN** buttons when in the first interval column, which is the warm-up column. This enables you to set your starting warm-up level. A longer warm-up at lower resistance can burn more calories than a shorter warm-up at higher resistance. After the program exits the first interval warm-up column, the **UP** and **DOWN** buttons become inoperative, and the program automatically adjusts the resistance to bring you into your selected zone.

The program is designed to slowly bring you up to your selected heart rate workout zone, hold you within that zone by reading your heart rate, and adjust the level of resistance to keep your workout within that zone. The program then slowly brings you down into a cool-down zone at the end of the program by reducing the resistance level in the last two columns.

As a precaution, if your heart rate is above your selected heart rate zone and the resistance level is at the minimum level for 30 seconds, the message “**SLOW DOWN**” will appear in the alphanumeric display. If after one more minute your heart rate is still above your selected heart rate zone, the message “**STOP**” will display and the program will end.

### ■ Stop or Pause the Program

- 1 Press the **START/PAUSE** button to stop or pause your workout. The display will show “**PRESS RESULT OR PRESS START.**”
- 2 To stop the program, press the **RESULTS** button; the computer will show your workout results and end the program.
- 3 To pause the program, press **START/PAUSE**; the computer will resume the program where you left off.

**CONSULT YOUR PHYSICIAN FOR THE HEART RATE ZONE APPROPRIATE FOR YOU.**

## Console Operation—Custom 01 and Custom 02

### ■ Select Program

- 1 Press any button to power up the console; “**ENTER PROGRAM**” appears in the alphanumeric display.

- 2 To access the Custom 01 and Custom 02 programs, scroll through the display by pressing the **UP** or **DOWN** buttons until you reach “**CUSTOM PROGS.**”
- 3 Press **ENTER**; “**CUSTOM 01**” will flash.
- 4 Press the **UP** or **DOWN** buttons to alternate between the two programs.
- 5 Press **ENTER** to confirm your selection.

#### ■ Enter Time

- 1 When “**ENTER TIME**” appears on the display, select the desired time by pressing the **UP** or **DOWN** buttons. The default time will be the last time you entered (previous workout). The minimum time you can enter is two minutes.
- 2 Press **ENTER** to confirm your selection.

#### ■ Enter Weight

- 1 At the “**ENTRWEIGHT...**” screen, select the appropriate weight in pounds or kilograms by pressing the **UP** or **DOWN** buttons.
- 2 Press **ENTER** to confirm your selection.

#### ■ Start

Press **START** when the “**PRESS START**” screen appears. Depending on your choice when entering “**CUSTOM PROGS.**,” “**CUSTOM 01**” or “**CUSTOM 02**” will display, confirming your selection. You can now begin exercising, set up, or change your custom program.

#### ■ Set Up a Custom Program

You can set up your Custom program profile in each interval as you exercise. The flashing “bricks” indicate your position and interval location within the program.

Press the **UP** or **DOWN** buttons to select your desired resistance level as the program progresses through each interval. The console will store this profile in memory, which can then be accessed the next time you want to exercise within this Custom program.

### ■ Change an Existing Program

Press the **UP** or **DOWN** buttons as you exercise in each interval to override your old custom program. The console will automatically store this new profile in memory and will then be the new default Custom program.

### ■ Stop or Pause the Program

- 1 Press the **START/PAUSE** button to stop or pause your workout. The display will show “**PRESS RESULT OR PRESS START.**”
- 2 To stop the program, press the **RESULTS** button; the computer will show your workout results and end the program.
- 3 To pause the program, press **START/PAUSE**; the computer will resume the program where you left off.

## Console Operation—T. T. Program (Time Trial)

### ■ Select Program

- 1 Press any button to power up the console; “**ENTER PROGRAM**” appears in the alphanumeric display.
- 2 To access the Time Trial program, scroll through the display by pressing the **UP** or **DOWN** buttons until you reach “**T.T.PROGRAM,**” and then press **ENTER**.

### ■ Enter Distance

- 1 When “**ENTER DIST**” appears on screen, select the desired distance by pressing the **UP** or **DOWN** buttons.
- 2 Press **ENTER** to confirm your selection. You can select the desired distance in one-tenth-of-a-mile or kilometer increments.

### ■ Enter Pacer Speed

- 1 At the “**PACER SPEED**” screen, select the desired pacer speed by pressing the **UP** or **DOWN** buttons. You can select the desired pacer speed in one-tenth-of-a-mile or kilometer increments.
- 2 Press **ENTER** to confirm your selection.

### ■ Enter Weight

- 1 At the “**ENTRWEIGHT...**” screen, select the appropriate weight in pounds or kilograms by pressing the **UP** or **DOWN** buttons.
- 2 Press **ENTER** to confirm your selection.

### ■ Start

Press **START** when the “**PRESS START**” screen appears. “**T.T.PROGRAM**” will display, confirming your selection. You can now begin exercising.

The “pacer” is represented by the top flashing “brick,” and you are represented by the bottom flashing “brick.”

### ■ Change Levels

Increase or decrease the resistance level by pressing the **UP** or **DOWN** buttons at any time. Changing levels in this program is like changing gears on a bike. To increase or decrease your speed, press the **UP** or **DOWN** buttons.

### ■ End of Program

The program ends when you complete your preset distance.

### ■ Stop or Pause the Program

- 1 Press the **START/PAUSE** button to stop or pause your workout. The display will show “**PRESS RESULT OR PRESS START.**”
- 2 To stop the program, press the **RESULTS** button; the computer will show your workout results and end the program.
- 3 To pause the program, press **START/PAUSE**; the computer will resume the program where you left off.

## Console Operation—Fitness Test

**Please note:** You must either use the wireless chest strap or grip the heart rate sensor pods located on the handlebars for the computer to read your pulse and for the program to work effectively.

### ■ Select Program

- 1 Press any button to power up the console; “**ENTER PROGRAM**” appears in the alphanumeric display.

- 2 To access the Fitness Test, scroll through the display by pressing the **UP** or **DOWN** buttons until you reach “**FITNESS TEST**,” and then press **ENTER**.

#### ■ Enter Age

- 1 When the “**ENTER AGE**” screen appears, select your age by pressing the **UP** or **DOWN** buttons.
- 2 Press **ENTER** to confirm your selection.

#### ■ Enter Weight

- 1 At the “**ENTERWEIGHT...**” screen, select the appropriate weight in pounds or kilograms by pressing the **UP** or **DOWN** buttons.
- 2 Press **ENTER** to confirm your selection.

#### ■ Start

Press **START** when the “**PRESS START**” screen appears; “**FITNESS TEST**” will display, confirming your selection. You can now begin exercising.

The program begins at level 1, and it will automatically adjust to bring you into a pre-determined “test zone” based upon an estimated maximum heart rate. Once you are in the “test zone,” the resistance level will remain constant.

The time clock will begin to count down from three minutes. During the last 30 seconds, the console will record the average watts, average heart rate, and generate a “Fitness Score.” It is important to keep your rpm’s steady for the whole three minutes to maintain a steady heart rate.

The Fitness Test is an excellent way to measure changes in your own fitness level. It is not designed to be used to compare one person’s score to another person’s score. This is because the test protocol only estimates your maximum heart rate.

**Please note:** The Fitness Test is a special program that requires uninterrupted exercise. After the initial fitness test set-up, certain buttons become inoperative after starting the program test:

- **START/PAUSE**
- **RESULTS**
- **RECOVERY**

## Console Operation—Calorie Goal

The Calorie Goal program enables you to select an amount of calories you would like to burn and lets you choose a profile program to achieve that goal. Your exercise is complete when the calories count down to zero.

### ■ Select Program

- 1 Press any button to power up the console; “**ENTER PROGRAM**” appears in the alphanumeric display.
- 2 To access the Calorie Goal program, scroll through the display by pressing the **UP** or **DOWN** buttons until you reach “**CALORIE GOAL,**” and then press **ENTER**.

### ■ Enter Calories

- 1 When the “**ENTER CALS**” screen appears, select the desired calories to burn by pressing the **UP** or **DOWN** buttons.
- 2 Press **ENTER** to confirm your selection; a profile program and name will appear in the display.
- 3 Press the **UP** or **DOWN** buttons to select your desired profile program.
- 4 Press **ENTER** to confirm your selection.

### ■ Enter Level

- 1 At the “**ENTER LEVEL**” screen, select the desired resistance level from 1 to 16 by pressing the **UP** or **DOWN** buttons. The default resistance level will be the last level you entered (previous workout).
- 2 Press **ENTER** to confirm your selection.

### ■ Enter Weight

- 1 At the “**ENTRWEIGHT...**” screen, select the appropriate weight in pounds or kilograms by pressing the **UP** or **DOWN** buttons.
- 2 Press **ENTER** to confirm your selection.

### ■ Start

Press **START** when the “**PRESS START**” screen appears; “**CALORIE GOAL**” will display, confirming your selection. You can now begin exercising.

Time will begin counting up and calories will begin counting down from your preset calorie goal value until the display reaches zero. When you have reached your calorie goal, the computer displays “**GREAT JOB**,” followed by “**YOUR RESULTS**.” The display will show a summary of your workout:

- Total Time
- Total Distance
- Average Speed
- Average Watts
- Average Pulse
- Total Calories

#### ■ Change Levels

You can increase or decrease the resistance level by pressing the **UP** or **DOWN** buttons at any time.

#### ■ Stop or Pause the Program

- 1 Press the **START/PAUSE** button to stop or pause your workout. The display will show “**PRESS RESULT OR PRESS START**.”
- 2 To stop the program, press the **RESULTS** button; the computer will show your workout results and end the program.
- 3 To pause the program, press **START/PAUSE**; the computer will resume the program where you left off.

### Console Operation—Body Mass Index (BMI)

BMI is a useful tool that shows the relationship between weight and height associated with body fat and health risk.

#### ■ Select Program

- 1 Press any button to power up the console; “**ENTER PROGRAM**” appears in the alphanumeric display.
- 2 To access the BMI program, scroll through the display by pressing the **UP** or **DOWN** buttons until you reach “**BMI**,” and then press **ENTER**.

**■ Enter Weight**

- 1 At the “ENTRWEIGHT...” screen, select the appropriate weight in pounds or kilograms by pressing the **UP** or **DOWN** buttons.
- 2 Press **ENTER** to confirm your selection.

**■ Enter Height**

- 1 When the “ENTRHEIGHT” screen appears, select the appropriate height in inches or centimeters by pressing the **UP** or **DOWN** buttons.
- 2 Press **ENTER** to confirm your selection.

The computer will calculate and display your BMI. Next, ideal BMI will display: 18.5 to 24.9, followed by your ideal weight.

**Please note:** The BMI program is a special program that requires certain specific input, so certain buttons become inoperative while in the BMI program. The following buttons only work during the set-up phase of the program and become inoperative after you start the program:

- **START/PAUSE**
- **ENTER**
- **UP OR DOWN**
- **RESULTS**
- **RECOVERY**

**CONSULT YOUR PHYSICIAN FOR MORE INFORMATION ABOUT BMI AND THE WEIGHT THAT IS APPROPRIATE FOR YOU.**

**Using the Chest Strap Transmitter**

The Schwinn® 438 elliptical trainer has built-in wireless heart rate monitoring capability. When you wear the chest strap transmitter during your workout, the elliptical trainer’s computer heart rate display will continuously read out your heart rate in beats per minute. **Helpful tip:** For the most effective transmission, wet the back of the chest strap (the side that goes against your skin) before putting it on.

### Moving your Schwinn® 438 Elliptical Trainer

To move the Schwinn® 438 elliptical trainer, carefully lift the rear end of the machine. Steer the machine to the desired location. Be gentle while moving the unit as any sharp impact directly or indirectly to the computer can affect computer operation.

### Leveling your Schwinn® Elliptical Trainer

Level the elliptical trainer to compensate for uneven surfaces. To level the Schwinn® 438 elliptical trainer, raise or lower the two leveling bolts located on the underside of the rear stabilizer by screwing them in or out as needed.

### Maintaining Your Elliptical Trainer

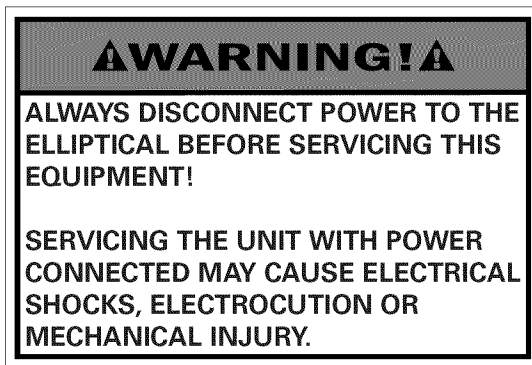

**IMPORTANT:** To avoid damaging the finish on your elliptical trainer and computer, never use a petroleum-based solvent when cleaning. Avoid getting excessive moisture on the computer.

**Daily:** Before each use, inspect for loose, broken, damaged, or worn parts. **Do not** use your elliptical trainer if found in this condition; repair or replace.

**Weekly:** Wipe any dust, dirt, or grime from the surfaces. Use a damp cloth to wipe your elliptical trainer and computer free of sweat.



**Monthly:** Check all bolts and screws and tighten as necessary.

Keep all the tools supplied with the elliptical trainer to perform future maintenance.

Call your authorized Schwinn® Fitness products distributor if you have any questions on the proper use or maintenance of this equipment, or contact Schwinn® Fitness products Customer Service at 1-800-864-1270.

## Fitness Guidelines

by Jay Blahnik

### ■ Exercise and Health

It is not a secret that lack of exercise is increasingly becoming a major health issue. Obesity is on the rise, and being overweight can contribute to an increased risk in heart attack, diabetes, high blood pressure and other life threatening illnesses.

Most people do not get enough activity during the day to make up for the time they spend at their desks, driving their cars or sitting in front of their televisions. We have learned that exercising is not simply something we must do to look good and have a great body. Exercise is a requirement for health, and overall wellness, not to mention it can help you feel great!

The good news is that we are seeing more and more research that indicates we don't have to work out intensely to see the benefits. Sure, it is great if you can workout for thirty to forty minutes at a time, five days a week. But it is not essential. Shorter bouts of exercise can have a great effect (especially if you are just starting out), and a little bit of exercise at a time is much better than none at all.

And what is really exciting is that research indicates that whether you are young or old, people who workout at light to moderate intensities may have an easier time sticking to their exercise programs than those people who work out harder and more often.

So, you do not need to be an athlete or a fitness "die-hard" to benefit from exercise... you just need to get started, work out at levels that are comfortable and enjoyable to you and stick with it!

### ■ Your New Home Fitness Program

There are many great reasons why home exercise equipment has increased in popularity over the years, but topping the list is convenience. For any fitness program to be successful, it must be something you will stick to on a regular basis. With home exercise equipment, you can roll out of bed, put on a pair of sweats and start working out while the coffee is brewing. No getting in the car and having to drive to the health club. No standing in line waiting for the equipment to become available.

And there is the comfort and safety factor. Who wants to walk or run outside when it is dark or is raining? Or try to ride a bike in the middle of heavy traffic? With your home exercise equipment, you can exercise in the comfort and security of your air-conditioned home.

Privacy and cleanliness are also important. Now you can exercise without feeling rushed or that anyone is looking at you (which is great if you are

embarrassed about carrying around a few extra pounds). No more sharing sweaty equipment, or wondering if you will catch athlete's foot in the health club shower.

The biggest advantage, however, may simply be the time factor. With work schedules ever-changing and busy family obligations, a home gym offers the benefit of being able to work out when it is most convenient for you. No classes to time your schedule around, or peak times to avoid. This is especially convenient if you have children at home.

It couldn't be easier!

## Steps To Getting Started

Once you have made the commitment to start exercising at home, here are some suggestions that may help you stay motivated.

### ■ The First Step Is the Most Difficult

Any new habit is difficult to establish at first, but it can be done. Be patient, and plan to start slow and easy. Less is more when you are first starting out ... don't overdo it!

### ■ Get a Physical Exam

If you have been inactive for several years or new to an exercise program, be sure to consult with your doctor before beginning any exercise program. Especially if you are over 30, have health problems or have a history of heart disease in your family.

### ■ Plan for Your Home Fitness Center

Set aside an area or a room in your house or apartment that is exclusively for fitness, and make sure that it is as comfortable as possible, so you'll enjoy using it. If you like music, watching television or looking outside while exercising, make sure these things are accessible. Remember, if you don't enjoy the space you are exercising in, you won't be motivated to continue your program.

### ■ Find an exercise buddy.

Research has shown that starting an exercise program with someone can increase your chances of sticking to it. If you have a buddy that is also starting a program, you can encourage, motivate and challenge each other.

### ■ Make fitness a part of your schedule.

Include it in your daily planner just as you would any other appointment. Plan ahead for the week so that you can be sure to fit it in. Even if you are pressed for time one day, a little exercise is better than none at all. Do what you can to fit it in, even if you have less time than you hoped for.

### ■ Use Positive Affirmations

Affirmations will help you program your subconscious to accept new beliefs. Saying to yourself a couple of times a day, “I am living a healthier lifestyle by exercising several times per week at home,” can help you stay on track.

### ■ Set Goals

Setting goals can be helpful in keeping you motivated, but remember to keep them realistic. Short-term and long-term goals can make this easier. How many days do you want to exercise this week? How many workouts would you like to have done in ninety days or a year?

## Components of Fitness

Over the past 25 years, many people have focused on walking, running, cycling, swimming and other types of aerobic activity as their only means of exercise.

However, we have learned that two other components of fitness are just as important. These other two components are muscle strength and flexibility. So in addition to having a strong heart and lungs, we also need to be able to pick up a full bag of groceries and tie our shoes without having to sit down.

When developing your home fitness program, it is only appropriate that you develop all three components in order to achieve balanced overall fitness. Let’s take a look at all three components:

### ■ Cardiovascular Fitness

Training the heart and lungs to be stronger and deliver more oxygen throughout your body with less effort. It can help reduce the risk of heart disease, and help you manage your weight. It is the cornerstone of fitness, and can be achieved in many ways such as walking or running on the treadmill or outdoors, climbing stairs, cycling, or using a StairMaster® stepper or swimming in the pool or ocean.

For many years, it was suggested that moderate level cardiovascular activity (activities that make you sweat and breathe and a moderate pace) should be done three to four days a week for 15–45 minutes at a time. It is now recommended that you attempt to do some cardiovascular activity EVERY day, if possible.

The good news is that the cardiovascular activity does not need to be moderately intensive everyday, nor does it need to be sustained for 15–45 minutes at a time.

So while it is ideal to challenge your heart and lungs by doing something like a strong power walk every other day for 15–45 minutes, it is more important to make sure you do at least a little bit of cardiovascular activity every day, even if you don’t do it for very long or very intensely.

For example, you might try using your Schwinn® exercise bicycle for a

scheduled, moderate level workout for 20–30 minutes on Monday, Wednesday, Friday and Sunday (see the intensity monitoring section for further details on how hard to workout). On the other days, you might try going for a leisurely stroll 10 minutes in the morning and in the evening (or whenever you can fit it in).

Whatever you do, just make sure you get your body moving, and your heart and lungs pumping for some period of time every day.

### ■ Muscular strength

Training your muscles to remain strong using resistance such as dumbbells, elastic tubing or your body weight. In the past decade, we have learned that building or maintaining muscular strength is extremely important for a balanced fitness program. And it is especially important as we get older.

We have learned through a variety of studies that those individuals who just train aerobically (without strength training) do maintain their cardiovascular endurance over the years, but they generally lose lean muscle mass as they get older. However, those individuals who combine strength training and cardiovascular training can maintain their lean body mass as they get older. What this means is that if you just do cardiovascular activity, your body will naturally lose muscle mass as you get older, and that means that you will actually get “fatter” as you age, unless you incorporate strength training.

We have also learned that consistent strength training helps maintain bone and muscle mass as we get older. For women, strength training (along with cardiovascular training) may also protect against post-menopausal bone loss and osteoporosis in their later years.

And strength training is not complicated. It is recommended that you do 8–12 repetitions of 8–10 major muscle groups at least two days a week. However, you don’t have to do all these exercises at once. You can break them up into shorter workouts throughout the day. For example, you can do just upper body exercises in the morning, and your lower body exercises in the evening. Or, you can alternate strength exercises with cardiovascular exercise (often known as circuit training) by switching back and forth every couple of minutes.

The best part is you don’t need complicated equipment or fancy machines. You can do everything you need to do with a simple pair of dumbbells, or you can try the new Nautilus® SelectTech™ dumbbells, which provide you a wide variety of weight options in a revolutionary all-in-one dumbbell. You can use elastic tubing, or simply do body weight exercises such as push-ups or lunges.

### ■ Flexibility

Being able to bend, reach, twist and turn with comfort and ease as we perform daily tasks, play or exercise. It is perhaps the most ignored component of fitness,

but certainly the easiest one to incorporate into our daily lives because it can be done anywhere and almost at any time.

To maintain your flexibility, you simply need to stretch. This could be as simple as reaching for your toes, or reaching overhead when you wake up in the morning. Or maybe you enjoy it so much that you would be interested in trying the Nautilus® yoga workout video. You can even incorporate stretching into your strength training workouts by stretching the muscles you have used immediately after you have completed your exercise set.

Like cardiovascular training, it is recommended that you stretch every day. However, you do not need to create a formalized program. You can simply make sure that you stretch your major muscle groups throughout the day. Make sure you include your thighs, calves, hamstrings, back, chest, neck and shoulders.

Do what feels good, but also remember to mix it up. Don't just do traditional "reach and hold" stretches. Also, try gently moving through a range of motion that is comfortable to you. For example, you don't have to stretch your neck simply by pulling on your head with your hand. You can also just rotate the neck slowly around and look side to side.

## Nutrition

Of course, every good health and fitness program will also include a good nutrition component. Good nutrition is likely the most important factor in maintaining ideal body weight and managing weight loss.

There are a variety of schools of thought regarding which nutrition program, diet or eating plan is best. While we do not promote or endorse any particular one, here are some things to consider that will help you get on the road to a healthy diet:

### ■ Understand Caloric Balance

How many calories you intake, and how many calories you burn off will determine whether you will gain or lose weight day to day. It is impossible to achieve weight loss without some sort of "caloric deficit" that can be obtained through cutting calories, or burning off more than you take in. The wisest approach is to do a little of both—cutting calories and exercising. It is the only proven long-term weight management program that is successful. You should ensure that you are consuming at least 1,200 calories per day total. A total weight loss of no more than two pounds per week is recommended for long-term weight management.

### ■ Eat a Variety of Foods

Regardless of your eating plan, you should be sure to include a variety of foods in your diet, maximizing your intake of fruits and vegetables whenever possible. Colorful meals and snacks that are divided amongst the four food groups will ensure that you obtain the nutrients needed for your body to function at optimal

levels. Any diet that focuses on just one food group source or processed foods can be unhealthy in the long run, and should be avoided. Don't focus too much on any particular meal or snack, but rather on your overall intake of a variety of different foods during any given day.

■ **Drink Water**

Our bodies are made up of over 70 percent water, and most of us don't drink enough. Carry water with you everywhere you go, and drink as often as you can. This helps the body function at optimum levels, and can significantly help with weight management.

■ **Eat More Often and Be Mindful of Your Portions**

Research has shown that it can be helpful to eat smaller meals more often versus three larger meals a day if you are looking to promote healthy weight maintenance or weight loss. And we have discovered that many portions we eat are much larger than necessary, and can be laden with calories. So, try snacking more and not eating so many large meals, and share your snacks or food with others (or break your portions in half) to help manage your caloric intake.

**Monitoring Your Intensity**

When you are doing cardiovascular workouts, it is important that you work at the appropriate intensities when you are first starting out. It is also important that you workout at a variety of intensities after you have built a fitness base.

Research in recent years has indicated that one of the best ways to monitor your cardiovascular intensity is to pay close attention to how you are feeling when you workout. Most individuals can do a very good job of choosing the correct intensities if they simply categorize how they feel into one of four intensity "zones."

These zones could be described the following ways:

Zone	Description
1	Easy Warm-up Cool-down
2	Challenging, but comfortable Steady endurance pace
3	Challenging, and slightly uncomfortable Race pace Borderline out of breath
4	Breathless Not maximum, but winded Can't keep the pace for very long

When you are first starting out, you should exclusively work in the Zone 1 and Zone 2 intensities. After a few weeks, you can occasionally incorporate Zone 3 and Zone 4 intensities for short periods of time. Remember, when you begin to incorporate Zone 3 and Zone 4 intensities, you will find that you will likely have to drop down to Zone 1 intensities shortly thereafter as brief recovery periods.

For variety, you can spend a little bit of time in each of the four Zones during one workout, and then spend your time in just one Zone during the next workout.

Prenatal woman should always remain at Zone 1 and Zone 2 intensities, and anyone unaware of their current medical condition should also avoid Zone 3 and Zone 4 without prior clearance from their doctor.

These Zones can be translated into target heart rate numbers if your home fitness product has a grip or telemetric heart rate counter. Research has shown the best way to do this is not to establish heart rate numbers based upon age, but rather based upon how you feel.

The following chart will allow you to log your heart rate numbers based upon how you feel when working out. Simply log the heart rate numbers you find when you feel you are working at each of the specific intensities.

A. Zone	Description	Your Heart Rate	Approximate Percentage of Maximum Heart Rate
1	Easy Warm-Up Cool-down	Insert the heart rate you get when you are working in Zone 1	50%-65%
2	Challenging, but comfortable Steady endurance pace	Insert the heart rate you get when you are working in Zone 2	65%-75%
3	Challenging and uncomfortable Race pace	Insert the heart rate you get when you are working in Zone 3	75%-85%
4	Breathless Not maximum, but winded Can't keep the pace for very long	Insert the heart rate you get when you are working in Zone 4	85%-95%

As you get in better shape, the heart rate number you obtain for each zone will get higher and higher, which means your heart is able to handle higher intensities. Or

you may find that your numbers don't change, but you are able to stay in Zone 3 and Zone 4 longer than you used to.

Don't get too attached to any specific number or target heart rate. If you train properly, you will notice numbers that used to be difficult have now become easier. You will also notice that if you are sick or over-tired, you may find that numbers that usually feel fairly easy are one day much harder, and it is a good sign to take a break. If you notice that numbers that are usually very challenging are one day fairly easy, then it is a good time to push yourself.

Listening to your body, and using your heart rate numbers (when available) will enable you to keep track of your intensity and see your progress as you train.

### **Beating the Dropout Odds**

The Surgeon General's Report on Physical Activity and Health summarizes a few main points:

1. Regular physical activity offers substantial improvements in health and well-being for a majority of Americans.
2. If you exercise regularly, you'll reduce your risk of heart attack, cancer, diabetes, high blood pressure, osteoporosis and even the common cold.
3. Regular exercise, regardless of the intensity, can help you control stress, sleep problems and depression.

The benefits of exercise and activity are AMAZING! And yet, only 22 percent of Americans engage in exercise for 20 minutes a day. And even among individuals who begin exercise programs, the dropout rate is about 50 percent.

So, how do you beat these odds? The answer appears to be in how you start and maintain your exercise program as well as how you create a habit of exercise.

Why are you starting an exercise program? For most individuals, it is to lose weight and look better, which are great reasons. However, since changes in your body shape and size can be gradual, and won't happen overnight, it is important to focus on other benefits so that you will remain motivated.

Thrive on the energy that exercise gives you. Watch your health risks scores go down. Pay attention to how much easier everyday activity is. Notice how much better you are sleeping. These kind of additional benefits will continue to keep you motivated if you make them just as important to you as weight loss.

Additionally, try not to view exercise as punishment. Look at it as an investment in your health. If you don't feel motivated to workout one day, think of something that is appealing to you that is active, and change your workout. Try not to let your workout become routine or mundane, and always remember that some exercise is better than none at all. So, if you feel you are not motivated to continue, stop your

workout early, or skip a day. It just might be the thing you need to get you excited about your next workout.

Possibly the most important thing is to keep progressing your exercise program slowly. Big increases in time or intensity can set you up for injury, and cause you to drop out. Unless you are a world-class athlete, there is no reason to workout at world-class levels. Remember to give yourself some days off and get proper rest.

Finally, try to anticipate lapses. If you are traveling, or your schedule is becoming busier, and you are fearful you may get off track, try planning ahead. For example, book a hotel that has a workout facility or change up your workout so that you keep your interest high and your boredom low. The bottom line is you must be creative and innovative to keep up your fitness program. With some imagination and planning, it is easy to do.

Exercise is one of life's joys. It energizes you, helps you look and feel better and puts you on the road to better health. Your home fitness equipment and gym is worth its weight in gold. Congratulations on making the choice to get started!

Suggested reading:

*The Complete Home Fitness Handbook* by Edmund Burke, Human Kinetics Publisher.

*Full Body Flexibility* by Jay Blahnik, Human Kinetics Publisher.

*Building Strength and Stamina* by Wayne Wescott, PhD, Human Kinetics Publisher.

*Cross-Training for Dummies* by Tony Ryan and Martica Heaner, For Dummies Publisher.



## SCHWINN® FITNESS LIMITED WARRANTY FOR EXERCISE PRODUCTS

All Schwinn® exercise products are warranted to the retail purchaser to be free from defects in materials and workmanship. Warranty coverage valid to the original purchaser only, and proof of purchase will be required. Any product sold or placed in an application not recommended by Schwinn® Fitness will void any warranty coverage set forth by Schwinn® Fitness warranty policies and procedures.

### TIME PERIOD

Residential Environment:

- 30 years on frame
- 3 years on parts
- 2 years on electronics
- 1 year on labor

This warranty excludes wear items that need to be replaced due to normal wear and tear.

### THIS WARRANTY DOES NOT COVER

- Any component on original equipment which carries a separate consumer warranty of the parts supplier.
- Normal wear and tear.
- Any damage, failure or loss caused by accident, misuse, neglect, abuse, improper assembly, improper maintenance, or failure to follow instructions or warnings in the Owner's Manual.
- Use of products in a manner or environment for which they were not designed.

### LIMITATIONS

The foregoing warranties are in lieu of and exclude all other warranties not expressly set forth herein, whether express or implied by operation of law or otherwise, including, but not limited to, warranties of merchantability or fitness for a particular purpose. Nautilus, Inc. (Nautilus) shall in no event be liable for incidental or consequential losses, damages or expenses in connection with its exercise products. Nautilus' liability hereunder is expressly limited to the replacement of goods not complying with this warranty or, at Nautilus' election, to the repayment of an amount of the purchase price of the exercise product in question. Some states do not permit the exclusion or limitation of implied warranties or incidental or consequential damages, so the preceding limitations and exclusions may not apply to you.

### PROCEDURES

Warranty service will be performed by an authorized Schwinn® Fitness Dealer. The original purchaser must provide proof of purchase. Service calls and/or transportation to and from the authorized Schwinn® Dealer is the responsibility of the purchaser.

- Nautilus will have the option to repair or replace any exercise product(s), which require warranty service.
- Nautilus will replace any equipment frame that is structurally defective with a new frame or replace the unit with a unit of equal value. Nautilus is not responsible for labor charges in replacing defective frames.
- In the event a product cannot be repaired, Nautilus will apply a limited credit reimbursement toward another Schwinn® exercise product of equal or greater value.
- Nautilus is not responsible for dealer labor charges for component changeovers completed after the labor-related warranty period(s) stated herein.
- If you elect to repair an exercise product or part yourself, using the services of someone other than an authorized Schwinn® Fitness Dealer, or use a replacement part not supplied by Nautilus, Nautilus shall not be liable for any cost, damage, failure or loss caused by the use of such unauthorized service or parts.
- See your authorized Schwinn® Fitness Dealer for service or write to:

Schwinn Fitness Technical Services, Nautilus Inc., World Headquarters, 16400 SE Nautilus Drive, Vancouver, WA 98683; or call 1-800-864-1270 for assistance or questions.



**SCHWINN FITNESS**

# Elliptical Trainer Model 438

Nautilus Inc., World Headquarters, 16400 SE Nautilus Drive, Vancouver WA 98683 © 2005 Nautilus Inc. All Rights Reserved. Nautilus and the Nautilus logo are either registered trademarks or trademarks of Nautilus Inc. Schwinn and the Schwinn Quality Seal are registered trademarks. 1.800.864.1270