

# *Owner's Guide and Installation Instructions*



***Continuous Flow  
Gas Water Heater***  
***874, 876 series***  
***612 to 620, E16 models***



*This water heater must be installed and serviced by a qualified person.  
Please leave this guide with the householder.*

**⚠ Warning:** Upon completion of the installation and commissioning of the water heater, leave this guide with the householder or a responsible officer. **DO NOT** leave this guide inside of the cover of the water heater, as it may interfere with the safe operation of the water heater or ignite when the water heater is turned on.

---

#### **PATENTS**

This water heater may be protected by one or more patents or registered designs in the name of Rheem Australia Pty Ltd or Paloma Co., Ltd.

Rheem Australia Pty Ltd is the supplier of the Rheem range of continuous flow gas water heaters, manufactured by Paloma Co., Ltd., a world leader in water heater technology and manufacture.

#### **TRADEMARKS**

® Registered trademark of Rheem Australia Pty Ltd.  
™ Trademark of Rheem Australia Pty Ltd.

**Note:** Every care has been taken to ensure accuracy in preparation of this publication. No liability can be accepted for any consequences, which may arise as a result of its application.

---

# CONTENTS

---

**HOUSEHOLDER - We recommend you read pages 4 to 44.**  
The other pages are intended for the installer but may be of interest.

<b>About Your Water Heater .....</b>	<b>4</b>
<b>Temperature Control .....</b>	<b>11</b>
<b>Temperature Control – Standard .....</b>	<b>12</b>
<b>Temperature Control – Deluxe .....</b>	<b>22</b>
<b>Water Supplies.....</b>	<b>41</b>
<b>Save A Service Call .....</b>	<b>42</b>
<b>Installation – Water Heater .....</b>	<b>45</b>
<b>Connections – Plumbing .....</b>	<b>58</b>
<b>Connections – Electrical.....</b>	<b>59</b>
<b>Ez-Link System Dual Installation .....</b>	<b>60</b>
<b>Installation – Controllers .....</b>	<b>65</b>
<b>Commissioning.....</b>	<b>72</b>
<b>Draining The Water Heater .....</b>	<b>82</b>
<b>Warranty .....</b>	<b>83</b>



---

# ABOUT YOUR WATER HEATER

---

## WATER HEATER APPLICATION

This water heater is designed for use in a single family domestic dwelling for the purpose of heating potable water. Its use in an application other than this may shorten its life.

## MODEL TYPE

The Rheem® continuous flow gas water heater model you have chosen is for outdoor installation only. This model has an extended manufacturer's warranty (refer to [the Rheem warranty](#) on page 83).

The water heater has a maximum preset outlet temperature setting of:

- 874 series                      70°C
- 876 series                      48°C

## Notes:

- The 876 series water heater is marked "THIS APPLIANCE DELIVERS WATER NOT EXCEEDING 50°C IN ACCORDANCE WITH AS 3498" on the front panel. This model;
  - **must not** be installed as an in-series gas booster to a solar water heater, as water temperature greater than 50°C can be delivered from the water heater contravening its compliance to AS 3498.
- The 874 series of water heater may be installed as an in-series gas booster to a solar water heater. For information relating to the function and operation of the solar water heater, refer to the Owner's Guide and Installation Instructions supplied with the solar water heater.
- When installed as an in-series gas booster to a solar water heater, the 874 series water heater:
  - can deliver water at temperatures up to 70°C to 80°C for a Premier Loline and Loline pumped system and a Hiline thermosiphon system and possibly higher temperatures from a Premier Hiline thermosiphon system.
  - during periods of low solar energy gain, will boost the water temperature automatically to its preset outlet temperature setting.

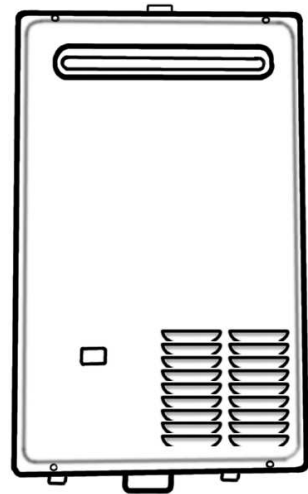

## MAINS PRESSURE

The water heater is designed for direct connection to the mains water supply. If the mains supply pressure in your area exceeds that [shown on page 48](#), a pressure limiting valve must be fitted. The supply pressure should be greater than 140 kPa for the rated flow and performance to be achieved.

## WATER HEATER OPERATION

The water heater operates automatically, heating water as it passes through the water heater. When a hot tap is opened, the gas burners ignite to provide immediate heating of the water. The heat produced by the burner is transferred to the water through the heat exchanger. The water is heated to a constant temperature by the automatic adjustment of the gas supply to the burner to suit the water flow rate (refer to "[Temperature Control](#)" on pages 11 to 40). The gas burners extinguish when the hot tap is closed.

Automatic safety controls are fitted to the water heater to provide safe and efficient operation.

## REDUCED HOT WATER FLOW WHEN HEAT EXCHANGER IS COLD

At a cold start-up, i.e. when the water heater has not operated for some time (which is most often first thing in the morning), the initial flow of hot water may be reduced for a period of 5-10 seconds while the heat exchanger warms up. **This is both an energy and water saving feature of this water heater.** Once the heat exchanger has warmed up the hot water flow will increase and remain at normal flow levels. This feature will only occur at a cold start-up and not when the heat exchanger is already warm from a recent use of hot water.

**GAS BOOSTING FOR A SOLAR WATER HEATER**

Water stored in the solar storage tank passes through the in-series gas booster when a hot tap is opened. The in-series gas booster is for heating water at times of low solar energy gain, such as during cloudy or rainy weather, or during colder months.

Solar heated water can reach temperatures up to 70°C to 80°C for a Premier Loline and Loline pumped system and a Hiline thermosiphon system and possibly higher for a Premier Hiline thermosiphon system. The in-series gas booster operates automatically. When the solar heated water temperature is 58°C or higher, the flow passes through the in-series gas booster without boosting. When the solar heated water temperature is below 58°C, the in-series gas booster heats the water to its preset outlet temperature setting.

**HOW HOT SHOULD THE WATER BE?**

The water heater may be installed with one or more user adjustable temperature controllers, which allow you to choose the most suitable temperature for your hot water needs (refer to “Temperature Control” on page 11).

If a controller is not installed, the water heater heats the water to the preset outlet temperature setting. The factory preset outlet temperature setting is:

- 874 series                      60°C
- 876 series                      48°C

**Note:** The preset outlet temperature setting of this water heater cannot be adjusted by the householder. The setting can only be adjusted by the installer, Rheem Service or their nearest Accredited Service Agent.

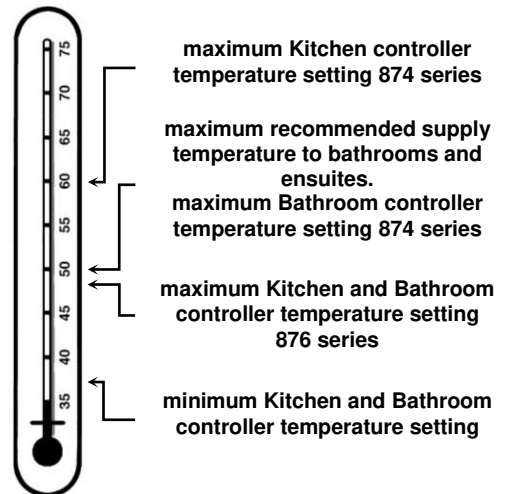

**Note:** AS 3498 requires that a water heater provides the means to inhibit the growth of Legionella bacteria in potable water. When this water heater is used as an in-series booster for a solar water heater it can satisfy this AS 3498 requirement provided it is energised, the booster preset outlet temperature setting is 70°C, and that a remote temperature controller is not used.

**⚠ Warning:** Temperature controllers **must not** be fitted to this water heater (874 series) if it is installed as an in-series gas booster with a solar water heater system because water at a temperature much higher than the controller setting can be delivered. If a solar water heater has been installed to an existing water heater installation, then all controllers **must be** disconnected and removed.

If this water heater is installed as part of a solar water heater system, the system can deliver water at temperatures from 58°C up to 80°C and possibly higher depending upon the model of solar water heater installed.

**HOTTER WATER INCREASES THE RISK OF SCALD INJURY**

This water heater can deliver water at temperatures which can cause scalding. Check the water temperature before use, such as when entering a shower or filling a bath or basin, to ensure it is suitable for the application and will not cause scald injury.

We recommend and it may be required by regulations that an approved temperature limiting device be fitted into the hot water piping to the bathroom and ensuite when an 874 series water heater is installed. This will keep the water temperature below 50°C at the bathroom and ensuite. The risk of scald injury will be reduced and if no controllers are installed or if a Kitchen controller is installed, still allow hotter water to the kitchen and laundry.

An 876 series water heater will not deliver temperatures exceeding 50°C, in accordance with AS 3498. There is no need to fit a temperature limiting device to satisfy the requirements of AS/NZS 3500.4, if an 876 series water heater is installed in an application where 50°C is the maximum permissible hot water temperature at the outlet of a sanitary fixture used primarily for personal hygiene purposes.



**⚠ WARNING**

This water heater is only intended to be operated by persons who have the experience or the knowledge and the capabilities to do so. This water heater is not intended to be operated by persons with reduced physical, sensory or mental capabilities i.e. the infirm, or by children. Children should be supervised to ensure they do not interfere with the water heater.

The water heater uses 240 Volt AC electrical power for operation of the control systems and the combustion fan. The removal of the front panel will expose 240 V wiring. It must only be removed by a qualified person.

The power lead from the water heater must be plugged into a weatherproof electrical outlet. Take care not to touch the power plug with wet hands.

**SAFETY**

This water heater is supplied with temperature sensors, a FlameSafe™ protection system and a pressure relief valve. These devices must not be tampered with or removed. The water heater must not be operated unless each of these devices is fitted and is in working order.

If the power supply cord or plug is damaged, it must be replaced by a qualified person in order to avoid a hazard. The power supply cord and plug must be replaced with a genuine replacement part available from Rheem. Phone Rheem Service or their nearest Accredited Service Agent to arrange for an inspection.

**⚠ Warning:** For continued safety of this water heater it must be installed, operated and maintained in accordance with the Owner's Guide and Installation Instructions.

**The Rheem warranty may not cover faults if relief valves or other safety devices are tampered with or if the installation is not in accordance with these instructions.**

- Do not store **flammable or combustible materials** near the water heater. Flammable liquids (such as petrol), newspapers and similar articles must be kept well away from the water heater and the flue terminal.
- Do not use **aerosols, stain removers and household chemicals** near the water heater whilst it is working. Gases from some aerosol sprays, stain removers and household chemicals become corrosive when drawn into a flame.
- Do not store **swimming pool chemicals, household cleaners**, etc., near the water heater.
- Do not place anything on top of the water heater or in contact with the flue terminal. Ensure the flue terminal is not obstructed in any way at any time.
- Do not use Propane / Butane gas mixtures in a Propane model. A Propane model is designed to operate on Propane only. The use of Propane / Butane mixture, such as automotive LPG fuel, in a Propane model is unsafe and can cause damage to the water heater.

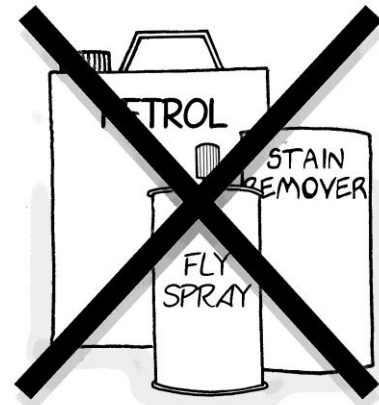

**PRECAUTIONS**

Where damage to property can occur in the event of the water heater leaking, the water heater must be installed over a safe tray. Construction, installation and draining of a safe tray must comply with AS/NZS 3500.4 and all local codes and regulatory authority requirements.

The water heater must be maintained in accordance with the Owner's Guide and Installation Instructions. Refer to [“General Maintenance”](#) on page 7, [“Minor Maintenance Every Six Months”](#) on page 7 and [“Major Service Every Five Years”](#) on page 7.

If this water heater is to be used where an uninterrupted hot water supply is necessary for your application or business you should ensure that you have back-up redundancy within the hot water system design. This should ensure the continuity of hot water supply in the event that this water heater were to become inoperable for any reason. We recommend you seek advice from your plumber or specifier about your needs and building back-up redundancy into your hot water supply system.

**GENERAL MAINTENANCE**

The jacket of the water heater can be cleaned with a soft cloth and warm mild soapy water. Under no circumstances should abrasive materials or powders be used.

The area around the water heater can be sprayed with insecticide to rid the area of insects. Insects encroaching into or nesting in the water heater can interfere with the operation of the water heater and also damage components.

**MINOR MAINTENANCE EVERY SIX MONTHS**

It is recommended minor maintenance be performed every six (6) months. Minor maintenance can be performed by the dwelling occupant.

The minor maintenance includes:

- Inspect around the air inlet, flue terminal and the water heater in general for plant growth.
  - Trim back any shrubs, bushes or other plants which have encroached around the water heater.  
Plant growth across the air inlet and flue terminal can interfere with the performance of the water heater.
- Inspect around the water heater for insect infestations, such as ants.
  - Spray insecticide around the water heater if necessary to rid the area of insects. Do not spray the surface or into the air inlet or flue terminal of the water heater.  
Insects encroaching into or nesting in the water heater can interfere with the operation of the water heater and also damage components.
- Check the drain line from the safe tray (if one is installed) is not blocked.

**MAJOR SERVICE EVERY FIVE YEARS**

For safe and efficient operation, it is recommended a major service be conducted on the water heater every five (5) years.

**⚠ Warning:** Servicing of a water heater must only be carried out by qualified personnel. Phone Rheem Service or their nearest Accredited Service Agent.

**Note:** The major service and routine replacement of any components, if required, are not included in the Rheem warranty. A charge will be made for this work. Only genuine replacement parts should be used on this water heater.

The major service includes the following actions:

- Check and if necessary adjust the gas pressure.
- Check the operation of and clean the burner.
- Check and clean the line strainer.
- Visually check the unit for any potential problems.
- Inspect all connections.
- Check the drain line from the safe tray (if one is installed) is not blocked.

### **CIRCULATED HOT WATER FLOW AND RETURN SYSTEM**

A Rheem 874 series continuous flow water heater can be installed as part of a circulated hot water flow and return system in a building. Refer to [“Circulated Hot Water Flow and Return System”](#) on page 51 for further information and notes on this type of installation.

### **GOING ON HOLIDAYS**

If you are going on holidays, it is not necessary to turn the water heater off. If it is necessary to turn off the water heater, refer to [“To Turn Off The Water Heater”](#) on page 8.

### **TO TURN OFF THE WATER HEATER**

If it is necessary to turn off the water heater:

- Turn off the controllers(s) (if fitted) by pressing the on / off (⏻) button.  
The on / off operating light will go out and the priority light, if it is on, will go out.
- Switch off the electrical supply at the power outlet to the water heater if there is no risk of freezing conditions occurring (refer to note below).
- Close the gas isolation valve at the inlet to the water heater.
- Close the cold water isolation valve at the inlet to the water heater.

**Note:** If there is a risk of freezing conditions, the electrical supply to the water heater should not be switched off unless the water heater is drained, otherwise damage could result (refer to [“Frost Protection”](#) on page 9 and [“Draining the Water Heater”](#) on page 9).

### **TO TURN ON THE WATER HEATER**

- Screw in the drain plugs at the cold water inlet and hot water outlet of the water heater if the water heater has been drained.
- Open all of the hot taps in the house (don't forget the shower).
- Open the cold water isolation valve fully at the inlet to the water heater.  
Air will be forced out of the taps.
- Close each tap as water flows freely from it.
- Open the gas isolation valve fully at the inlet to the water heater.
- Plug in the power supply cord at the power outlet.
- Switch on the electrical supply at the power outlet to the water heater.
- Turn on a controller, if one is fitted, by pressing the on / off (⏻) button.  
The on / off operating light and the priority light will both glow.

The water heater will operate automatically when you open a hot tap.

## FROST PROTECTION

The water heater has a frost protection system. The frost protection system will protect the water heater from damage, by preventing ice forming in the waterways of the water heater, in the event of freezing conditions occurring.

### Notes:

- The frost protection system will be rendered inoperable if electrical power is not available at the water heater. Damage caused by freezing due to the unavailability of power at the water heater is not covered by the Rheem warranty (refer to [“Terms of the Rheem Warranty”](#) on page 83).
- If it is necessary to switch the power off to the water heater and there is a risk of freezing, then it is necessary to drain the water heater (refer to [“Draining the Water Heater”](#) on page 9).
- Pipe work to and from the water heater must be adequately insulated to prevent freezing.
- The water heater is not suitable for installation in areas where the ambient temperature falls below -20°C (including wind chill factor).
- Refer to [“Terms of the Rheem Warranty”](#) on page 83.

## DRAINING THE WATER HEATER

- Turn off the water heater (refer to [“Turn Off The Water Heater”](#) on page 8).
- Open a hot tap (preferably the shower outlet).
- Unscrew the two drain plugs, one each at the cold water inlet and hot water outlet, on the underside of the water heater.

Water will drain from the water heater.

- When water stops flowing from the water heater, close the hot tap.

**Note:** It is recommended not to screw the drain plugs back in, until the water heater is to be turned on again.

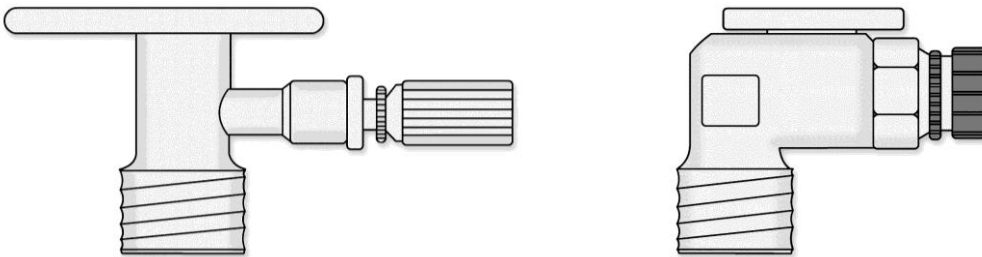

### HOW DO I KNOW IF THE WATER HEATER IS INSTALLED CORRECTLY?

Installation requirements are [shown on pages 45 to 57](#). The water heater must be installed:

- by a qualified person, and
- in accordance with the installation instructions, and
- in compliance with Standards AS/NZS 3500.4, and either AS 5601 or AS/NZS 5601.1 as applicable under local regulations, and all local codes and regulatory authority requirements.

The Gas installations Standards AS 5601 and AS/NZS 5601.1 place limitations on the location of a gas water heater within a covered area. Refer to [“Installation within a Covered Area”](#) on page 47.

**⚠ Warning:** Temperature controllers **must not** be fitted to this water heater (874 series) if it is installed as an in-series gas booster with a solar water heater system because water at a temperature much higher than the controller setting can be delivered. If a solar water heater has been installed to an existing water heater installation, then all controllers **must be** disconnected and removed.

The pipe work between the solar storage tank (if one is installed) and the in-series gas booster has a minimum recommended pipe size of DN20, **MUST BE** of copper and be fully insulated in accordance with the requirements of AS/NZS 3500.4. The insulation must be weatherproof and UV resistant if exposed. The insulation must be fitted up to the connections on both the solar storage tank and the in-series gas booster.

### VICTORIAN CUSTOMERS

Notice to Victorian Customers from the Victorian Plumbing Industry Commission. This water heater must be installed by a licensed person as required by the Victorian Building Act 1993.

Only a licensed person will give you a Compliance Certificate, showing that the work complies with all the relevant Standards. Only a licensed person will have insurance protecting their workmanship for 6 years. Make sure you use a licensed person to install this water heater and ask for your Compliance Certificate.

### DOES THE WATER CHEMISTRY AFFECT THE WATER HEATER?

The water heater is suitable for most public water supplies, however some water chemistries may have detrimental effects on the water heater, its components and fittings. Refer to [“Water Supplies”](#) on page 41.

If you are in a known harsh water area or you are not sure of your water chemistry, have your water checked against the conditions [described on page 41](#).

### HOW LONG WILL THE WATER HEATER LAST?

The water heater is supported by a manufacturer’s warranty ([refer to page 83](#)). There are a number of factors that will affect the length of service the water heater will provide. These include but are not limited to the water chemistry, the water pressure, the water temperature (inlet and outlet) and the water usage pattern. Refer to [“Precautions”](#) on page 6.

---

# TEMPERATURE CONTROL

---

## CONTROLLERS

The Rheem 874 and 876 series can be installed with Rheem controllers to enable the user to control the temperature of the delivered water from the outlet of the water heater. There are two families of Rheem controllers suitable for installation with this water heater. These are the standard controllers and the Deluxe controllers.

### Standard Controllers

There are three types of standard controller. They are the Kitchen controller (Rheem PN 299853), Bathroom1 controller (Rheem PN 299854) and the Bathroom2 controller (Rheem PN 299855). The standard controllers are suitable for use on all 874 and 876 series models.

The standard controllers are identified by a 'K' (Kitchen controller), 'B1' (Bathroom1 controller) or 'B2' (Bathroom2 controller) located on the front bottom left hand corner of the standard controller.

### Deluxe Controllers

There are three types of Deluxe controller. They are the Kitchen Deluxe controller (Rheem PN 299861), Bathroom1 Deluxe controller (Rheem PN 299862) and the Bathroom2 Deluxe controller (Rheem PN 299863). The Deluxe controllers are suitable for use on all 874 and 876 series models.

The Deluxe controllers are identified by a 'K' (Kitchen Deluxe controller), 'B1' (Bathroom1 Deluxe controller) or 'B2' (Bathroom2 Deluxe controller), located under the front panel, to the bottom left hand corner adjacent to the BATH FILL VOLUME label.

The Deluxe controllers offer additional functions to the standard controllers. These are:

- An assistance call function, which provides a voice prompt when pressed and will sound on all controllers. This is useful should a family member require assistance when in the bathroom.
- A Bath Fill function, which is designed to allow the water heater to deliver a selected volume of water at a selected temperature.

Bath filling takes place when the hot tap is opened. When the set volume has been delivered, the water flow from the water heater ceases. Refer to "[Bath-Fill Function](#)" on page 32.

**Note:** The bath level should be monitored periodically while this function is in use to avoid the possibility of the bath overflowing. The Bath Fill function should also be used with caution until you are familiar with its operation.

**⚠ Warning:** Baths should not be left unattended whenever young children are present.

**⚠ Warning:** Temperature controllers **must not** be fitted to this water heater (874 series) if it is installed as an in-series gas booster with a solar water heater system because water at a temperature much higher than the controller setting can be delivered. If a solar water heater has been installed to an existing water heater installation, then all controllers **must be** disconnected and removed.

### Notes:

- Where more than one controller is installed, the second or third controller must be of the same family.
- A standard controller can only be installed with another standard controller(s) and a Deluxe controller can only be installed with another Deluxe controller(s). A standard controller(s) and a Deluxe controller(s) cannot be connected to the same water heater.
- One, two or three controllers can be installed. Only one of each type of controller can be connected to the water heater. Therefore, a maximum of three controllers only can be connected to each water heater.
- A Bathroom2 controller can only be installed if a Bathroom1 controller is installed and a Bathroom2 Deluxe controller can only be installed if a Bathroom1 Deluxe controller is installed.
- Other manufacturers' controllers are not suitable to and cannot be installed with this water heater.

---

## TEMPERATURE CONTROL – STANDARD

---

### STANDARD CONTROLLER FUNCTIONS

If one or more controllers are installed, at least one must be on for the water heater to operate. If all controllers are off, the water heater will only deliver cold water.

**on / off** (⏻) button – This button must be pressed once to turn on the controller.

A controller cannot be turned on if water is flowing from a hot tap.

To turn off a controller, press the on / off (⏻) button once. The light will go out.

A controller can be turned off whilst water is flowing.

**on / off** operating light – The on / off operating light on the on / off (⏻) button will glow when the controller is turned on.

The light will go out when the controller is turned off.

**priority** light – This light will glow on a controller when that controller has priority.

The Bathroom controller(s), if they are turned on, have priority over the Kitchen controller.

Priority means that controller has control of the water heater temperature setting.

The water temperature setting can only be adjusted by the controller that has priority.

**in use** light – This light will glow on all controllers, whether they are on or off, when hot water is flowing, regardless of which controller has priority.

**display panel** – The current temperature setting is displayed on all controllers (whether hot water is flowing or not), when any controller is on.

If all controllers are off, then the display remains blank.

The water volume can also be displayed on the Kitchen controller. The x 10L symbol glows when the water volume is displayed.

**up** (▲) button – The up (▲) button increases the temperature and water volume settings.

Refer to [“Temperature Adjustment – Standard Controller”](#) on page 15 and [“Water Volume Function”](#) on page 20.

**down** (▼) button – The down (▼) button decreases the temperature and water volume settings.

Refer to [“Temperature Adjustment – Standard Controller”](#) on page 15 and [“Water Volume Function”](#) on page 20.

**water volume** (🚰) button (Kitchen controller only) – This feature enables an alarm to sound when a set volume of water has flowed through the water heater.

Refer to [“Water Volume Function”](#) on page 20.

**water volume** operating light – The water volume operating light on the water volume (🚰) button will glow when the water volume (🚰) button is pressed and the water volume function is turned on.

The light will go out when the water volume (🚰) button is pressed and the water volume function is turned off.

**water volume** symbol – The x 10L symbol below the display panel glows when the water volume function is turned on and the water volume is displayed.

## STANDARD CONTROLLER

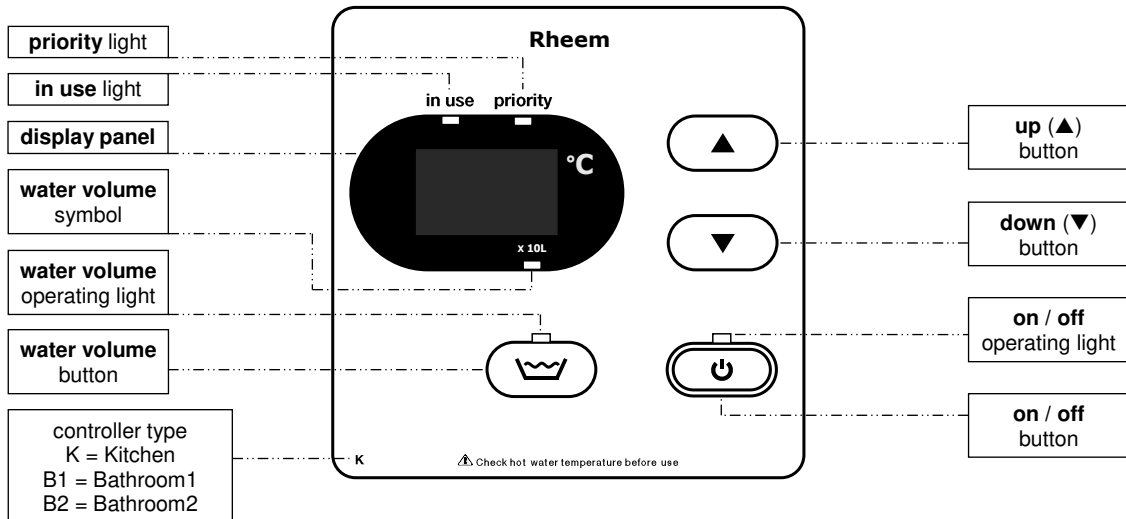

**Note:** **water volume** (👑) button, **water volume** operating light and **water volume** symbol are on the Kitchen controller only.

## SILENCING A CONTROLLER – STANDARD

The controller emits a sound whenever a button is pressed. This sound can be turned off to provide silent operation.

To turn off the sound:

- Press the on / off (🔌) button, to deactivate the controller (on / off operating light is off).
- Press and hold the up (▲) button.
- Press the on / off (🔌) button, whilst the up (▲) button is pressed.

The sound for the controller is deactivated. Repeat this procedure on the other controllers if you wish to deactivate their sound. To restore the sound, repeat this procedure.

**TEMPERATURE SETTINGS – STANDARD CONTROLLER**

The temperature settings of each type of controller are:

- Bathroom1 & 2                      37°C to 46°C (in 1°C increments), 48°C\*, 50°C
- Kitchen                                37°C to 46°C (in 1°C increments), 48°C\*, 50°C, 55°C, 60°C

\* limited to 48°C on an 876 series model.

Temperature settings

37	38	39	40	41	42	43	44	45	46	48	50	55	60
warm			average hot shower				hot			very hot			

The installation of a Bathroom controller(s) only (i.e. no Kitchen controller) limits the temperature setting of the water heater to a maximum of:

- 874 series                              50°C
- 876 series                              48°C

regardless of the preset outlet temperature setting of the water heater.

The installation of a Kitchen controller will allow a maximum temperature setting of:

- 874 series                              60°C
- 876 series                              48°C

regardless of the preset outlet temperature setting of the water heater.

If there is no controller installed, the water heater defaults to the preset outlet temperature setting. This may be up to:

- 874 series                              70°C
- 876 series                              48°C

Refer to [“How Hot Should The Water Be?”](#) on page 5.

On a building fitted with a temperature limiting device such as a tempering valve and where an 874 series water heater is installed without a separate untempered hot water line to the kitchen, laundry or other non-ablution area, although the Kitchen controller will be able to display temperatures above 50°C and the water leaving the water heater will be at the set temperature, the maximum water temperature which can be delivered to the hot water outlets in these locations is determined by the temperature setting of the temperature limiting device. This is usually 50°C.

On a building fitted with a temperature limiting device set to 50°C, to enable the delivery of water temperatures above 50°C to the kitchen, laundry or other non-ablution area, separate untempered pipe work must be installed from the water heater to the hot water outlets in these locations.



**TEMPERATURE ADJUSTMENT – STANDARD CONTROLLER**

- A controller must be on and have priority to be able to adjust the temperature setting.
- The temperature adjustment is made by pressing the up (▲) button or down (▼) button.
- The maximum temperature setting for the controllers are:

	Kitchen	Bathroom
874 series	60°C	50°C
876 series	48°C	48°C

- Each press of the up (▲) button will increase the temperature setting by one increment.
- Pressing and holding the up (▲) button will scroll the temperature setting up to a maximum 43°C if there is hot water flowing or 45°C if there is no hot water flowing.
- From the 45°C setting, the up (▲) button must be pressed once for each increase in temperature increment.
- The temperature setting cannot be increased above 43°C whilst hot water is flowing.
- The minimum temperature setting for each type of controller is 37°C.
- Each press of the down (▼) button will decrease the temperature setting by one temperature increment.
- Pressing and holding the down (▼) button will scroll down the temperature setting.
- The temperature setting can be decreased from any temperature setting whether the hot water is flowing or not.

### KITCHEN CONTROLLER – STANDARD

The Kitchen controller allows the user to select the temperature setting for the hot water to be used in the kitchen and laundry. It has a minimum temperature setting of 37°C and a maximum temperature setting of:

- 874 series 60°C
- 876 series 48°C

The Kitchen controller does not have priority if a Bathroom controller is on.

#### Notes on the Kitchen controller:

- The controller cannot be turned on whilst a hot tap is open.
- The Kitchen controller must be on and have priority in order to adjust the temperature setting on the Kitchen controller.
- The Bathroom controller(s) can be turned off from the Kitchen controller.
  - Press and hold the on / off (⏻) button on the Kitchen controller for three seconds.  
This turns off all the controllers and the displays go blank.  
If hot water is flowing from a hot tap, it will go cold.

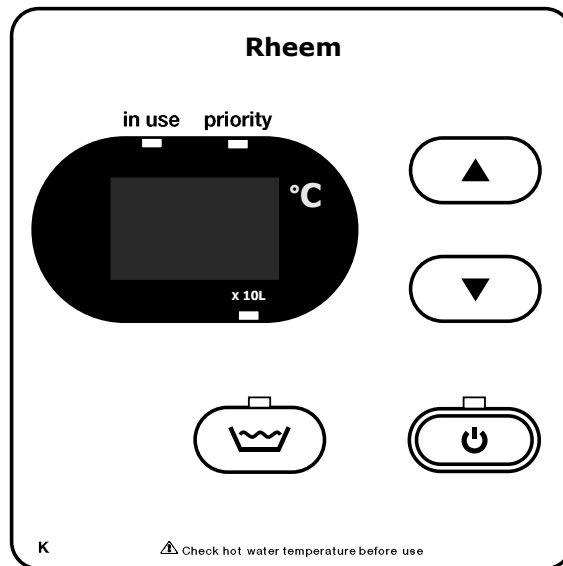

**Kitchen Controller**

To operate the Kitchen controller:

**1. Turn off the Bathroom controller(s)**

- If a temperature setting is displayed and the priority light is not glowing, it is necessary to turn off the Bathroom controller(s) to gain priority.
- Refer to the [notes on the Kitchen controller](#) on page 16.

**2. Turn on the Kitchen controller**

- Press the on / off (⏻) button.
- The on / off operating light and the priority light will both glow.
- The previous Kitchen controller temperature setting will be displayed on the temperature display panel.

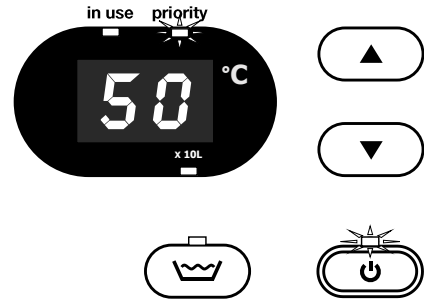

**3. Select the temperature setting**

- Press the up (▲) button or down (▼) button.
  - Refer to [“Temperature Adjustment – Standard Controller”](#) on page 15.
- The selected temperature setting will be displayed on all controllers.

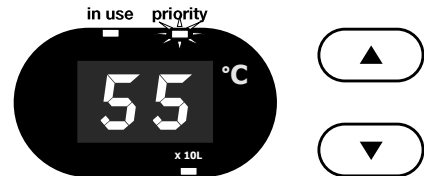

**4. Open the hot tap.**

The in use light will glow on all controllers.

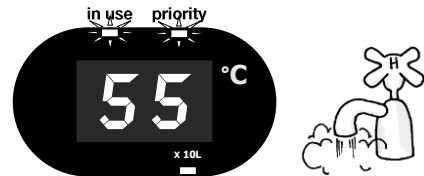

**5. Close the hot tap.**

The in use light will go out on all controllers, if no other hot tap is open.

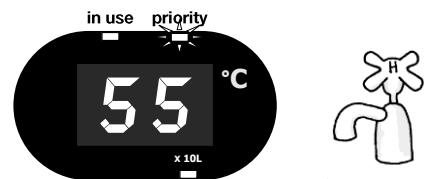

**6. Turn off the Kitchen controller**

- Press the on / off (⏻) button.
- The priority light and on / off operating light will go out and the temperature display will go blank.

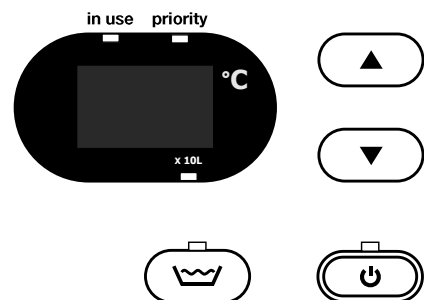

**Important:** Turn off the Kitchen controller after hot water usage is finished in the kitchen and / or laundry. Refer to [Important note for Bathroom controllers](#) on page 18.

**BATHROOM CONTROLLERS – STANDARD**

The Bathroom controller(s) allows the user to select the temperature setting for the hot water to be used in the bathroom. They have a minimum temperature setting of 37°C and a maximum temperature setting of:

- 874 series                                50°C
- 876 series                                48°C

The Bathroom controllers operate in tandem. Whenever an operation is selected on one Bathroom controller, it is also set on the other Bathroom controller. The Bathroom controllers automatically have priority if they are on.

**Important:** It is important to turn on the Bathroom controller before opening a hot tap in the bathroom (priority is automatically gained). If the Bathroom controller is not on and the Kitchen controller is on (has priority), then it is possible to receive water at a temperature higher than expected from a hot tap in the bathroom. This temperature could be up to:

- 874 series                                50°C if a temperature limiting device is installed in the hot pipe to the bathroom or up to 60°C if a temperature limiting device is not installed.
- 876 series                                48°C

**Notes on the Bathroom controllers:**

- The controller cannot be turned on whilst a hot tap is open.
- When a Bathroom controller is turned on, it gains priority from the Kitchen controller.
- The Bathroom controller must be on in order to adjust the temperature setting on the Bathroom controller.
- The Kitchen controller can be turned off from a Bathroom controller.
  - Press and hold the on / off (⏻) button on a Bathroom controller for three seconds.  
This turns off all the controllers and the displays go blank.  
If hot water is flowing from a hot tap, it will go cold.
- **⚠ Warning:** It is advised to leave the Bathroom controller on after hot water usage is finished in the bathroom. **Turning off a controller in one bathroom will also turn off the controller in the other bathroom.** The Kitchen controller will gain priority if it is on and the temperature setting can be up to:
  - 874 series                                60°C
  - 876 series                                48°C

If a hot tap is open in another bathroom, the water will be delivered at:

- For an 874 series model – up to 50°C if a temperature limiting device is installed in the hot pipe to the bathroom or up to 60°C if a temperature limiting device is not installed.
- For an 876 series model – up to 48°C.

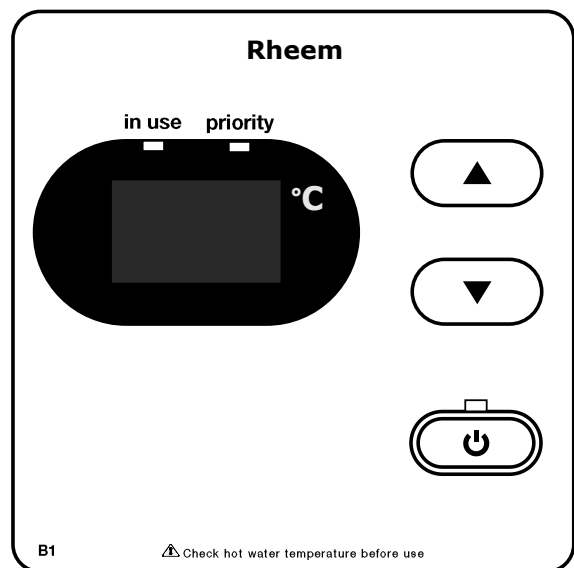

**Bathroom Controller**

To operate a Bathroom controller:

**1. Turn off the Kitchen controller**

- If a temperature setting is displayed and the priority light is not glowing, it is advised to turn off the Kitchen controller.

Refer to the [notes on the Bathroom controllers](#) on page 18.

**2. Turn on the Bathroom controller**

- Press the on / off (⏻) button.

The on / off operating light and the priority light will both glow.

The previous Bathroom controller temperature setting will be displayed on the temperature display panel.

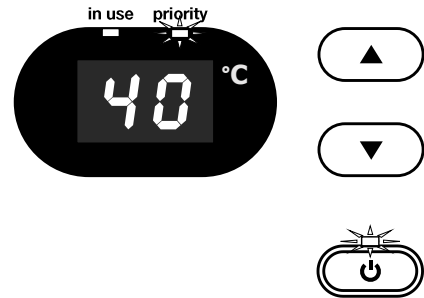

**3. Select the temperature setting**

- Press the up (▲) button or down (▼) button.
- Refer to [“Temperature Adjustment – Standard Controller”](#) on page 15.

The selected temperature setting will be displayed on all controllers.

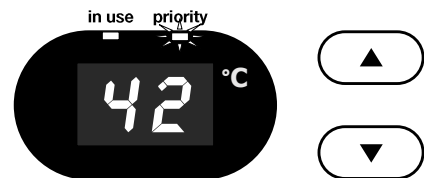

**4. Open the hot tap**

The in use light will glow on all controllers.

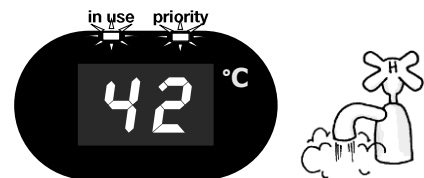

**5. Close the hot tap**

The in use light will go out on all controllers, if no other hot tap is open.

It is advised not to turn off the Bathroom controller(s).

- Refer to the [warning](#) in the notes on page 18.



## WATER VOLUME FUNCTION

The water volume function is designed to warn by an alarm (beeping sound), that a certain volume of water has been delivered from the water heater. **It does not stop either the flow of or the heating of water.** This function is useful if a bath is being filled, or measuring the water consumed by the use of a shower.

The water volume function can only be set by the Kitchen controller. Refer to the [notes on the water volume function](#) on page 21.

To operate the water volume alarm:

### 1. Turn on the water volume function

- Press the water volume () button.



The water volume operating light will glow.

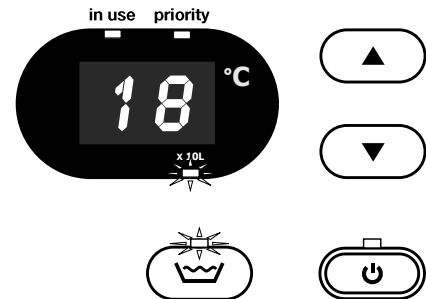

The current set water volume (in litres divided by 10) will be displayed and the x 10L indicator will also glow.



E.g. the factory preset water volume of 180 litres is shown as 18 x 10L.



### 2. Adjust the water volume setting (if necessary)

- To adjust the water volume setting, press the up () button to increase the water volume or the down () button to decrease the water volume.

Each press of the up () button or down () button will change the water volume setting by 10 litres.

Pressing the up () button or down () button continuously will scroll the water volume setting.

Fifteen seconds after the water volume has been selected, the water volume operating light will start to flash and the selected water volume is set.

The water volume operating light will continue to flash until the alarm sounds.

A maximum of 500 litres (50 and x 10L displayed) and a minimum of 10 litres (1 and x 10L displayed) can be set with the water volume function.

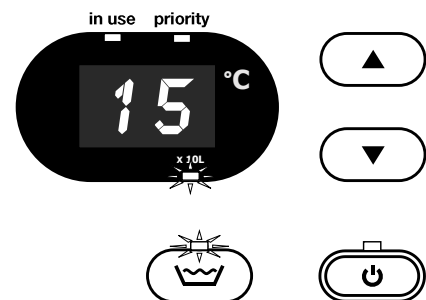

### 3. Set the water temperature

- Turn on the controller for the room where the hot water is to be used.
- Gain priority (if using the Kitchen controller).
- Select the temperature setting.

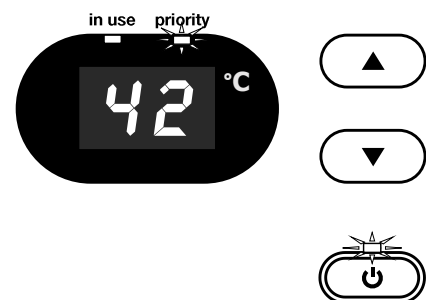

### 4. Open the hot tap

The in use light will glow on all controllers.

Measurement of the water flow at the water heater will commence when a hot tap is open and the water volume operating light is flashing.

The alarm will sound when the set volume of water has passed through the water heater.

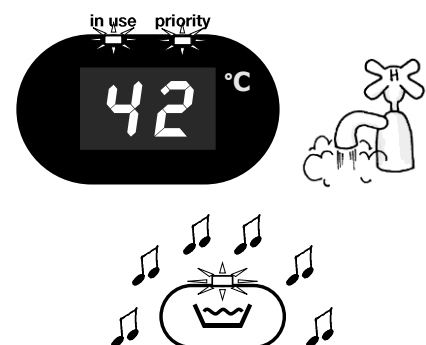

## 5. Turn off the alarm

- Press the water volume () button to turn off the alarm.

The water volume operating light goes out and 0 x 10L is displayed momentarily on the controller.

The temperature setting of the controller with priority is then displayed.

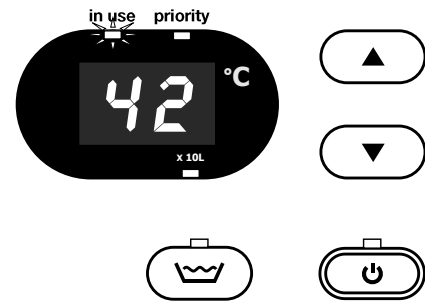

## 6. Close the hot tap

If it is a Bathroom controller which is in use and has priority, then it is advised to leave the controller on.





- Refer to the **warning** in the notes on page 18.

If it is the Kitchen controller which is in use and has priority, then it is advised to turn the controller off.

- Refer to **Important** note for Bathroom controllers on page 18.



### Notes on the water volume function:

- The water volume can only be set by the Kitchen controller.
- The Kitchen controller does not require priority nor to be on in order to set the water volume function.
- The water volume function can be set whilst a hot tap is open.
- The water volume alarm will only sound from the Kitchen controller.
- The water volume alarm will still sound if the Kitchen controller has been silenced (refer to “[Silencing A Controller](#)” on page 13).
- The factory preset water volume is 180 litres.
- If a hot tap is not opened for one hour after the new water volume has been set, then the setting will be automatically cancelled. The water volume resets to the previously set water volume (or the factory preset water volume if no water volume has previously been set).
- To display the remaining water volume while water is being drawn, press the water volume () button. After a few seconds, the display returns to the temperature setting.
- To turn off the water volume function before the alarm sounds, press the water volume () button twice.
- The water volume is measured as the water flows through the water heater. Therefore if more than one hot tap is open, the alarm will respond to the total water volume drawn from all taps and the expected water volume from the first tap will be decreased.
- If the hot tap is closed before the set water volume flows through the water heater and the water volume () button is left on, then the alarm will sound when the remaining water volume is consumed during a later operation. To prevent the alarm from sounding, press the water volume () button twice to turn it off.

---

## TEMPERATURE CONTROL – DELUXE

---

### DELUXE CONTROLLER FUNCTIONS

If one or more Deluxe controllers are installed, at least one must be on or the Bath Fill function activated for the water heater to operate. If all Deluxe controllers and the Bath Fill function are off, the water heater will only deliver cold water.

**on / off (⏻) button** – The on / off (⏻) button must be pressed once to turn on the Deluxe controller. A Deluxe controller cannot be turned on if water is flowing from a hot tap.

To turn off a Deluxe controller, press the on / off (⏻) button once. A Deluxe controller can be turned off whilst water is flowing.

**on / off operating light** – The on / off operating light on the on / off (⏻) button will glow when the Deluxe controller is turned on.

The light will go out when the Deluxe controller is turned off.

**PRIORITY light** – The PRIORITY light will glow on a Deluxe controller when the controller has priority. The Bathroom Deluxe controller(s), if they are turned on, have priority over the Kitchen Deluxe controller.

PRIORITY means that particular Deluxe controller has control of the water heater temperature setting. The water temperature setting can only be adjusted by a Deluxe controller that has priority and is displaying the PRIORITY light.

**operating light** – The operating light will glow on all Deluxe controllers, whether they are on or off, when hot water is flowing, regardless of which Deluxe controller has priority.

**temperature display panel** – The current temperature setting is displayed in °C on all Deluxe controllers (whether hot water is flowing or not), when any Deluxe controller is on. If all Deluxe controllers are off, the display remains blank.

**up (▲) button** – The up (▲) button increases the water temperature setting.

Refer to [“Temperature Adjustment – Deluxe Controllers”](#) on page 27.

**down (▼) button** – The down (▼) button decreases the water temperature setting.

Refer to [“Temperature Adjustment – Deluxe Controllers”](#) on page 27.

**assistance call (📞) button** – Pressing this button sounds an alert message on all Deluxe controllers, indicating that assistance is required in the room from which the assistance call (📞) button was activated.

**speaker** – The audio of the voice prompts and chimes is emitted from the speaker.

**bath fill (🚿) button** – The bath fill (🚿) button must be pressed once to turn on the Bath Fill function.

When the Bath Fill function is turned on, the last selected bath fill water volume in litres will be displayed in the bath fill water volume display panel and the last selected bath fill temperature in °C will be displayed in the temperature display panel.

The bath fill water volume and temperature can be adjusted by using the BATH FILL VOLUME and BATH FILL TEMPERATURE buttons located behind the hinged panel on the lower half of the Deluxe controller. Refer to [“Bath-Fill Function”](#) on page 32.

To turn off the Bath Fill function, press the bath fill (🚿) button.

**bath fill operating light** – The bath fill operating light on the bath fill (🚿) button will glow when the bath fill (🚿) button is pressed and the Bath Fill function is turned on.

The light will flash when the Bath Fill function is complete but before the Bath Fill function has been turned off.

The light will go out when the bath fill (🚿) button is pressed and the Bath Fill function is turned off.

**bath fill water volume** display panel – The selected bath fill water volume is displayed in litres on all Deluxe controllers.

The selected bath fill water volume is displayed whenever the Bath Fill function is on (refer to “Bath-Fill Function” on page 32) or when the bath fill water volume is being adjusted and the Bath Fill function is off.

If the bath fill water volume is being adjusted and the Bath Fill function is off, then the bath fill water volume display panel goes blank three (3) seconds after a BATH FILL VOLUME button is last pressed.

At other times, if the Bath Fill function is off, the bath fill water volume display panel remains blank.

**bath fill indicator light** – this light in the display panel will glow when the bath fill water volume is displayed.

**BATH FILL TEMPERATURE up (▲) button** – The up (▲) button increases the bath fill water temperature setting (refer to “Temperature Adjustment – Deluxe Controllers” on page 27 and to “Bath-Fill Function” on page 32).

**BATH FILL TEMPERATURE down (▼) button** – The down (▼) button decreases the bath fill water temperature setting (refer to “Temperature Adjustment – Deluxe Controllers” on page 27 and to “Bath-Fill Function” on page 32).

**BATH FILL VOLUME up (▲) button** – The up (▲) button increases the bath fill water volume setting in increments of 10 litres up to 500 litres. A further setting of 990 litres can be selected.

**BATH FILL VOLUME down (▼) button** – The down (▼) button decreases the bath fill water volume setting from 990 litres to 500 litres and in increments of 10 litres from 500 litres down to 10 litres.

**DELUXE CONTROLLER**

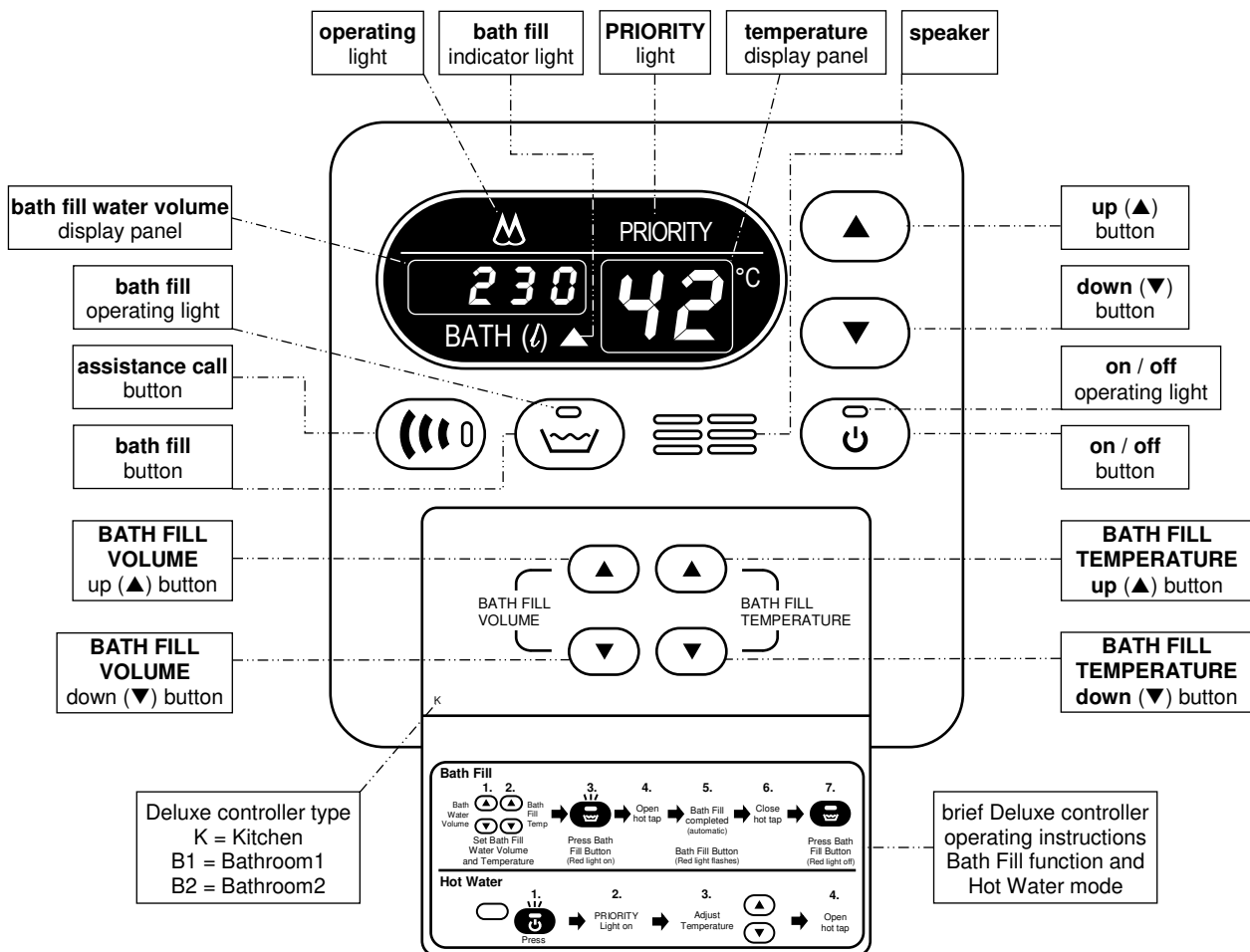

**VOICE PROMPT AND OPERATING TONE**

The Deluxe controllers have a series of voice prompts and operating tones which sound during certain operations.

The voice prompts and operating tones sound from all Deluxe controllers, regardless of which Deluxe controller is being operated at the time.

**Voice Prompt**

The voice prompts are:

- When either the up (▲) button or BATH FILL TEMPERATURE up (▲) button is pressed  
*“hot water temperature has been increased”*
- When either the down (▼) button or BATH FILL TEMPERATURE down (▼) button is pressed  
*“hot water temperature has been decreased”*
- When the BATH FILL VOLUME up (▲) button is pressed  
*“Caution, bath fill water volume has been increased, bath may overflow”*
- When the BATH FILL VOLUME down (▼) button is pressed  
*“bath fill water volume has been decreased”*
- When the bath fill (🚰) button is pressed to turn on the Bath Fill function  
*“please set bath water volume and bath temperature, then open the hot water tap”*
- When the set bath fill water volume has been delivered from the water heater during the Bath Fill function  
*“the bath is ready, please turn off the hot water tap and press the bath fill (🚰) button to finish”*
- When the bath fill (🚰) button is pressed to halt the Bath Fill function before it is complete  
*“bath filling has been stopped, please turn off the hot water tap and press the bath fill (🚰) button to finish”*
- When the bath fill (🚰) button is pressed to turn the Bath Fill function off and the hot tap has not been turned off  
*“please ensure the bath hot water tap is turned off”*
- When the Deluxe controllers have been turned off during the Bath Fill function  
*“bath filling has been stopped”*
- When the assistance call (☎) button is pressed  
*“assistance required, assistance required”*

**Operating Tone**

The operating chime will sound when the temperature adjustment up (▲) button or down (▼) button is pressed and the voice prompt is not speaking.

The operating beep will sound for each change in temperature increment when a BATH FILL TEMPERATURE adjustment button is pressed or scrolled, whether the voice prompt is speaking or not.

The operating beep will sound for each change in volume increment when a BATH FILL VOLUME adjustment button is pressed or scrolled and the voice prompt is not speaking.

### Adjusting the Volume of the Voice Prompt and Operating Tone

The volume of the voice prompt and the operating tone can be adjusted to a level comfortable for you. The volume of the voice prompt and the operating tone can be adjusted independently of each other. The volume levels on a Deluxe controller are adjusted independently of another Deluxe controller.

The voice prompt and / or operating tone can also be turned off on an individual or all Deluxe controllers so they do not sound at all.

The factory default volume setting of both the voice prompt and operating tone is medium [med]. If there is an interruption to the water heater power supply, the volume of both the voice prompt and operating tone returns to the default setting.

When adjusting the volume levels, the operating tone volume level is indicated by a chime, followed by the voice prompt volume level which is indicated by two beeps. If during the volume setting procedure only the chime is audible, this indicates the voice prompt is off. If during the volume setting procedure only the two beeps is audible, this indicates the operating tone is off.

To adjust or turn off the volume for the voice prompt and operating tone:

- Turn off all Deluxe controllers.
- Press and hold the up (▲) button, then within four (4) seconds press the on / off (⏻) button.

Each press of the on / off (⏻) button will change the voice prompt and operating tone in the following sequence:

- operating tone [MAX], voice prompt [OFF]
- operating tone [MIN], voice prompt [MIN]
- operating tone [MIN], voice prompt [OFF]
- operating tone [OFF], voice prompt [OFF]
- operating tone [MAX], voice prompt [MAX]
- operating tone [MED], voice prompt [OFF]
- operating tone [MED], voice prompt [MED]

This order then repeats.

**Note:** If the on / off (⏻) button is not pressed within four (4) seconds of the up (▲) button being pressed, “CL” will start flashing on the temperature display panel. If this occurs, release the up (▲) button and recommence the procedure.

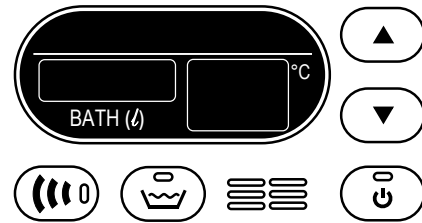

### ASSISTANCE CALL FUNCTION

A Deluxe controller has an assistance call (📞) button. Should assistance be required, such as when in the bathroom, a voice prompt will sound on all Deluxe controllers to notify others that assistance is required.

The Deluxe controller does not have to be on for the assistance call function to be activated and the function can be activated during any operation.

#### To Call for Assistance

To operate the assistance call function:

1. **Press the assistance call (📞) button.**

The voice prompt will sound on all Deluxe controllers,

*“assistance required, assistance required”*

The red light in the assistance call (📞) button will glow on all Deluxe controllers for the duration of the voice prompt.

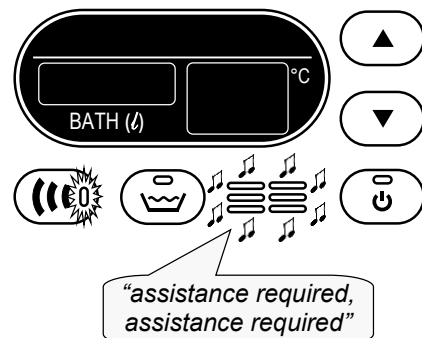

**TEMPERATURE SETTINGS – DELUXE CONTROLLERS**

The temperature settings of each type of Deluxe controller are:

- Bathroom1 & 2 Deluxe      37°C to 46°C (in 1°C increments), 48°C\*, 50°C
- Kitchen Deluxe                37°C to 46°C (in 1°C increments), 48°C\*, 50°C, 55°C, 60°C

\* limited to 48°C on an 876 series model and when the Bath Fill function is set with an 874 series model. This is to ensure the water temperature does not exceed 50°C.

Temperature settings

37	38	39	40	41	42	43	44	45	46	48	50	55	60
warm			average hot shower					hot		very hot			

The installation of a Bathroom Deluxe controller(s) only (i.e. no Kitchen Deluxe controller) limits the temperature setting of the water heater to a maximum of:

- 874 series                        50°C
- 876 series                        48°C

regardless of the preset outlet temperature setting of the water heater.

The installation of a Kitchen Deluxe controller will allow a maximum temperature setting of:

- 874 series                        60°C
- 876 series                        48°C

regardless of the preset outlet temperature setting of the water heater.

If there is no controller installed, the water heater defaults to the preset outlet temperature setting. This may be up to:

- 874 series                        70°C
- 876 series                        48°C

Refer to [“How Hot Should The Water Be?”](#) on page 5.

On a building fitted with a temperature limiting device such as a tempering valve and where an 874 series water heater is installed without a separate untempered hot water line to the kitchen, laundry or other non-ablution area, although the Kitchen Deluxe controller will be able to display temperatures above 50°C and the water leaving the water heater will be at the set temperature, the maximum water temperature which can be delivered to the hot water outlets in these locations is determined by the temperature setting of the temperature limiting device. This is usually 50°C.

On a building fitted with a temperature limiting device set to 50°C, to enable the delivery of water temperatures above 50°C to the kitchen, laundry or other non-ablution area, separate untempered pipe work must be installed from the water heater to the hot water outlets in these locations.



**TEMPERATURE ADJUSTMENT – DELUXE CONTROLLERS**

- A controller must be on with the PRIORITY indicator displayed to be able to adjust the temperature setting.
- The temperature adjustment is made by pressing the up (▲) button or down (▼) button.
- The minimum temperature setting for each type of controller is 37°C.
- The maximum temperature setting for the controllers are:

	Kitchen	Bathroom
874 series	60°C	50°C
876 series	48°C	48°C

- Each press of the up (▲) button will increase the temperature setting by one increment.
- Pressing and holding the up (▲) button will scroll the temperature setting up to a maximum 43°C if there is hot water flowing or 45°C if there is no hot water flowing.
- From the 45°C setting, the up (▲) button must be pressed once for each increase in temperature increment.
- The temperature setting cannot be increased above 43°C whilst hot water is flowing.
- Each press of the down (▼) button will decrease the temperature setting by one temperature increment.
- Pressing and holding the down (▼) button will scroll down the temperature setting.
- The temperature setting can be decreased from any temperature setting whether the hot water is flowing or not.

**Note:** A Deluxe controller sounds a double beep at the 42°C temperature setting, if the voice prompt is not speaking, when either the up (▲) button or down (▼) button has been pressed. The double beep does not sound at the 42°C temperature setting when the BATH FILL TEMPERATURE up (▲) button or BATH FILL TEMPERATURE down (▼) button is pressed.

### KITCHEN CONTROLLER – DELUXE

The Kitchen Deluxe controller allows the user to select the temperature setting for the hot water to be used in the kitchen and laundry. It has a minimum temperature setting of 37°C and a maximum temperature setting of:

- 874 series                      60°C
- 876 series                      48°C

The Kitchen Deluxe controller does not have priority (PRIORITY light is off) if a Bathroom Deluxe controller is on.

#### Notes on the Kitchen Deluxe controller:

- The Deluxe controller cannot be turned on whilst a hot tap is open.
- The Kitchen Deluxe controller must be on and have priority (PRIORITY light glows) in order to adjust the temperature setting on the Kitchen Deluxe controller.
- The Bathroom Deluxe controller(s) can be turned off from the Kitchen Deluxe controller.

Press and hold the on / off (⏻) button on the Kitchen Deluxe controller for three seconds. This turns off all the Deluxe controllers, including the Bath Fill function if it is on, the displays go blank and the lights go out. If hot water is flowing from a hot tap, it will go cold.

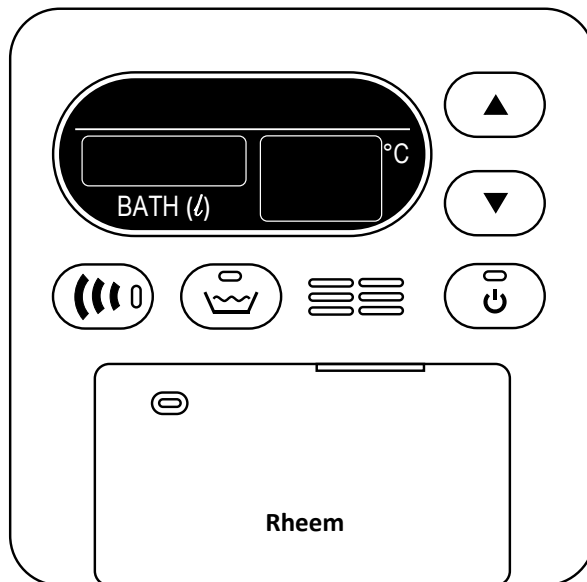

**Kitchen Deluxe Controller**

To operate the Kitchen Deluxe controller:

**1. Turn off the Bathroom Deluxe controller(s)**

- If a temperature setting is displayed and the PRIORITY light is not glowing, it is necessary to turn off the Bathroom Deluxe controller(s) to gain priority.
- Refer to the notes on the [Kitchen Deluxe controller](#) on page 28.

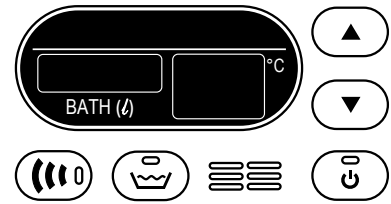

**2. Turn on the Kitchen Deluxe controller**

- Press the on / off (⏻) button.  
The on / off operating light and the PRIORITY light will both glow.  
The previous Kitchen Deluxe controller temperature setting will be displayed on the temperature display panel.

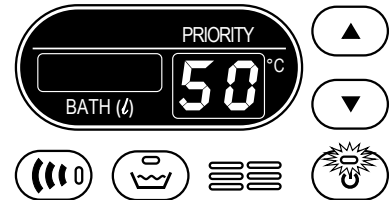

**3. Select the temperature setting**

- Press the up (▲) button or down (▼) button.  
When the up (▲) button is pressed, the voice prompt will sound;  
*“hot water temperature has been increased”*  
When the down (▼) button is pressed, the voice prompt will sound;  
*“hot water temperature has been decreased”*
- Refer to [“Temperature Adjustment – Deluxe Controllers”](#) on page 27.  
The selected temperature setting will be displayed on all Deluxe controllers.

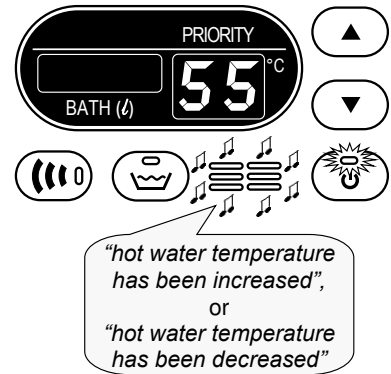

**4. Open the hot tap.**

The operating light will glow on all Deluxe controllers.

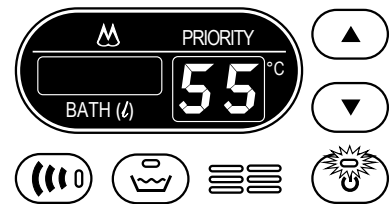

**5. Close the hot tap.**

The operating light will go out on all Deluxe controllers, if no other hot tap is open.

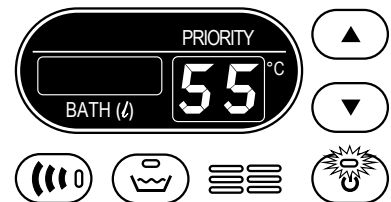

**6. Turn off the Kitchen Deluxe controller**

- Press the on / off (⏻) button.  
The PRIORITY light and the on / off operating light will go out and the temperature display panel will go blank.

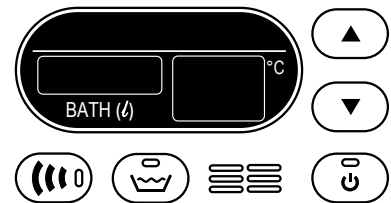

**Important:** Turn off the Kitchen Deluxe controller after hot water usage is finished in the kitchen and / or laundry. Refer to [Important](#) note for Bathroom Deluxe controllers on page 30.

**BATHROOM CONTROLLERS – DELUXE**

The Bathroom Deluxe controller(s) allows the user to select the temperature setting for the hot water to be used in the bathroom. They have a minimum temperature setting of 37°C and a maximum temperature setting of:

- 874 series                                50°C
- 876 series                                48°C

The Bathroom Deluxe controllers operate in tandem. Whenever an operation is selected on one Bathroom Deluxe controller, it is also set on the other Bathroom Deluxe controller. The Bathroom Deluxe controllers automatically have priority (PRIORITY light glows) if they are on.

**Important:** It is important to turn on the Bathroom Deluxe controller before opening a hot tap in the bathroom (priority is gained automatically and the PRIORITY light glows). If the Bathroom Deluxe controller is not on and the Kitchen Deluxe controller is on (will have priority and the PRIORITY light glows), then it is possible to receive water at a temperature higher than expected from a hot tap in the bathroom. This temperature could be up to:

- 874 series                                50°C if a temperature limiting device is installed in the hot pipe to the bathroom or up to 60°C if a temperature limiting device is not installed.
- 876 series                                48°C

**Notes on the Bathroom Deluxe controllers:**

- The Deluxe controller cannot be turned on whilst a hot tap is open.
- When a Bathroom Deluxe controller is turned on, it gains priority (PRIORITY light glows) from the Kitchen Deluxe controller.
- The Bathroom Deluxe controller must be on in order to adjust the temperature setting on the Bathroom Deluxe controller.
- The Kitchen Deluxe controller can be turned off from a Bathroom Deluxe controller.

Press and hold the on / off (⏻) button on the Bathroom Deluxe controller for three seconds. This turns off all the Deluxe controllers, including the Bath Fill function if it is on, the displays go blank and the lights go out. If hot water is flowing from a hot tap, it will go cold.

- **⚠ Warning:** It is advised to leave the Bathroom Deluxe controller on after hot water usage is finished in the bathroom. **Turning off a Bathroom Deluxe controller in one bathroom will also turn off the Bathroom Deluxe controller in the other bathroom.** The Kitchen Deluxe controller will gain priority (PRIORITY light glows) if it is on and the temperature setting can be up to:

- 874 series                                60°C
- 876 series                                48°C

If a hot tap is open in another bathroom, the water will be delivered at: for an 874 series model – up to 50°C if a temperature limiting device is installed in the hot pipe to the bathroom or up to 60°C if a temperature limiting device is not installed; or for an 876 series model – up to 48°C.

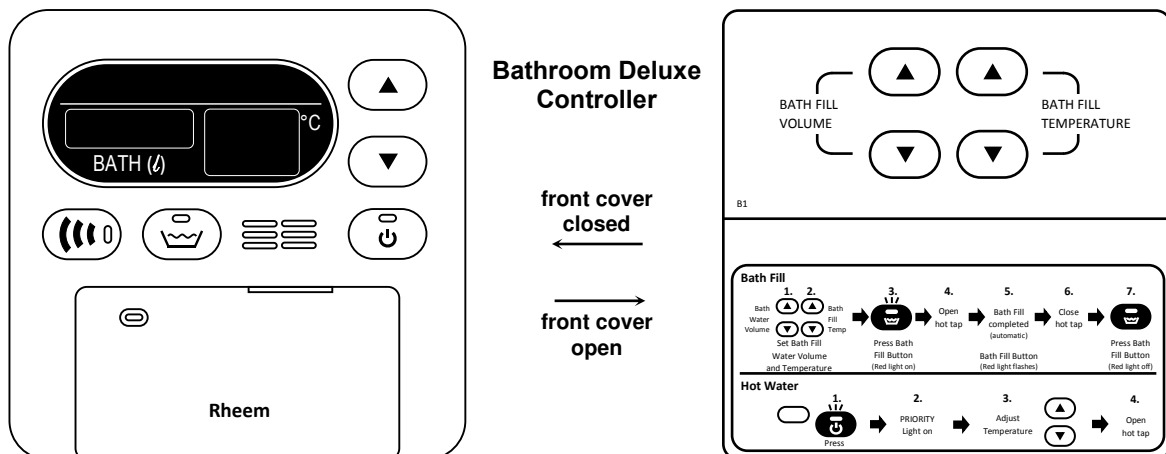

To operate a Bathroom Deluxe controller:

**1. Turn off the Kitchen Deluxe controller**

- If a temperature setting is displayed and the PRIORITY and on / off operating lights are not glowing, it is advised to turn off the Kitchen Deluxe controller.

Refer to the notes on the [Bathroom Deluxe controllers](#) on page 30.

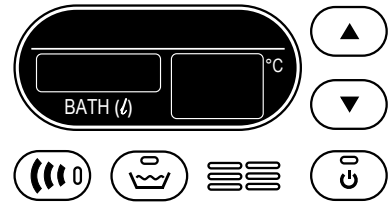

**2. Turn on the Bathroom Deluxe controller**

- Press the on / off (⏻) button.

The on / off operating light and the PRIORITY light will both glow.

The previous Bathroom Deluxe controller temperature setting will be displayed on the temperature display panel.



**3. Select the temperature setting**

- Press the up (▲) button or down (▼) button.

When the up (▲) button is pressed, the voice prompt will sound;

*“hot water temperature has been increased”*

When the down (▼) button is pressed, the voice prompt will sound;

*“hot water temperature has been decreased”*

- Refer to [“Temperature Adjustment – Deluxe Controllers”](#) on page 27.

The selected temperature setting will be displayed on all Deluxe controllers.

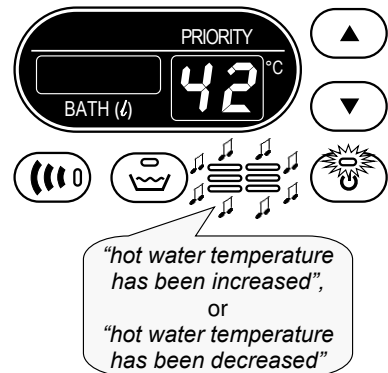

**4. Open the hot tap**

The operating light will glow on all Deluxe controllers.



**5. Close the hot tap**

The operating light will go out on all Deluxe controllers, if no other hot tap is open.

It is advised not to turn off the Bathroom Deluxe controller(s).

- Refer to the **warning** in the notes on page 30.



**BATH FILL FUNCTION**

The Bath Fill function is designed to allow the water heater to deliver a selected volume of water at a selected temperature. The Bath Fill function commences when the bath fill (👑) button is on and a hot tap is opened. When the set volume has been delivered, the water flow from the water heater ceases and heating stops. It is also useful for controlling the water volume used by a shower or other application.

**Note:** The bath level should be monitored periodically while this function is in use to avoid the possibility of the bath overflowing. The Bath Fill function should be used with caution until you are familiar with its operation.

**⚠ Warning:** Baths should not be left unattended whenever young children are present. After using the Bath Fill function, check the water temperature before entering a bath, to ensure it is suitable and will not cause scald injury.

The Bath Fill function can be set and turned off at any of the Deluxe controllers. Refer to the [notes](#) on page 38.

**Bath Fill Function – Brief Guide**

This guide provides a brief instruction on the operating sequence of the Bath Fill function. It is recommended to read the explanatory notes and become familiar with each step in the Bath Fill function. Refer to [“Bath Fill Function – Explanatory Notes”](#) on page 34.

To operate the Bath Fill function:

**1. Turn off all Deluxe controllers**

- It is advised to turn off all Deluxe controller(s) before activating the Bath Fill function.  
Refer to the notes on the [Bathroom Deluxe controllers](#) on page 30.

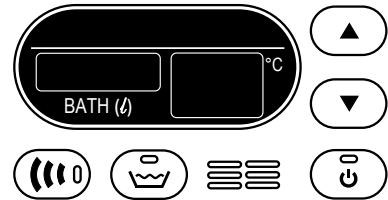

**2. Pull down the front panel on the Deluxe controller.**

The BATH FILL VOLUME and BATH FILL TEMPERATURE up (▲) and down (▼) buttons will be exposed.

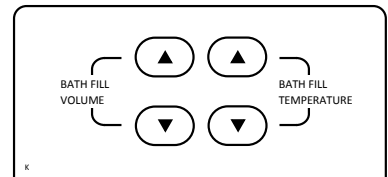

**3. Set the Bath Fill temperature**

- Press the BATH FILL TEMPERATURE up (▲) button or the BATH FILL TEMPERATURE down (▼) button to select the desired bath fill temperature.
- Refer to [“Temperature Adjustment – Deluxe Controllers”](#) on page 27.  
The selected temperature setting will be displayed on all Deluxe controllers.

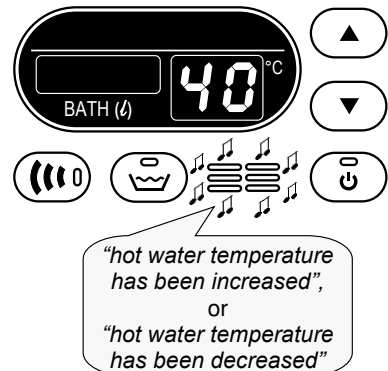

**4. Set the bath fill water volume**

- Press the BATH FILL VOLUME up (▲) button or the BATH FILL VOLUME down (▼) button to select the desired bath fill water volume. Each press will change the water volume setting by 10 litres.  
Pressing the BATH FILL VOLUME up (▲) button or BATH FILL VOLUME down (▼) button continuously will scroll the water volume setting.  
A maximum volume of 990 litres and a minimum volume of 10 litres can be set. The volume changes in 10 litre increments.  
The selected bath fill water volume will be displayed and the bath fill indicator light will glow on all Deluxe controllers.



5. Close the front panel on the Deluxe controller.

6. Turn on the Bath Fill function

- Press the bath fill (🛁) button.
- On all Deluxe controllers:
- The bath fill operating light will glow.
  - The bath fill temperature setting will appear on the temperature display panel.
  - The bath fill water volume will appear on the bath fill water volume display panel.
  - The bath fill indicator light will glow.



7. Open the hot tap.

The operating light will glow on all Deluxe controllers.  
 Measurement of the water flow at the water heater will commence when the hot tap is opened.  
 When the set volume of water has passed through the water heater:

- Water flow from the hot tap will cease.
- The operating light will go out.
- The bath fill water volume display panel will show 0 litres.
- The temperature display will go blank.
- The bath fill operating light will commence to flash
- The voice prompt will sound;

*“the bath is ready, please turn off the hot water tap and press the bath fill (🛁) button to finish”*

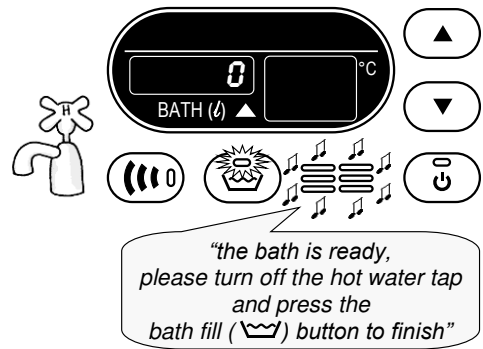

8. Close the hot tap.

9. Turn off the Bath Fill function

- Press the bath fill (🛁) button.
- The bath fill operating light and bath fill indicator light will go out.  
 The bath fill water volume display will go blank.
- Note:** If the hot tap has not been turned off, the voice prompt will sound;

*“please ensure the bath hot water tap is turned off”*

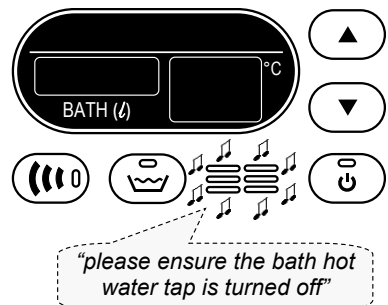

### Bath Fill Function – Explanatory Notes

To operate the Bath Fill function:

#### 1. Turn off all Deluxe controllers

- It is advised to turn off all Deluxe controller(s) before activating the Bath Fill function.

Refer to the notes on the [Bathroom Deluxe controllers](#) on page 30.

The Deluxe controllers do not need to be on to set the bath fill temperature and bath fill water volume and to turn on the Bath Fill function.

#### 2. Pull down the front panel on the Deluxe controller.

The BATH FILL VOLUME and BATH FILL TEMPERATURE up (▲) and down (▼) buttons will be exposed.

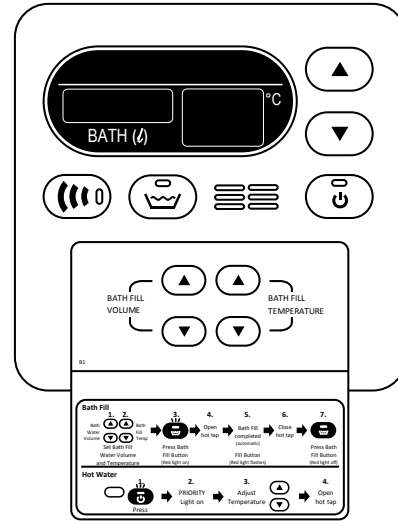

#### 3. Set the bath fill temperature

- Press the BATH FILL TEMPERATURE up (▲) button or the BATH FILL TEMPERATURE down (▼) button.

The first press of either the BATH FILL TEMPERATURE up (▲) button or the BATH FILL TEMPERATURE down (▼) button will bring up the last selected bath fill temperature setting.

While the bath fill temperature is displayed, each subsequent press of the BATH FILL TEMPERATURE up (▲) button or BATH FILL TEMPERATURE down (▼) button will change the temperature setting.

Refer to [“Temperature Adjustment – Deluxe Controllers”](#) on page 27.

When the BATH FILL TEMPERATURE up (▲) button is pressed and the temperature setting is increased, the voice prompt will sound;

*“hot water temperature has been increased”*

When the BATH FILL TEMPERATURE down (▼) button is pressed and the temperature setting is decreased, the voice prompt will sound;

*“hot water temperature has been decreased”*

The selected temperature setting will be displayed in the temperature display panel and will be displayed on all Deluxe controllers.

The temperature display panel will go blank 3 seconds after the last press of either of the bath fill temperature adjustment buttons.

The bath fill temperature setting will be remembered when the bath fill (👑) button is pressed “on”.

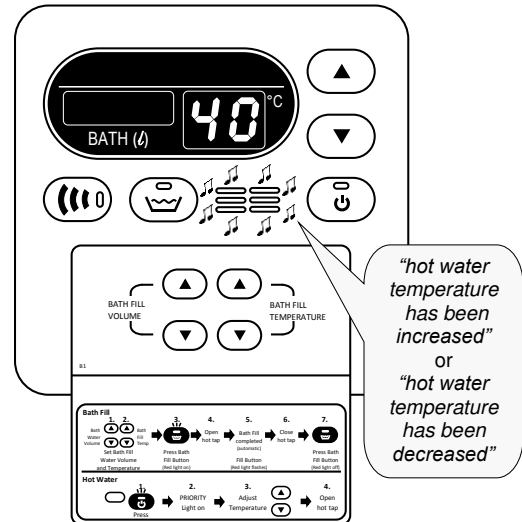

**4. Set the bath fill water volume**

- Press the BATH FILL VOLUME up (▲) button or the BATH FILL VOLUME down (▼) button.

The first press of either the BATH FILL VOLUME up (▲) button or the BATH FILL VOLUME down (▼) button will display the last selected bath fill water volume setting in the bath fill water volume display panel and the bath fill indicator light will glow.

While the bath fill water volume is displayed, each subsequent press of the BATH FILL VOLUME up (▲) button or BATH FILL VOLUME down (▼) button will change the water volume setting by 10 litres.

When the BATH FILL VOLUME up (▲) button is pressed and the water volume setting is increased, the voice prompt will sound;

*“caution, bath fill water volume has been increased, bath may overflow”*

When the BATH FILL VOLUME down (▼) button is pressed and the water volume setting is decreased, the voice prompt will sound;

*“bath fill water volume has been decreased”*

Pressing the BATH FILL VOLUME up (▲) button or BATH FILL VOLUME down (▼) button continuously will scroll the water volume setting.

A maximum volume of 990 litres and a minimum volume of 10 litres can be set. The maximum volume of 990 litres is achieved in 10 litre increments up to 500 litres, then 990 litres is the next setting.

The selected bath fill water volume will be displayed and the bath fill indicator light will glow on all Deluxe controllers.

The bath fill water volume display panel will go blank and the bath fill indicator light will go out 3 seconds after the last press of either of the volume adjustment buttons.

The set volume will be remembered when the bath fill (🛀) button is next pressed “on”.

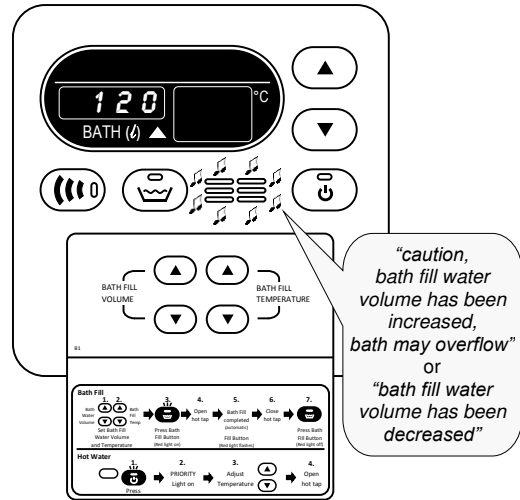

**5. Close the front panel on the Deluxe controller.**

**6. Turn on the Bath Fill function**

- Press the bath fill (🛀) button.

On all Deluxe controllers:

- The bath fill operating light will glow.
- The bath fill temperature setting will appear on the temperature display panel.
- The bath fill water volume will appear on the bath fill water volume display panel.
- The bath fill indicator light will glow.
- The voice prompt will sound;

*“please set bath water volume and bath temperature, then open the hot water tap”*

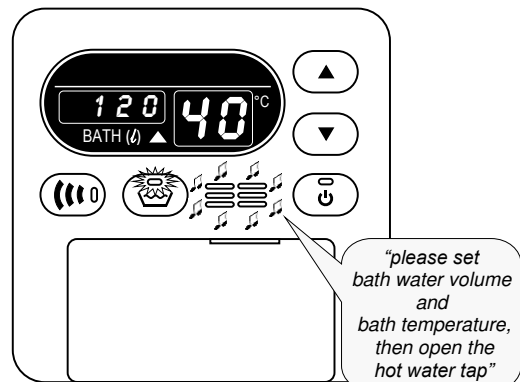
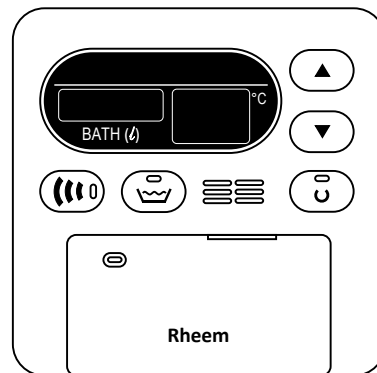

**7. Open the hot tap.**

The operating light will glow on all Deluxe controllers.

Measurement of the water flow at the water heater will commence when the hot tap is opened.

**Notes:**

- If a second hot tap is opened when the Bath Fill function is turned on, the set bath fill water volume expected from the first hot tap will be reduced by the volume which flows through the second hot tap.
- The bath fill temperature setting and bath fill water volume setting can also be adjusted whilst a hot tap is open and the Bath Fill function is operating.

When the set volume of water has passed through the water heater:

- Water flow from the hot tap will cease.
- The operating light will go out.
- The bath fill water volume display panel will show 0 litres.
- The temperature display will go blank.
- The bath fill operating light will commence to flash.
- The voice prompt will sound;

*“the bath is ready, please turn off the hot water tap and press the bath fill (🛀) button to finish”*



**8. Close the hot tap.**

**9. Turn off the Bath Fill function**

- Press the bath fill (🛀) button.

The bath fill operating light and bath fill indicator light will go out.

The bath fill water volume display will go blank.

**Note:** If the hot tap has not been turned off, the voice prompt will sound;

*“please ensure the bath hot water tap is turned off”*

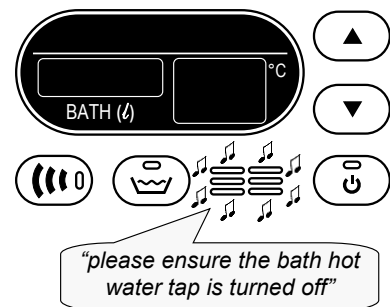
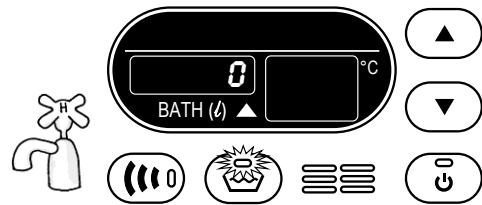

### Turning Off Bath Fill Function During Its Operation

The bath fill operation can be interrupted by pressing the bath fill (🚿) button before completion of the bath fill operation.

If it is necessary to turn off the Bath Fill function before the operation is complete, during [Step 7](#):

- Press the bath fill (🚿) button

At this first press of the bath fill (🚿) button

- Water flow from the hot tap will cease
- The operating light will go out
- The bath fill water volume display panel will show 0 litres.
- The temperature display will go blank
- The bath fill operating light will flash
- The voice prompt will sound

*“bath filling has been stopped, please turn off the hot water tap and press the bath fill (🚿) button to finish”*



- Close the hot tap

- Press the bath fill (🚿) button again

At this second press of the bath fill (🚿) button

- The bath fill operating light and bath fill indicator light will go out
- The bath fill water volume display will go blank
- Note: If the hot tap has not been turned off, the voice prompt will sound

*“please ensure the bath hot water tap is turned off”*

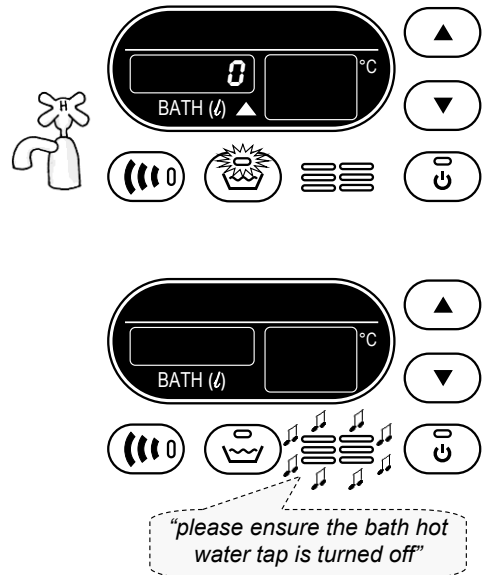

**Notes on the Bath Fill function:**

- The Bath Fill function can be set, turned on and turned off at any of the Deluxe controllers.
- The Deluxe controllers do not require to have priority (PRIORITY light glowing) or be on in order to set the bath fill water volume or bath fill temperature or to turn the bath fill (🚿) button on.
- The bath fill (🚿) button cannot be turned on whilst a hot tap is open.
- The bath fill water volume and the bath fill temperature settings can be adjusted whilst a hot tap is open.
- If a hot tap is not opened for six hours after the new bath fill water volume and bath fill temperature have been set, whilst the bath fill (🚿) button is on, the settings will be automatically cancelled and will reset to the previous settings or to the factory default settings if no previous settings have been set.
- The factory default bath fill water volume setting is 180 litres.
- The factory default bath fill temperature setting is 40°C.
- The Bath Fill function will automatically have priority when the bath fill (🚿) button is pressed and the Bath Fill function is turned on. If the PRIORITY light is glowing on a Deluxe controller, it will go out. The PRIORITY light on a Deluxe controller will not glow whenever the BATH Fill operating light is on.
- Whilst water is flowing from a hot tap during the bath fill operation (bath fill operating light is on), a Deluxe controller cannot be turned on or off:
  - if it is on, pressing the on / off (🔌) button will not turn it off
  - if it is off, pressing the on / off (🔌) button will not turn it on.
- Whilst there is no water flowing from a hot tap and the bath fill operating light is on, a Deluxe controller can be turned on (on / off (🔌) button glows), but it will not gain priority (PRIORITY light will not glow).
- Pressing the up (▲) button or down (▼) button above the on / off (🔌) button during the bath fill operation (bath fill operating light is on) will not adjust the temperature setting.

**Important**

- Ensure all hot taps are turned off after a bath fill operation is complete and before pressing the bath fill (🚿) button “off”. Otherwise;
  - Water will flow from the hot tap when the bath fill (🚿) button is pressed “off”.  
The water will be cold if all Deluxe controllers are off, or hot if a Deluxe controller has PRIORITY.
  - The voice prompt will also sound;  
*“please ensure the bath hot water tap is turned off”.*

### Opening a Second Hot Water Tap During Bath Fill Operation

- The bath fill water volume is measured as the water flows through the water heater. If more than one hot tap is open, the Bath Fill function will measure the total water volume drawn from all taps and the expected water volume from the first tap will be decreased.
  - If the hot water supply should cease unexpectedly, check to see if the bath fill operating light is flashing
  - If the bath fill operating light is flashing, this indicates the set bath fill water volume has been delivered and the bath fill operation is complete
  - If further hot water is required for the application:
    - Turn off the hot tap
    - Press the bath fill (🚿) button to turn off the Bath Fill function
    - Recommence the Bath Fill procedure from Step 3, ensuring the water volume is adjusted to the volume required to complete the application.

### Early Completion of Bath Fill Operation

- If the hot tap is closed before the set water volume flows through the water heater and the bath fill (🚿) button is left on, the Bath Fill function remains active for six hours.
  - If during this time a hot tap is turned on, the bath fill operation continues until the remaining bath fill water volume is consumed, then
 

The water flow will cease and the voice prompt will sound;

*“the bath is ready, please turn off the hot water tap and press the bath fill (🚿) button to finish”*

    - Close the hot tap
    - Press the bath fill (🚿) button
  - To prevent the bath fill operation completing and interrupting the hot water supply, whilst the hot tap is off, then
    - press the bath fill (🚿) button twice to turn it off
 

The first press of the bath fill (🚿) button causes the bath fill operating light to flash and the voice prompt will sound

*“bath filling has been stopped, please turn off the hot water tap and press the bath fill (🚿) button to finish”*

The second press of the bath fill (🚿) button causes the bath fill operating light to go off.

### Interrupting Bath Fill Operation

- The bath fill operation can be interrupted by:
  - Pressing the bath fill (🚿) button before completion of the bath fill operation
 

Refer to [“Turning Off Bath Fill Function During Its Operation”](#) on page 37.

or by
  - Pressing and holding the on / off (🔌) button on any Deluxe controller for three seconds.
 

This turns off all the Deluxe controllers, including the Bath Fill function. The displays go blank and the lights go out.

A voice prompt will sound;

*“bath filling has been stopped”*

Hot water flowing from a hot tap will go cold.

    - Turn off the hot tap.

**Operation of the Bath Fill function whilst a Deluxe Controller has priority**

It is recommended the Bath Fill function be set and operated with the Deluxe controllers turned off (refer to [Step 1](#) on page 34).

However, if a Deluxe controller has PRIORITY during the setting and operation of the Bath Fill function, then the following additional events occur:

**During Step 3**, when the bath fill temperature is being set

- The temperature setting of the PRIORITY Deluxe controller will display in the temperature display panel three seconds after the BATH FILL TEMPERATURE button is last pressed.

When the Deluxe controller temperature setting is higher than the bath fill temperature setting, the voice prompt will sound;

*“hot water temperature has been increased”*

When the Deluxe controller temperature setting is lower than the bath fill temperature setting, the voice prompt will sound;

*“hot water temperature has been decreased”*

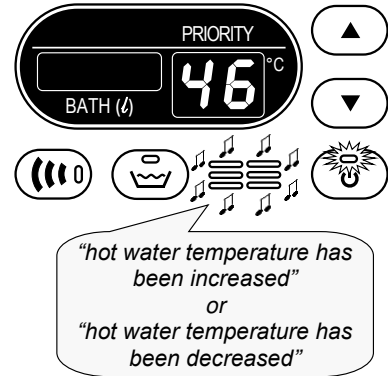

**During Step 6**, when the bath fill (🛁) button is pressed to turn the Bath Fill function on

The Bath Fill function has priority when operating. When the bath fill (🛁) button is pressed, the Bath Fill function will gain priority and over-ride the settings of all Deluxe controllers if they are on.

- The PRIORITY light will go out if it is on.
- The bath fill temperature setting will replace the temperature setting in the temperature display panel.

When the bath fill temperature setting is lower than the Deluxe controller temperature setting, the voice prompt will sound;

*“hot water temperature has been decreased”*

When the bath fill temperature setting is higher than the Deluxe controller temperature setting, the voice prompt will sound;

*“hot water temperature has been increased”*

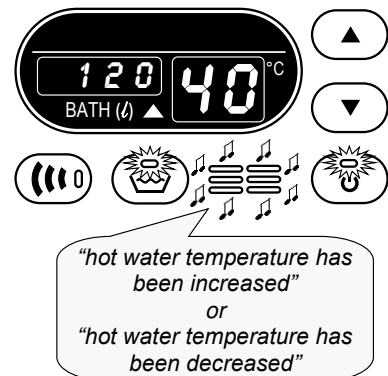

**During Step 9**, when the bath fill (🛁) button is pressed to turn the Bath Fill function off

- The PRIORITY light will glow on the Deluxe controller which has priority.
- The temperature setting of the PRIORITY Deluxe controller will display in the temperature display panel.



**Notes**

- If it is a Bathroom Deluxe controller which is in use and it is on, i.e. it has priority and the PRIORITY light is glowing, then it is advised to leave the controller on.

Refer to the [warning](#) in the notes on page 30.

- If it is the Kitchen Deluxe controller which is in use and it is on, i.e. it has priority and the PRIORITY light is glowing, then it is advised to turn the controller off.

Refer to [Important](#) note for Bathroom controllers on page 30.

---

# WATER SUPPLIES

---

**This water heater must be installed in accordance with this advice to be covered by the Rheem warranty.**

This water heater is manufactured to suit the water conditions of most public reticulated water supplies. However, there are some known water chemistries which can have detrimental effects on the water heater and its operation and / or life expectancy. If you are unsure of your water chemistry, you may be able to obtain information from your local water supply authority. This water heater should only be connected to a water supply which complies with these guidelines for the Rheem warranty to apply.

## CHANGE OF WATER SUPPLY

The changing or alternating from one water supply to another can have a detrimental effect on the operation and / or life expectation of a heat exchanger in a continuous flow water heater.

Where there is a changeover from one water supply to another, e.g. a rainwater tank supply, bore water supply, desalinated water supply, public reticulated water supply or water brought in from another supply, then water chemistry information should be sought from the supplier or it should be tested to ensure the water supply meets the requirements given in these guidelines for the Rheem warranty to apply.

## SATURATION INDEX

The saturation index (SI) is used as a measure of the water's corrosive or scaling properties.

In a corrosive water supply, the water can attack copper parts and cause them to fail. Where the saturation index is less than  $-1.0$ , the water is very corrosive and the Rheem warranty does not apply to a copper heat exchanger in a continuous flow water heater.

In a scaling water supply calcium carbonate is deposited out of the water onto any hot metallic surface. Where the saturation index exceeds  $+0.80$ , the Rheem warranty does not apply to a copper heat exchanger in a continuous flow water heater.

Water which is scaling may be treated with a water softening device to reduce the saturation index of the water.

Refer to the [Saturation Index chart](#) on page 41.

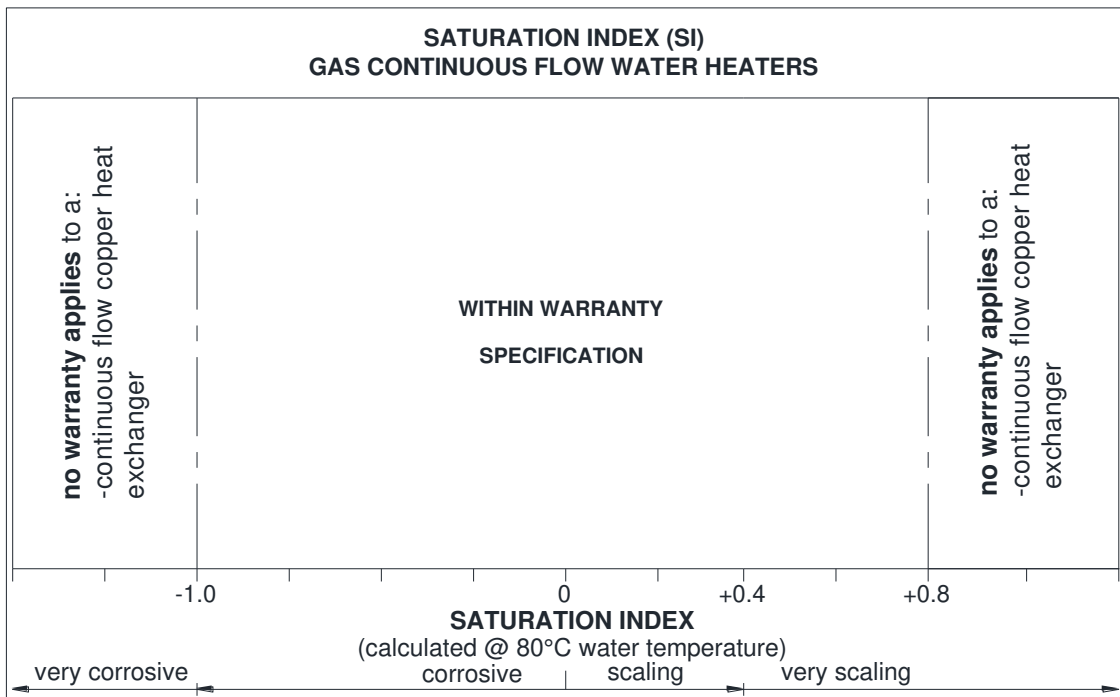

---

## SAVE A SERVICE CALL

---

Check the items below before making a service call. You will be charged for attending to any condition or fault, which is not related to manufacture or failure of a part (refer to “[Terms of the Rheem Warranty](#)” on page 83).

### NO DISPLAY ON THE CONTROLLER

- Is the controller turned on?  
Press the on / off (⏻) button (refer to “[Temperature Control](#)” on pages 11 to 40).
- Is the water heater plugged in and the power outlet switched on?
- Is power available in the house?  
Try using another electrical appliance.

### COLD WATER FROM THE HOT TAP

- Is the controller turned on?  
Press the on / off (⏻) button (refer to “[Temperature Control](#)” on pages 11 to 40).
- Close the hot tap, wait 10 seconds and open the hot tap again.
- Is the hot tap open enough?  
The burners will not light if the flow rate is less than 2.5 L / min.
- Is the water heater plugged in and the power outlet switched on?
- Is power available in the house?  
Try using another electrical appliance.
- Is the isolation valve in the gas line open?
- Is there a gas supply to the rest of the house?  
Try lighting another gas appliance.
- Has the gas line been purged of air after installation?  
Refer to your plumber.

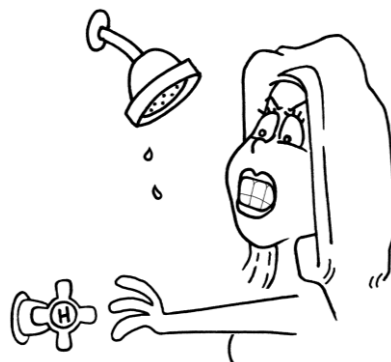

### WATER IS TOO HOT OR NOT HOT ENOUGH

- Does the controller you are using have priority? (refer to “[Temperature Control](#)” on pages 11 to 40)  
**Note:** For an 876 series water heater, 48°C is the maximum available temperature.

### REDUCED HOT WATER FLOW WHEN HEAT EXCHANGER IS COLD

At a cold start-up, i.e. when the water heater has not operated for some time (which is most often first thing in the morning), the initial flow of hot water may be reduced for a period of 5-10 seconds while the heat exchanger warms up. **This is both an energy and water saving feature of this water heater.** Once the heat exchanger has warmed up the hot water flow will increase and remain at normal flow levels. This feature will only occur at a cold start-up and not when the heat exchanger is already warm from a recent use of hot water.

### NO WATER FROM THE HOT TAP

No flow of water from the hot tap may indicate a restriction in or failure of the cold water supply to the water heater. Check for water flow at other taps and that the cold water isolation valve ([refer to page 58](#)) is fully open.

### WATER FLOW FLUCTUATES

More than one or two hot taps in use at the same time may cause a decrease in the hot water flow from the taps. This can also be evident if the water heater has been installed as an in-series gas booster to a solar water heater and the solar heated water is at a low temperature.

- Are there more than one or two hot taps open, or are appliances such as a dishwasher or washing machine, in use at the same time?

Ensure only one or two hot taps (or appliance) are on at the one time.

- Check the flow of the water from one tap, e.g. the shower.

The shower should be adjusted so the hot tap is fully open.

### GAS BOOSTER OPERATING TOO FREQUENTLY

If the water heater is installed as an in-series gas booster to a solar water heater, you may find that the water heater operates more frequently than expected. This will occur when the solar heated water temperature is lower than 58°C, which may be experienced during periods of low solar energy gain or if there has been heavy hot water usage. Factors to consider are:

- **Hot tap not used recently**

If a hot tap has not been used for a while, the water in the pipe work between the solar water heater and the in-series gas booster may have cooled down. The in-series gas booster will sense the cooler water and this will cause the burners on the water heater to ignite and boost the water temperature when a hot tap is first turned on. The burners will extinguish when solar heated water of 58°C or higher from the solar storage tank reaches the in-series gas booster (refer also to "[Fan Continues to Run after Water Heater Operation Stops](#)" on page 43).

- **Insufficient sunlight**

Insufficient sunlight due to cloudy weather during hotter months or low solar energy contribution in colder months may mean the in-series gas booster operates more often.

- **Collectors shaded**

If trees or other objects shade the solar collectors or if the glass is dirty, the effectiveness of the solar collectors will be greatly reduced. Have the trees trimmed or the solar collectors relocated if the obstruction is permanent or clean the collector glass.

Ensure the glass on your solar collectors is free of dust, salt spray or any other matter, which may reduce the effectiveness of the solar collectors. If the collector glass becomes dirty, hose down or if the solar collectors are accessible, wash the collector glass with water and a soft brush when the solar collectors are cool.

- **Collector area is too small**

For most installations, the number of solar collectors recommended in Rheem literature has been proven to provide the required solar energy to meet the average family needs. However, in some circumstances, it may be necessary to install an additional solar collector.

- **Are you using more hot water than you think?**

Is one outlet (especially the shower) using more hot water than you think?

Very often it is not realised the amount of hot water used, particularly when showering. Carefully review the family's hot water usage. As you have installed an energy saving appliance, energy saving should also be practised in the home. Adjust your water usage pattern to take advantage of maximum solar gains.

Have your plumber install a flow control valve to each shower outlet, basin and sink to reduce water usage.

- **Water heater size**

Do you have the correct size water heater for your requirements?

The sizing guide in the sales literature and on the Rheem website ([www.rheem.com.au](http://www.rheem.com.au)) suggests average sizes that may be needed.

### FAN CONTINUES TO RUN AFTER WATER HEATER OPERATION STOPS

It is the normal operation of the water heater for the fan to continue running after heating of the water is finished. The fan may run for up to six minutes after the burners extinguish, to prepare for the next ignition.

### CLOUDS OF WHITE 'VAPOUR' FROM THE FLUE TERMINAL

During the heating cycle, it is not unusual to see water vapour clouds steaming from the flue terminal, particularly on cold days. This is normal operation of the water heater.

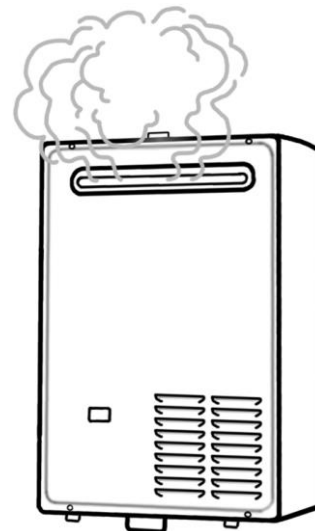

### PRESSURE RELIEF VALVE DISCHARGING

A pressure relief valve is incorporated into the water heater controls. This valve protects the water heater, by allowing water to escape, in the event of excessive pressure build-up in the waterways.

- **Normal operation**

A small volume of water may discharge from the bottom of the water heater when a hot tap is suddenly closed.

- **Continuous dribble**

A continuous dribble may indicate the water supply pressure is above the design pressure for the water heater. If so, a pressure limiting valve must be installed on the cold water supply pipe to the water heater (refer to ["Mains Water Supply"](#) on page 48).

### ERROR CODE

The water heater provides a diagnostic error code in the event of an interruption to its operation. The error code is displayed on the controller(s) (if installed) as a numerical value and on the OK MONITOR on the front of the water heater as a series of flashes.

- Close the hot tap, turn off the controller(s) and switch off the electrical supply to the water heater.
- Check the gas isolation valve at the gas inlet to the water heater is fully open.
- Wait 5 minutes, then switch on the electrical supply to the water heater, turn on a controller and open a hot tap.



If the error code persists, take note of the numerical code if a controller(s) is installed and the number of flashes on the OK MONITOR, turn off the hot tap and turn off the controller(s). Phone Rheem Service or their nearest Accredited Service Agent to arrange for an inspection.

### HIGHER THAN EXPECTED GAS BILLS

Should you at any time, feel your gas bill is higher than expected, we suggest you check the following points:

- Is one outlet (especially the shower) using more hot water than you think?

Carefully review the family's hot water usage. Inexpensive flow control valves can be easily fitted to the shower outlets to reduce water usage.

- Is the in-series gas booster operating too frequently?

Refer to ["Gas Booster Operating Too Frequently"](#) on page 43.

- Has there been an increase in hot water usage?

An increase in hot water usage will result in an increase in water heater operation.

- Has your water heating tariff rate been increased by your gas retailer since your previous bill?



**IF YOU HAVE CHECKED ALL THE FOREGOING AND STILL BELIEVE YOU NEED ASSISTANCE, PHONE RHEEM SERVICE OR THEIR NEAREST ACCREDITED SERVICE AGENT.**

---

# INSTALLATION – WATER HEATER

---

**THIS WATER HEATER IS FOR OUTDOOR INSTALLATION ONLY.  
THIS WATER HEATER IS NOT SUITABLE FOR POOL HEATING.  
Check the water heater is suitable for the gas type available.  
(refer to the rating label on the water heater)**

## INSTALLATION STANDARDS

The water heater must be installed:

- by a qualified person, and
- in accordance with the installation instructions, and
- in compliance with Standards AS/NZS 3500.4, and either AS 5601 or AS/NZS 5601.1 as applicable under local regulations, and all local codes and regulatory authority requirements.

The Gas installations Standards AS 5601 and AS/NZS 5601.1 place limitations on the location of a gas water heater within a covered area. Refer to [“Installation within a Covered Area”](#) on page 47.

All packaging materials must be removed from the water heater, including the packing piece in the flue outlet, prior to its installation.

## WATER HEATER APPLICATION

This water heater is designed for use in a single family domestic dwelling for the purpose of heating potable water. Its use in an application other than this may shorten its life.

If this water heater is to be used where an uninterrupted hot water supply is necessary for the application or business, then there should be back-up redundancy within the hot water system design. This should ensure the continuity of hot water supply in the event that this water heater was to become inoperable for any reason. We recommend you provide advice to the system owner about their needs and building back-up redundancy into the hot water supply system.

The 874 series of water heater may be installed as an in-series gas booster to a solar water heater. For information relating to the function and operation of the solar water heater, refer to the Owner’s Guide and Installation Instructions supplied with the solar water heater.

**Note:** The 876 series water heater is marked “THIS APPLIANCE DELIVERS WATER NOT EXCEEDING 50°C IN ACCORDANCE WITH AS 3498” on the front panel. This model;

- **must not** be installed as an in-series gas booster to a solar water heater, as water temperature greater than 50°C can be delivered from the water heater contravening its compliance to AS 3498.

**Note:** AS 3498 requires that a water heater provides the means to inhibit the growth of Legionella bacteria in potable water. When this water heater is used as an in-series booster for a solar water heater it can satisfy this AS 3498 requirement provided it is energised, the booster preset outlet temperature setting is 70°C, and that a remote temperature controller is not used.

## WATER HEATER LOCATION

The water heater is suitable for outdoor installation only and should be installed close to the most frequently used outlet and its position chosen with safety and service in mind. If this water heater is part of a solar water heater system, it should also be installed close to the solar storage tank. Make sure people (particularly children) will not touch the flue terminal. The flue terminal and air inlet must be clear of obstructions and shrubbery.

Clearance must be allowed for servicing of the water heater. The water heater must be accessible without the use of a ladder or scaffold. Make sure the entire front panel can be removed for service. You must be able to read the information on the rating plate. Remember you may have to take the entire water heater out later for servicing.

This water heater must be installed vertically upright with the water, gas and power connections on the underside, pointing toward the ground. The back of the water heater can be either against a wall or supported by a frame.

**Note:** The water heater must be well secured to the wall or frame using two fasteners each at the top and bottom of the unit (refer to page 54 for [mounting hole positions](#) and weight of the water heater). Use the screws provided only if they are suitable for the wall or frame type. Otherwise select and use alternative fasteners suitable for the application. The fasteners must be capable of bearing the full weight of the water heater so it may not work loose nor impose any load on the gas and water pipe work connected to the water heater. Refer to the fastener manufacturer's information and recommendations for the type of fastener to use for the wall or frame type and load bearing requirements.



Alternatively the water heater can be recessed into a wall (refer to [“Recess Installation”](#) on page 48).

For a single water heater installation, refer to the [typical installation diagram](#) on page 57.

For a dual water heater installation using the Ez-Link system, refer to [“Ez-Link System Dual Installation”](#) on page 60 and the [typical installation diagram](#) on page 64.

The water heater must not be installed in an area with a corrosive atmosphere where chemicals are stored or where aerosol propellants are released. Remember the air may be safe to breathe, but when it goes through a flame, chemical changes take place which may attack the water heater.

A secondary flue is not required. The water heater must not be installed indoors or in a confined space.

The water heater must be located to ensure that the location of the flue terminal complies with the requirements of AS 5601 or AS/NZS 5601.1, as applicable under local regulations. As a guide the following requirements are extracted from the Gas Installations Standard. The distances are measured along the wall behind the water heater.

- At least 300 mm between the top of the flue terminal and the eaves.
- At least 300 mm between the flue terminal and the edge of any opening into the building, such as an openable door or window, measured horizontally\*.
- At least 1500 mm between the top of the flue terminal and the edge of any opening into the building, such as an openable window, measured vertically.
- At least 300 mm between the flue terminal and a return wall or external corner, measured horizontally\*.
- At least 1500 mm between the flue terminal and any opening into a building, in the direction of the flue discharge.
- At least 500 mm between the flue terminal and a fence, wall or other obstruction, in the direction of the flue discharge.

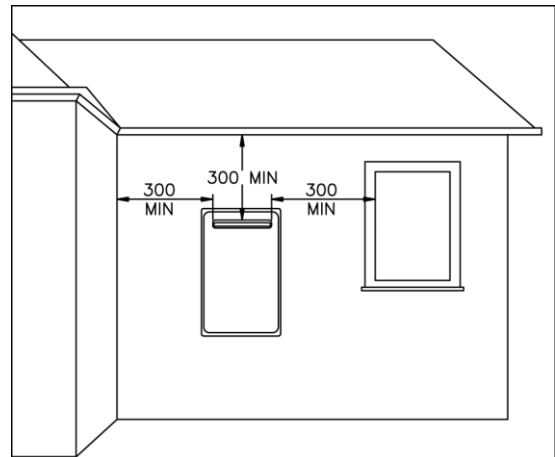

**Note:** \* If these horizontal distances cannot be achieved, AS/NZS 5601.1 states an equivalent horizontal distance measured diagonally from the nearest discharge point of the flue terminal to the opening may be deemed to comply. Check with the local regulator.

**INSTALLATION WITHIN A COVERED AREA**

The water heater must be located such that the installation meets the requirements of either AS 5601 or AS/NZS 5601.1 as applicable under local regulations. There must be sufficient ventilation so the water heater has an adequate supply of combustion air and the flue products are dispersed safely. It is the licensed installer’s responsibility to ensure the installation complies with the relevant sections of the prevailing Gas installations Standard.

Installation of this water heater is permitted within a covered area open on at least two sides, if its flue terminal is located to ensure a free flow of air across it is achieved.

AS/NZS 5601.1 also allows the installation of a continuous flow gas water heater within a covered area open on one side only if the flue terminal is within 500 mm of the opening, is discharging in the direction of the opening, there are no openings into the building along the wall within the 500 mm distance and the terminal is located to ensure a free flow of air across it is achieved.

A Rheem 874 or 876 series 12NF or 16NF model fitted with a Rheem Flue Terminal Diverter (kit number 299881) in accordance with its installation instructions, can be installed to meet this requirement.

A Rheem 874 or 876 series 12NF or 16NF model water heater can also be installed on a side wall within a covered area (open on one side only), and meet the installation requirements of AS 5601 and AS/NZS 5601.1, if it is fitted with a Rheem Flue Terminal Diverter (kit number 299281) and positioned so that the outlet of the Flue Terminal Diverter is level with or beyond the outer edge of the side wall of the covered area.

A Rheem Flue Terminal Diverter can be fitted to a Rheem 874 or 876 series 12NF or 16NF model installed in a recess box. Refer to “[Recess Installation](#)” on page 48.

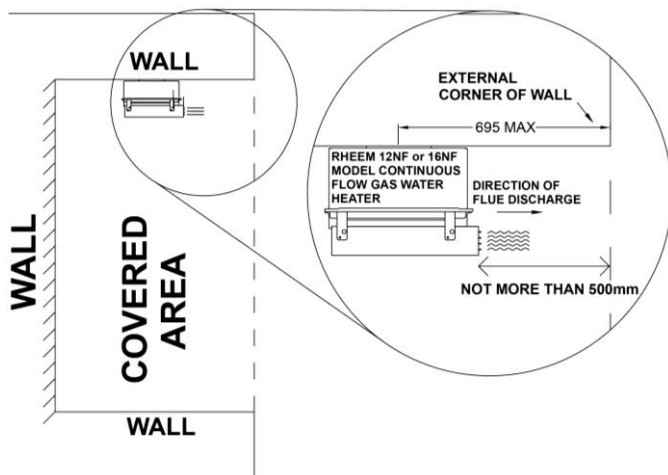

12NF or 16NF model with a Flue Terminal Diverter installed in compliance with AS/NZS 5601.1

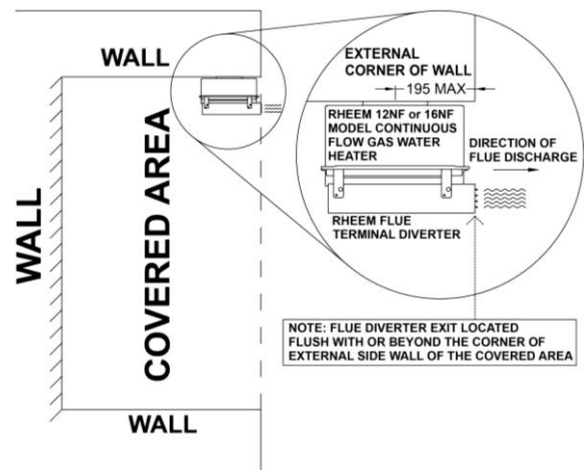

12NF or 16NF model with a Flue Terminal Diverter installed in compliance with AS 5601 and AS/NZS 5601.1

**PIPE COVER**

The pipe work to the water heater can be housed within a pipe cover. A pipe cover kit (PN 299841 – antique white finish) is available for such an installation. Refer to the installation instructions which accompany the pipe cover kit.



**RECESS INSTALLATION**

The water heater can be installed recessed into a wall. A recess box (PN 299842) is available for such an installation. Refer to the installation instructions which accompany the recess box kit for information on its installation.

An additional rating label is supplied attached to the inside of the front cover of the water heater. This is for a service person to access the water heater details when required. The rating plate on the side of the water heater should be moved to or the information copied onto either the front panel of the water heater or to another position which is visible when the water heater is installed so the householder can access the water heater details when required.

**Note:** If the recess box is installed under a covered area, refer to “Installation within a Covered Area” on page 47.

**FROST PROTECTION**

The water heater has a frost protection system. The frost protection system will protect the water heater from damage, by preventing ice forming in the waterways of the water heater, in the event of freezing conditions occurring.

The frost protection system will be rendered inoperable if electrical power is not available at the water heater. Damage to the water heater caused by freezing of the pipe work to or from the water heater is not covered under the Rheem warranty. Refer to AS/NZS 3500.4 for precautions to be taken for installations in frost prone areas. The water heater is not suitable for installation in areas where the ambient temperature falls below -20°C (including wind chill factor).

The cold water line to the water heater must be insulated with suitable thickness insulation if freezing conditions are likely to occur. The insulation must be fitted to the underside of the water heater and be weatherproof and UV resistant if exposed.

**MAINS WATER SUPPLY**

Where the mains water supply pressure exceeds that shown in the table below, an approved pressure limiting valve that does not have non-return valve characteristics (such as an RMC PSL series valve) is required and should be fitted as shown in the installation diagram (refer to page 57).

Model	12 – 20
Relief valve setting	1750 kPa
Max. mains supply pressure	1000 kPa
Min. mains supply pressure *	140 kPa

\* minimum water supply pressure required to achieve the rated flow and performance

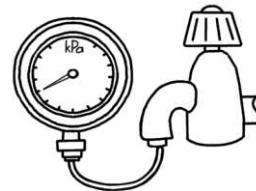

**Notes:**

- It is not recommended to install this water heater with a low pressure water supply.
- A minimum water supply pressure of 140 kPa is required to achieve the rated flow and performance of the water heater.
- If this water heater is installed as an in-series gas booster for a solar water heater, the maximum water supply pressure to the solar water heater, without an expansion control valve (ECV), is generally 800 kPa, however it may be less than this for some models. Refer to the Owner’s Guide and Installation Instructions supplied with the solar water heater for maximum mains supply pressure details.
- If sludge or foreign matter is present in the water supply, it is recommended a suitable filter be incorporated in the cold water line to the water heater.
- This water heater is not suitable for connection to bore water or spring water unless a water treatment device is fitted.
- Refer to “Water Supplies” on page 41 for further information on water chemistry.

## HOT WATER DELIVERY

This water heater can deliver water at temperatures which can cause scalding.

It is necessary and we recommend that a temperature limiting device be fitted between an 874 series water heater and the hot water outlets in any ablution and public areas such as a bathroom, ensuite or public amenities, to reduce the risk of scalding. The installing plumber may have a legal obligation to ensure the installation of this water heater meets the delivery water temperature requirements of AS/NZS 3500.4 so that scalding water temperatures are not delivered to a bathroom, ensuite or other ablution or public area.

The temperature limiting device used with a continuous flow gas water heater should have:

- a specified 'minimum temperature differential' between the hot water inlet and the tempered water outlet of no greater than 10°C, and
- a specified 'maximum permitted pressure variation' in the supply between the hot water inlet and the cold water inlet of no less than 15%.

Refer to the specifications of the temperature limiting device.

Where a temperature limiting device is installed adjacent to the water heater, the cold water line to the temperature limiting device can be branched off the cold water line either before or after the isolation valve and pressure limiting valve to the water heater.

If a pressure limiting valve is installed on the cold water line to the water heater and the cold water line to a temperature limiting device branches off before this valve or from another cold water line in the premises, then a pressure limiting valve of an equal pressure setting may be required prior to the temperature limiting device.

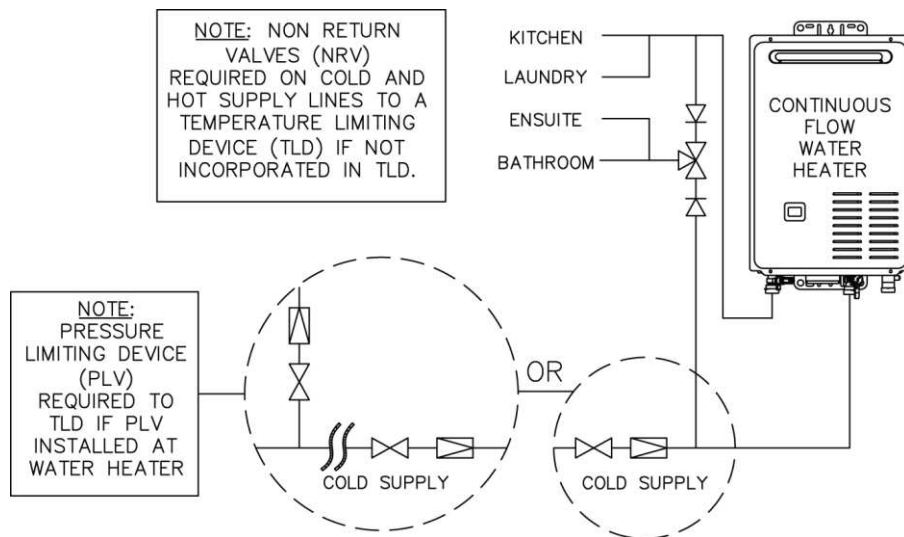

**Two Temperature Zones Using a Temperature Limiting Device**

An 876 series water heater will not deliver temperatures exceeding 50°C in accordance with AS 3498. There is no need to fit a temperature limiting device to satisfy the requirements of AS/NZS 3500.4, if an 876 series water heater is installed in an application where 50°C is the maximum permissible hot water temperature at the outlet of a sanitary fixture used primarily for personal hygiene purposes. Refer to [“Water Temperature Diagrams”](#) on page 53.

### In-series gas booster for a Solar Water Heater

The temperature limiting device used with an 874 series in-series gas booster as part of a solar water heater installation must have the additional capability of receiving a hot water supply temperature of up to 99°C if the solar water heater does not have an over temperature protection system to limit the water to no greater than 90°C, such as the Rheem Premier Hiline thermosiphon closed circuit indirect system.

**⚠** Temperature controllers **must not** be fitted to this water heater (874 series) if it is installed as an in-series gas booster with a solar water heater system because water at a temperature much higher than the controller setting can be delivered. If a solar water heater has been installed to an existing water heater installation, then all controllers **must be** disconnected and removed.

Where a temperature limiting device is installed adjacent to the in-series gas booster, the cold water line to the temperature limiting device can be branched off the cold water line either before or after the isolation valve and pressure limiting valve to the solar storage tank, but it **MUST BE** before the non-return valve prior to an open circuit direct system. The cold water line to the temperature limiting device can be branched off the cold water line either before or after the non-return valve prior to a closed circuit indirect system. If an expansion control valve is required, it must always be installed after the non-return valve and be the last valve prior to the solar storage tank.

**⚠ Warning:** A non-return valve **MUST BE** installed on the cold water line to the solar storage tank **AFTER** the cold water branch to a temperature limiting device prior to an open circuit direct system. Due to the higher water temperatures generated under certain conditions in the solar collectors of an open circuit direct solar water heater, an additional effective back-flow prevention device also should be used as an extra safeguard. Valve manufacturer RMC recommends Dual Check Valve model N7150, as being suitable for this application.

If a combination isolation valve and non-return valve (duo or trio valve) is installed on the cold water line to an open circuit direct solar water heater and the cold water line to the temperature limiting device branches off after this valve, then a second non-return valve must be installed between the cold water branch and the solar storage tank. Due to the higher water temperatures generated under certain conditions in the solar collectors of an open circuit direct pumped solar water heater, an effective back-flow prevention device should be used as the second non-return valve as an extra safeguard. Valve manufacturer RMC recommends Dual Check Valve model N7150, as being suitable for this application.

If a pressure limiting valve is installed on the cold water line to the solar water heater and the cold water line to a temperature limiting device branches off before this valve or from another cold water line in the premises, then a pressure limiting valve of an equal pressure setting may be required prior to the temperature limiting device.

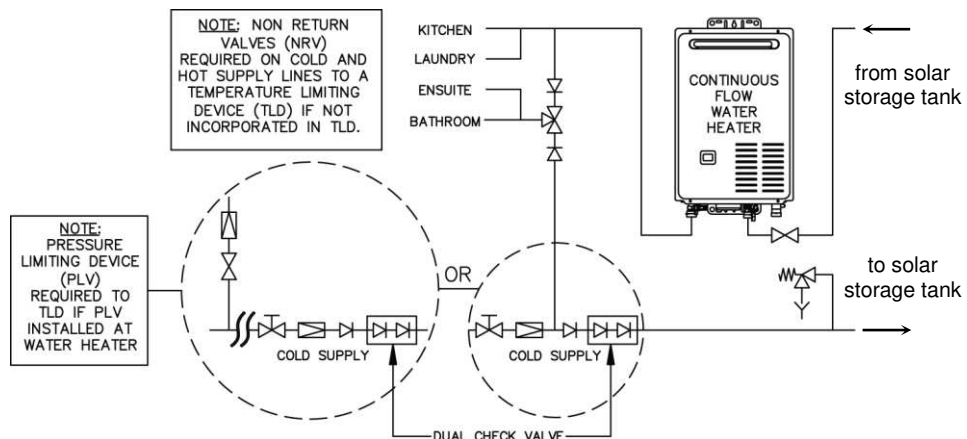

**In-series Gas Booster as part of a Open Circuit Direct Solar Water Heater Installation  
Two Temperature Zones Using a Temperature Limiting Device**

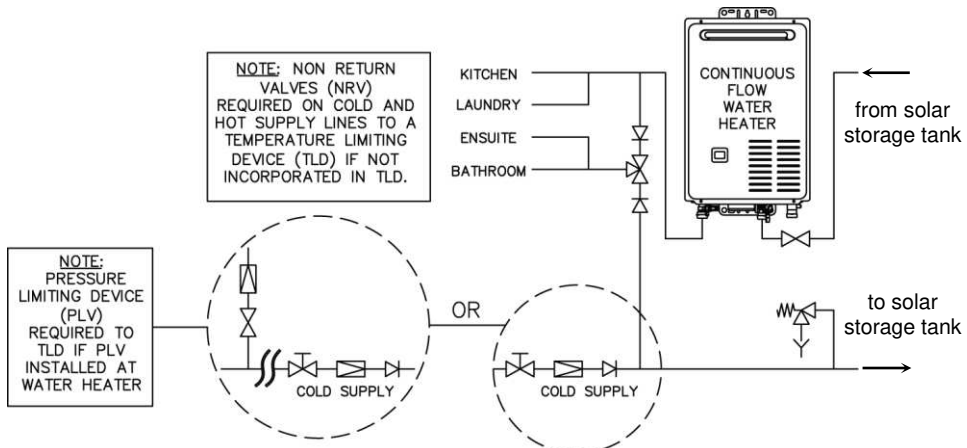

**In-series Gas Booster as part of a Closed Circuit Indirect Solar Water Heater Installation  
Two Temperature Zones Using a Temperature Limiting Device**

## CIRCULATED HOT WATER FLOW AND RETURN SYSTEM

A Rheem 874 series continuous flow water heater can be installed as part of a circulated hot water flow and return system in a building.

### Notes:

- the preset outlet temperature setting of the water heater must be set to at least 60°C.  
Water should not be circulated from a water heater with a temperature setting of less than 60°C.
- the preset outlet temperature setting of the water heater should be set to 70°C if the water temperature decreases by more than 5°C through a circulated hot water flow and return system due to heat loss in the ring main.
- temperature controllers should not be installed with a water heater as part of a circulated hot water flow and return system, including when installed as part of an Ez-Link System dual installation.

The circulator must be:

- sized and set to provide a minimum flow rate of 3.0 L/min through the recirculated hot water flow and return system, and
- either thermostatically and / or timer controlled.

The circulator **must not** be set to operate continuously, i.e. 24 hours per day.

**⚠ Warning:** A Rheem 876 series continuous flow water heater **must not** be installed as part of a circulated hot water flow and return system in a building.

### Temperature Limiting Device

A temperature limiting device cannot be installed in circulated hot water flow and return pipe work. The tempered water from a temperature limiting device cannot be circulated. Where a circulated hot water flow and return system is required in a building, a temperature limiting device can only be installed on a dead leg, branching off the circulated hot water flow and return pipe.

If circulated tempered water were to be returned back to the water heater, depending on the location of the return line connection on the water supply line to the water heater, then either:

- water will be supplied to the cold water inlet of the temperature limiting device at a temperature exceeding the maximum recommended water supply temperature, or
- when the hot taps are closed no water will be supplied to the cold water inlet of the temperature limiting device whilst hot water will continue to be supplied to the hot water inlet of the temperature limiting device.

These conditions may result in either water at a temperature exceeding the requirements of AS/NZS 3500.4 being delivered to the hot water outlets in the ablution areas, or the device closing completely and not delivering water at all, or the device failing. Under either condition, the operation and performance of the device cannot be guaranteed.

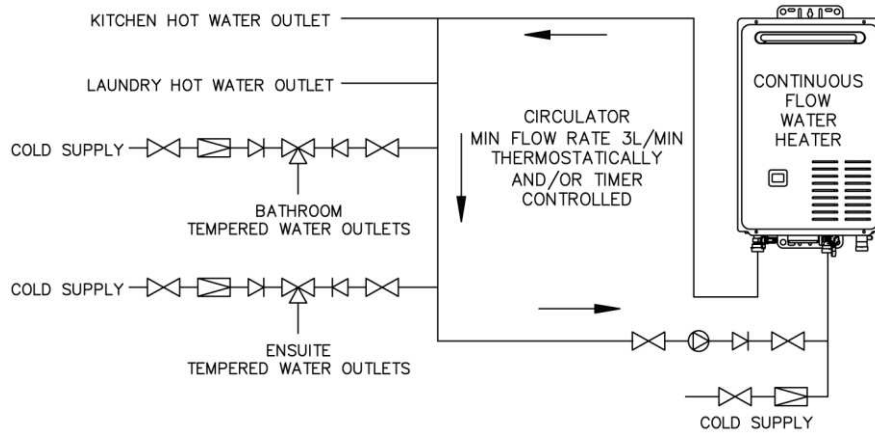

**NOTE:** A PLV IS REQUIRED TO BE INSTALLED ON THE COLD SUPPLY LINE TO THE TEMPERING VALVE IF A PLV IS INSTALLED ON THE COLD SUPPLY LINE TO THE WATER HEATER.  
 NON RETURN VALVES (NRV) REQUIRED ON COLD AND HOT SUPPLY LINES TO A TEMPERATURE LIMITING DEVICE (TLD) IF NOT INCORPORATED INTO TLD.

**Circulated Hot Water Flow and Return  
 Continuous Flow Gas Water Heater**

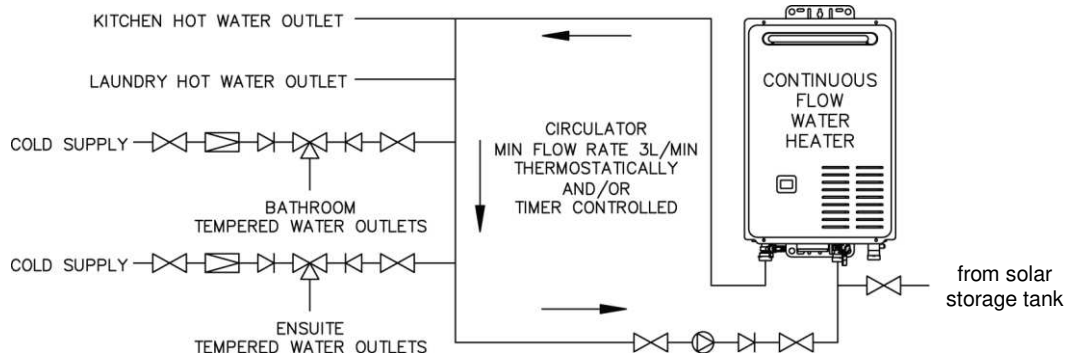

**NOTE:** A PLV IS REQUIRED TO BE INSTALLED ON THE COLD SUPPLY LINE TO THE TEMPERING VALVE IF A PLV IS INSTALLED ON THE COLD SUPPLY LINE TO THE WATER HEATER.  
 NON RETURN VALVES (NRV) REQUIRED ON COLD AND HOT SUPPLY LINES TO A TEMPERATURE LIMITING DEVICE (TLD) IF NOT INCORPORATED INTO TLD.

**Circulated Hot Water Flow and Return  
 In-series Gas Booster as part of a Solar Water Heater Installation**

**REDUCING HEAT LOSSES**

The hot water line from the water heater and the pipe work between the solar storage tank, if one is installed, and the in-series gas booster must be insulated in accordance with the requirements of AS/NZS 3500.4. The insulation must be weatherproof and UV resistant if exposed. The insulation must be fitted up to the connections on the both the underside of the water heater and the solar storage tank.



**WATER TEMPERATURE DIAGRAMS**

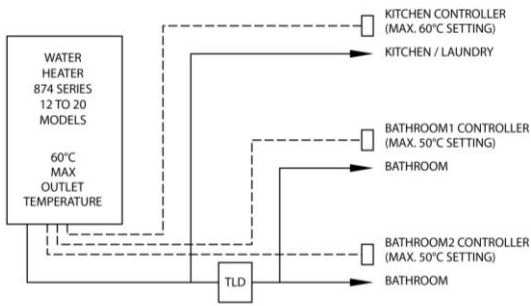

**874 Series - Kitchen and Bathroom Controllers**

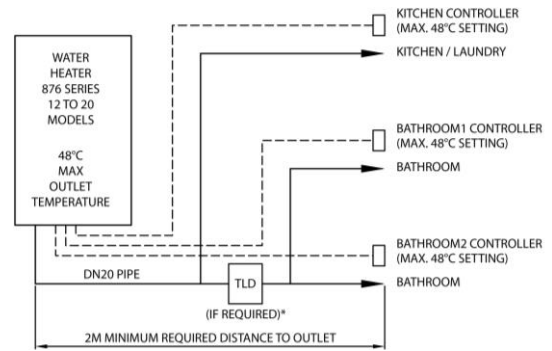

**876 Series – Kitchen and Bathroom Controllers**

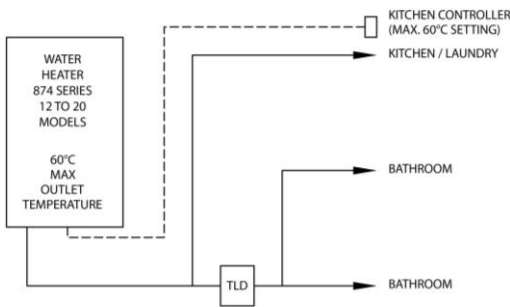

**874 Series - Kitchen Controller Only**

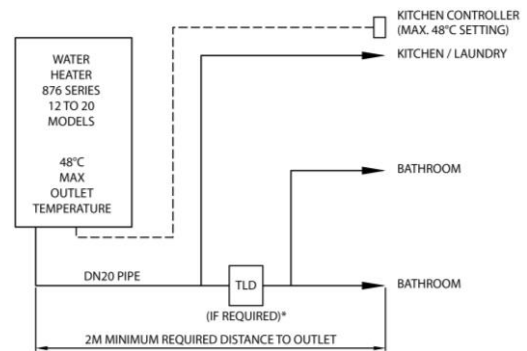

**876 Series - Kitchen Controller Only**

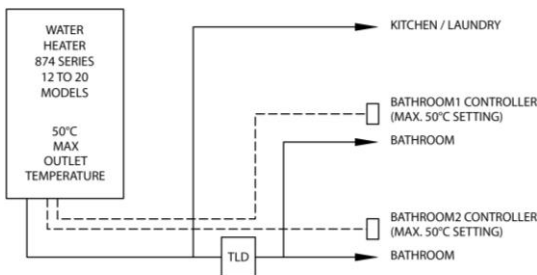

**874 Series - Bathroom Controllers Only**

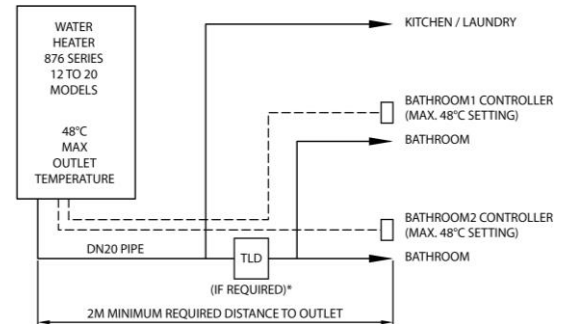

**876 Series - Bathroom Controllers Only**

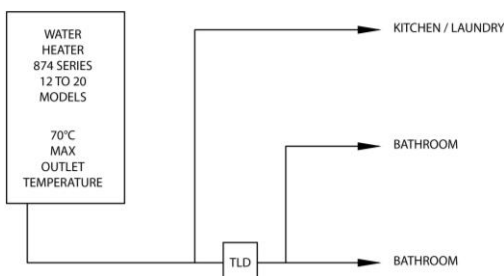

**874 Series - No Controllers**

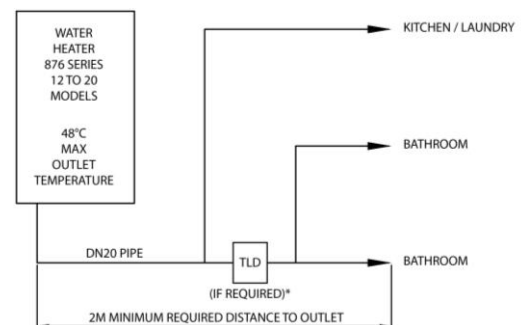

**876 Series - No Controllers**

**Notes:**

- Temperature Limiting Devices – refer to “Hot Water Delivery” on page 49.
- Factory preset outlet temperature setting is:
  - 874 series      60°C
  - 876 series      48°C



**DIMENSIONS AND TECHNICAL DATA**

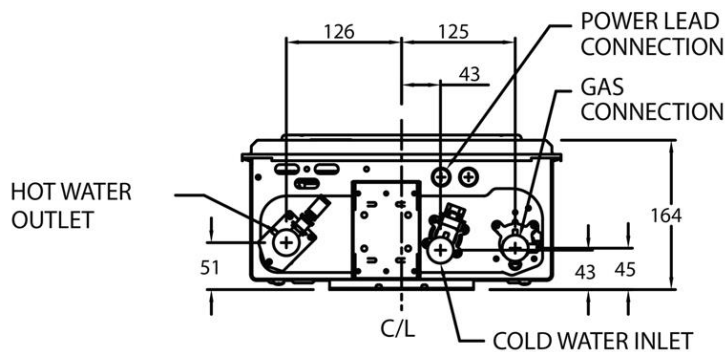
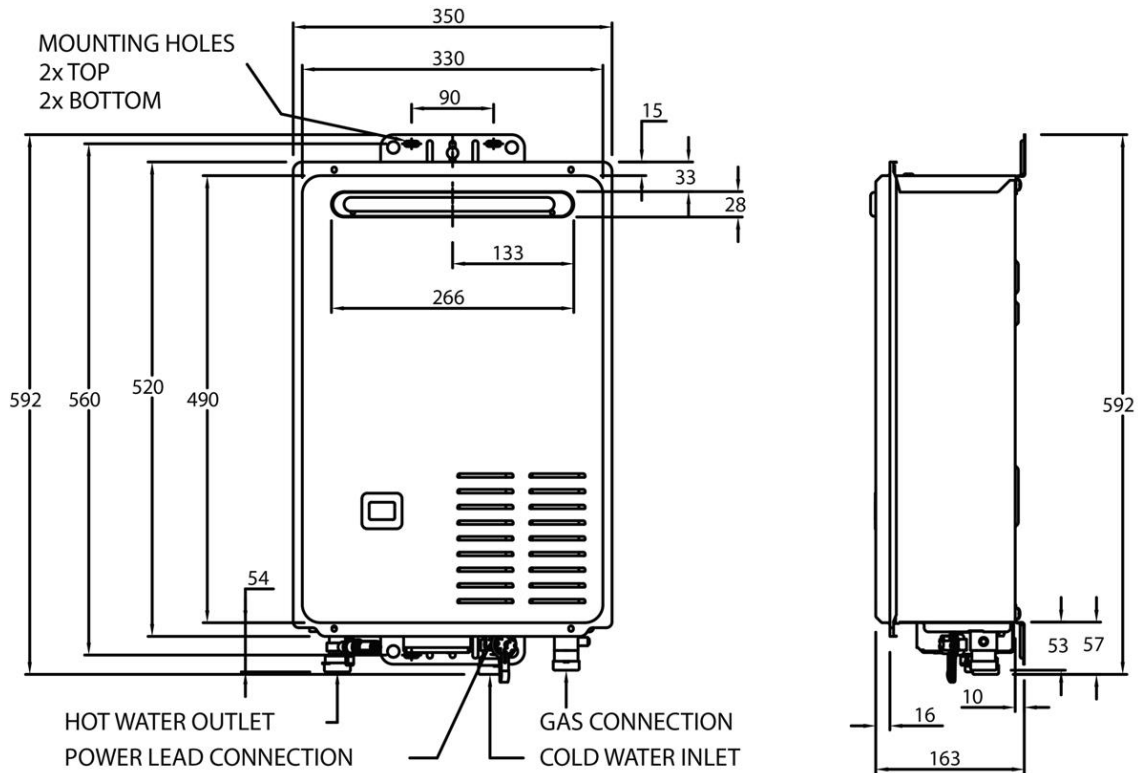

<b>Model</b>		874 612 876 612	874 616, 874 E16 876 616, 876 E16	874 618 876 618	874 620 876 620
<b>Rated delivery</b> (@ 40°C rise)	litres / min	7.5	10	11.3	12.5
<b>Recovery</b> (@ 25°C rise)	litres / min	12	16	18	20
<b>Mass</b> Empty (unpackaged)	kg	16	16	16	16

Gas Details	Hourly Gas Consumption (MJ)				Min. Gas Pressure (kPa)	Test Point Gas Pressure (kPa)						Max. Gas Pressure (kPa)
	612	616 E16	618	620		minimum			maximum			
						612	616 to 620, E16	618	612	616 E16	618	
Natural	94	126	140	153	1.13	0.190	0.170	0.810	0.620	0.755	0.870	3.50
Propane	94	126	140	153	2.75	0.160	0.190	0.920	0.770	0.930	1.185	3.50

Model numbers: N = Natural, P = Propane.

Letter N or P is included in the model number, e.g. 874620NF, 874620PF, to denote gas type.

F = Frost protection.

/J = Joey Grey coloured jacket, e.g. 874620NF/J – available on 874620 models only.

Technical data is subject to change.

**DIMENSIONS – STANDARD CONTROLLERS**

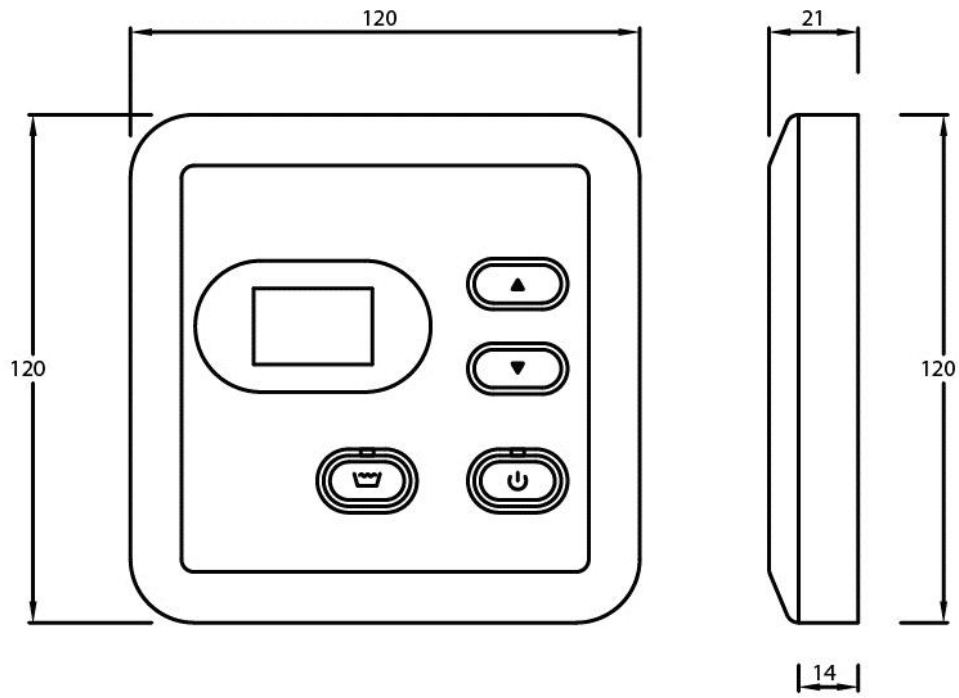

**Kitchen Controller (Standard)**

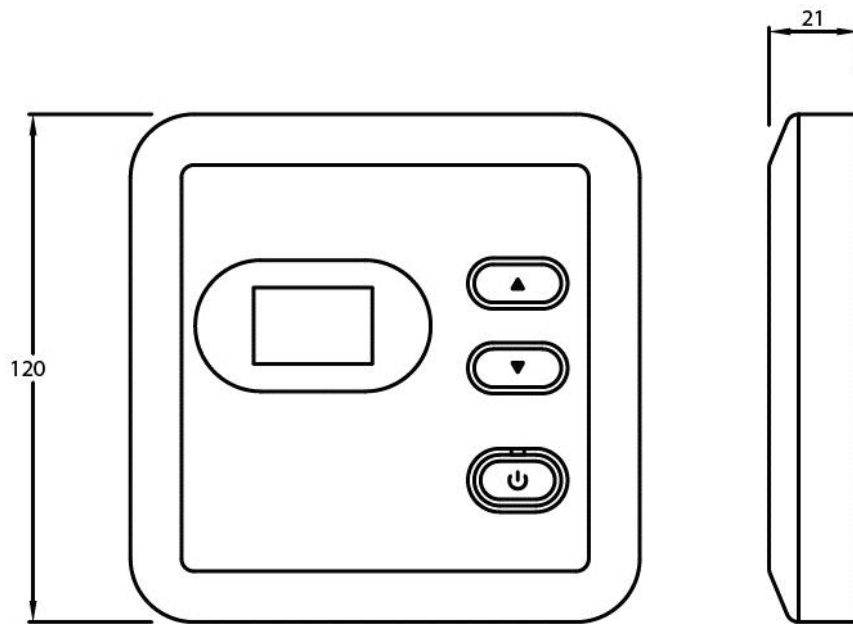

**Bathroom Controller (Standard)**



**DIMENSIONS – DELUXE CONTROLLERS**

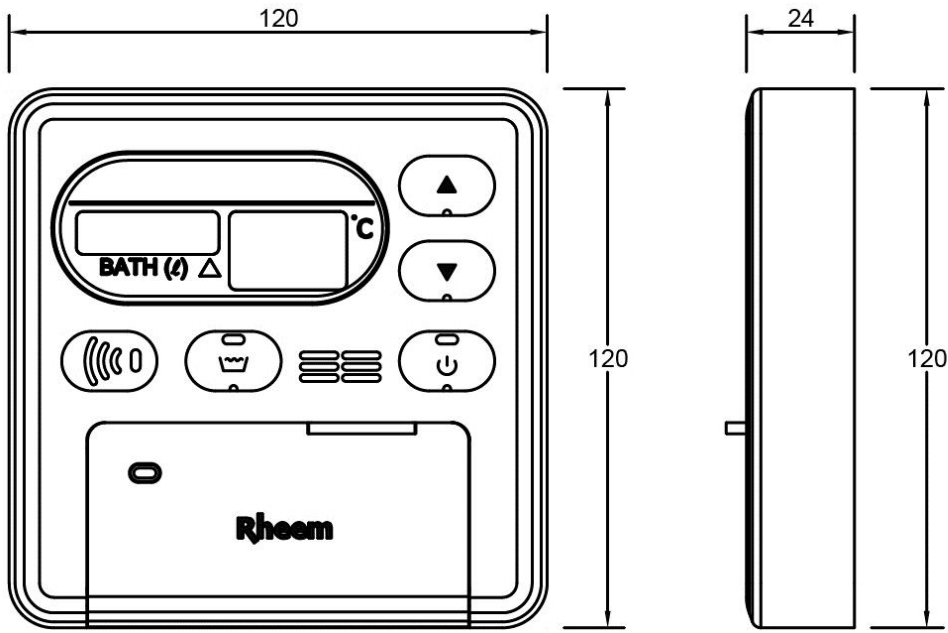

**Deluxe Controller – Cover Closed**

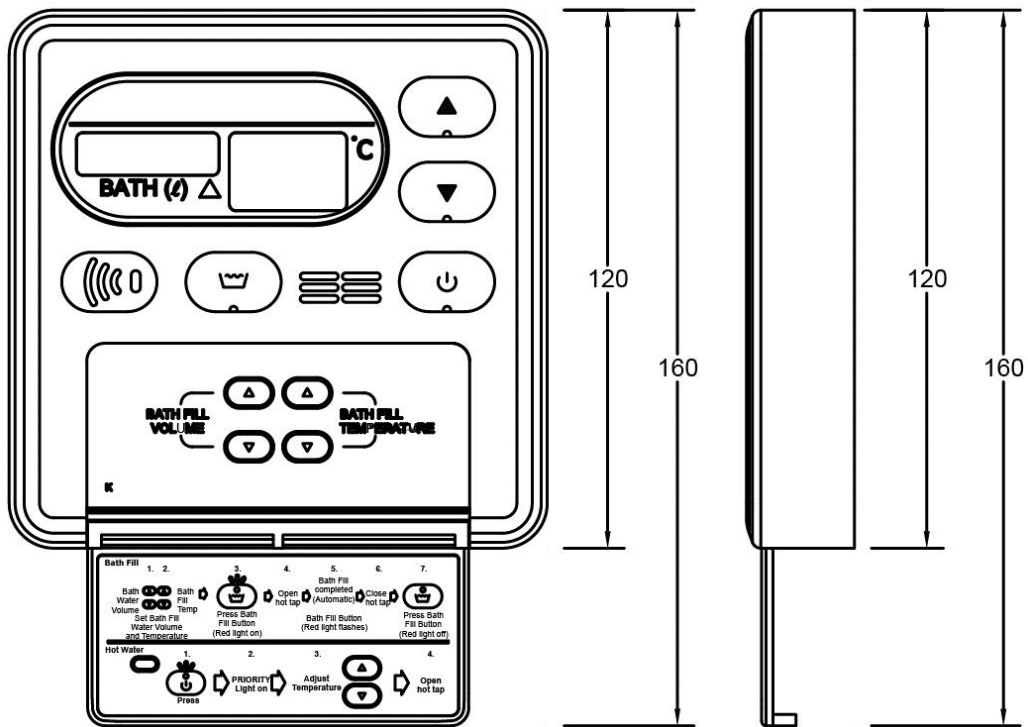

**Deluxe Controller – Cover Open**



TYPICAL INSTALLATION – OUTDOOR LOCATION

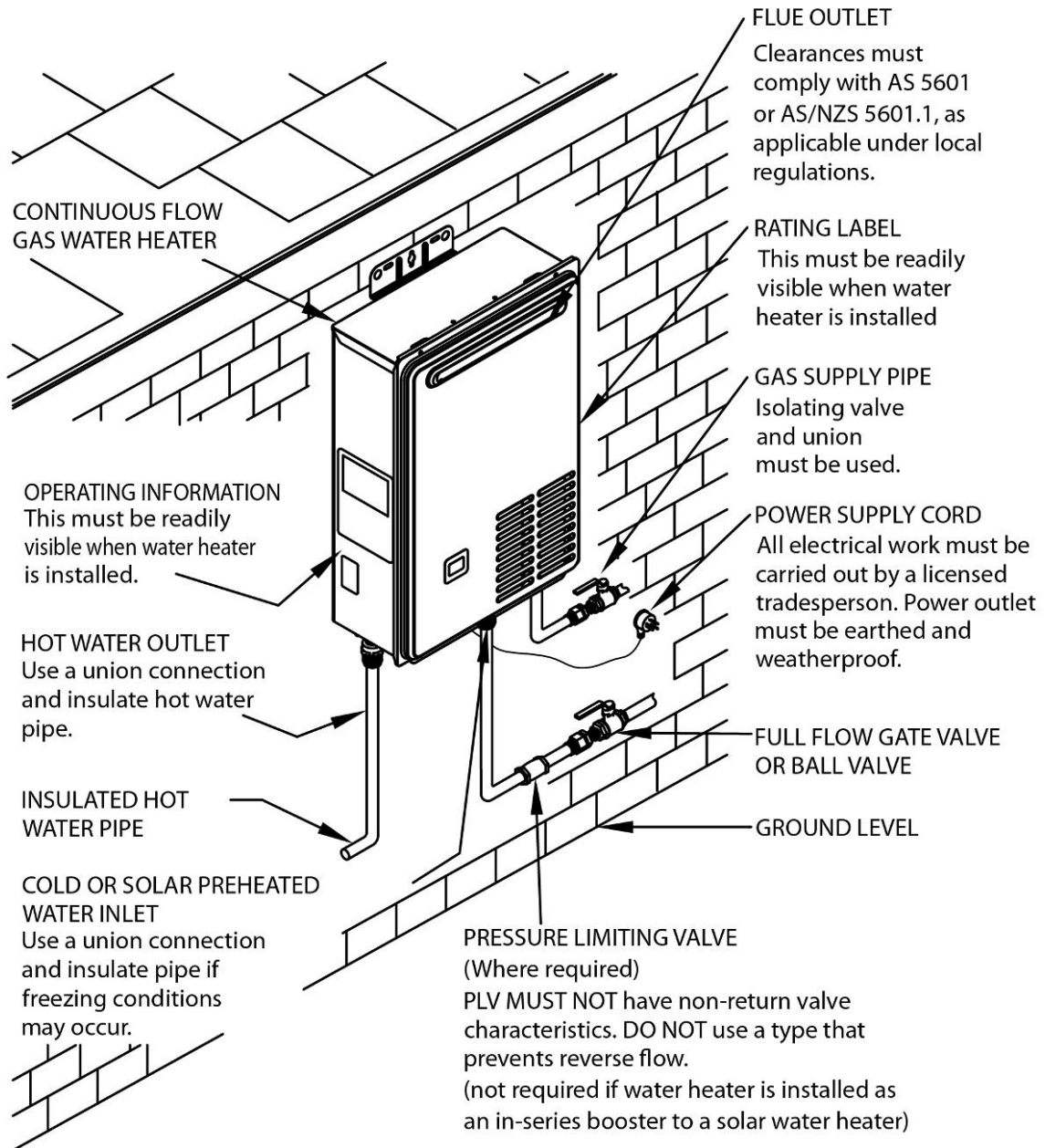

## CONNECTIONS – PLUMBING

All plumbing work must be carried out by a qualified person and in compliance with the Standard AS/NZS 3500.4 and all local codes and regulatory authority requirements.

All gas work must be carried out by a qualified person and in compliance with the Standard AS 5601 or AS/NZS 5601.1, as applicable under local regulations, and all local codes and regulatory authority requirements.

### CONNECTION SIZES

Model	874 612	874 616, 874 E16	874 618	874 620
	876 612	876 616, 876 E16	876 618	876 620
Hot water connection	R 3/4	R 3/4	R 3/4	R 3/4
Cold water connection	R 3/4	R 3/4	R 3/4	R 3/4
Gas inlet	R 3/4	R 3/4	R 3/4	R 3/4

### WATER INLET AND OUTLET

All pipe work must be cleared of foreign matter before connection and purged before attempting to operate the water heater. All olive compression fittings must use brass or copper olives. Use an approved thread sealant such as Teflon tape on all threaded joints.

A full flow gate valve or ball valve must be installed on the cold water line or solar preheat water line to the water heater. **A non-return valve or stop tap must not be installed.** An acceptable arrangement is shown in the diagram. Refer also to “Hot Water Delivery” on page 49 and to “Mains Water Supply” on page 48.

A disconnection union must always be provided at the cold water inlet and hot water outlet on the water heater to allow for disconnection of the water heater.

Insulation used on the cold and hot water lines must extend up to the cold water inlet and hot water outlet of the water heater.

### Notes:

- It is essential all pipe connections be correctly aligned, otherwise component connections within the water heater may be strained and / or components themselves misaligned. It is recommended also, wherever possible, pipe connections be made at the water heater first and final pipe runs be made in soft copper pipe to allow some adjustment for misalignment.
- Use the spanner flats on the water heater fittings and take care to avoid twisting the water inlet and outlet pipes inside the jacket.
- The maximum supply temperature to the water heater when used as an in-series gas booster for a solar water heater is 80°C.

### PIPE SIZES

The pipe sizing for hot water supply systems should be carried out by persons competent to do so, choosing the most suitable pipe size to ensure adequate flow for each individual application. Reference to the technical specifications of the water heater and local regulatory authority requirements must be made.

To achieve true mains pressure operation, the cold water line to the water heater should be the same size or bigger than the hot water line from the water heater.

The minimum recommended cold pipe or solar preheat pipe and hot pipe size is DN20.

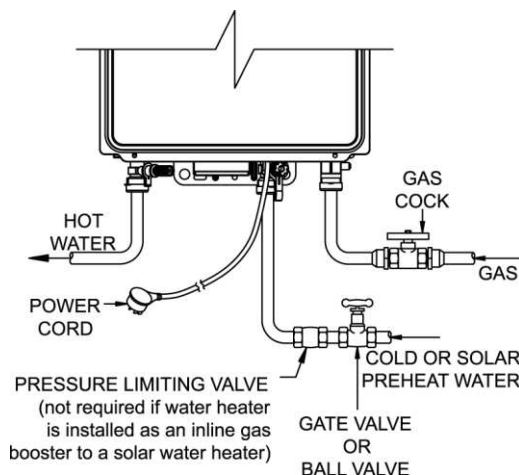

**Gas Water Heater  
Cold (or Solar Preheat) and Hot Water  
and Gas Connection Details**

**IN-SERIES BOOSTER**

The pipe work between the solar storage tank (if one is installed) and the in-series gas booster has a minimum recommended pipe size of DN20, **MUST BE** of copper and be fully insulated with a closed cell type insulation or equivalent in accordance with the requirements of AS/NZS 3500.4.

The insulation must be weatherproof and UV resistant if exposed. The insulation must be fitted up to the connections on both the solar storage tank and the in-series gas booster. A full flow isolation valve must be installed on the water line to the in-series gas booster.

**GAS INLET**

The gas connection is made at the underside of the water heater. The pipe work must be cleared of foreign matter before connection and purged before attempting to operate the water heater. An isolation valve and disconnection union must be installed to allow servicing and removal of the water heater (refer to the [diagram on page 58](#)).

**Note:** Refer to the Gas Installations Standard AS 5601 or AS/NZS 5601.1 for the correct method of sizing the gas supply pipe to the water heater. The pipe size selection must take into account the high gas input of this water heater ([refer to table on page 54](#)) as well as all of the other gas appliances in the premises.

**⚠ Warning:** Always isolate the water heater before pressure testing the gas supply system. Disconnect the water heater after the isolation valve to prevent the risk of serious damage to the gas control. The Rheem warranty does not cover damage of any nature resulting from failure to observe this precaution. Refer to rating label for gas types and pressures.

---

**CONNECTIONS – ELECTRICAL**

---

All electrical work and permanent wiring must be carried out by a qualified person and in accordance with the Wiring Rules AS/NZS 3000 and all local codes and regulatory authority requirements.

**⚠ Warning:** Temperature controllers **must not** be fitted to this water heater (874 series) if it is installed as an in-series gas booster with a solar water heater system because water at a temperature much higher than the controller setting can be delivered. If a solar water heater has been installed to an existing water heater installation, then all controllers **must be** disconnected and removed.

The water heater is supplied with a 1.8 metre lead and plug and requires a weatherproof 240 V 50 Hz general purpose outlet (GPO) to be located within 1.2 metres of the installation. The GPO must be clear of the flue exhaust, draining water, gas supply pipe and water connections.

The power consumption of the water heater is:

Component	Power consumption	Comments
Gas water heater	61 Watts	612 – 620, E16 – Burner on, anti frost device inactive
	138 Watts	612 – Burner on, anti frost device active
	143 Watts	616, E16 – Burner on, anti frost device active
	147 Watts	618 – Burner on, anti frost device active
	151 Watts	620 – Burner on, anti frost device active

The water heater will only operate on a sine wave at 50 Hz. Devices generating a square wave cannot be used to supply power to the water heater.



## EZ-LINK SYSTEM DUAL INSTALLATION

The EZ-Link™ system is designed to electronically control two continuous flow gas water heaters and have them operate as one. One or both water heaters may be in operation, depending upon the hot water demand. The second water heater will only operate when the hot water demand exceeds the capacity of the first water heater to supply.

The EZ-Link system is suitable for installation with Rheem 874 and 876 series 612, 616, E16, 618 and 620 model continuous flow gas water heaters. The Ez-Link Kit PN 290141 is required for the installation.

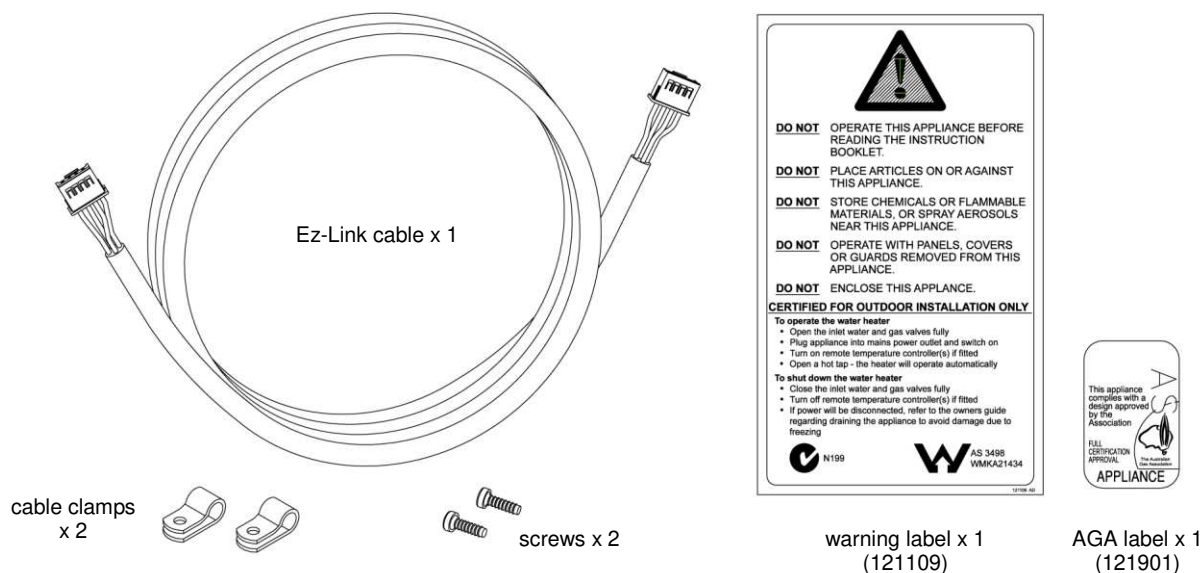

### Ez-Link Kit – PN 290141

#### Notes:

- Only two continuous flow gas water heaters can be installed with an Ez-Link system.
- The Ez-Link system will vary the start up sequence of the two water heaters.
- The two continuous flow water heaters must be of the same model. The performance of two different model water heaters manifolded together cannot be guaranteed.
- Rheem 874 and 876 series 612, 616, E16, 618 and 620 model water heaters do not require a temperature controller to be installed as part of an Ez-link system installation.
- A temperature controller(s) may be installed with the EZ-Link system on an 874 and 876 series 612, 616, E16, 618 or 620 model dual installation. The controller can be either a standard or Deluxe controller.

If the preset outlet temperature of the water heater is set at greater than 60°C, the maximum outlet temperature of the water heater will be limited by the maximum temperature setting of the temperature controller, if one is installed.

- Two 874 series 612, 616, E16, 618 or 620 model water heaters manifolded together with an Ez-Link system installed can be used as an in-series gas booster system to a solar water heater installation so long as a temperature controller is not installed.

**⚠ Warning:** Two continuous flow water heaters manifolded together with an Ez-Link system installed cannot be used as an in-series gas booster system to a solar water heater installation if a temperature controller is installed. Temperature controllers **must not** be fitted to a water heater as part of a solar water heater system because water at a temperature much higher than the controller setting can be delivered.

## DUAL INSTALLATION

The two continuous flow water heaters can be installed side by side with minimal clearance between them. The AGA has approved the installation of two of this model water heater with an exemption from the 300 mm minimum clearance requirements between flue terminals, as stated in AS/NZS 5601, clause 5.13.6.5 and AS/NZS 5601.1, clause 6.9.3.

Install two continuous flow water heaters of the same model in a parallel plumbing arrangement. It is good practice, but not essential, to install the two water heaters in an Equa-Flow® manifold plumbing arrangement. There are basic installation requirements which must be followed:

1. The pipe work must be sized to meet the requirements of both AS/NZS 3500.4 and the application. It is recommended to use minimum DN25 pipe for the cold water line, cold and hot headers and hot water line and DN20 for the cold and hot water branch lines of each water heater.
2. A full flow gate valve or ball valve must be installed on the cold water line to the system. A non-return valve or stop tap must not be installed.
3. A full flow gate valve or ball valve (not a stop tap) should be installed on both the cold water branch and hot water branch of each water heater.
4. An isolation valve must be installed on the gas branch of each water heater.
5. Non-return valves or pressure limiting valves must not be installed on the branch lines to the water heaters.
6. All fittings, valves and branch lines should be matched sets to each of the water heaters.
7. Sufficient space must be left to enable access, servicing or removal of either water heater.

Refer to the '[Typical Two Unit Manifold with Ez-Link Connection](#)' diagram on page 64 for installation and plant layout details.

## LABELS

A warning label (121109) and an AGA approval label (121901) are supplied in the Ez-Link kit. Where the two water heaters are installed close together and the warning label and AGA approval label on the inside face of the right hand water heater cannot be read, it is necessary to adhere the two labels supplied to the right-hand face of the water heater.

1. Place the warning label below the rating label.
2. Place the AGA approval label beside the barcode label.

Refer to the '[Label Positioning](#)' diagram on page 61 for the position of the two labels to be adhered to the water heater.

A second rating label is attached to the inside of the front cover. This can be referenced to determine details of the left hand water heater.

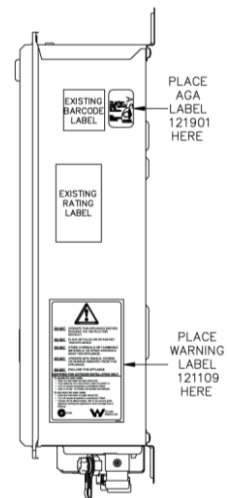

**Label Positioning**

## TEMPERATURE CONTROLLER

A temperature controller may be installed with the EZ-Link system. The controller can be either a standard or Deluxe controller. Rheem 874 and 876 series 612, 616, E16, 618 and 620 model water heaters do not require a temperature controller to be installed as part of an Ez-link system installation.

Connect a temperature controller to one only of the two water heaters. Up to three temperature controllers of the same family can be installed to this water heater. Refer to "[Installation – Controllers](#)" on page 65.

The water heater connected with the temperature controller(s) will become the "master" water heater. The installed temperature controller(s) will control the temperature and functionality of both water heaters. The maximum outlet temperature of the water heaters will be limited by the maximum temperature setting of the temperature controller.

A temperature controller should not be installed if two 874 series 612, 616, E16, 618 or 620 model water heaters have been Ez-Linked together and they are part of a circulated hot water flow and return system in a building. Refer to "[Circulated Hot Water Flow And Return System](#)" on page 51.

**EZ-LINK CABLE CONNECTION**

The references in steps 5 to 8 are to the 'Control Board with Ez-Link Connection' diagram on page 63. To connect the Ez-Link cable to the water heaters:

1. Close any hot taps and ensure the burners on both water heaters are not operating.
2. Switch off the electrical supply at the power outlet to each water heater.
3. Remove the screws holding the front panel to the jacket on each water heater.
4. Gently disengage the front panel and pull forward to remove from each water heater.
5. Connect one end of the EZ-Link cable to the first water heater.
  - Draw the cable through the cable grommet on the underside of the water heater.
  - Plug the cable into the connector marked "E" in the upper right-hand corner of the Control Board (refer to the Control Board diagram).  
The connector will only fit one way.
  - Press until the connector snaps into place.
  - Secure the EZ-Link cable with the clamp and screw provided to the bottom right of the Control Board (refer to the Control Board diagram).

6. Switch DIP SWITCH 4 to the on (up) position on the first water heater (refer to the Control Board diagram).

- If a temperature controller is not installed, then also switch DIP SWITCH 3 to the on (up) position on the first water heater.

7. Connect the other end of the EZ-Link cable to the second water heater.

- Draw the cable through the cable grommet on the underside of the water heater.
- Plug the cable into the connector marked "E" in the upper right-hand corner of the Control Board (refer to the Control Board diagram).  
The connector will only fit one way.
- Press until the connector snaps into place.
- Secure the EZ-Link cable with the clamp and screw provided to the bottom right of the Control Board (refer to the Control Board diagram).

8. Switch DIP SWITCH 4 to the on (up) position on the second water heater (refer to the Control Board diagram).

9. Refit the front panel and screws to each water heater.
10. Check the main gas isolation valve and the isolation valves at the gas inlet to each water heater are fully open.
11. Switch on the electrical supply at the power outlet to the water heater.
12. Turn on the controller by pressing the on / off (⏻) button, if one is installed.

The on / off operating light and the priority light will both glow.

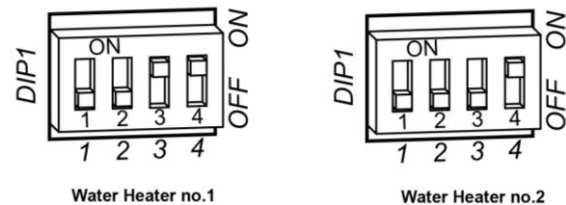

**dip switch settings  
without temperature controller**

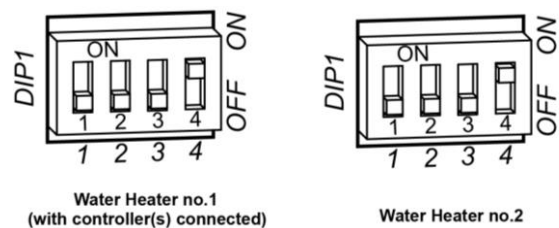

**dip switch settings  
with temperature controller connected**

## 13. Open a hot tap.

The first water heater and depending upon the flow from the hot tap, the second water heater will operate automatically.

## 14. Increase the hot water flow by turning on an additional hot tap(s).

Check to ensure the flow from each connected hot tap is sufficient to operate both water heaters.

The minimum operating flow rate for each water heater is 2.5 litres per minute.

## 15. Turn off the hot taps.

Refer to [“Commissioning”](#) on page 72 for details on completing the installation.

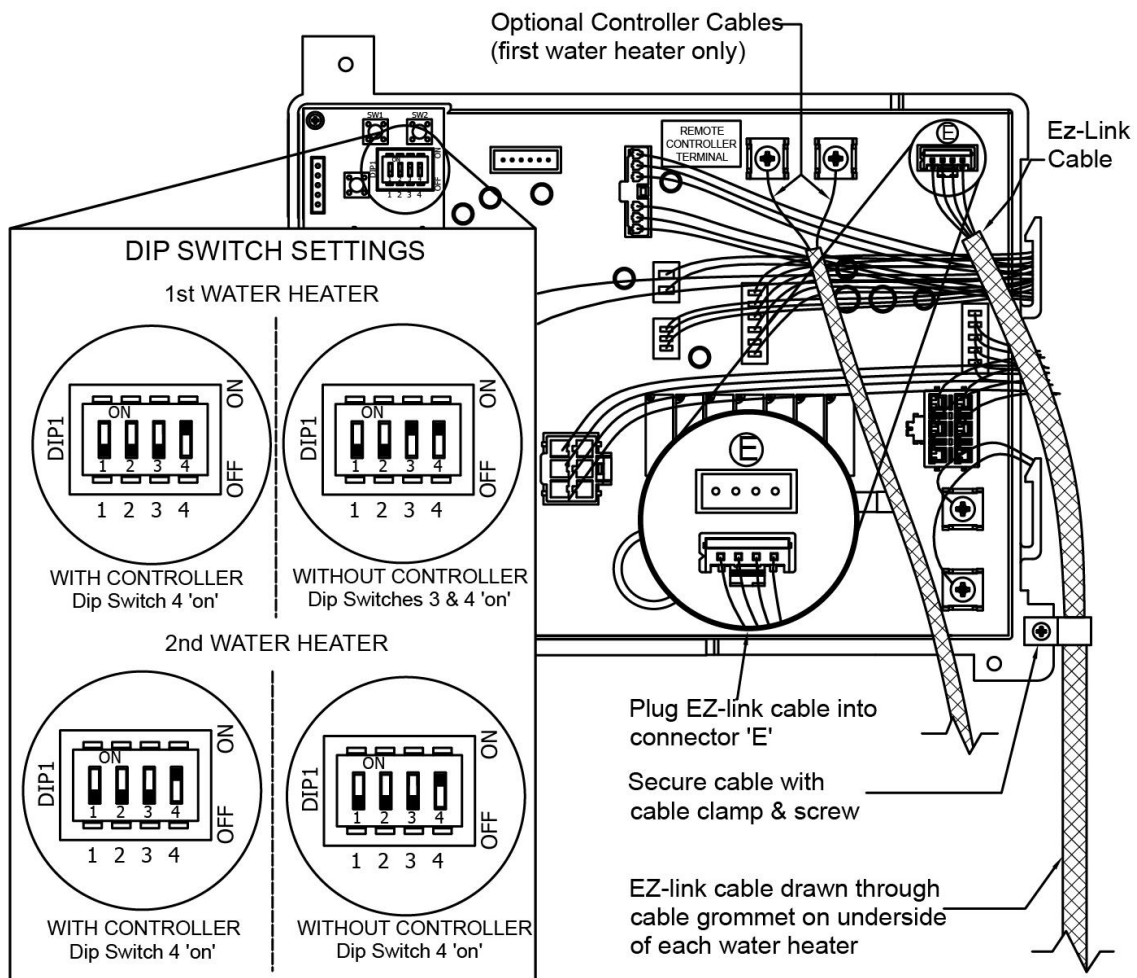

**Control Board with Ez-Link Connection**  
874 and 876 series 612, 616, E16, 618 and 620 models

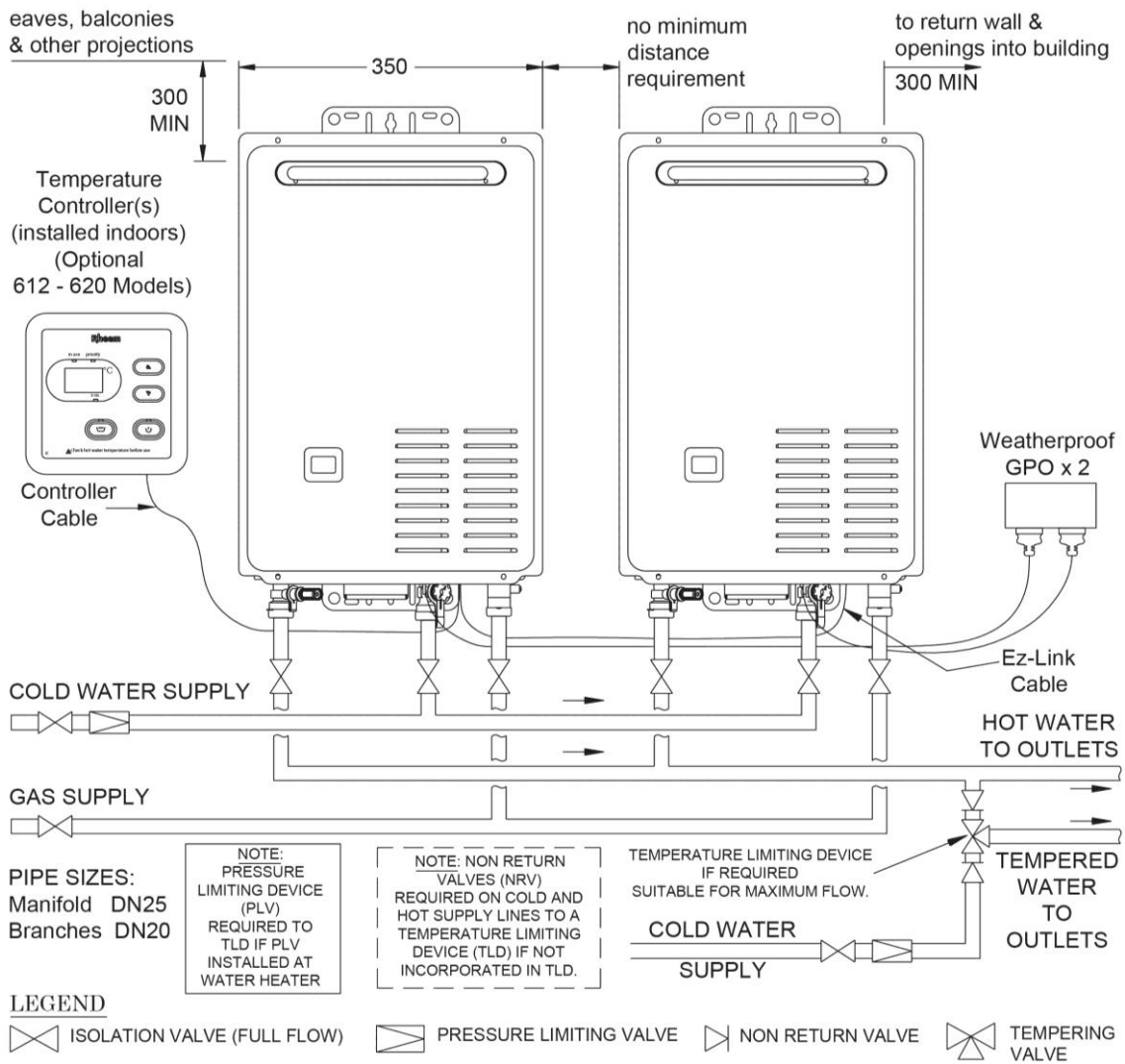

**Typical Two Unit Manifold with Ez-Link Connection  
874 and 876 series 612, 616, E16, 618 and 620 models**



---

## INSTALLATION – CONTROLLERS

---

### CONTROLLERS

The Rheem 874 and 876 series can be installed with Rheem controllers to enable the user to control the temperature of the delivered water from the outlet of the water heater.

There are two families of Rheem controllers suitable for installation with this water heater. These are the standard controllers and the Deluxe controllers.

#### Standard Controllers

There are three types of standard controller. They are the Kitchen controller (Rheem PN 299853), Bathroom1 controller (Rheem PN 299854) and the Bathroom2 controller (Rheem PN 299855).

The standard controllers are suitable for use on all 874 and 876 series models.

The standard controllers are identified by a 'K' (Kitchen controller), 'B1' (Bathroom1 controller) or 'B2' (Bathroom2 controller) located on the front bottom left hand corner of the standard controller.

#### Deluxe Controllers

There are three types of Deluxe controller. They are the Kitchen Deluxe controller (Rheem PN 299861), Bathroom1 Deluxe controller (Rheem PN 299862) and the Bathroom2 Deluxe controller (Rheem PN 299863).

The Deluxe controllers are suitable for use on all 874 and 876 series models.

The Deluxe controllers are identified by a 'K' (Kitchen Deluxe controller), 'B1' (Bathroom1 Deluxe controller) or 'B2' (Bathroom2 Deluxe controller), located under the front panel, to the bottom left hand corner adjacent to the BATH FILL VOLUME label.

The standard and Deluxe controllers are designed to be hard wired into the water heater using either the Kitchen controller cable (Rheem PN 299856) or the Bathroom controller cable (Rheem PN 299857).

#### Notes:

- Where more than one controller is installed, the second or third controller must be of the same family.
- A standard controller can only be installed with another standard controller(s) and a Deluxe controller can only be installed with another Deluxe controller(s). A standard controller(s) and a Deluxe controller(s) cannot be connected to the same water heater.
- One, two or three controllers can be installed. Only one of each type of controller can be connected to the water heater. Therefore, a maximum of three controllers only can be connected to each water heater.
- A Bathroom2 controller can only be installed if a Bathroom1 controller is installed and a Bathroom2 Deluxe controller can only be installed if a Bathroom1 Deluxe controller is installed.
- An additional Kitchen controller cable or Bathroom controller cable can be used if an extension of the cable length is required.

It will be necessary to cut an opposite end off both cables to be installed in order to wire them together. Alternatively, the cables may be extended using two-core flex with a minimum cross-sectional area of 0.5 mm<sup>2</sup>.

- Other manufacturers' controllers are not suitable to and cannot be installed with this water heater.

**⚠ Warning:** Temperature controllers **must not** be fitted to this water heater (874 series) if it is installed as an in-series gas booster with a solar water heater system because water at a temperature much higher than the controller setting can be delivered. If a solar water heater has been installed to an existing water heater installation, then all controllers **must be** disconnected and removed.

**Location – The controllers must be installed in dry, shaded and clean locations.**

**Do not install the controllers:**

- Near a heat source, such as a cook top, stove or oven. Heat, steam and smoke will interfere with the electronic components of the controllers.
- In direct sunlight.
- In or near a wet area. The controllers are not waterproof. Water may damage the controllers.
- Outdoors. The controllers are not weatherproof.

**KITCHEN CONTROLLER**

The standard Kitchen controller (Rheem PN 299853) or Kitchen Deluxe controller (Rheem PN 299861) is to be installed in the kitchen or laundry only. It has a minimum temperature setting of 37°C and a maximum temperature setting of:

- 874 series                      60°C
- 876 series                      48°C

Choose a suitable location for the Kitchen controller, away from water, heat and sunlight.

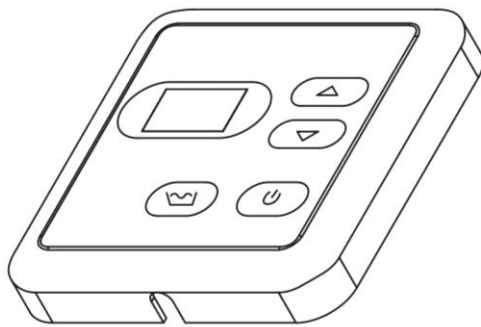

Kitchen controller (standard)

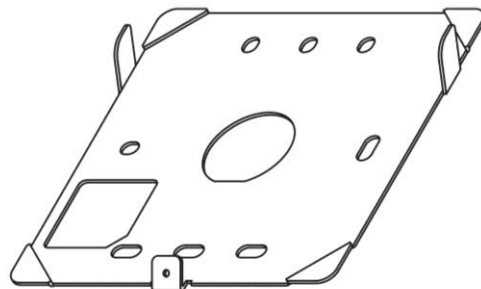

base plate

screw x 2   controller screw

**Kitchen Controller (Standard) Components**

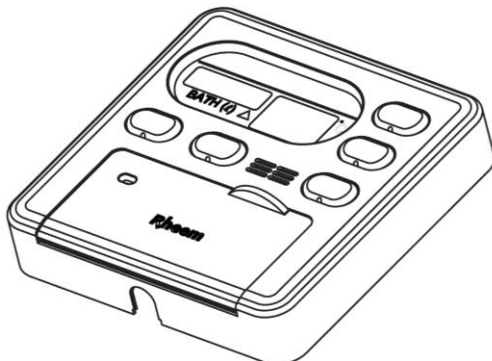

Kitchen Deluxe controller

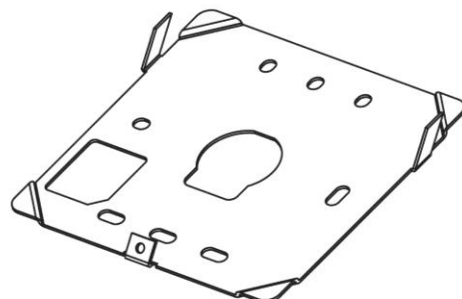

base plate

screw x 2    controller screw

**Kitchen Deluxe Controller Components**

**Wiring installation:**

1. Penetrate the wall with a 30-35 mm hole at the controller location.
2. Install the Kitchen controller cable between the location of the controller and the water heater.
3. Remove the base plate from the controller.
4. Draw the cable through the central hole in the base plate.
5. Fix the base plate to the wall using suitable screws and wall anchors.  
Ensure the projections in the base plate are pointing upwards.
6. Connect the cable to the two terminals on the back of the controller (connections are not polarity sensitive).  
Ensure the connecting screws are seated tightly.
7. Place the controller over the base plate.  
Ensure the projections in the base plate fit into the housings in the controller.
8. Fix the controller to the base plate at the bottom of the controller, using the controller screw provided.
9. Proceed to [“Connecting the Controller\(s\) to the Water Heater”](#) on page 71.

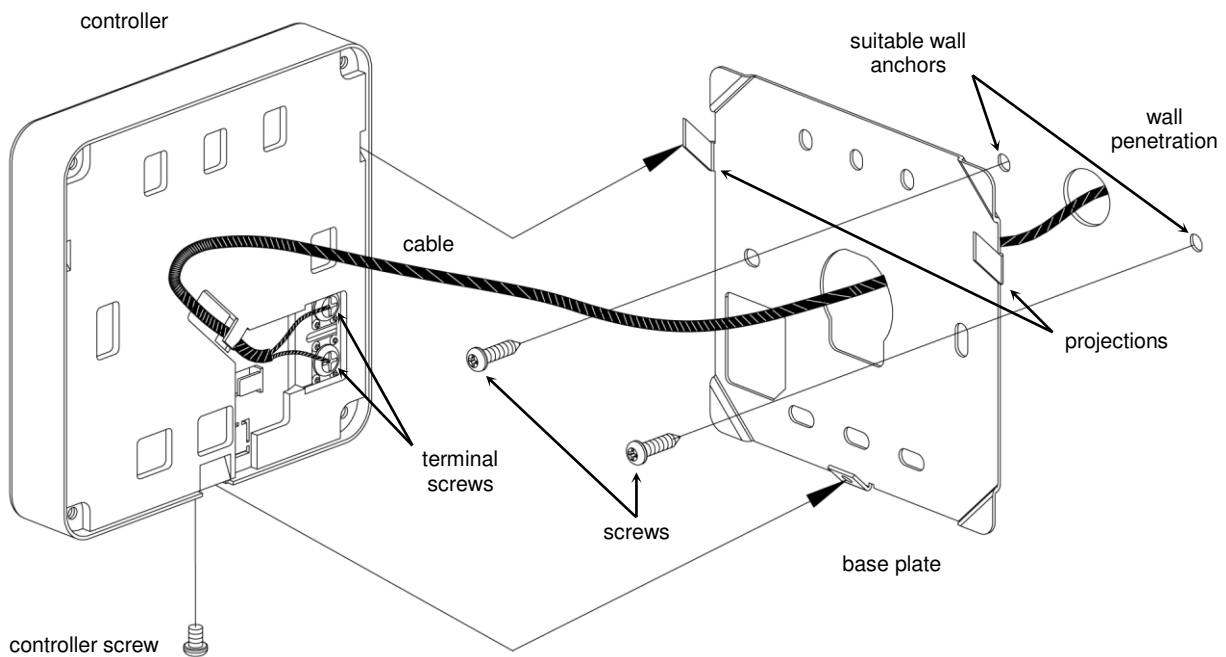

**Kitchen Controller (Standard and Deluxe) Installation  
Concealed Cable**

If it is necessary to have an exposed wiring installation, follow this procedure omitting Steps 1 and 4, and make an opening in the thin section in the underside of the controller to accommodate the cable (as shown in the diagram), prior to Step 6.

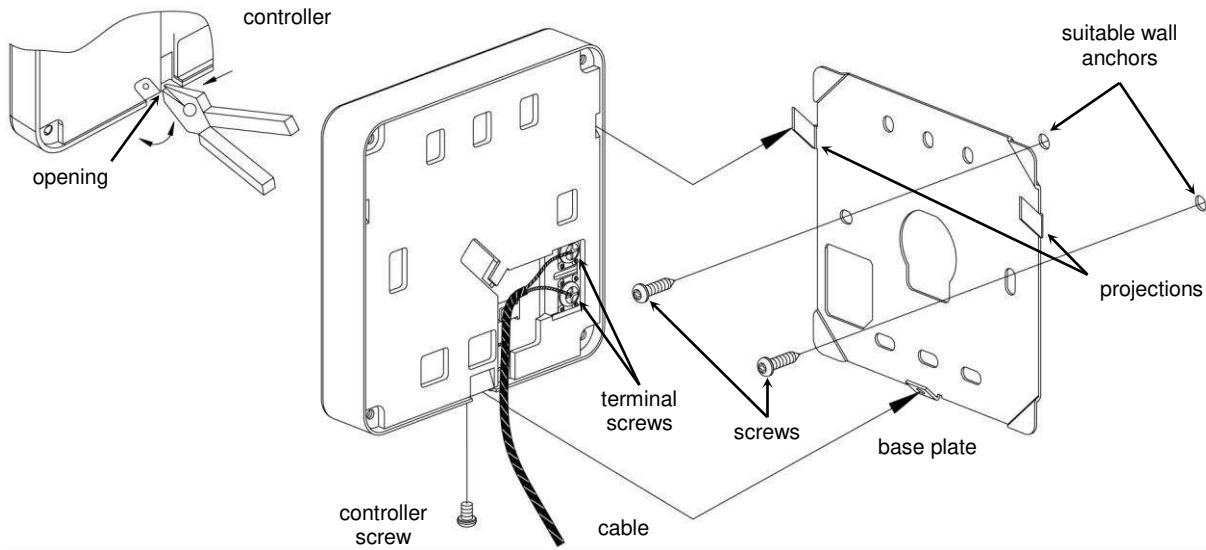

**Kitchen Controller (Standard and Deluxe) Installation  
Exposed Cable**



**BATHROOM1 AND BATHROOM2 CONTROLLERS**

If only one Bathroom controller is to be installed, the standard Bathroom1 Controller (Rheem PN 299854) or the Bathroom1 Deluxe controller (Rheem PN 299862) must be used. If two Bathroom controllers are to be installed, one must be a standard Bathroom1 controller and the other must be a standard Bathroom2 controller (Rheem PN 299855) or one must be a Bathroom1 Deluxe controller and the other must be a Bathroom2 Deluxe controller (Rheem PN 299863).

They have a minimum temperature setting of 37°C and a maximum temperature setting of:

- 874 series                      50°C
- 876 series                      48°C

The method of installation for the standard Bathroom1 and Bathroom2 controllers and the Bathroom1 Deluxe and Bathroom2 Deluxe controllers is identical.

Choose a suitable location for each Bathroom controller, away from water, heat, and sunlight. The Bathroom controllers are supplied with a 250 mm length of wire with connectors to mate with the Bathroom controller cable.

**Notes:**

- It is not recommended to have exposed wiring in a bathroom.
- Do not apply sealant to the controller cable.

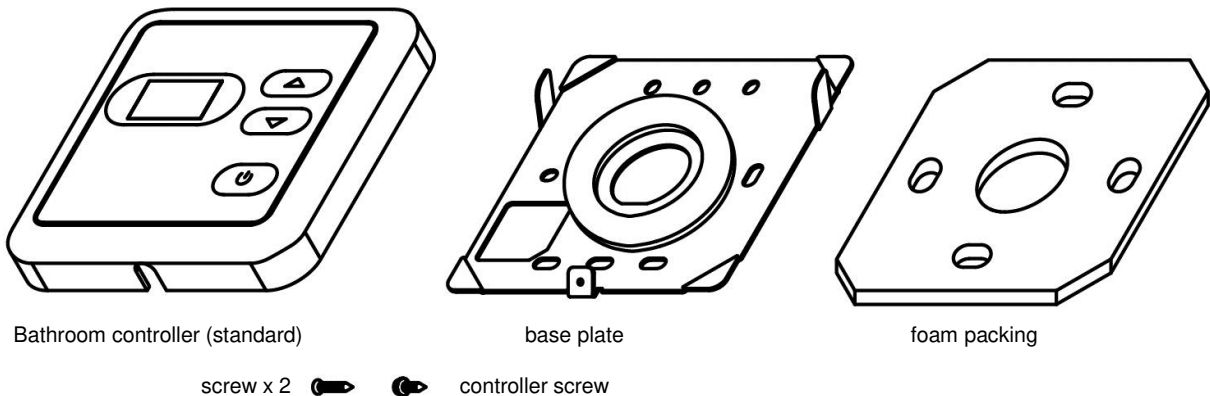

**Bathroom1 and Bathroom2 Controller Components**

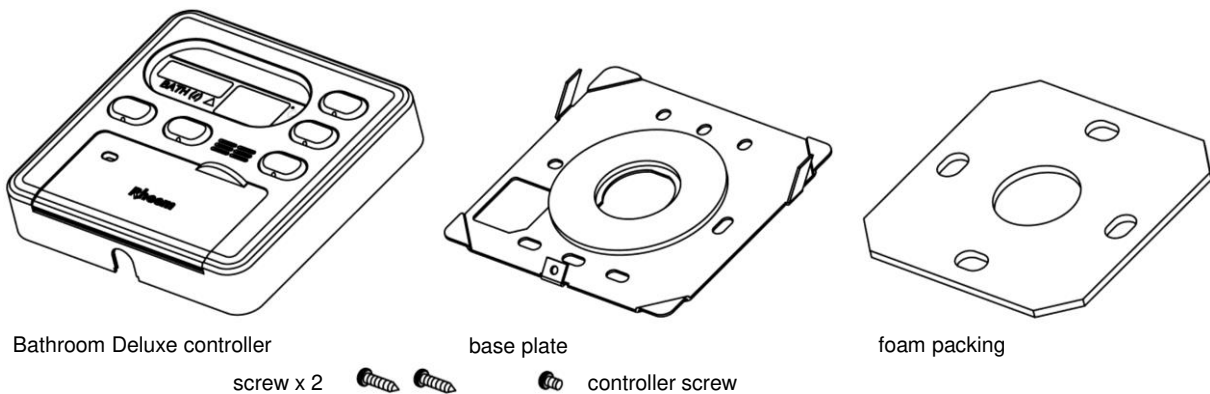

**Bathroom1 Deluxe and Bathroom2 Deluxe Controller Components**



**Wiring installation:**

1. Penetrate the wall with a 30-35 mm hole at the controller location.
2. Install the supplied cable between the location of the controller and the water heater.
3. Remove the base plate from the controller.
4. Peel off one side of the adhesive paper from the foam packing and adhere to the back face of the base plate. This is the side without the projections.
5. Peel off the remaining adhesive paper from the foam packing.
6. Draw the cable through the central hole in the base plate.
7. Fix the base plate to the wall using suitable screws and wall anchors.  
Ensure the projections in the base plate are pointing upwards.
8. Plug the controller wire into the Bathroom controller cable.
9. Place the controller over the base plate.  
Ensure the projections in the base plate fit into the housings in the controller.
10. Fix the controller to the base plate at the bottom of the controller, using the screw provided.
11. Proceed to [“Connecting the Controller\(s\) to the Water Heater”](#) on page 71.

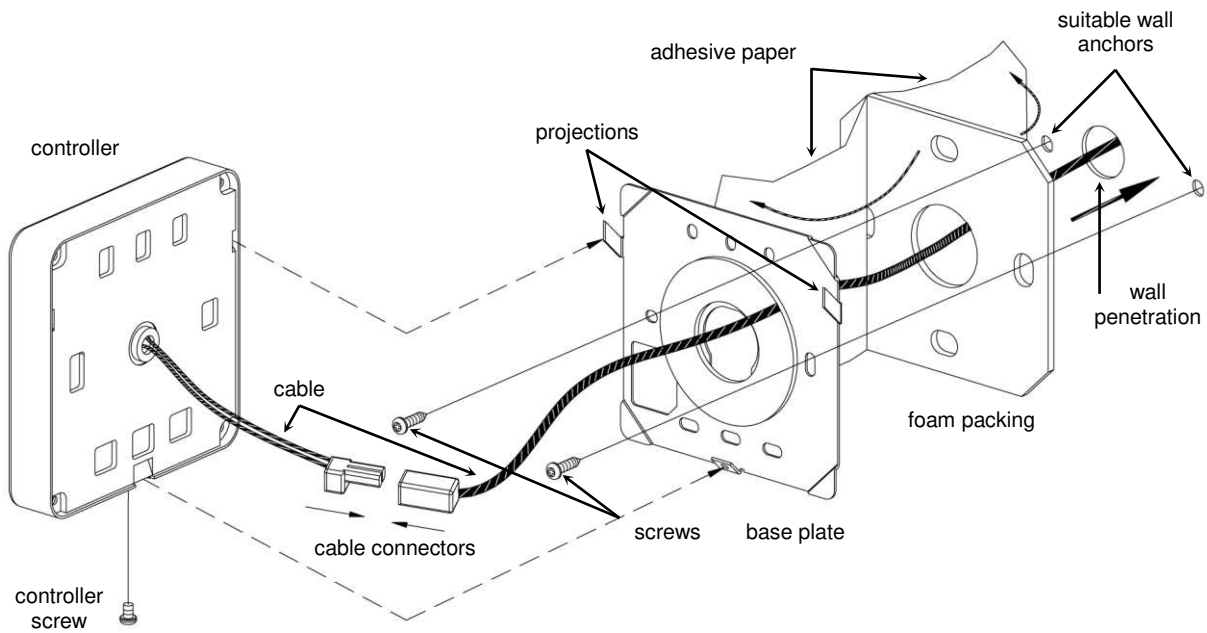

**Bathroom Controller (Standard and Deluxe) Installation**

### CONNECTING THE CONTROLLER(S) TO THE WATER HEATER

To connect the controller(s) to the water heater:

1. Ensure the electrical supply to the water heater is switched off.
2. Unscrew and gently remove the front panel from the water heater.
3. Draw the cable(s) through the cable grommet on the underside of the water heater.
4. Connect a cable lug from each cable to each of the remote controller terminals. Each cable has two cable lugs.

The two remote controller terminals are adjacent to each other and located at the top right of the printed circuit board (PCB), to the right of the label marked 'REMOTE CONTROLLER TERMINAL'.

Ensure the terminal screws are seated firmly and there are no excess wire loops inside of the front panel.

- The cable connections are non-polarised.
- Up to three cable lugs, one from each type of controller, can be connected to each remote controller terminal.

**⚠ Warning:** Do not confuse the remote controller terminals with the two 100 V terminals under the label flap marked 'DANGER 100 V DISCONNECT POWER' at the bottom right of the PCB.

5. Refit the front panel and screws to the water heater.
6. Switch on the electrical supply to the water heater.

Upon completion of the installation of the controllers, it is necessary to test their operation through the complete range of functions (refer to ["Temperature Control"](#) on pages 11 to 40).

Upon completion and testing of the installation, explain to the householder the functions and operation of the controllers and the water heater.

If it is necessary to turn off the water heater on completion of the installation, such as on a building site or where the premises is vacant, follow the procedure ["To Turn Off the Water Heater"](#) on page 81.

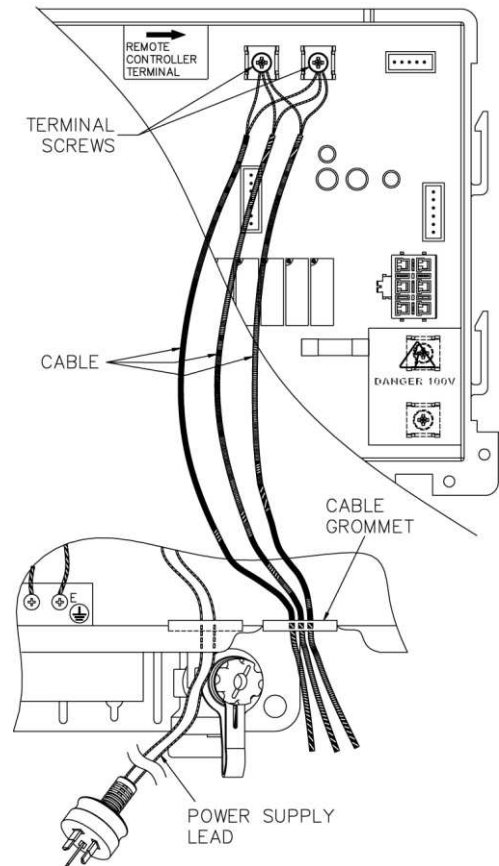

---

## COMMISSIONING

---

All water heaters are tested and adjusted before dispatch from the factory, however further adjustments may become necessary because of local conditions.

### TO TURN ON THE WATER HEATER

- Open all of the hot taps in the house (don't forget the shower).
- Open the cold water isolation valve fully at the inlet to the water heater.  
Air will be forced out of the taps.
- Close each tap as water flows freely from it.
- Check the pipe work for leaks.
- Open the gas isolation valve fully.
- Check the gas pipe work for leaks.
- Plug in the water heater at the power outlet and switch on the electrical supply.
- Turn on a controller, if one is fitted, by pressing the on / off (⏻) button.  
The on / off operating light and the priority light will both glow.
- Open a hot tap.  
The water heater will operate automatically.
- Check to ensure the flow from each connected hot tap is sufficient to operate the water heater.  
The minimum operating flow rate for all models is 2.5 litres per minute.
- Check and if required adjust the preset outlet temperature setting of the water heater.  
Refer to "[Preset Outlet Temperature Setting](#)" on page 77.
- Check and if required adjust the outlet compensation temperature adjustment on an 876 series water heater.  
Refer to "[Outlet Compensation Temperature Adjustment – 876 Series](#)" on page 79.

The automatic water governor incorporated in the water heater is not adjustable.

To complete the installation, it is necessary to check the gas supply pressure at the inlet to the water heater (refer to "[Gas Inlet Pressure](#)" on page 72), the minimum test point pressure and the maximum test point pressure (refer to "[Burner Gas Pressure](#)" on page 74).

Upon completion and testing of the installation, ensure the controller(s) is turned off (if fitted). Explain to the householder or a responsible officer the functions and operation of the water heater and the controllers (if fitted).

**⚠ Warning:** Upon completion of the installation and commissioning of the water heater, leave this guide with the householder or a responsible officer. **DO NOT** leave this guide inside of the cover of the water heater, as it may interfere with the safe operation of the water heater or ignite when the water heater is turned on.

### GAS INLET PRESSURE

**IMPORTANT - CHECK** the gas supply pressure at the inlet to the water heater with the water heater and all other gas burning appliances in the premises operating (burners alight). The minimum gas supply pressure is:

Natural Gas	1.13 kPa	Propane	2.75 kPa
-------------	----------	---------	----------

If this minimum cannot be achieved, it may indicate the meter or the gas line to the water heater is undersized. It is important to ensure that an adequate gas supply pressure is available to the water heater when other gas burning appliances, on the same gas supply, are operating.

### Gas Inlet Test Point Pressure

To check the gas inlet pressure:

1. Close any hot taps and ensure the burners are not operating.
2. Close the gas isolation valve at the gas inlet to the water heater.
3. Locate the gas inlet test point on the gas connection to the water heater.
  - Remove the test point screw and washer from the test point orifice.
  - Connect the manometer.
4. Open the gas isolation valve fully at the gas inlet to the water heater.
5. Observe the gas pressure reading on the manometer.

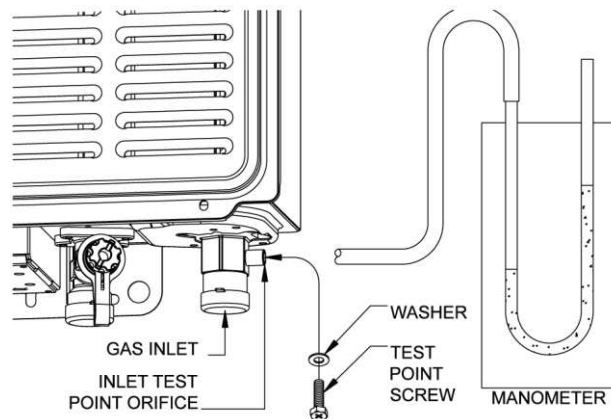

If the manometer reading is between the minimum and maximum gas pressure ratings on the rating label, no adjustment is required.

If the manometer reading is below the minimum gas pressure rating on the rating label, then either the gas pipe to the water heater is undersized and needs to be rectified or adjustment is required at the gas regulator.

If the manometer reading is above the maximum gas pressure ratings on the rating label, then adjustment is required at the gas regulator.

6. Switch on the electrical supply at the power outlet to the water heater if it is not already switched on and turn on a controller, if one is fitted, by pressing the on / off (⏻) button.
7. Open a hot tap fully and ensure the burners are fully ignited.
 

It may be necessary to open a second tap.
8. Turn on all other gas burning appliances in the house which are on the same gas supply.
9. Observe the gas pressure reading on the manometer.

If the manometer reading is between the minimum and maximum gas pressure ratings on the rating label, no adjustment is required.

If the manometer reading is below the minimum gas pressure rating on the rating label, then either the gas pipe to the water heater is undersized and needs to be rectified or adjustment is required at the gas regulator.

If the manometer reading is above the maximum gas pressure ratings on the rating label, then adjustment is required at the gas regulator.

10. Turn off the other gas burning appliances in the house.
11. If an adjustment was made during Step 9, repeat this procedure from Step 5.
12. Close the hot tap(s).
13. Close the gas isolation valve at the inlet to the water heater.
14. Remove the manometer and refit and tighten the test point screw and washer.
15. Open the gas isolation valve fully at the gas inlet to the water heater.
16. Open a hot tap again so the burners ignite.
17. Test for gas leaks.
18. Close the hot tap.

**BURNER GAS PRESSURE**

It is necessary to check the burner gas pressure at both the minimum and maximum operational settings. To check and if necessary adjust the operational gas pressures, the electrical supply to the water heater must be switched on, the burners ignited and hot water must be flowing from a hot tap.

**⚠ Warning:** The removal of the front panel will expose 240 volt wiring. Take care not to touch wiring terminals.

**Note:** If an 874 series model is installed as an in-series gas booster for a solar water heater, then during this procedure the temperature of the water entering the in-series gas booster must be below 58°C. Otherwise the gas burners will not ignite and the operational gas pressures cannot be measured.

A controller is required to be connected to the water heater as part of the procedure to check and if necessary adjust the minimum and maximum test point gas pressures. The minimum and maximum test point gas pressure readings will be displayed on the controller. The controller can be either a standard or Deluxe controller of either a Kitchen or Bathroom1 type and connects to the water heater using either a Kitchen controller cable or a Bathroom controller cable (refer to “[Controllers](#)” on page 65).

**Minimum test point gas pressure**

Refer to the rating label on the water heater for the minimum test point gas pressure.

1. Close any hot taps and ensure the burners are not operating.
2. Turn off the controller(s), if one is fitted, by pressing the on / off (⏻) button and switch off the electrical supply at the power outlet to the water heater.
3. Remove the screws holding the front panel to the jacket.
4. Gently disengage the front panel and pull forward to remove from the water heater.
5. Locate the burner pressure test point on the main burner manifold
  - Remove the test point screw and washer from the test point orifice.
  - Connect the manometer.
6. Connect a controller to the water heater (refer to “[Connecting the Controller\(s\) to the Water Heater](#)” on page 71).
 

**Note:** If one or more controllers have been installed in the premises and connected to the water heater as part of the installation, disconnect their cables from the remote terminal screws on the water heater for this procedure.
7. Switch on the electrical supply at the power outlet to the water heater.
8. Turn on the controller by pressing the on / off (⏻) button.  
The priority light and the on / off operating light will both glow.
9. Open the gas isolation valve fully at the gas inlet to the water heater, if not already open.
10. Open a hot tap slowly until the burners ignite.

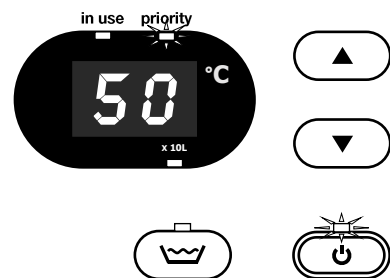
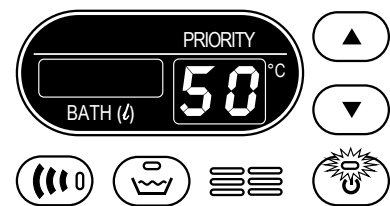
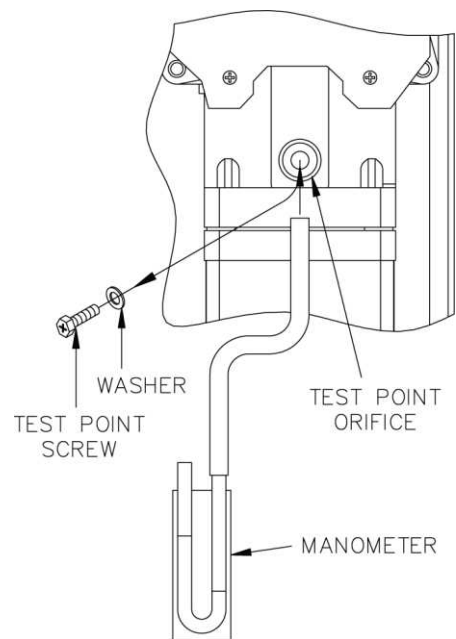

11. Press and hold down the MIN button (“1L” is shown on the controller display), and observe the reading on the manometer.

The red LED will glow and remain solid.

12. Release the MIN button.

The red LED goes out.

If the manometer reading observed in step 11 agrees with the rating label, no further adjustment is required.

13. To adjust, press and hold down the adjuster button (“LH” is shown on the controller display).

The red LED will glow and remain solid.

**Note:** The adjuster button must be held down continuously through steps 13 to 15.

14. Press the MIN button and observe the reading on the manometer.

**Note:** While the MIN button is pressed, the gas pressure will at first increase then decrease, cycling between an upper gas pressure limit (39 on the controller display) and a lower gas pressure limit (01 on the controller display).

15. Release the MIN button when the reading on the manometer agrees with the rating label.

16. Release the adjuster button.

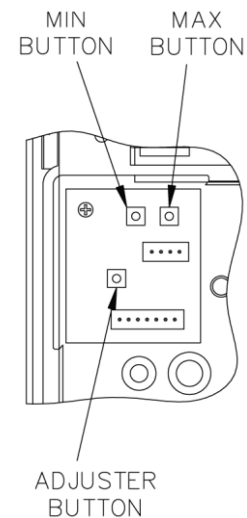

#### Notes:

- If the burners extinguish and / or an error code starts to flash on the controller display:
  - release the MIN and adjuster buttons
  - close the hot tap
  - clear the error code (refer to [“Clearing Error Code”](#) on page 76)
  - recommence the procedure from Step 10.
- If the adjuster button is released before Step 15, clear any error code (if displayed) and recommence the procedure from Step 10.

### Maximum test point gas pressure

Refer to the rating label on the water heater for the maximum test point gas pressure.

Follow Steps 10 to 16 of the [“Minimum test point gas pressure”](#) procedure on page 74, but open the hot tap fully and use the MAX button instead of the MIN button. It may be necessary to open two or three hot taps fully, depending upon the model of water heater and the incoming cold water temperature.

**Note:** In Step 11, “3H” (12 – 20 models) will be shown on the controller display.

After setting the minimum and maximum test point gas pressures:

- Close the hot tap.
- Remove the manometer and refit and tighten the test point screw.
- Open a hot tap again so the burners ignite.
- Test for gas leaks.
- Close the hot tap.
- Turn off the controller by pressing the on / off (⏻) button.
- Switch off the electrical supply at the power outlet to the water heater
- Disconnect the controller cable from the remote terminal screws.
- Reconnect the cables from the controllers (if they have been installed) in the premises to the remote terminal screws (refer to [“Connecting the Controller\(s\) to the Water Heater”](#) on page 71).
- Refit the front panel and screws to the water heater.

### Clearing Error Code

If an error code does appear on the LED display during the commissioning process, it will be necessary to clear the error in order to complete the installation.

To clear an error code:

- turn off the controller by pressing the on / off (⏻) button
- switch off the electrical supply at the power outlet to the water heater
- check the gas isolation valve at the gas inlet to the water heater is fully open
- wait five (5) minutes
- switch on the electrical supply at the power outlet to the water heater
- turn on the controller by pressing the on / off (⏻) button

**PRESET OUTLET TEMPERATURE SETTING**

The factory preset outlet temperature setting of the water heater is:

- 874 series                      60°C
- 876 series                      48°C

If a temperature controller is connected to the water heater, this will override the preset outlet temperature setting and the maximum temperature setting will be:

Maximum Outlet Temperature	874 series	876 series
Kitchen controller connected	60°C	48°C
Bathroom controller only connected	50°C	48°C

It is usually not necessary to adjust the factory preset outlet temperature setting of the water heater, unless the customer has a particular requirement for this to be done or it is to be installed as an in-series gas booster to a solar water heater.

Refer to [“To Check or Adjust the Preset Outlet Temperature Setting”](#) on page 78 to check or if required to adjust the preset outlet temperature setting of the water heater.

**In-series gas booster for a Solar Water Heater**

**Note:** AS 3498 requires that a water heater provides the means to inhibit the growth of Legionella bacteria in potable water. When this water heater is used as an in-series booster for a solar water heater it can satisfy this AS 3498 requirement provided it is energised, the booster preset outlet temperature setting is 70°C, and that a remote temperature controller is not used.

It will be necessary to check and if required to adjust the preset outlet temperature setting of the continuous flow water heater when:

- it is installed as an in-series gas booster to a solar water heater
- it is an existing continuous flow water heater and a solar water heater is then installed.

**Notes:**

- Consideration must be given to the delivery temperature to any ablution and public areas such as a bathroom, ensuite or public amenities. Refer to [“Hot Water Delivery”](#) on page 49 and to [“Schematics of Two Temperature Zones Using A Temperature Limiting Device”](#) on page 50.
- The 876 series water heater, marked “THIS APPLIANCE DELIVERS WATER NOT EXCEEDING 50°C IN ACCORDANCE WITH AS 3498” on the front panel, **must not** be installed as an in-series gas booster to a solar water heater, as water temperature greater than 50°C can be delivered from the water heater contravening its compliance to AS 3498.

**TO CHECK OR ADJUST THE PRESET OUTLET TEMPERATURE SETTING**

The temperature setting will be displayed by a series of flashes from the red LED, with a three (3) second pause between each series of flashes. The preset outlet temperature settings and series of flashes are:

- 874 series                                55°C (1 flash), 60°C (2 flashes), 70°C (3 flashes)
- 876 series                                43°C (1 flash), 45°C (2 flashes), 48°C (3 flashes)

It is necessary to have the electrical supply to the water heater switched on during stages of checking or adjusting the preset outlet temperature setting procedure.

**⚠ Warning:** The removal of the front panel will expose 240 volt wiring. Take care not to touch wiring terminals. The adjustment must be carried out by a qualified person.

**⚠ Warning:** This procedure will involve the adjustment of dip switches. Adjustment of a dip switch should only be made with an insulated tool.

To check or adjust the preset outlet temperature setting:

1. Switch off the electrical supply at the power outlet to the water heater.
2. Remove the screws holding the front panel to the jacket.
3. Gently disengage the front panel and pull forward to remove from the water heater.
4. Close the cold water isolation valve at the inlet to the water heater.
5. Switch on the electrical supply at the power outlet to the water heater.

**Note:** Wait five (5) seconds for the electronic system to initialise.

6. Switch DIP SWITCHES 3 and 4 to the on (up) position on the I.C. Board.

The red LED will commence a series of flashes, with three (3) seconds between each series.

If the red LED is flashing the correct number of flashes for the desired preset temperature, then proceed to step 8, as no further adjustment is necessary.

7. Press the MAX button to increase or the MIN button to decrease the preset outlet temperature setting.

Each press of the MAX or MIN button will increase or decrease the preset temperature by one increment.

The MAX and MIN buttons are located above the DIP switches.

**874 series**

The increments are 55°C (1 flash), 60°C (2 flashes), 70°C (3 flashes).

**876 series**

The increments are 43°C (1 flash), 45°C (2 flashes), 48°C (3 flashes).

8. Switch DIP SWITCHES 3 and 4 to the off (down) position.

The red LED will go out.

**Note:** Wait five (5) seconds for the setting to be saved. The preset outlet temperature setting is now set.

9. Switch off the electrical supply at the power outlet to the water heater.
10. Refit the front panel and screws to the water heater.
11. Open the cold water isolation valve fully at the inlet to the water heater.
12. Switch on the electrical supply at the power outlet to the water heater.

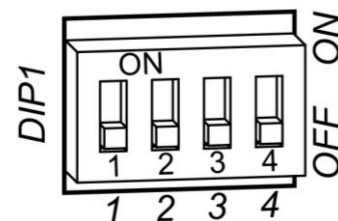
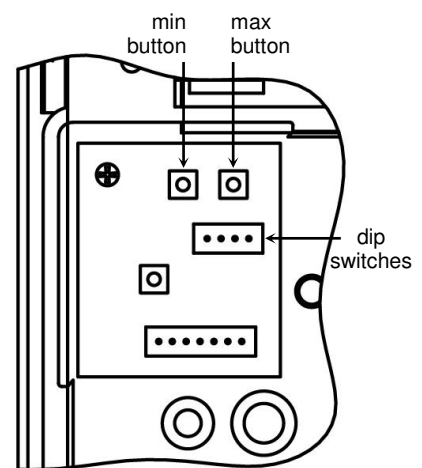
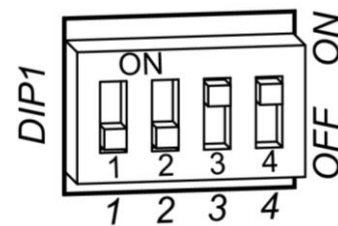

## OUTLET TEMPERATURE COMPENSATION ADJUSTMENT – 876 SERIES

The maximum outlet temperature of an 876 series 612 to 620 and E16 model water heater may be adjusted to compensate for temperature losses in the pipe work between the water heater outlet and sanitary fixtures.

### ⚠ Warnings

- After adjustment, the water temperature from the first tap in the hot water pipe work after the water heater used for personal hygiene purposes, such as in a bathroom or ensuite, **MUST NOT** exceed:
  - 48°C if a temperature controller is connected to the water heater, or
  - 50°C if a temperature controller is not connected to the water heater.
- If there is a tap, such as a kitchen or laundry tap, in the hot water pipe work between the water heater and the first tap used for personal hygiene purposes, then it is possible for a water temperature to be delivered from that tap of up to 3°C to 5°C higher than the setting shown on the controller.

It is necessary to have the electrical supply to the water heater switched on during stages of the outlet temperature compensation adjustment procedure.

### ⚠ Warnings

- The removal of the front panel will expose 240 volt wiring. Take care not to touch wiring terminals. The adjustment must be carried out by a qualified person.
- This procedure will involve the adjustment of dip switches. Adjustment of a dip switch should only be made with an insulated tool.

### Before Commencing the Procedure

This procedure cannot be conducted:

- With a temperature controller connected to the water heater.
  - A temperature controller(s) connected to the water heater must be disconnected prior to the commencement of this procedure. Refer to “[Disconnecting a Temperature Controller\(s\)](#)” on page 79.
- With an Ez-Link system set up on the water heaters.
  - The DIP SWITCHES need to be reset to the off (down) position on both water heaters prior to the commencement of this procedure.
  - The Ez-Link cable does not need to be disconnected.
  - The Outlet Temperature Compensation Adjustment procedure has to be performed individually on both water heaters.

Whilst the procedure is being conducted on one water heater, the other water heater has to be isolated by turning off the cold water isolation valve to the water heater.

### Disconnecting a Temperature Controller(s)

To disconnect the temperature controller(s):

1. Switch off the electrical supply at the power outlet to the water heater.
2. Unscrew and gently remove the front panel of the water heater.
3. Loosen the terminal screws to release the cable lugs.

The two remote controller terminals are adjacent to each other and located at the top right of the printed circuit board (PCB), to the right of the label marked ‘REMOTE CONTROLLER TERMINAL’.

4. Withdraw the cable lugs, ensuring they are well clear of the terminals.

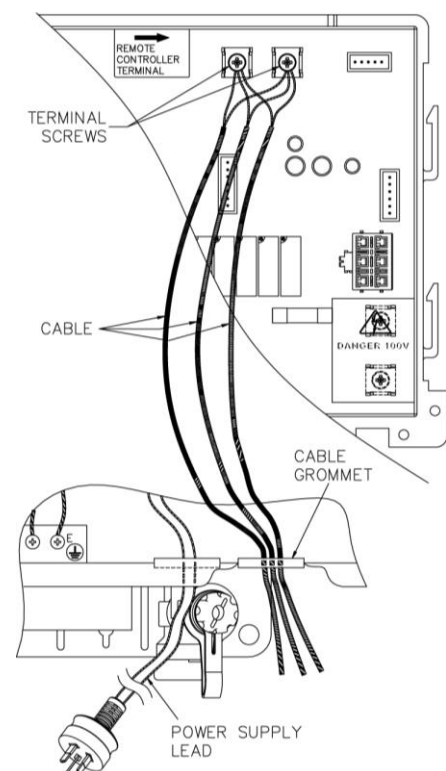

**Note:** The preset outlet temperature setting of this water heater must be set at 48°C prior to the commencement of this procedure. This procedure cannot be performed if the preset outlet temperature is set at 43°C or 45°C. Refer to [“To Check or Adjust the Preset Outlet Temperature Setting”](#) on page 78.

**Outlet Temperature Adjustment**

To adjust the outlet temperature:

1. Switch on the electrical supply at the power outlet to the water heater.
2. Locate the first hot tap in the hot water pipe work after the water heater used for personal hygiene purposes.
3. Turn on the hot tap.
4. Using a thermometer, measure the temperature of the water from the tap, until the temperature stops increasing.

If the water temperature is below:

- 48°C (if a temperature controller is to be connected), or
- 50°C (if no temperature controller is to be connected)

the maximum outlet temperature of the water heater can be adjusted upwards.

5. Turn off the hot tap.
6. Switch off the electrical supply at the power outlet to the water heater.
7. Remove the screws holding the front panel to the jacket.
8. Gently disengage the front panel and pull forward to remove from the water heater.
9. Switch on the electrical supply at the power outlet to the water heater.

**Note:** Wait five (5) seconds for the electronic system to initialise.

10. Switch DIP SWITCH 3 to the on (up) position on the I.C. Board.
11. Press the MAX button once to increase the outlet temperature setting to the next increment.

The red LED will only flash if a temperature compensation adjustment has previously been made.

Each press of the MAX button will increase the temperature setting by one increment.

The red LED will commence a series of flashes, with three (3) seconds between each series, to indicate the temperature setting.

The temperature setting increments and their number of flashes are:

- 48°C (no flashes), 50°C (1 flash), 51°C (2 flashes), 52°C (3 flashes), 53°C (4 flashes).

The MAX button is located above the DIP switches.

12. Switch DIP SWITCH 3 to the off (down) position on the I.C. Board.

The red LED will stop flashing.

**Note:** Wait five (5) seconds for the setting to be saved.

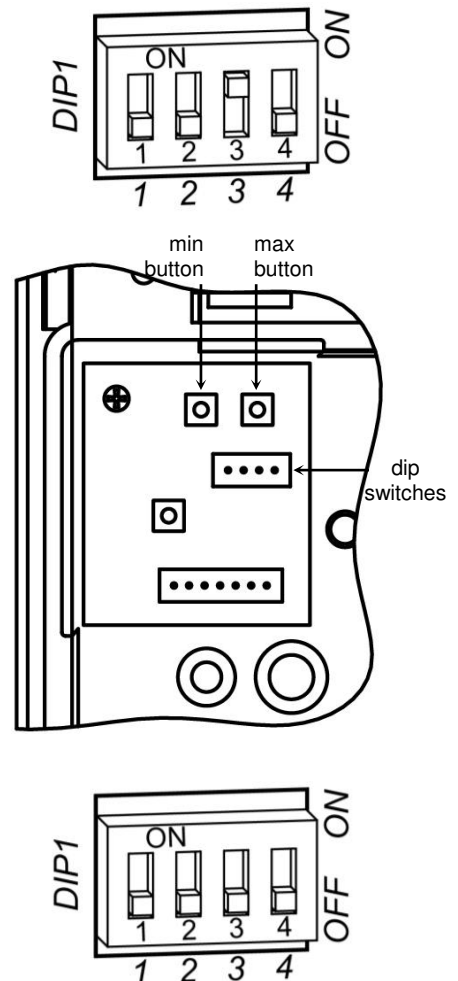

## 13. Repeat steps 2 to 5.

- if the water temperature is still below:

- 48°C (if a temperature controller is to be connected), or
- 50°C (if no temperature controller is to be connected)

and requires to be increased, repeat steps 10 to 12, followed by steps 2 to 5 until an acceptable water temperature not exceeding 48°C or 50°C respectively is measured at the same hot tap.

- if the water temperature exceeds 48°C or 50°C respectively then;

- switch DIP SWITCH 3 to the on (up) position on the I.C. Board.
- press the MIN button once to decrease the preset outlet temperature setting to the next increment.

Each press of the MIN button will decrease the preset temperature by one increment.

The MIN button is located above the DIP switches.

- switch DIP SWITCH 3 to the off (down) position on the I.C. Board.

**Note:** Wait five (5) seconds for the setting to be saved.

- repeat steps 2 to 5 to confirm the water temperature does not exceed 48°C or 50°C respectively.

## 14. Switch off the electrical supply at the power outlet to the water heater.

15. Reconnect the controller cables (if a temperature controller is fitted), by following step 4 of the procedure [“Connecting the Controller\(s\) to the Water Heater”](#) on page 71.16. Reset the dip switches if the water heater is part of an Ez-link system installation, by following steps 6 and 8 of the procedure [“Ez-Link Cable Connection”](#) on page 62.

## 17. Refit the front panel and screws to the water heater.

## 18. Switch on the electrical supply at the power outlet to the water heater.

**TO TURN OFF THE WATER HEATER**

If it is necessary to turn off the water heater on completion of the installation, such as on a building site or where the premises is vacant, then:

- Turn off the controllers(s) (if fitted) by pressing the on / off (⏻) button.

The on / off operating light will go out and the priority light, if it is on, will go out.

- Switch off the electrical supply at the power outlet to the water heater (refer to note below).
- Close the gas isolation valve at the inlet to the water heater.
- Close the cold water isolation valve at the inlet to the water heater.
- Drain the water heater if there is a risk of freezing conditions occurring (refer to [“Draining The Water Heater”](#) on page 82).

**Notes:**

- The frost protection system will be rendered inoperable if electrical power is not available at the water heater.
- Damage caused by freezing due to the unavailability of power at the water heater is not covered by the Rheem warranty (refer to [“Terms of the Rheem Warranty”](#) on page 83).
- If the power has been switched off to the water heater and there is a risk of freezing, then it is necessary to drain the water heater (refer to [“Draining the Water Heater”](#) on page 82).

---

## DRAINING THE WATER HEATER

---

To drain the water heater:

- Turn off the water heater (refer to [“Turn Off The Water Heater”](#) on page 81).
- Open a hot tap (preferably the shower outlet).
- Unscrew the two drain plugs, one each at the cold water inlet and hot water outlet, on the underside of the water heater.

Water will drain from the water heater.

- When water stops flowing from the water heater, close the hot tap.

**Note:** It is recommended not to screw the drain plugs back in, until the water heater is to be turned on again.

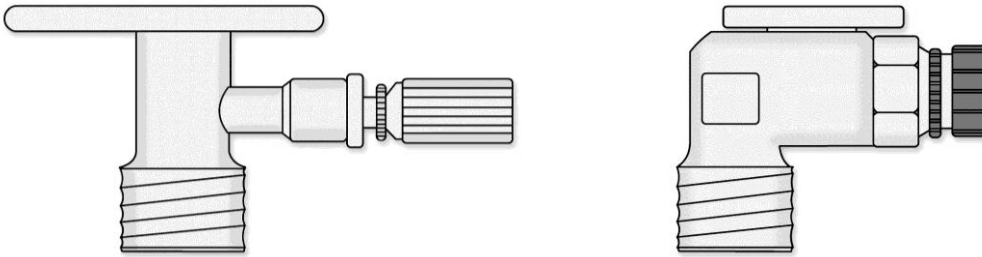

---

# RHEEM CONTINUOUS FLOW GAS WATER HEATER WARRANTY – AUSTRALIA ONLY

---

## CONTINUOUS FLOW GAS WATER HEATERS 874, 876 SERIES 612 – 620, E16 MODELS

### 1. THE RHEEM WARRANTY – GENERAL

- 1.1 This warranty is given by Rheem Australia Pty Limited ABN 21 098 823 511 of 1 Alan Street, Rydalmere New South Wales, the supplier of Rheem continuous flow gas water heaters, manufactured by Paloma Co., Ltd., a world leader in water heater technology and manufacture.
- 1.2 Rheem offer a trained and qualified national service network who will repair or replace components at the address of the water heater subject to the terms of the Rheem warranty. Rheem Service, in addition can provide preventative maintenance and advice on the operation of your water heater. The Rheem Service contact number is available 7 days a week on 131031 with Service personnel available to take your call from 8am to 8pm daily (hours subject to change).
- 1.3 For details about this warranty, you can contact us on 131031 or by email at [warrantyenquiry@rheem.com.au](mailto:warrantyenquiry@rheem.com.au) (not for service bookings).
- 1.4 The terms of this warranty and what is covered by it are set out in sections 2 and 3 and apply to water heaters manufactured after 1<sup>st</sup> October 2012.
- 1.5 If a subsequent version of this warranty is published, the terms of that warranty and what is covered by it will apply to water heaters manufactured after the date specified in the subsequent version.

### 2. TERMS OF THE RHEEM WARRANTY AND EXCLUSIONS TO IT

- 2.1 The decision of whether to repair or replace a faulty component is at Rheem's sole discretion.
  - 2.2 If you require a call out and we find that the fault is not covered by the Rheem warranty, you are responsible for our standard call out charge. If you wish to have the relevant component repaired or replaced by Rheem, that service will be at your cost.
  - 2.3 Where a failed component or cylinder is replaced under this warranty, the balance of the original warranty period will remain effective. The replacement does not carry a new Rheem warranty.
  - 2.4 Where the water heater is installed outside the boundaries of a metropolitan area as defined by Rheem or further than 25 km from either a regional Rheem branch office or an Accredited Rheem Service Agent's office, the cost of transport, insurance and travelling between the nearest branch office or Rheem Accredited Service Agent's office and the installed site shall be the owner's responsibility.
  - 2.5 Where the water heater is installed in a position that does not allow safe or ready access, the cost of that access, including the cost of additional materials handling and/or safety equipment, shall be the owner's responsibility. In other words, the cost of dismantling or removing cupboards, doors or walls and the cost of any special equipment to bring the water heater to floor or ground level or to a serviceable position is not covered by this warranty.
  - 2.6 This warranty only applies to the original and genuine Rheem water heater in its original installed location and any genuine Rheem replacement parts.
  - 2.7 The Rheem warranty does not cover faults that are a result of:
    - a) Accidental damage to the water heater or any component (for example: (i) Acts of God such as floods, storms, fires, lightning strikes and the like; and (ii) third party acts or omissions).
    - b) Misuse or abnormal use of the water heater.
    - c) Installation not in accordance with the Owner's Guide and Installation Instructions or with relevant statutory and local requirements in the State or Territory in which the water heater is installed.
    - d) Connection at any time to a water supply that does not comply with the water supply guidelines as outlined in the Owner's Guide and Installation Instructions.
    - e) Repairs, attempts to repair or modifications to the water heater by a person other than Rheem Service or a Rheem Accredited Service Agent.
    - f) Faulty plumbing or faulty gas or power supply.
    - g) Failure to maintain the water heater in accordance with the Owner's Guide and Installation Instructions.
    - h) Transport damage.
    - i) Fair wear and tear from adverse conditions (for example, corrosion).
    - j) Cosmetic defects.
    - k) Ice formation in the waterways of a water heater: where the electricity supply has been switched off or has failed and the water heater has not been drained in accordance with the instructions; or due to an ambient temperature below -20°C (including wind chill factor).
  - 2.8 Subject to any statutory provisions to the contrary, this warranty excludes any and all claims for damage to furniture, carpet, walls, foundations or any other consequential loss either directly or indirectly due to leakage from the water heater, or due to leakage from fittings and/ or pipe work of metal, plastic or other materials caused by water temperature, workmanship or other modes of failure.
  - 2.9 If the water heater is not sized to supply the hot water demand in accordance with the guidelines in Rheem's water heater literature, any resultant fault will not be covered by the Rheem warranty.
-

# RHEEM CONTINUOUS FLOW GAS WATER HEATER WARRANTY – AUSTRALIA ONLY

## CONTINUOUS FLOW GAS WATER HEATERS 874, 876 SERIES 612 – 620, E16 MODELS

### 3. WHAT IS COVERED BY THE RHEEM WARRANTY FOR THE WATER HEATERS DETAILED IN THIS DOCUMENT

3.1 Rheem will repair or replace a faulty component of your water heater if it fails to operate in accordance with its specifications as follows:

What components are covered	The period from the date of installation in which the fault must appear in order to be covered	What coverage you receive
All components	Year 1	Repair and/or replacement of the faulty component, free of charge, including labour.
All components (only if the water heater is installed in a single-family domestic dwelling)	Years 2 & 3	Repair and/or replacement of the faulty component, free of charge, including labour.
The heat exchanger (only if the water heater is installed in a single-family domestic dwelling)	Years 4 to 10	Replacement heat exchanger, free of charge. Installation and repair labour costs are the responsibility of the owner.

### 4. ENTITLEMENT TO MAKE A CLAIM UNDER THIS WARRANTY

- 4.1 To be entitled to make a claim under this warranty you need to:
- Be the owner of the water heater or have consent of the owner to act on their behalf.
  - Contact Rheem Service without undue delay after detection of the defect and, in any event, within the applicable warranty period.
- 4.2 You are **not** entitled to make a claim under this warranty if your water heater:
- Does not have its original serial numbers or rating labels.
  - Is not installed in Australia.

### 5. HOW TO MAKE A CLAIM UNDER THIS WARRANTY

- 5.1 If you wish to make a claim under this warranty, you need to:
- Contact Rheem on 131031 and provide owner's details, address of the water heater, a contact number and date of installation of the water heater or if that's unavailable, the date of manufacture and serial number (from the rating label on the water heater).
  - Rheem will arrange for the water heater to be tested and assessed on-site.
  - If Rheem determines that you have a valid warranty claim, Rheem will repair or replace the water heater in accordance with this warranty.
- 5.2 Any expenses incurred in the making of a claim under this warranty will be borne by you.

### 6. THE AUSTRALIAN CONSUMER LAW

- 6.1 Our goods come with guarantees that cannot be excluded under the *Australian Consumer Law*. You are entitled to a replacement or refund for a major failure and for compensation for any other reasonably foreseeable loss or damage. You are also entitled to have the goods repaired or replaced if the goods fail to be of acceptable quality and the failure does not amount to a major failure.
- 6.2 The Rheem warranty (set out above) is in addition to any rights and remedies that you may have under the *Australian Consumer Law*.

**RHEEM AUSTRALIA PTY LTD**, A.B.N. 21 098 823 511, [www.rheem.com.au](http://www.rheem.com.au)  
For Service Telephone 131 031 AUSTRALIA or 0800 657 335 NEW ZEALAND



31864740003

Revision Date: 2016 November

(31-86474-00 ©)

122479E