

Contents

Front panel	2	Troubleshooting	16
Safety instructions	3	Technical information	19
Before washing for the first time	4	Installation	20
Loading the dishwasher	5	ASKO Service	21
Using the dishwasher	8	Information for test institute	22
Settings	12	Your notes	23
Care and cleaning	14	Quick guide	24

Dear Customer,

Thank you for choosing this quality product from ASKO.

We hope it will meet your expectations and fulfil your needs for many years to come. Scandinavian design combines clean lines, everyday functionality and high quality. These are key characteristics of all our products and the reason they are greatly appreciated throughout the world.

To get the most out of your new dishwasher, we recommend that you read the Operating Instructions before using the dishwasher. The last page also includes a Quick guide.

Front panel

To switch on the dishwasher, press and hold the main power switch until the display lights up.

"Welcome to your new ASKO. This is a first time set up." is shown on the display the first time the dishwasher is switched on. It is important that you choose the right settings to ensure good dishwashing results. See page 4.

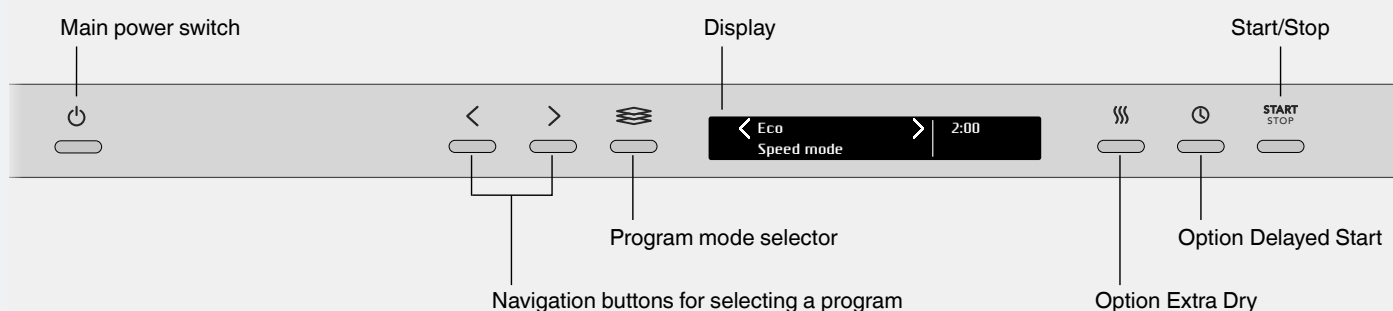



Safety instructions

- Read the operating instructions and keep them in a safe place!
- Number of place settings: 15
- Never use the dishwasher for any purpose other than that specified in these operating instructions.
- Do not load the dishwasher door or dishwasher baskets with anything other than dishes.
- Never leave the dishwasher door open as someone may trip on it.
- Use only dishwasher detergent!
- This appliance is not intended for use by persons (including children) with reduced physical, sensory or mental capabilities, or lack of experience and knowledge, unless they have been given supervision or instruction concerning use of the appliance by a person responsible for their safety.
- If the supply cord is damaged, it must be replaced by a special cord or assembly available from the manufacturer or its service agent.
- Damaged mains cables must only be replaced by a qualified electrician.
- Only use the dishwasher in domestic household environments for dishwashing household dishes. All other use is prohibited.
- Never place dishes with solvent residues in the dishwasher due to the risk of explosion. Nor may dishes that contain ash, wax or lubricants be washed in the dishwasher.

WARNING!

Knives and other pointed items must be placed with the points down in the cutlery basket or horizontally in other baskets.

Installation

See the chapter Installation.

Child safety

- Always start the dishwasher immediately after adding detergent.
- Keep children away from the dishwasher when the door is open. Some detergent may remain inside!
- Do not allow children to use or play with the dishwasher. Be especially vigilant when the door is open.

WARNING!

Dishwasher detergents are strongly alkaline. They can be extremely dangerous if swallowed. Avoid contact with skin and eyes and keep children away from the dishwasher when the door is open. Seek medical attention if swallowed.

Check that the detergent compartment is empty after completion of the wash cycle.

Activate child lock (Kid Safe™)

You can activate the child lock (button lock) to prevent children from starting the dishwasher. See the chapter Settings.

Winter storage/Transport

- Store the dishwasher where the temperature remains above freezing.
- Avoid long transport distances in very cold weather.
- Transport the dishwasher upright or laying on its back.

Overflow guard function

The overflow protection starts pumping out the machine and turns off the water supply if the water level in the dishwasher exceeds the normal level. If the overflow protection is triggered, turn off the water supply and call the service department.

Packing material

The packaging protects the product during transport. The packaging material is recyclable. Separate the different packaging materials to help reduce raw material use and waste. Your dealer can take the packaging for recycling or direct you to the nearest recycling centre. The packaging is comprised of:

- Corrugated cardboard made from up to 100% recycled material.
- Expanded polystyrene (EPS) with no added chlorine or fluorine.
- Supports made from untreated wood.
- Protective plastic made from polyethylene (PE).

Disposal

- When the dishwasher has reached the end of its service life and is to be disposed of, it should immediately be made unusable. Pull out the power cable and cut it as short as possible.
- The dishwasher is manufactured and labelled for recycling.
- Contact your local authority for information about where and how your dishwasher should be correctly recycled.

Before washing for the first time

1. Checking water hardness

Contact the local water utility to check the water hardness in your area. This is important with regard to how much detergent and rinse aid to use.

2. Basic settings

To switch on the dishwasher, press and hold the main power switch until the display lights up.

"Welcome to your new ASKO. This is a first time set up." is shown on the display. It is important that you choose the right settings to ensure good dishwashing results.

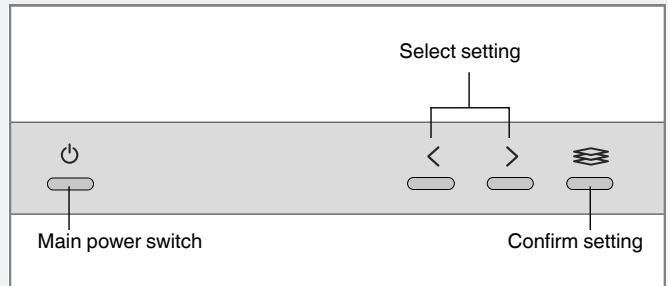

Settings

1 Language

Select the language to be shown on the display.

2 Rinse aid 0/1/2/3/4/5

By using rinse aid you will improve your drying result. You will also achieve a better dishwashing result with glassware and dishes.

Select rinse aid dosage. The rinse aid dispenser can be adjusted between 0 (Off) and 5 (High dosage).

Pre-selected at factory: 5

To change the chosen setting, see the chapter Settings.

3. Top up with rinse aid

By using rinse aid you will improve your drying result. You will also achieve a better dishwashing result with glassware and dishes.

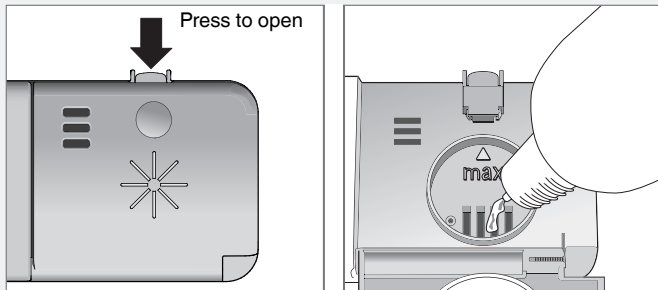

- 1 Open the rinse aid compartment lid.
- 2 Carefully top up with rinse aid. Only add rinse aid to the level marked **max**.
- 3 Wipe up any splashes of rinse aid around the compartment.
- 4 Close the lid firmly.

Top up rinse aid

When the rinse aid needs topping up, the above symbol lights on the display.

After topping up, it may take a while before the symbol goes out.

NOTE!

Increase the rinse aid dosage:

- If the dishes have water marks.

Decrease the rinse aid dosage:

- If the dishes have a sticky white/blue film.
- If the dishes are streaked.
- Build-up of foam. If you have very soft water, the rinse aid can be diluted 50:50 with water.

NOTE!

For water with a hardness greater than 10–12 °dH, you ought to use rinse aid with citric acid (known as acid rinse aid).

Energy-efficient dishwashing

Run programs only with a full load

Wait to run a program until the dishwasher is full. This way you save energy. Use the Rinse and hold program to rinse the dishes if there are any unpleasant odours while you wait for the dishwasher to become fully loaded.

Run programs at a lower temperature

If the dishes are only slightly dirty, you can select a program with a low temperature.

Select Green mode

The dishwasher has different program modes. To save energy and water, use Green mode.

Better drying results are achieved if you open the door a little once the program has ended. (If the dishwasher is built-in, the surrounding cabinets must be resistant to any condensation from the dishwasher.)

Do not rinse under running water

Simply scrape off large food particles before loading the dishwasher.

Choose a green detergent

Read the environmental declaration on the packaging!

Connect to cold water

Connect the dishwasher to the cold water supply if the building is heated using oil, electricity or gas.

Connection to hot water supply

Connect the dishwasher to the hot water supply (max. 70 °C) if the building is heated using an energy-efficient means such as district heating, solar power or geothermal power. Choosing a hot water connection cuts dishwashing times and reduces the dishwasher's energy consumption.

NOTE!

Do not exceed the permitted water supply temperature. Certain materials used in some cookware cannot withstand high heat.

Fragile dishes

Some cookware is not dishwasher safe. This can be for several reasons. Some materials cannot withstand strong heat, others can be damaged by dishwashing detergent.

Exercise caution with, for example, handmade items, fragile decoration, crystal/glassware, silver, copper, tin, aluminium, wood and plastic. Look for the "Dishwasher safe" marking.

Fragile decoration

Porcelain with decoration on top of the glazing (the items feel rough) should not be washed in a dishwasher.

Crystal/Glass

Wash fragile items made of crystal/glass, such as crystal glass from Orrefors, using the gentle dishwashing program Crystal glass. Remember to use only a small amount of detergent and to place items so that they do not touch each other during the wash.

By using rinse aid you will improve your drying result. You will also achieve a better dishwashing result with glassware and dishes.

Hand-painted glassware, as well as antique and very fragile items, should not be washed in a dishwasher.

Silver

Silver and stainless steel items should not come into contact, as the silver can become discoloured.

Aluminium

Aluminium can lose its shine if washed in a dishwasher. However, good quality aluminium pans can be washed in a dishwasher, even if some of the shine will be lost.

Cutlery with glued handles

Some types of glue are not dishwasher safe. In such cases, the handles may loosen.

Points to consider

- All dirty surfaces should face inwards and downwards!
- Dishes should not be placed in or on each other.
- Angle dishes with hollows, such as cups, so that the rinse water will run off. This is also important for plastic items.
- Make sure small items cannot fall through the dishwasher basket; place them in the top cutlery tray.

NOTE!

Check that the spray arms can rotate freely.

The dishwasher's baskets

The dishwasher is equipped with a top cutlery tray, an upper basket and a lower basket with a cutlery basket.

The appearance of the baskets may differ depending on the dishwasher setup.

Top cutlery tray

The top cutlery tray has space for cutlery, ladles, whisks, serving cutlery and similar items.

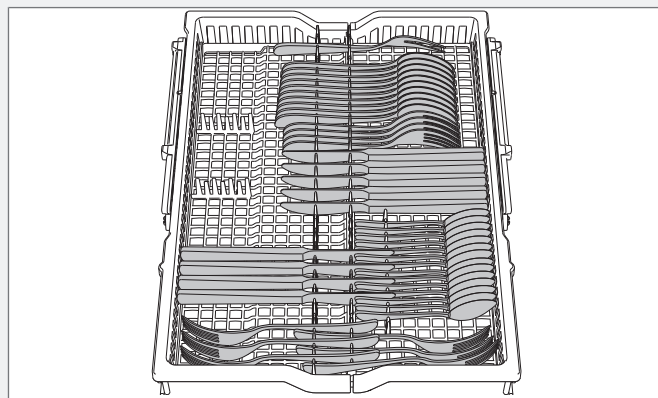

Raising the top cutlery tray

- 1 Pull out the top cutlery tray.
- 2 Pull the two locking handles on either side forward to raise the top cutlery tray.

Lowering the top cutlery tray

- 1 Make sure the upper basket is in the lowest position.
- 2 Pull out the top cutlery tray.
- 3 Slide the two locking handles on either side downwards and backwards to lower the top cutlery tray.

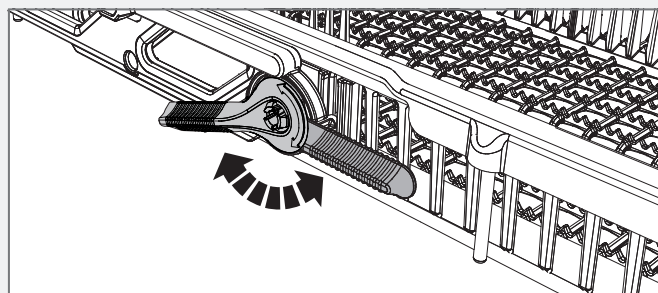

Upper basket

Place glasses, cups, bowls, side plates and saucers in the upper basket. All dirty surfaces should face inwards and downwards! Wine glasses are placed on the wine glass shelf and knives are placed in the knife stand on the right (if fitted).

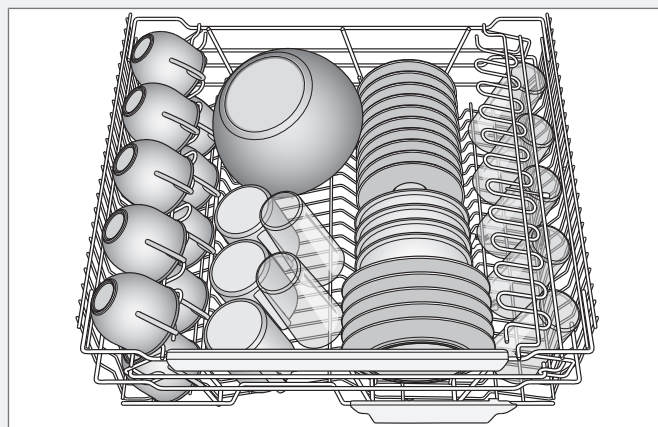

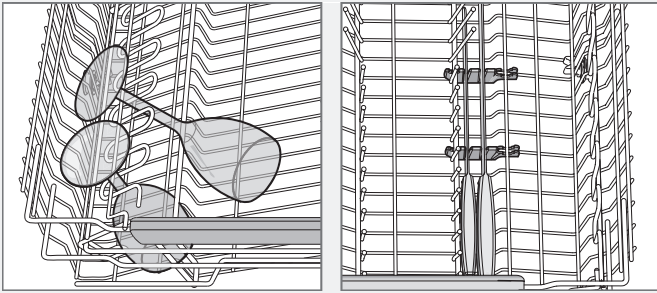

Raising the upper basket

- 1 Pull out the upper basket.
- 2 Grab the sides of the upper basket with both hands and lift it up.

Lowering the upper basket

- 1 Pull out the upper basket.
- 2 Pull out the two locking handles on either side to lower the upper basket.

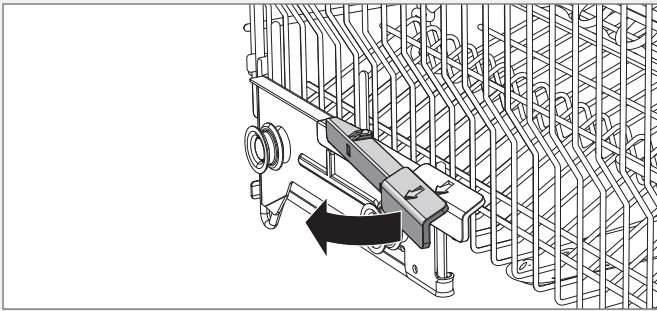

Lower basket

Place plates, side plates, serving dishes, pots and cutlery (in the cutlery basket) in the lower basket.

Place pots and pans in the rear right part of the lower basket to achieve the best dishwashing results from the rear of the two spray nozzles (WideSpray™), which are intended for these types of dishes.

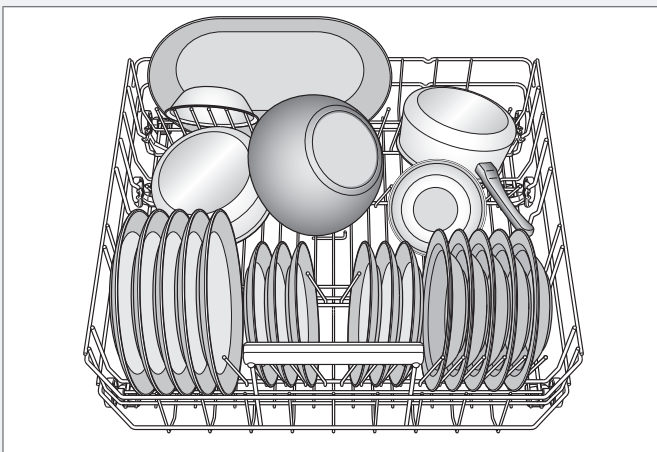

Foldable tines

Lower the foldable tines (plate supports) when washing pots and pans. Release the foldable tines by pressing the catch inwards before adjusting their position.

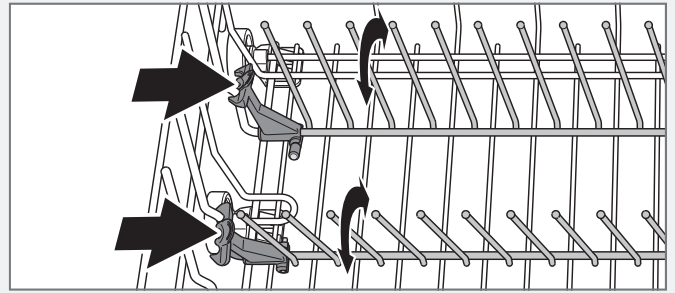

Washing large plates

Move the foldable tines and their mounts to widen the distance between the tine rows to adapt the lower basket to plates with a diameter greater than 25 cm.

Cutlery basket

Place cutlery with the handles facing down, except for knives, and spread them out as much as possible. Ensure that spoons do not stack inside each other.

The cutlery basket is best placed in the middle at the front of the lower basket to achieve the best dishwashing performance from the unique spray nozzle (Power Zone Cutlery™), which is intended for the cutlery basket.

! WARNING!

Knives and other pointed items must be placed with the points down in the cutlery basket or horizontally in other baskets.

Fold-down section for small items

The cutlery basket has a fold-down section in the middle for small items, or small shafts, such as electric whisk attachments.

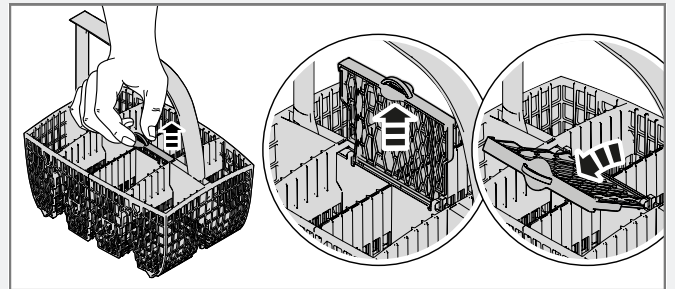

Using the dishwasher

Cutlery basket with lid

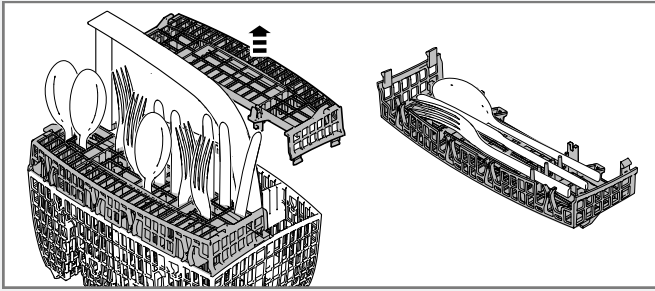

The cutlery basket lid can be removed and used, for example, as an extra cutlery basket in the upper basket (see below).

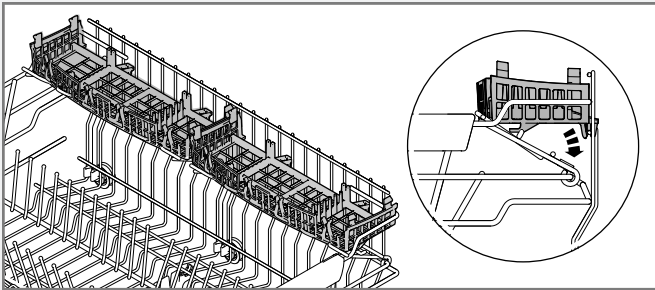

Accessory

Buy an extra cutlery basket. The extra cutlery basket is flexible and can be dismantled and attached to the lower basket or the large cutlery basket to make an extra large cutlery basket. This accessory is available where you purchased your dishwasher.

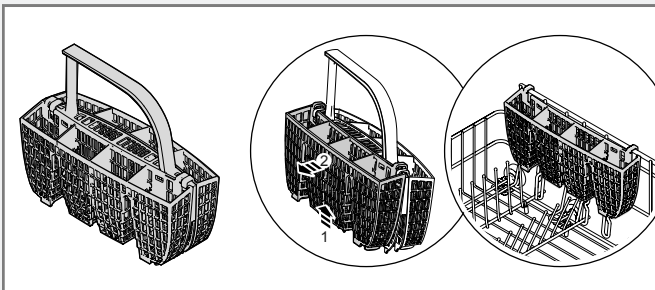

Add detergent

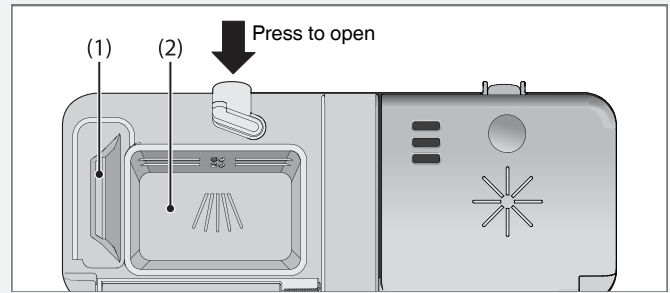

- 1 Prewash detergent compartment
- 2 Main wash detergent compartment

Detergent is added according to water hardness.

Follow the instructions on the detergent packaging.

Too much detergent can result in less effective dishwashing and also entails greater environmental impact.

The detergent compartment must be dry when adding detergent. There is one compartment for the prewash and one for the main wash. If powder or liquid dishwasher detergent is used, add a small amount of the detergent to the prewash compartment. Contact the detergent manufacturer if you have questions about the detergent.

NOTE!

Use only dishwasher detergent! Washing up liquid must not be used as the foam that forms prevents the dishwasher from operating effectively.

Dishwasher tablets

Halve the tablet if it is difficult to close the dispenser lid. There is a risk that the detergent will not be released properly if the lid is tight and will not open correctly.

NOTE!

Dishwasher tablets are not recommended for short programs (less than 75 minutes). Use powder or liquid dishwasher detergent instead.

All-in-one detergent

There are many types of all-in-one detergents on the market. Read the directions for these products carefully.

NOTE!

Optimal washing and drying results are achieved by using regular dishwashing powder or liquid detergent with separately dispensed rinse aid.

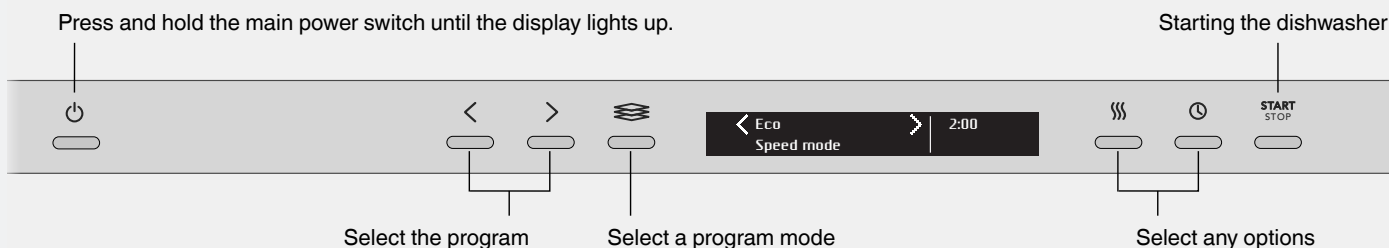

The main power switch

Press and hold the main power switch until the display turns on. Also check that the water tap is on.

Select a program

To select a program, press the Navigation button < or > until the desired program is shown on the display.

Choose a programme to suit the type of dishes and how dirty they are.

ECO wash

Use when you want to save water and energy. For normally soiled load, such as plates, serving dishes, cups, glasses and so on.

Heavy wash

Use to wash normally soiled load, such as plates, serving dishes, cups, glasses and so on.

Auto wash

The dishwasher can measure how dirty the dishes are and adjust water consumption and temperature accordingly. When newly installed, the program needs to be run five times before it is fully adapted and can provide the best results.

Sanitation wash

Program for very dirty dishes, such as pans, casserole dishes and oven dishes. If these dishes do not completely fill the dishwasher, you can add plates and the like.

Time program

The program adapts to the specified running time or finish time. With this program it is important to choose a time suited to how dirty the dishes are.

0:15-0:45	Slightly dirty dishes
1:00-1:30	Normally dirty dishes
2:00-2:30	Very dirty dishes

 – To set the desired program time, press and hold the option button.

Rinse and hold

Used to rinse dishes while you wait for the dishwasher to become fully loaded.

Plastic wash

A program intended for washing plastic items that are dishwasher safe. This program has an extra long drying cycle. Porcelain and glasses can also be washed.

Hygiene wash

This program is designed to meet strict hygiene demands.

Crystal glass

A gentle dishwashing program with a low temperature for washing fragile items made of crystal/glass, such as crystal glass from Orrefors.

Remember to use only a small amount of detergent and to place items so that they do not touch each other during the wash. See also Fragile dishes in the chapter Loading the dishwasher. Porcelain that has just been used without dried-on leftovers can also be washed using this program.

Quick Pro wash

Shorten the dishwashing program by preheating the water. This program is not intended for dried-on leftovers. Remember to scrape off larger food particles before loading the dishwasher.

1 To prepare the program, press and hold Start/Stop until the display shows "Preheating". Close the door. Wait until the display shows "Preheating ready".

You can load the dishes while the water is being preheated.

2 To start the program, press and hold Start/Stop until the display shows "Program started, close door". This indicates that the dishwasher is ready to start. Close the door properly, otherwise the dishwasher will not start.

Self-cleaning

Self-cleaning programme for hygienic cleaning of the dishwasher tub, spray arms and spray pipes.

This programme can be run (with no dishes in the machine) using normal dishwasher detergent or citric acid. Special dishwasher cleaners are also available on the market. For the removal of limescale deposits, see The dishwasher tub in the chapter Care and cleaning.

Upper half wash

You can use this program if you only have cups and glasses that need washing in the upper basket. Slightly dirty dishes can also be placed in the lower basket.

Lower half wash

You can use this program when you only want to wash plates and cutlery in the lower basket. Slightly dirty dishes can also be placed in the upper basket.

Select a program mode

To select a program mode, press the program mode selector until the desired mode is shown on the display. The available program modes vary between programs.

For a brief description, press and hold the program mode button.

Green mode

The dishwasher uses less energy and water. The program time is extended.

Speed mode

The program time is shortened, but the dishwasher uses more energy and water.

Night mode

Lower noise level during the dishwashing program. The program time is extended.

Intensive mode

Improves the dishwashing results, but the dishwasher uses more energy and water. The program time is extended.

Select an Option

To select an option, press the option button until the desired option is shown on the display. The available options vary between programs.

☺ Extra Dry

A higher temperature in the final rinse and a longer drying cycle improve the drying results if you activate this option. Energy consumption is slightly increased.

For a brief description, press and hold the button for Extra Dry.

🕒 Delayed Start

When you select Delayed Start, the dishwasher will start in 1-24 hours after you have pressed the button Start/Stop and closed the door.

- 1 Press the button once to activate Delayed Start. Press the button several times – or hold it in – to set the desired number of hours.
- 2 Press Start/Stop and close the door. The timer counts down and the dishwasher starts after the selected delay.

If you want to cancel the Delayed Start option, open the door and press and hold the main power switch until the display turns off.

TIP!

Activate the setting High temperature to improve the dishwashing results. Energy consumption is slightly increased.

START STOP Starting the dishwasher

Press and hold Start/Stop until the display shows "Program started, close door". This indicates that the dishwasher is ready to start. Close the door properly, or the dishwasher will not start.

If the dishwasher is not started or the door is not closed within 2 minutes of the last button press, the machine switches off.

Time remaining

Once you have chosen a program, a program mode and options, the time the program took when last used is displayed.

Stopping or changing a program

If you want to change program after starting the dishwasher, open the door then press and hold Start/Stop for three seconds. Add more detergent if the lid of the detergent dispenser has opened. Then choose a new program, press Start/Stop and close the door.

If you want to load more dishes

Open the door. The dishwasher stops automatically. Add the dishes and close the door. After a while, the dishwasher continues the program.

If the dishwasher is turned off due to a power failure

If the dishwashing program was not finished, the interrupted program continues when power is restored.

NOTE!

During drying, the program is interrupted if the power is cut or the door is open for more than 2 minutes.

Once the program has finished

Once the program has finished and the door is opened "Ready" appears on the display.

At the end of the program, you will hear a short beep. Chapter Settings describes how to change this function.

The dishwasher switches off automatically after the program ends. Turn off the water tap after each use.

How to get the best drying results

- Fully load the dishwasher.
- Angle dishes with hollows, such as cups, so that the rinse water will run off. This is also important for plastic items.
- Top up with rinse aid or increase the rinse aid dosage level.
- Activate the Extra Dry option.
- Open the door a little once the program has finished.
- Allow the dishes to cool before unloading the dishwasher.

Unloading the dishwasher

Hot porcelain is more fragile. Leave the dishes to cool in the dishwasher before unloading them.

Unload the lower basket first to avoid any water drops from the upper basket falling onto the dishes in the lower basket.

Program chart

Program	Detergent, compartment 2 (ml)	Prewashes	Main wash	Number of rinses	Final rinse	Consumption values ¹⁾					
						Cold water ²⁾		Hot water ³⁾		Energy (approx. kWh)	Water cons. (liter)
						Dishwashing time (approx. hrs:min)	Energy (approx. kWh)	Dishwashing time (approx. hrs:min)	Energy (approx. kWh)		
ECO wash ⁴⁾	25	2	48 °C	3	48 °C	2:50	0.8	2:30	0.5	12.2	
Heavy wash	25	2	60 °C	2	65 °C	2:25	1.2	2:05	0.6	13	
Auto wash	25	1-3	50-65 °C	2-3	65 °C	2:40-3:20	0.9-1.5	2:20-3:00	0.5-1.0	11-20	
Sanitation wash	25	2	60 °C	2	65 °C	1:55	1.2	1:35	0.6	15	
Time program	25	0-2	<65 °C	2-3	<65 °C	0:15-2:30	0.5-1.6	0:15-2:30	0.4-1.2	11-19	
Rinse and hold				1	--- °C	0:07	0.01	0:07	0.01	3	
Plastic wash	25	1	50 °C	2	68 °C	2:45	1.1	2:25	0.6	12	
Hygiene wash	25		70 °C	2	70 °C	1:10	1.4	1:00	0.9	10	
Crystal glass	20		45 °C	2	50 °C	1:40	0.8	1:20	0.5	9	
Quick Pro wash	20		60 °C	2	55 °C	0:30 + 0:20	0.9	0:20 + 0:20	0.6	10	
Upper half wash	20	1	60 °C	2	60 °C	2:10	1.0	1:50	0.6	12	
Lower half wash	20	1	60 °C	2	60 °C	2:10	1.0	1:50	0.6	12	

1) Consumption values vary depending on the temperature of the incoming water, room temperature, load size, selected additional functions and more.

2) Connection to cold water, approx. 20 °C.

3) Connection to hot water, approx. 60 °C.

4) The energy label performance figures are based on this program which is recommended for normally soiled load (no options).

Settings

Open the dishwasher's Settings menu

To open the dishwasher's Settings menu, press the Navigation button < or > until Settings menu is shown on the display and confirm your selection using the mode selector .

To exit the dishwasher's Settings menu, select Exit and confirm your selection using the mode selector .

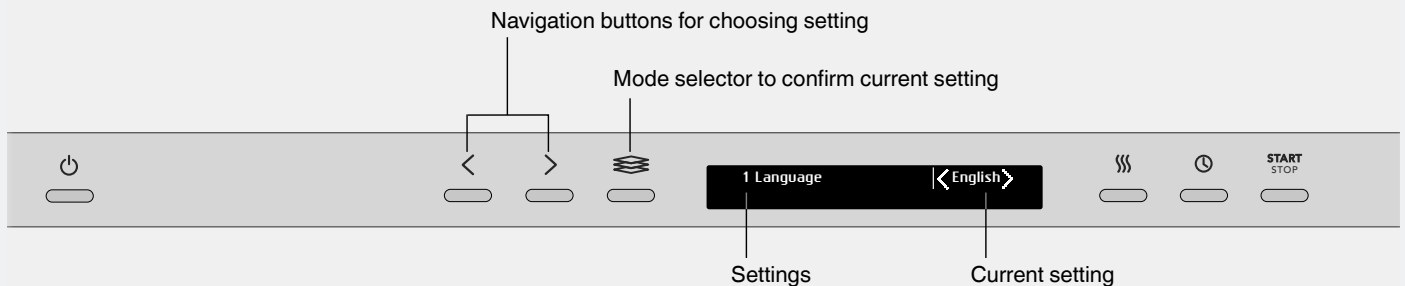

Settings	Options	
1. Language	English GB/English AU/English US/ Svenska/Dansk/Norsk/Suomi/Deutsch /Italiano/Nederlands/Français/Español	You can choose the language used for the display.
2. Select programs	Heavy wash <i>On/Off</i> ECO wash <i>On/Off</i> Auto wash <i>On/Off</i> Sanitation wash <i>On/Off</i> Time program <i>On/Off</i> Rinse and hold <i>On/Off</i> Plastic wash <i>On/Off</i> Hygiene wash <i>On/Off</i> Crystal glass <i>On/Off</i> Quick Pro wash <i>On/Off</i> Self-cleaning <i>On/Off</i> Lower half wash <i>On/Off</i> Upper half wash <i>On/Off</i>	Programs can be shown or hidden in the menu. Choose between On and Off.
3. Child lock	<i>On/Off</i>	You can activate the child lock (button lock) to prevent children from starting the dishwasher. <  To temporarily deactivate or activate the child lock, press and hold the left Navigation button and the option button Delayed Start for 3 seconds.
4. Display settings	Contrast top display 1/2/3/4	For adjusting the contrast of the display.
	Logo in top display <i>On/Off</i>	Setting to hide the logo shown on the display.
5. Feedback sound	0/1/2/3	This sound is used to confirm each button press.
6. Buzzer volume	0/1/2/3	The buzzer indicates when a dishwashing program has ended. <i>Error messages are always indicated by a loud buzzer.</i>
7. Rinse aid	0/1/2/3/4/5	Setting for rinse aid dosage. The rinse aid dispenser can be adjusted between 0 (Off) and 5 (High dosage). Increase the rinse aid dosage: <ul style="list-style-type: none"> • If the dishes have water marks. Decrease the rinse aid dosage: <ul style="list-style-type: none"> • If the dishes have a sticky white/blue film. • If the dishes are streaked. • Build-up of foam. If you have very soft water, the rinse aid can be diluted 50:50 with water.

Settings		Options	
8.	Super rinse	<i>On/Off</i>	<p>Super rinse adds two extra rinses.</p> <p><i>Activated in the following programs:</i></p> <p><i>Heavy wash</i></p> <p><i>ECO wash</i></p> <p><i>Sanitation wash</i></p> <p><i>Plastic wash</i></p> <p><i>Lower half wash</i></p> <p><i>Upper half wash</i></p>
9.	High temperature	<i>On/Off</i>	<p>Activate the setting High temperature to improve the dishwashing results. Energy consumption is slightly increased.</p> <p><i>Activated in the following programs:</i></p> <p><i>Heavy wash</i></p> <p><i>ECO wash</i></p> <p><i>Sanitation wash</i></p> <p><i>Plastic wash</i></p> <p><i>Quick Pro wash</i></p> <p><i>Lower half wash</i></p> <p><i>Upper half wash</i></p>

Care and cleaning

Coarse filter

The coarse filter traps larger food particles, which cannot get past the drainage pump. Empty the coarse filter as necessary.

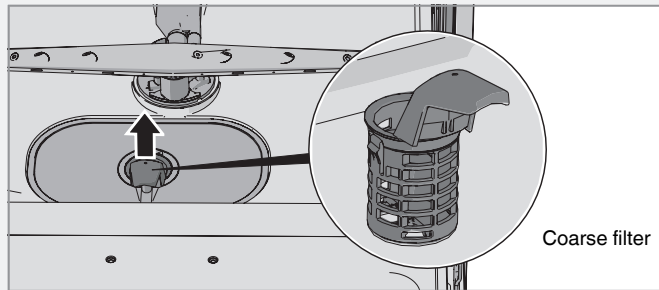

- 1 Lift the coarse filter by the handle.
- 2 Empty the coarse filter. Remember to replace it!

Fine filter

Debris that collects on the fine filter is automatically rinsed away during each wash. Clean the fine filter when necessary.

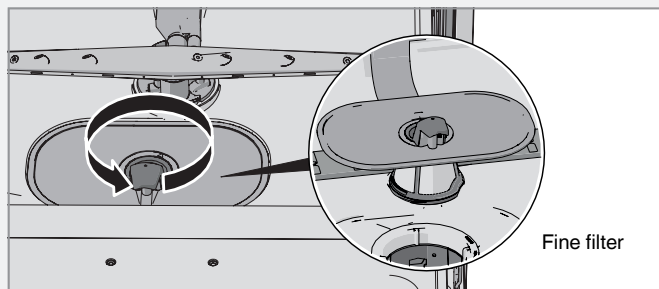

- 1 Turn the handle anticlockwise.
- 2 Lift the filter straight up using the handle. Free the coarse filter to clean the fine filter.
- 3 Replace in reverse order. Check that the edges seal properly when replacing the fine filter.
- 4 Lock the filter in place by turning the handle clockwise to the stop position. The handle should point straight out from the dishwasher.

NOTE!

The dishwasher must not be used without the filter in place!

Diswashing efficiency can be affected if the coarse filter is incorrectly fitted. After cleaning ensure that filter handle is fully locked with the handle pointing out of the dishwasher.

Spray arms

Holes and bearings can sometimes become blocked. Remove any debris using a pin or something similar. The spray arms also have holes on their undersides.

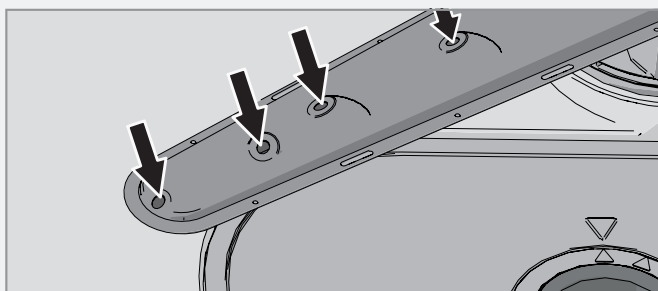

To facilitate cleaning, you can remove the spray arms. Remember to fit them firmly back into place after cleaning.

Top spray arm

- The upper basket must be removed before the top spray arm can be released. Pull out the upper basket and turn the basket catch on each runner outwards (see illustration). The basket can now be removed.

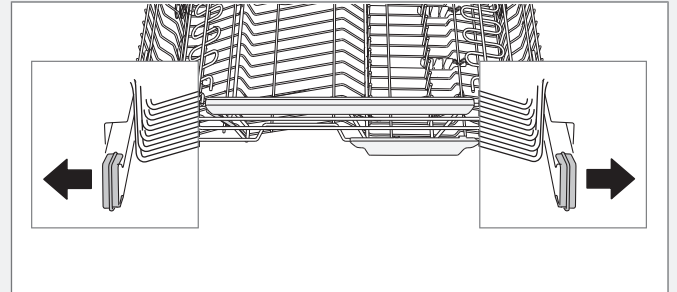

- Pull out the top cutlery tray. Press the top spray arm up and unscrew the spray arm bearings counter-clockwise to remove the spray arm.

Upper spray arm

- 1 Pull out the upper basket.
- 2 Unscrew the spray arm bearings counterclockwise to remove the spray arm from the upper basket.

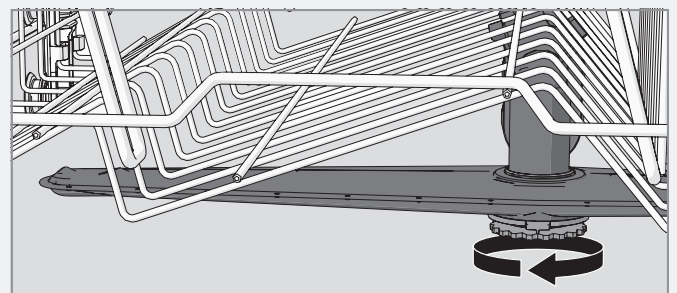

Lower spray arm

- Pull the lower spray arm straight up to release it.

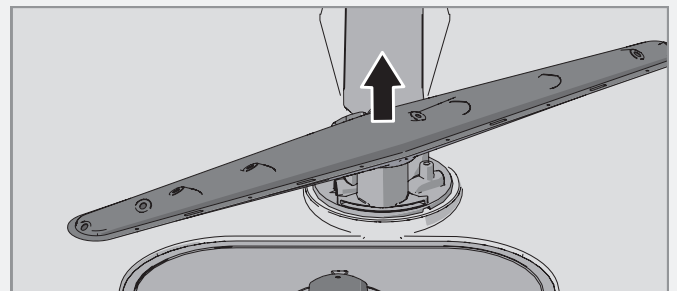

The door and the door seal

Regularly clean the sides of the door and the door seal. Use a slightly damp cloth (with a little cleaner if necessary).

Front panel

Keep the buttons clean and free from grease. Wipe them clean with a dry or slightly damp cloth. Never use cleaners – they can scratch the surface. Use the main power switch to turn off the dishwasher before cleaning the buttons to avoid activating any buttons unintentionally.

The dishwasher tub

The dishwasher tub is made of stainless steel and is kept clean through normal use.

Limescale deposits

If you have hard water, limescale deposits may build up in the dishwasher. If this happens, run the Self-cleaning program with two tablespoons of citric acid in the detergent compartment (with no dishes in the machine). Special dishwasher cleaners are also available on the market.

Unblocking the drainage pump

If the dishwasher still contains water after the programme has finished, something may be blocking the drainage pump. Such items are easily removed.

- 1 Turn off the machine using the main power switch and unplug it from the wall socket.
- 2 Remove the coarse filter and the fine filter.
- 3 Scoop out the water from the dishwasher tub.
- 4 In order to inspect the drainage pump, remove the coloured stop on the right in the bottom drain.
- 5 Turn the pump wheel located behind the drainage pump stop by hand. Carefully remove any items.
- 6 Replace the drainage pump stop along with the fine and coarse filters.
- 7 Plug the machine in again.

If the dishwasher still does not start and a whirring sound is heard, the overflow protection has been activated.

- Shut off the water.
- Remove the plug from the wall socket.
- Call the service department.

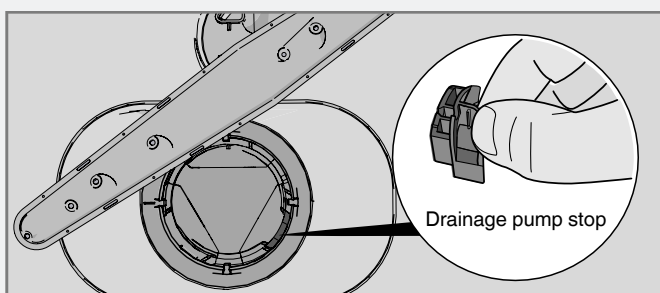

NOTE!

Do not forget to replace the drainage pump stop.

Unblocking the inlet hose filter

If the water supply contains small particles, the outer filter on the inlet hose may become blocked, which results in Water inlet fault.

- 1 Turn off the machine using the main power switch and unplug it from the wall socket.
- 2 Turn off the water tap.
- 3 Unscrew the inlet hose.
- 4 Carefully remove the outer filter from the inlet hose and clean it.
- 5 Replace the filter and check that the gasket is correctly positioned.
- 6 Screw the inlet hose firmly into place.
- 7 Plug the machine into the wall socket and turn on the water tap. Allow the pressure to settle for a while and check that the connection is watertight.

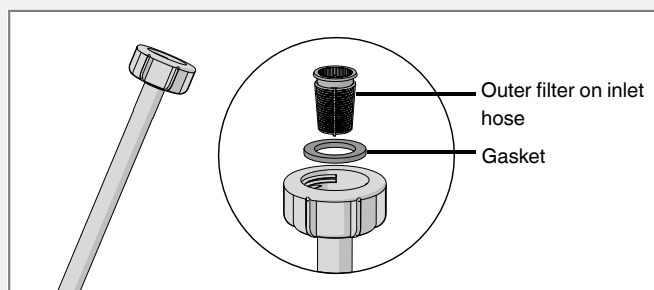

Troubleshooting

Type of fault on the display		Action
F10	Overfilling water 1	Clear the drainage pump. See the chapter Care and cleaning. If the problem persists, call the service department.
F11	Water outlet fault	See "Water remains in the dishwasher" in the table "Problem" below. If the problem persists, call the service department.
F12	Water inlet fault	Check whether dishwasher inlet hose is connected to a pressure limiting valve (some pressure limiting valves may restrict the supply of water to the dishwasher). Check that the water tap is on. Check that the outer filter on the inlet hose is not blocked. See Unblocking the inlet hose filter in the chapter Care and cleaning. If the problem persists, call for service. Check that the water tap is on. If the problem persists, call the service department.
F40	Inlet valve leakage	Turn off the water tap and call the service department.
F52	Water level fault	Call the service department.
F54	Overfilling water 2	Turn off the water tap and call the service department.
F56	Circ. pump fault	Call the service department.

Press any button to clear the error message.

Problem	Possible causes	Action
The buttons do not react when pressed.	You have pressed the buttons too soon after opening the door.	Wait a moment then try again.
	Child lock (button lock) activated.	See the chapter Settings.
	The door is closed.	Open the door. The buttons only react to use when the door is open.
	The buttons are dirty.	Clean with a dry or slightly damp cloth.
Cannot close door.	The baskets are not correctly positioned.	Check that the baskets are correctly positioned horizontally. Check that the dishes are not blocking the baskets from sliding properly into place.
	The dishwasher does not start.	Press and hold Start/Stop until the display shows "Program started, close door".
The dishwasher does not start.	The Start/Stop start button has not been pressed for long enough.	Check.
	The door is not properly closed.	Close the door and wait. After a while, the dishwasher continues the program.
	You have opened the dishwasher to add more dishes while a program is in progress.	Check.
	A fuse/circuit breaker has been tripped.	Check.
	The plug is not plugged into the wall socket.	Check.
	The water tap is turned off.	Check.
	Overflow/leaks	Check.
	A whirring sound (the drainage pump) is heard from the dishwasher and does not stop when the main power switch is turned off.	Turn off the water tap. Pull out the plug and call the service department.
Check that the Delayed Start option has not been selected.	Press and hold Start/Stop for three seconds if you want to cancel the Delayed Start option.	

Problem	Possible causes	Action
The dishes are not clean.	The spray arms do not rotate.	Check that the dishes are not blocking the spray arms.
	Spray arm holes or bearings blocked.	Clean the spray arms. See Chapter Care and cleaning.
	Unsuitable dishwashing program.	Choose a longer programme.
	Incorrect detergent dosage.	Dose according to water hardness. Far too much or far too little detergent results in poorer dishwashing results.
	Old detergent. Detergent is a perishable product.	Avoid large packages.
	Dishes loaded incorrectly.	Do not cover porcelain with large bowls or the like. Avoid placing very tall glasses in the corners of the baskets.
	Glasses and cups have toppled over during the program.	Place dishes to sit steady.
	The filters are not fitted correctly.	Check that the filter handle is locked in the stop position. The handle should point towards the back of the dishwasher.
Spots on stainless steel or silver.	Some foodstuffs, such as mustard, mayonnaise, lemon, vinegar, salt and dressings, can mark stainless steel if left for too long.	Rinse off these types of foodstuffs if not starting the dishwasher immediately. Use the Rinse and hold program.
	All stainless steel can cause spots on silver if they come into contact during dishwashing. Aluminium can also cause spots on dishes.	In order to avoid marks and tarnishing, separate dishes made from different metals, such as silver, stainless steel and aluminium.
Spots or films on the dishes.	Incorrect rinse aid dosage setting.	See the chapter Settings.
	Too high temperature and/or too much detergent can cause etching on crystal. Unfortunately, this cannot be repaired, only prevented.	Wash crystal at a low temperature and with a conservative amount of detergent. Contact the detergent manufacturer.
The dishes have a sticky white/blue film.	Rinse aid dosage setting too high.	Reduce the dosage. See the chapter Settings. If you have very soft water, you may want to dilute the rinse aid 50:50 with water.
Spots left after washing.	Lipstick and tea can be difficult to wash off.	Use a detergent with a bleaching agent.
Detergent residue in the detergent compartment after dishwashing.	The detergent compartment was damp when adding detergent.	The detergent compartment must be dry when adding detergent.
	The detergent compartment is blocked.	Check that the dishes are not preventing the detergent compartment from opening.
Rattling sound when dishwashing.	The dishes are not correctly placed or the spray arms are not rotating.	Check that the dishes are placed securely. Spin the spray arms to make sure they can rotate.

Problem	Possible causes	Action
Water remains in the dishwasher.	The filters are blocked.	Clean the coarse and fine filters.
	The filters are not fitted correctly.	Check that the filter handle is locked in the stop position. The handle should point towards the back of the dishwasher.
	Debris in the drainage pump.	Clean the drainage pump. See the chapter Care and cleaning.
	Kink in drainage hose.	Check that the hose is free from kinks and sharp bends.
	Blocked drainage hose.	Disconnect the drainage hose where it connects to the sink unit's water trap. Check that no debris has fastened and that the connection has an inner diameter of at least 14 mm.
Bad odour in dishwasher.	Dirt around the seals and in corners.	Clean with washing-up brush and low foaming cleaner.
	Low temperature programs have been selected for a prolonged period.	Run a program with a higher temperature once or twice a month. Or run a self-cleaning program. See Self-cleaning in Chapter Using the dishwasher.
The dishes are not dry enough.	Depending on the load, the programme's drying cycle may be insufficient.	Activate the Extra Dry option.
	The dishwasher is not fully loaded.	Fully load the dishwasher.
	Rinse aid needs topping up or dosage is set too low.	Top up with rinse aid or increase the rinse aid dosage level. See the chapter Settings.
		Open the door a little once the program has finished.

Technical information

Information on energy labelling

Energy labelling

Australian standard:	AS/NZS 2007
Number of place settings:	15
Dishwashing programs:	ECO wash ¹⁾ , no options
Program time:	2:50 hours:minutes
Connection:	Cold water 20 °C
Test method for noise measurement:	IEC 60704-2-3

¹⁾ *This dishwashing program is the standard cleaning cycle used to compile the energy labelling information. It is intended for washing normally dirty dishes and is the most effective program in terms of combined energy and water consumption.*

Technical data

Height:	859-912 mm
Width:	596 mm
Depth:	559 mm
Weight:	50 kg ¹⁾
Water pressure:	0.03–1.0 MPa
Electrical connection:	See compliance plate
Rated power:	See compliance plate

¹⁾ *Weight can vary due to different specifications.*

Installation

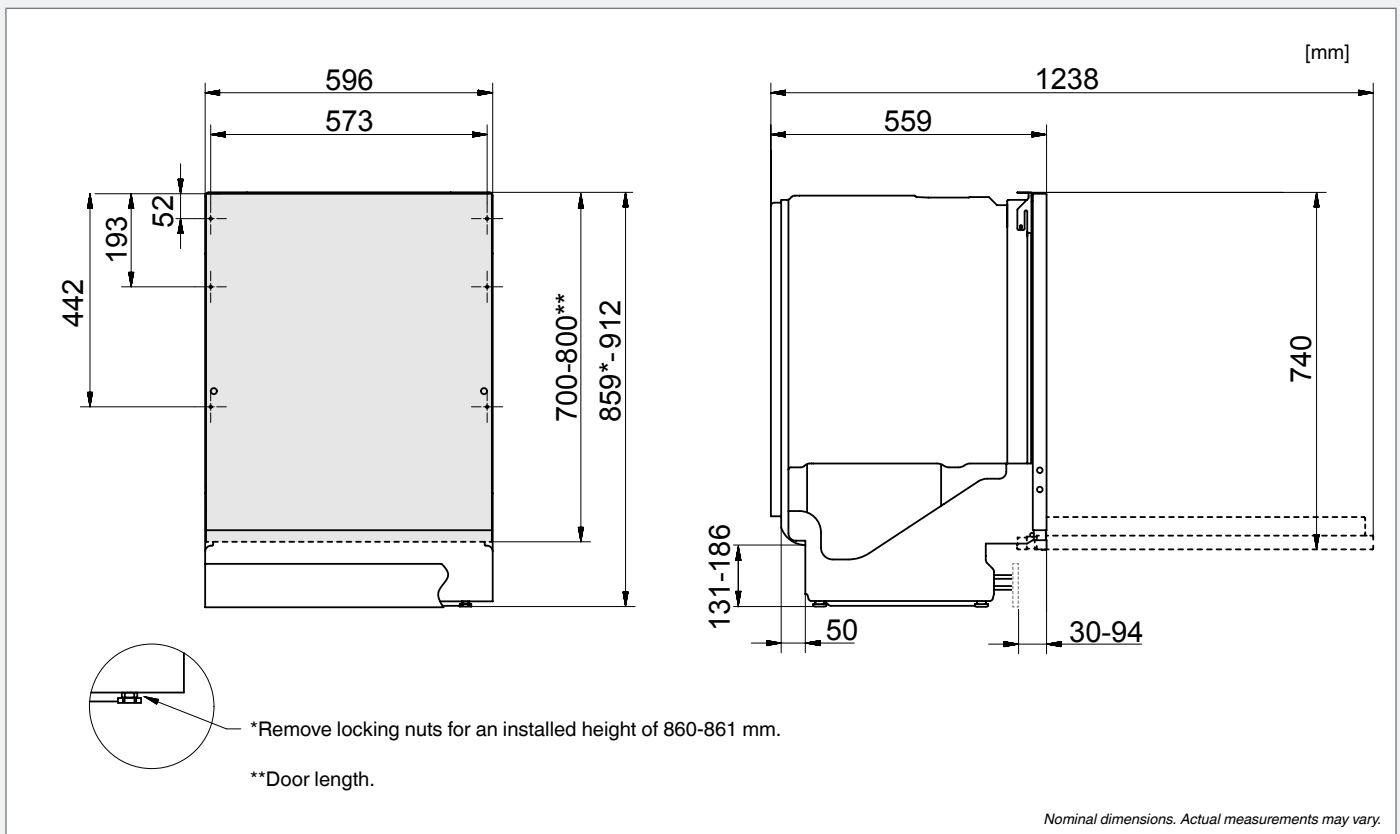

It is important that you read through and follow the instructions and directions below. Conduct installation and connection in accordance with the separate installation instructions.

Safety instructions

- Connections to electricity, water and drainage must be performed by a qualified professional.
- Always follow applicable regulations for water, drainage and electricity.
- Take care during installation! Wear protective gloves! There must always be two people!
- Before screwing the dishwasher into place, test the dishwasher by running the Rinse and hold program. Check that the dishwasher fills with water and drains. Check also that none of the connections leak.

⚠ WARNING!

Turn off the water supply when installing the dishwasher!

The plug must be disconnected or power to the socket turned off while the work is carried out!

Setup

- The dimensions and connection information are included in the separate installation instructions. Check that all dimensions and connections are correct before commencing the installation. Note that the height of the exterior panel can be adjusted to match other fittings.
- Make sure the area on which the dishwasher is to be installed is firm. Adjust the adjustable feet so that the dishwasher is level. Tighten the lock nuts.

Drainage connection

See the separate installation instructions for necessary information.

This dishwasher is suitable for installing in a raised recess (to attain an ergonomic working height). This means that the dishwasher can be placed so that the drainage hose runs to a lower level than the bottom of the dishwasher, such as by routing it directly to a floor drain. The dishwasher is fitted with an integrated anti-siphon device to prevent the machine from being emptied of water during the wash cycle.

The drainage hose can also be connected to a connection nipple on the sink unit's water trap. The connection nipple must have an internal diameter of at least 14 mm.

The drainage hose may be extended by a maximum of 2.5 m (the total length of the drainage hose must not exceed 4.5 m). Any joints and connecting pipes must have an internal diameter of at least 14 mm. However, the drainage hose should ideally be replaced with a new hose without joints.

No part of the drainage hose may be more than 950 mm above the bottom of the dishwasher.

Ensure that the drainage hose has no kinks.

Connection to water supply

Use only the inlet hose supplied with the dishwasher. Do not re-use old or other spare hoses.

The supply pipe must be fitted with a water tap (stopcock). The water tap must be easily accessible, so that the water can be shut off if the dishwasher has to be moved.

Once the installation is complete, turn on the water tap and allow the pressure to settle for a while. Check that all connections are watertight.

Connection to cold water supply

Connect the dishwasher to the cold water supply if the building is heated using oil, electricity or gas.

Connection to hot water supply

Connect the dishwasher to the hot water supply (max. 70 °C) if the building is heated using an energy-efficient means such as district

heating, solar power or geothermal power. Choosing a hot water connection cuts dishwashing times and reduces the dishwasher's energy consumption.

NOTE!

Do not exceed the permitted water supply temperature. Certain materials used in some cookware cannot withstand high heat. See Fragile dishes in the chapter Loading the dishwasher.

NOTE!

Connecting a dishwasher to the water supply via certain types of pressure limiting valves may restrict the water supply!
This may cause the error message Water inlet fault to be displayed.

Electrical connection

Information about the electrical connection can be found on the compliance plate. This specification must match the electricity supply.

The dishwasher must be connected to an earthed wall socket.

The electric wall socket must be placed outside of the installation area to be easily accessible after installing the dishwasher. Do not use an extension cord!

NOTE!

Repairs and maintenance must be carried out by a qualified professional.

Information about your product

There is a QR code on the compliance plate. Scan the code to view information about your product.

Contact the service department

Read the chapter Troubleshooting before contacting the service department. If you have encountered a problem that you cannot resolve, please contact your nearest dealer, see www.asko.com.

When making contact, provide the details on the serial number plate. Include the article number (1) and the serial number (2).

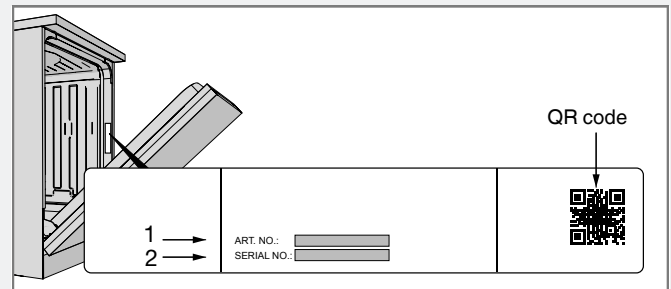

Information for test institute

Request test institute information via e-mail dishwashers@appliance-development.com.

The request should include the details on the product's serial number plate. Include the article number (1) and the serial number (2).

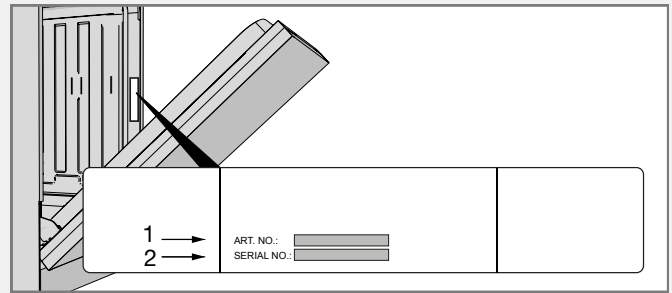

Quick guide

1.

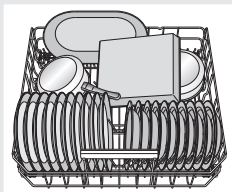

Load the baskets

(See page 5.)

Do not rinse dishes under running water before loading them in the dishwasher. Simply scrape off large food particles before loading the dishwasher.

2.

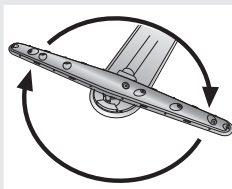

Check that the spray arms can rotate freely

Check also that the water tap is on.

Don't forget! Empty the coarse filter and clean the fine filter when necessary. (See page 14.)

3.

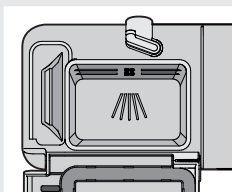

Add detergent

The detergent compartment has one smaller compartment for the prewash and one for the main wash. (See page 8.)

4.

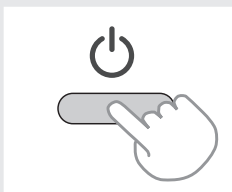

Press and hold the main power switch until the display lights up

5.



Check/Add rinse aid

Use rinse aid to achieve good washing and drying results. (See page 4.)

💧 Refill rinse aid indicator.

6.

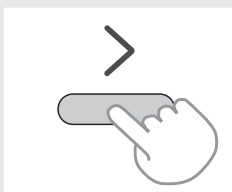

Select a program, a program mode and any options

(See page 9.)

7.

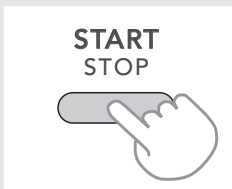

Press Start/Stop, close the door

ASKO

