

<b>PRECAUTIONS</b>	<b>52</b>	Digital programmer	61
General safety instructions	52	First use	62
Appliance purpose	55	Using the oven	63
This user manual	56	Cooking advice	71
Manufacturer's liability	56	Mini guide to accessories	73
Identification plate	56	Discover the recipes	73
Disposal	56	Information for Supervisory Bodies	73
Information for European Control Bodies	56	Special functions	73
Energy efficiency technical data	56	Secondary functions	77
To save energy	56	Settings	78
Light sources	57	Other settings	81
How to read the user manual	57	<b>CLEANING AND MAINTENANCE</b>	<b>81</b>
<b>DESCRIPTION</b>	<b>57</b>	Cleaning the appliance	81
General description	57	Cleaning the door	82
Control panel	58	Cleaning the oven cavity	83
Other parts	58	Special cleaning functions	85
Accessories	58	Vapor Clean (on some models only)	85
Optional accessories (can be purchased separately)	59	Descaling	87
Advantages of steam cooking	60	Cleaning the reservoir and hydraulic circuit	90
<b>USE</b>	<b>60</b>	Extraordinary maintenance	92
Preliminary operations	60	<b>INSTALLATION</b>	<b>92</b>
Using the accessories	61	Electrical connection	92
		Positioning	93

We advise you to read this manual carefully, which contains all the instructions for maintaining the appliance's aesthetic and functional qualities. For further information on the product: [www.smeg.com](http://www.smeg.com)

## PRECAUTIONS

### General safety instructions

#### Risk of personal injury

- **ATTENTION:** during use, the appliance and its accessible parts become very hot. Children must be kept away from the appliance.
- **ATTENTION:** during use, the appliance and its accessible parts become very hot. Never touch the heating elements during use.
- Protect your hands by wearing oven gloves when moving food inside the oven.
- Never try to put out a fire or flames with water: turn off the appliance and smother the flames with a fire blanket or other appropriate cover.
- This appliance may be used by children aged at least 8 and by people of reduced physical, sensory or mental capacity, or lacking in experience in the use of electrical appliances, provided that they are supervised or instructed by adults who are responsible for their safety.

- Children must not play with the appliance.
- Keep children under the age of 8 at a safe distance unless they are constantly supervised.
- Keep children under the age of 8 away from the appliance when it is in use.
- Cleaning and maintenance must not be carried out by unsupervised children.
- The cooking process must always be monitored. A short cooking process must be continuously surveyed.
- Never leave the appliance unattended during cooking operations where fats or oils could be released, as these could then heat up and catch fire. Be very careful.
- Do not pour water directly onto very hot trays.
- Keep the oven door closed during cooking.
- If you need to move food or at the end of cooking, open the door 5 cm for a few seconds, let the steam come out, then open it fully.
- Do not insert pointed metal objects (cutlery or utensils) into the slots in the appliance.
- Switch off the appliance immediately after use.
- DO NOT USE OR STORE FLAMMABLE MATERIALS NEAR THE APPLIANCE.
- DO NOT USE AEROSOLS IN

THE VICINITY OF THIS APPLIANCE WHILST IT IS IN USE.

- DO NOT MODIFY THIS APPLIANCE.
- Installation and servicing should be carried out by qualified personnel in accordance with current standards.
- Do not try to repair the appliance yourself or without the assistance of a qualified technician.
- Do not pull the cable to unplug the appliance.

### **Risk of damaging the appliance**

- Do not use abrasive or corrosive detergents (e.g. scouring powders, stain removers and metallic sponges), rough or abrasive materials or sharp metal scrapers on glass parts as this could cause scratch the surface and break the glass. Use wooden or plastic utensils.
- Do not sit on the appliance.
- Do not use cleaning products containing chlorine, ammonia or bleach on parts made of steel or that have metallic surface finishes (e.g. anodizing, nickel- or chromium-plating).
- Racks and trays should be inserted as far as they will go into the side guides. The mechanical safety locks that prevent them from being

removed must face downwards and towards the back of the oven cavity.

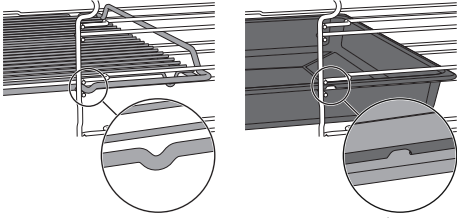

- Do not use steam jets to clean the appliance.
- Do not spray any spray product near the appliance.
- Do not obstruct ventilation openings and heat dispersal slots.
- Fire hazard: never leave objects in the oven cavity.
- **DO NOT FOR ANY REASON USE THE APPLIANCE AS A SPACE HEATER.**
- Do not use plastic cookware or containers when cooking food.
- Do not place sealed tins or containers in the oven cavity.
- Remove all trays and racks which are not required during cooking.
- Do not cover the bottom of the oven cavity with aluminium or tin foil sheets.
- Do not place pans or trays directly on the bottom of the oven cavity.
- If necessary, you can use the tray rack (supplied or sold separately, depending on the model) by placing it on the bottom as a support for

cooking.

- If you wish to use greaseproof paper, place it so that it will not interfere with the hot air circulation inside the oven cavity.
- Do not use the open door to rest pans or trays on the internal glass pane.
- Never use the oven door to lever the appliance into place when fitting.
- Avoid exerting too much pressure on the door when open.
- Do not use the handle to lift or move this appliance.

### Installation and maintenance

- **THIS APPLIANCE MUST NOT BE INSTALLED IN A BOAT OR CARAVAN.**
- The appliance must not be installed on a pedestal.
- Position the appliance into the cabinet cut-out with the help of a second person.
- To prevent any possible overheating, the appliance should not be installed behind a decoration door or a panel.
- Installation and servicing should be carried out by qualified personnel in accordance with current standards.
- Have the electrical connection performed by authorised technical personnel.
- The appliance must be

connected to ground in compliance with electrical system safety standards.

- Use cables withstanding a temperature of at least 90 °C.
- The tightening torque of the screws of the terminal supply wires must be 1.5 - 2 Nm.
- If the power cable becomes damaged, contact technical support immediately to arrange for it to be replaced in order to avoid possible hazards.
- Always use any necessary/required personal protective equipment (PPE) before performing any work on the appliance (installation, maintenance, positioning or movement).
- Before performing any operation on the appliance, switch off the power supply.
- Disconnect the appliance after the installation, through an accessible plug or switch in case of fixed connection.
- Fit the power line with an all-pole circuit breaker with a contact separation distance sufficient to provide complete disconnection in category III overvoltage conditions, pursuant to installation regulations.
- **WARNING:** Make sure that the appliance has been switched off and disconnected from the mains power supply or

that the mains power has been switched off before replacing the interior lighting bulbs.

- The bulbs used in this appliance are specific for household appliances; do not use them for home lighting.
- This appliance can be used up to a maximum altitude of 4,000 metres above sea level.

### **For this appliance**

- **WARNING:** ensure that the appliance is switched off before replacing the bulb, to prevent electric shocks.
- Do not rest any weight or sit on the open door of the appliance.
- Take care that no objects are stuck in the doors.
- Do not install/use the appliance outdoors.
- (on some models only) Only use the temperature probe provided or recommended by the manufacturer.
- For cooking with the Direct Steam function, take great care not to exceed the maximum capacity of the tray (250 ml).

### **Appliance purpose**

This appliance is intended for cooking food in the home environment. Every other use is considered inappropriate. It cannot be used:

- in employee kitchens, shops, offices and other working

environments.

- in farms/farmhouses.
- by guests in hotels, motels and residential environments.
- In bed and breakfast accommodation.

## This user manual

- This user manual is an integral part of the appliance and must therefore be kept in its entirety and within the user's reach for the whole working life of the appliance.
- Read this user manual carefully before using the appliance.
- The explanations in this manual include images, which describe all that regularly appears on the display. However, it should be kept in mind that the appliance may be equipped with an updated version of the system, and as such, all that appears on the display may differ from those in the manual.

## Manufacturer's liability

The manufacturer declines all liability for damage to persons or property caused by:

- use of the appliance other than that specified;
- failure to comply with the instructions in the user manual;
- tampering with any part of the appliance;
- use of non-original spare parts.

## Identification plate

The identification plate bears the technical data, serial number and brand name of the appliance. Do not remove the identification plate for any reason.

## Disposal



This appliance conforms to the WEEE European directive (2012/19/EU) and must be disposed of separately from other waste at the end of its service life.

The appliance does not contain substances in quantities sufficient to be considered hazardous to health and the environment, in accordance with current European directives.



**Power voltage**  
**Danger of electrocution**

- Disconnect the mains power supply.



**Power voltage**  
**Danger of electrocution**

- Unplug the appliance.

To dispose of the appliance:

- Cut the power cable and remove it.
- Deliver the appliance to the appropriate recycling centre for electrical and electronic equipment waste, or return it to the retailer when purchasing an equivalent product, on a one for one basis.

Our appliances are packaged in non-polluting and recyclable materials.

- Deliver the packing materials to the appropriate recycling centre.



**Plastic packaging**  
**Danger of suffocation**

- Do not leave the packaging or any part of it unattended.
- Do not let children play with the plastic bags.

## Information for European Control Bodies

### Fan forced mode

the ECO function used to define the energy efficiency class complies with the specifications of European standard EN 60350-1.

### Conventional heating mode

To run the STATIC function, the preheating phase must be skipped (see section "Preheating phase" in the USE chapter).

## Energy efficiency technical data

Information in accordance with the European energy labelling and ecodesign regulations is contained in a separate document accompanying the product instructions.

These data are present in the "Product information sheet" that can be downloaded from the website at the page dedicated to the product in question.

## To save energy

- Only preheat the appliance if the recipe requires you to do so. The preheating stage can be disabled for all functions (see chapter "Preheating") apart from the PIZZA (preheating cannot be disabled) and ECO functions (no preheating stage).

- When using the functions (including the ECO function), avoid opening the door during cooking.
- Unless otherwise indicated on the package, defrost frozen foods before placing them in the oven.
- When cooking several types of food it is recommended to cook the foods one after the other to make the best use of the already hot oven.
- Use dark metal moulds: They help to absorb the heat better.
- Remove all trays and racks which are not required during cooking.
- Stop cooking a few minutes before the time normally used. Cooking will continue for the remaining minutes with the heat which has accumulated inside the oven.
- Reduce any opening of the door to a minimum to avoid heat dispersal.
- Keep the inside of the oven clean at all times.

### Light sources

- This appliance contains user-replaceable

light sources.

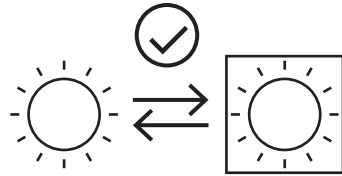

- The light sources contained in the appliance are declared suitable for operation at ambient temperature  $\geq 300^{\circ}\text{C}$  and intended for use in high temperature applications such as ovens.
- This appliance contains light sources of efficiency class "G".

### How to read the user manual

This user manual uses the following reading conventions:



Warning/Caution



Information/Advice

## DESCRIPTION

### General description

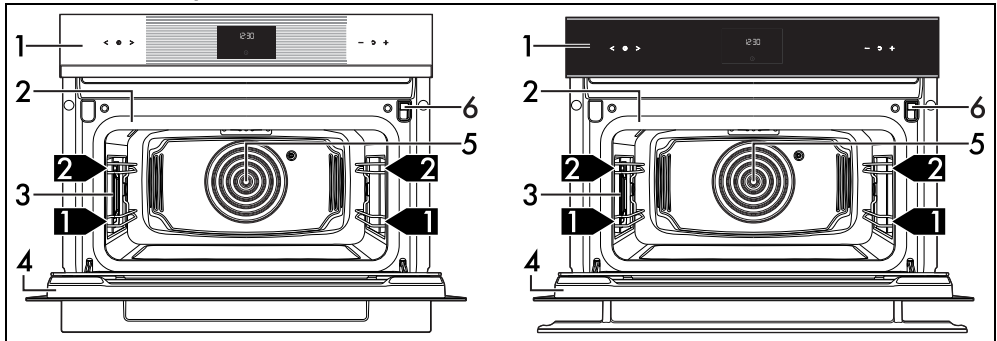

1 Control panel

2 Seal

3 Light bulb

4 Door

5 Fan

6 Loading tray

**1,2,3** Frame shelf

## Control panel

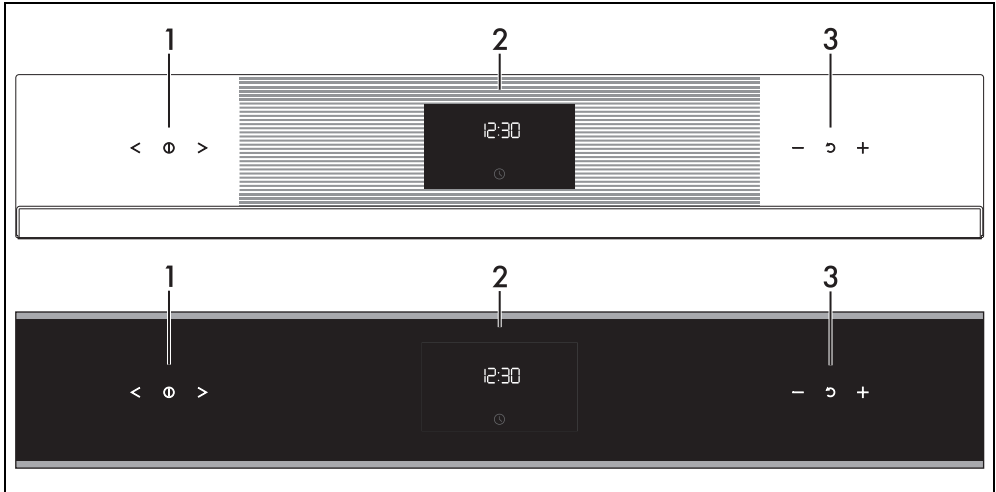

### 1 Function touch buttons

By means of these touch buttons you can:

- turn the appliance on and off;
- select a function.

### 2 Digital programmer

Displays the current time, the selected cooking temperature, power and function and any time set.

### 3 Temperature touch buttons

By means of these touch buttons you can set:

- the cooking temperature;
- the duration of a function;
- programmed cooking cycles;
- the current time;
- temporarily start or stop a function.

## Other parts

### Shelves

The appliance features shelves to position trays and racks at different heights. The insertion heights are indicated from the bottom upwards.

## Cooling fan

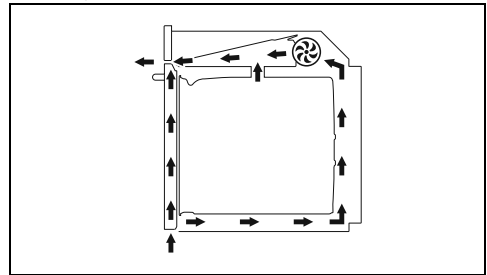

The fan cools the appliance and comes into operation during cooking.

The fan causes a steady outflow of air from above the door which may continue for a short period of time even after the appliance has been turned off.

## Oven cavity lighting

The appliance's interior lighting comes on:

- when the door is opened;
- when the  key on the display is pressed;
- when any function is selected, apart from the

 functions (depending on the models).

## Accessories

- Not all accessories are available on some models.
- The accessories intended to come into contact with food are made of materials that comply with the provisions of current

legislation.

- Original supplied and optional accessories can be requested to Authorised Assistance Centres. Use only original accessories supplied by the manufacturer.
- It is recommended to mount the pull-out slides on the first shelf of the frames. In this way, it is possible to optimise the space inside the oven cavity with an intermediate level between the first and the second shelf.



In this manual, suggestions for the second or middle shelf refer to the use of pull-out slides.

### Steel baking tray

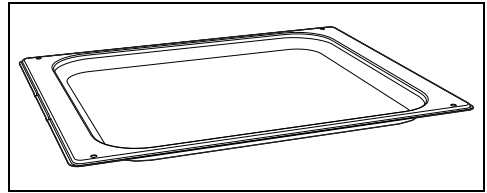

Useful when cooking cakes (with cooking times of less than 25 minutes or without steam), rice, beans and cereals. It is also essential for collecting liquids produced by steaming or defrosting foods contained in the perforated tray above.

### Funnel

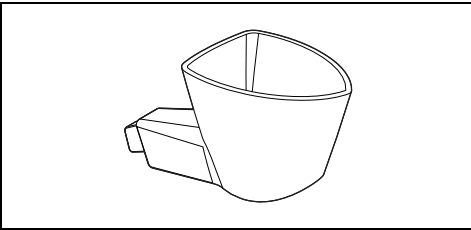

Used for filling the reservoir with water.

### Deep tray

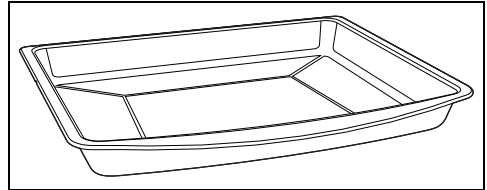

Useful for collecting fat from foods placed on the rack above and for cooking pies, pizzas, baked desserts, biscuits, etc.

### Lowered pan stand

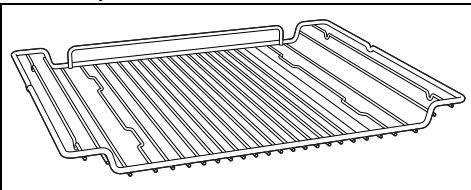

Used for supporting containers with food during cooking.

### Tray rack

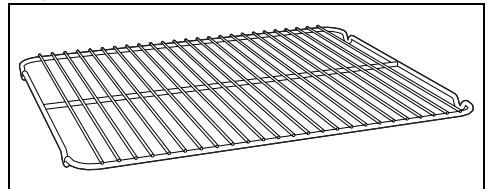

To be placed over the top of the tray; for cooking foods which may drip.

### Perforated tray

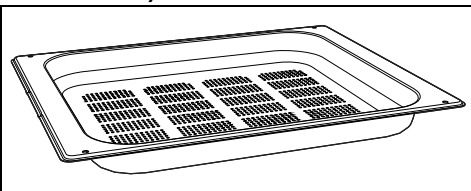

Useful for steaming fish and vegetables.

### Optional accessories (can be purchased separately)

#### Jug

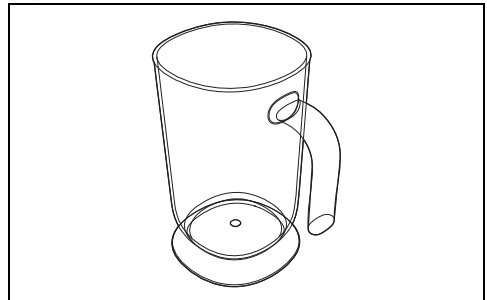

Useful for containing liquids during filling and emptying of the reservoir.

## PPR2 or STONE(refractory stone)

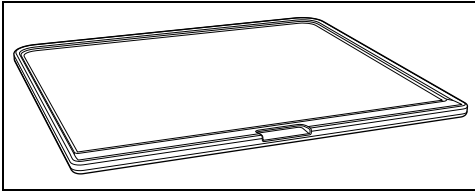

Ideal accessory for baking bread (pizza, bread, focaccia...), but you can also use it for more delicate preparations such as biscuits.

## BBQ (teflon-coated barbecue grill pan)

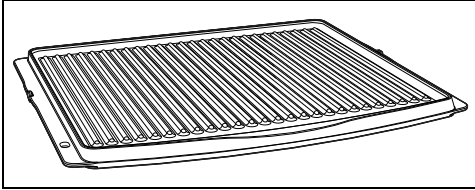

Double-use accessory: the striped side is recommended for grilling meat (fillets, hamburgers...), while the smooth surface can be used for cooking vegetables, fruit, fish...

## AIRFRY (oil-free frying grill)

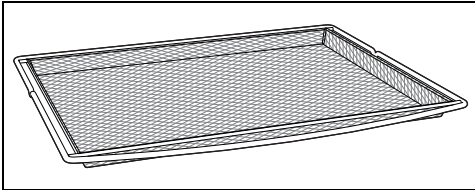

Recommended accessory for air-frying previously breaded, precooked and/or frozen food (chips, potato or meat croquettes, small mozzarella bites...).

## Advantages of steam cooking

The steam cooking system cooks any type of food much smoother and faster and finds its main applications for:

- Braising and stewing
- Cooking sauces

- Cooking au gratin
- Roasting
- Low temperature cooking
- Regenerating
- Multi-mode cooking

Variations in temperature and steam levels allow the wished gastronomic result to be achieved.

The addition of steam allows the use of less fat in favour of a healthier and more genuine cuisine. It also minimizes the loss of weight and volume in food while cooking.

Steam cooking is particularly suitable for cooking meat: in addition to making it very soft, it maintains it bright and makes it more succulent.

Also recommended for baking leavened and bread dough. The humidity in fact lets the dough grow and develop while cooking before creating the outer crust. The result is a lighter and more digestible dough, recognizable by thicker pockets.

It is also ideal for defrosting food rapidly, for heating up foods without hardening or drying them out, and for naturally removing salt from foodstuffs preserved with salt.

It is not recommended for short cooking times or for foods that may produce a large amount of moisture during cooking.

## Cooking containers

- You may also use your own containers for cooking, as long as they are resistant to high temperatures.
- For steam cooking, the use of metal containers is recommended. Metal facilitates better distribution of heat to the foods.
- It is normal for metal containers to deform somewhat during high-temperature cooking, but they will return to their original shape when they cool down.
- Thick ceramic plates may require more heat than normal. Longer cooking times may be necessary.

# USE

## Preliminary operations



See General safety instructions.

- Remove any protective film from the outside or inside of the appliance, including

accessories.

- Remove any labels (apart from the technical data plate) from the accessories and shelves.
- Remove and wash all the appliance accessories (see chapter "CLEANING

AND MAINTENANCE").

### First heating

1. Set a cooking time of at least one hour (see paragraph "Using the oven").
2. Heat the empty oven compartment at the maximum temperature to burn off any residues left by the manufacturing process.

When heating the appliance

- air the room;
- don't stay.

### Using the accessories

#### Racks and trays

Racks and trays have to be inserted into the side guides until they come to a complete stop.

- The mechanical safety locks that prevent the rack from being removed accidentally must face downwards and towards the back of the oven cavity.

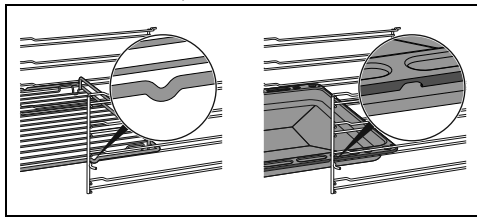

Gently insert racks and trays into the oven until they come to a stop.



Clean the trays before using them for the first time to remove any residues left by the manufacturing process.

#### Tray rack

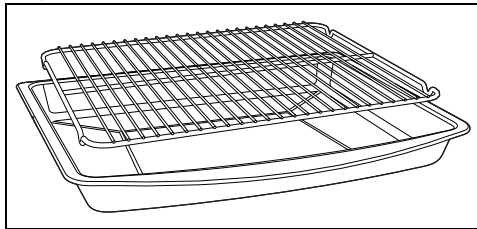

The tray rack has to be inserted into the tray. In this way fat can be collected separately from the food which is being cooked.

### Configuration for steam cooking

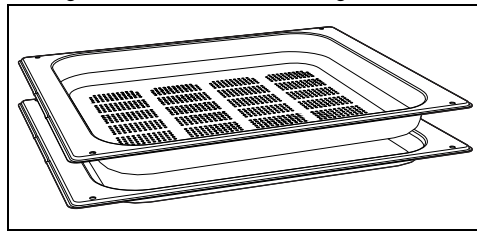

If you intend to use the perforated baking tray for steam cooking, it must be placed on the desired shelf taking care to place the steel baking tray on the shelf below. This allows liquids to be collected separately from the food which is being cooked.

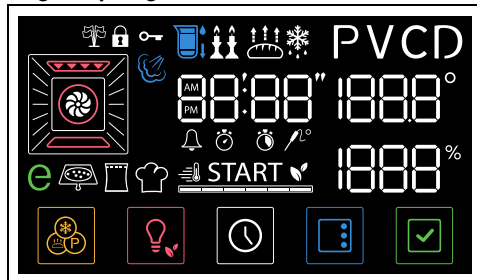

### Digital programmer





The parameters and values for the currently selected function will be indicated on the display. To use it, simply press the touch buttons on the control panel or press the buttons on the lower part of the display, depending on the operations to be performed by the appliance.

#### Touch buttons



The control panel is equipped with touch buttons that can be operated by lightly pressing on the symbol to be used.

- With the touch buttons  and  you can select the desired function and parameters (such as time or temperature, depending on the selected menu) within the display screen.







Press the  or  buttons continuously to scroll quickly through the parameters you want to change.

- Press the touch button  to exit the current function and return to the clock screen on the display.

- The touch buttons  and  can be used to increase or decrease the value of the selected parameter.



Press the  or  buttons continuously to modify quickly the value of the selected parameter.



- Press the touch button  to reset the selected parameter to the default value.
- To confirm the desired value, press the .

## First use





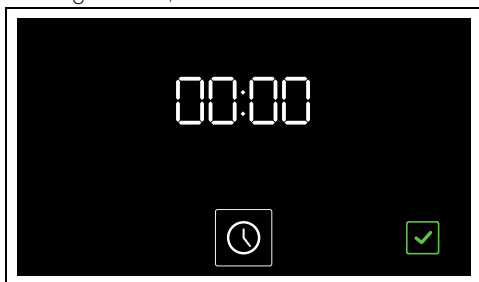

If the time is not set, the oven will not switch on.

On the first use, or after a long power failure,



 and the  button flash on the appliance display. To be able to start any cooking function, the current time must be set.









## Time setting

- Press the  button.
- With the  and  touch buttons select the clock format to display ( or .



When the version  is selected, the display shows  (morning) or  (afternoon).

- Press the  button to confirm the modification and go on to adjust the time.

- Press the  and  touch buttons to set the current time.
- Press the  button to set the current time and go to the selection of minutes.
- Press the  and  touch buttons to adjust the minutes of the current time.
- Press the  button to confirm.



It may become necessary to change the current time, for example for daylight saving time.



To cancel the operation, hold down the  button on the display for a few seconds.

## Modifying the time

- In the main menu, hold down the  button for a few seconds.

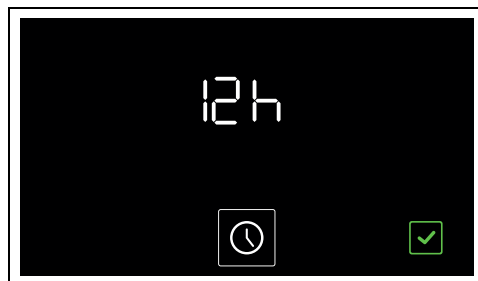

- Modify the time as described in point 2 in the previous chapter.

## Low brightness

After 2 minutes of inactivity, the display shows the  button and the current time in low brightness.

In this mode, the touch buttons on the control panel are disabled (the lighting is off and there

is no reaction to touching).



 The display only switches to low brightness mode if there is no heat inside the oven cavity.

### Reactivating the display

To activate the display and the touch buttons on the control panel:

- Hold down the  button on the display for about one second.





The display lights up and the touch buttons on the control panel come on.

### Using the oven

 See General safety instructions.

### Steam cooking

 If cooking has just been performed with temperatures greater than 100°C, you must wait for the oven to cool in order to use the steam function.

1. Press the  and  touch buttons on the control panel until you select the function with steam that you want to use (e.g.  + ). The indicator light  flashes.

### Reservoir filling

2. Open the door and pull the loading drawer out of its housing.

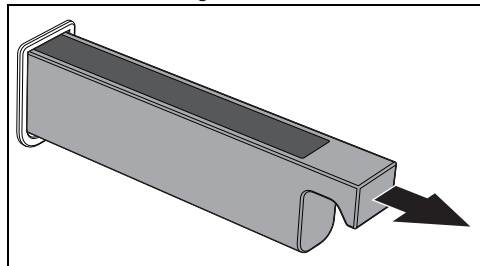

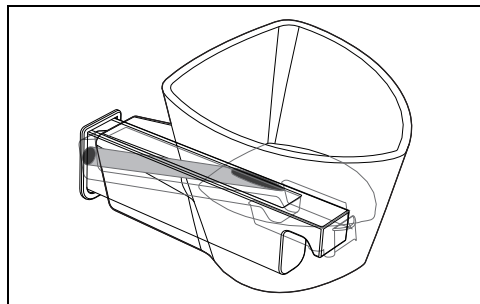

3. Insert the funnel provided in the loading drawer.

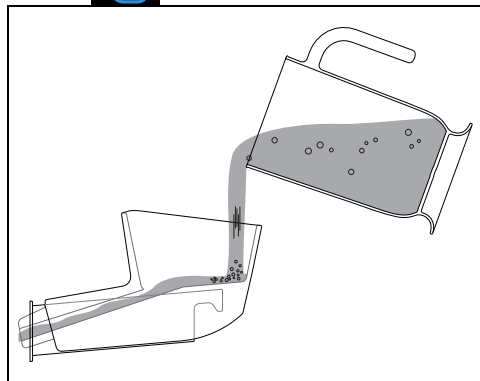

4. Pour the water (using a bottle or a measuring jug) until the max. level indicator light  comes on.



 Use cold tap water which is not too hard, softened water or still mineral water. Always use only drinking water.

 Do not use distilled water, tap water with a high chloride content (> 40 mg/l), or other liquids.

5. At the end, remove the funnel and place the loading drawer back in its place.

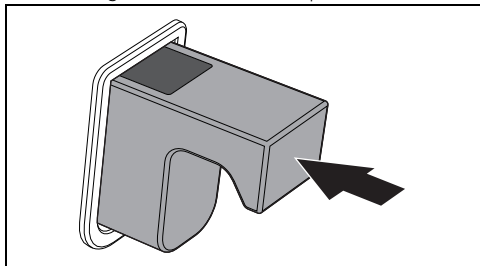



If there is too much water in the reservoir, the excess water will drain into the cooking compartment:

- in this case dry with a cloth or sponge before a cooking.
  - It is recommended to drain the 200 ml reservoir through the reservoir drain function.
6. Close the door.

the words **START** and the button  flash to indicate that the function can be started.

### Setting steam assisted cooking

1. Press the  and  touch buttons on the control panel to set the cooking temperature (from 30°C to 100°C) (e.g. "90°C").

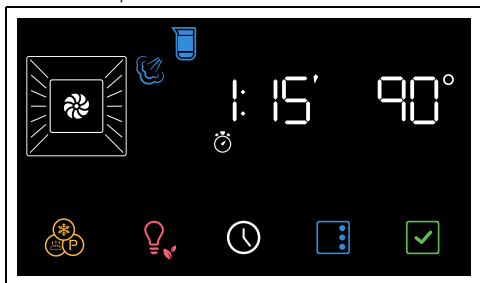

2. Press the  button.

The  and  indicator lights on the display flashes.

3. Press the  and  touch buttons on the control panel to set the cooking duration

(from 1 minute to 13 hours) (for example "1 hour").

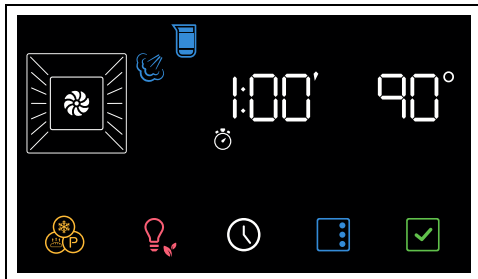

4. Press the  button to start the function.



When the door is opened, the function in progress is interrupted. The function resumes automatically when the door is closed.

### Preheating stage

Cooking itself is preceded by a preheating stage, which allows the appliance to heat to the cooking temperature more quickly.

This stage is indicated by the switching on of the indicator light  and by a progressive increase in the temperature level reached



Pre-heating cannot be bypassed when steam cooking is used.

At the end of preheating:

- the  indicator light switches off;
- the appliance beeps;
- cooking starts automatically.

### Cooking phase

1. Open the door
2. Place the dish with the food to be cooked into the oven cavity.
3. Close the door.

or

- If the dish with the food is already inside the oven cavity, press the  button to start cooking.
4. Check the cooking status of the food by turning on the internal light.

Cooking is indicated by the progressive decrease in time on the numerical display and the progressive decrease in the segment bar



## End of cooking

At the end of the cooking process an acoustic signal sounds and the display shows **End**.

1. Press the  touch button on the control panel to exit the function.
2. Open the door
3. Remove the dish from the oven cavity.
4. Close the door.

## Reservoir draining





Before draining the reservoir, wait for the oven to cool down, leaving the door open. To make sure that the water remaining in the reservoir is not too hot, wait at least 40 minutes.

After cooking:

1. Open the door
2. Place the deep pan on the second shelf from the bottom. Push it against the rear wall of the oven cavity.
3. From position 0, turn the function knob to the left by one position. The  button flashes.

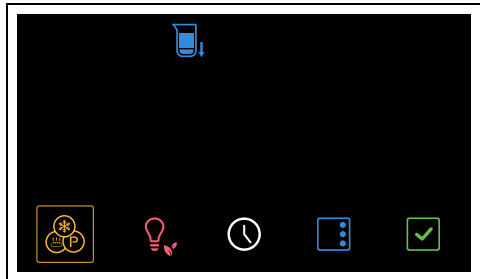
The appliance suggests the Drain reservoir function.



4. Press the  button to confirm the function.
5. Press the  button again to start the function.

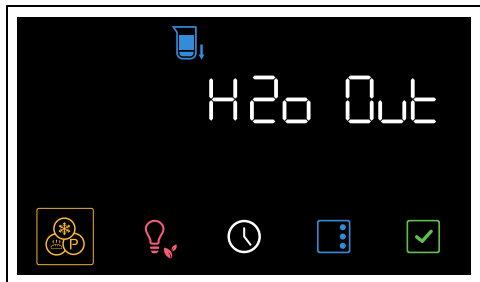

The water starts to flow into the deep pan from

the drain pipe on the right side of the rear wall of the oven cavity.

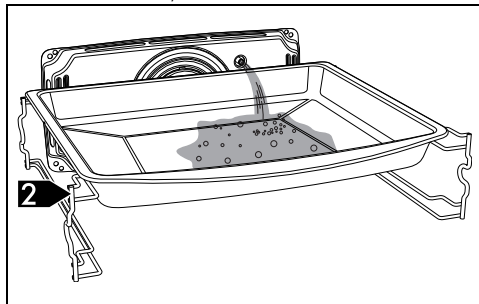

6. Wait for the end of the drain flow.  
At the end the appliance makes a beep and the display shows **End**.
7. Turn the function knob to position 0 to exit the function.



It is recommended to drain at the end of each cooking, to prevent any residue of unused water from remaining inside the reservoir.



After a long period of inactivity it is recommended to make a reservoir filling and draining cycle to rinse the steam circuit.

8. Drain the water from the deep pan.



Take care: the water may be very hot.



The drained water cannot be used for other cooking.

## Sous Vide cooking



### SOUS VIDE

Steam function for perfect cooking inside a sealed bag. The food's flavours are enhanced and no nutrients are lost.



The bag containing the food can be placed on the perforated tray or on a rack positioned on the first or second shelf.

Sous vide cooking in a steam oven is the best way to cook food without altering its nutritional properties and quality. It is also an extremely healthy and natural type of cooking.

- The Sous vide technique allows the heat to

be transferred efficiently from the steam to the food, preventing the loss of flavour through the oxidation and evaporation of nutrients and humidity during cooking.

- Sous vide cooking also allows greater control over the cooking compared to traditional methods and ensures that cooking is uniform.
- It also allows cooking to be carried out at lower temperatures compared to traditional cooking methods.

For Sous Vide cooking you need to:

- Have a chamber vacuum packing machine that allows you to achieve a better and safer vacuum for solid and liquid foods.
- Make sure that the seal area of the bag is clean and free from food residues.
- Hermetically seal the food in a special food grade bag that can withstand the cooking temperatures.
- Create a vacuum in the bag of at least 99.8% to prevent air bubbles forming inside that could affect the cooking.
- If you have a Smeg vacuum drawer, use the maximum vacuum level (level 3).

Once cooked, it is recommended to remove the product from the bag and finish cooking it in a pan or by grilling.





Tips:

- Preferably use fresh, high quality raw materials well-preserved until cooked.
- To improve the cooking result, dressings can be added inside the bag.
- Clean the food well from bones or fishbones that could pierce the bag and damage the cooking.
- Do not leave the food to be cooked for too long at room temperature as the bag may swell during cooking, losing all the advantages of vacuum.
- The food to be vacuum-packed for Sous Vide cooking or storage must be at a refrigerator temperature (from 3°C to 7°C), never hot.
- Keep the products in a vacuum (cooked and then blast chilled) at a constant temperature not exceeding 3°C in the refrigerator.
- For even cooking, do not overfill the bags and place the food in the best possible way on a single layer.
- If you are cooking multiple bags at the same time, place the bags on the same shelf

without overlapping them.

- Do not reuse the bags after cooking.

To select the Sous Vide cooking:

1. Press the  and  touch buttons on the control panel to select the  +  +  function.
2. For settings, see the procedure described in the "Steam cooking" section.

### Advice for steam cooking

- **Pasta and rice:** upon reaching 100°C, the cooking time will be the same as with cooking on a hob. Place the pasta or rice in a metal tray and cover with around a centimetre of water. For best results when cooking rice, place a lid on the container or cover with aluminium foil. This procedure allows the rice to absorb all the water, and it can then be served directly to the table.
- **Eggs:** these may be **boiled**, **scrambled** or **poached** by using the steam function at 100°C. To obtain perfect **boiled eggs**, place them on the perforated tray and cook for 4-6 minutes for soft boiled eggs and 8-10 minutes for hard-boiled eggs. For **scrambled eggs**, place the beaten eggs in a metal tray together with milk, butter and seasoning. Cover the tray with aluminium foil. Mix every couple of minutes using a fork. For **poached eggs**, pour boiling water into the metal tray with a drop of vinegar and steam cook for around 4-5 minutes.
- **Vegetables:** steam cooking vegetables gives excellent results. They maintain their colour, flavour and nutritional properties. For dense vegetables such as potatoes, turnips and parsnips, cook at 100°C for the same length of time you would boil them on a hob. For broccoli and carrots, cook for 6 minutes if you want them to remain firm, or 10 minutes if you want them to be softer.
- **Fish:** due to the delicate nature of fish, steaming gives excellent results. For oily fish such as salmon or trout, cook at 100°C for around 5 minutes. For white fish such as cod or haddock, cook at 80°C for around 5 minutes. If you are cooking different foods, all fish must be cooked in the perforated tray which must be placed on the bottom shelf of the oven to avoid liquid from the fish





dripping onto other food products.

- **Meat:** casseroles and curries are ideal for steam cooking. Prepare the casserole as for normal oven cooking. Place it in a metal tray, cover with a lid or aluminium foil, and cook for between 45 minutes and 3 hours depending on the cut of meat used.
- **Thin soups:** steam cooking allows flavours to develop perfectly with minimum effort, as the liquids will not boil over. For vegetable soup with the correct consistency, first steam the vegetables, then add broth and steam cook at 100°C. The steam function is also ideal for preparing large quantities for later use.
- **Soups:** Thicker soups are also easy and quick to prepare. Place the soup in a metal tray, cover with a lid or aluminium foil and steam cook at 100°F for the same time you would cook it in a microwave oven. To obtain a creamy texture stir halfway through cooking.
- **Reheating:** the steam cooking function will not dry foods out and gives a moister result. A previously prepared home-cooked meal, covered with aluminium foil, will take around 10-12 minutes to reheat. Ready meals will require approximately double the time indicated on the package.
- **Defrosting:** it is possible to use the steam function to defrost foods. Times vary, but defrosting with the steam cooking function takes around half the time necessary for covered foods left to defrost at room temperature.
- **Peeling peppers and tomatoes:** this is very easy to do when using the steam function. Use a knife to cut a small cross in the skin of the tomato, and steam cook for 1 minute. Peppers have tougher skin, and may require up to 4 minutes to soften it sufficiently for peeling.
- **Chocolate:** this can be melted using the steam cooking function. Place the chocolate in a metal tray, cover with aluminium foil and steam cook for 1 minute. Unlike other methods, chocolate is unlikely to burn in the steam oven.
- **Hot towels:** ideal for facial treatments, a close shave or for use after a meal, these are easy to prepare using the steam cooking function. Moisten a towel with water, roll it up and steam it for 1 minute.



## Combination cooking with steam



25% - Cakes and bread  
30% - Duck  
40% - Beef, veal and lamb  
50% - Chicken  
70% - Whole fish



1. Press the  and  touch buttons on the control panel until you select the function with steam that you want to use (e.g.  + ). The indicator light  flashes.
2. Proceed with reservoir filling as described above.

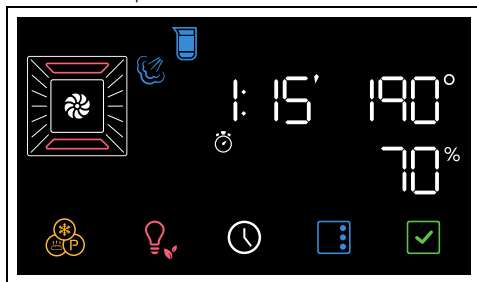

## Setting combined steam cooking

1. Press the  and  touch buttons on the control panel to set the cooking temperature (from 100°C to 250°C) (e.g. "190°C").





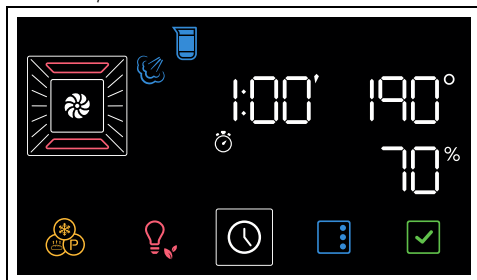

2. Press the  button.

The  and  indicator lights on the display flashes.

3. Press the  and  touch buttons on the control panel to set the cooking duration (from 1 minute to 13 hours) (for example "1 hour").



- Press the  button on the display. The indicator light  flashes.
- Press the  and  touch buttons on the control panel to set the cooking steam percentage (from 20% to 70%) (e.g. "40%").

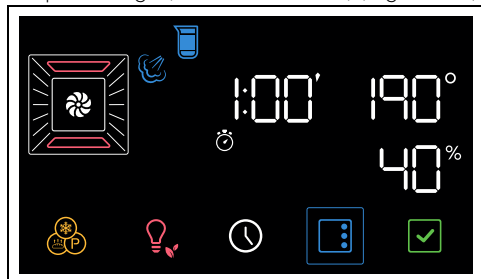

- Press the  button to start the function.



 When the door is opened, the function in progress is interrupted. The function resumes automatically when the door is closed.

### Preheating stage



Cooking itself is preceded by a preheating stage, which allows the appliance to heat to the cooking temperature more quickly.

This stage is indicated by the switching on of the indicator light  and by a progressive increase in the temperature level reached



 You can skip the preheating phase by holding down the  button for a few seconds.

At the end of preheating:

- the  indicator light switches off;
- the appliance beeps;
- the words **START** and the  button flash to indicate that the food can be introduced into the oven cavity.

### Cooking phase

- Open the door
  - Place the dish with the food to be cooked into the oven cavity.
  - Close the door.
- or
- If the dish with the food is already inside the oven cavity, press the  button on the

display to start cooking.

- Check the cooking status of the food by turning on the internal light.

### End of cooking

- Press the  touch button on the control panel to exit the function.
- Proceed with draining the reservoir as described above.

### Drying after steam functions

Cooking with steam generates a lot of moisture inside the appliance. This is a normal phenomenon and does not affect the appliance's operation in any way.

Each time you finish cooking:

- let the appliance cool down;
- thoroughly dry the oven cavity and the accessories used with a soft cloth or paper towels;
- leave the door open until the inside of the appliance has dried completely.

### List of combined cooking functions



#### FAN ASSISTED+STEAM

 Intense and uniform cooking. The addition of steam allows better preservation of the properties of the food. Ideal for roast veal, roast duck and cooking whole fish.

#### FAN-ASSISTED STEAM

 The addition of steam to cooking with the fan assisted circulaire element allows better preservation of the properties of the food. Ideal for preparing roasts, chicken and baked goods like leavened cakes and bread.

### Traditional cooking

 Cooking can be interrupted at any time by pressing and holding the  touch button.

- Use the  and  touch buttons to select the desired function (e.g. "FAN-ASSISTED ").

The  button and the text **START** on the display start flashing.

2. Press the  and  touch buttons to set the desired temperature (e.g. "200°C").

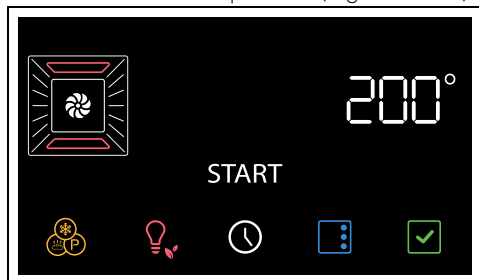

3. Press the  button to start the function.



 When the door is opened, the function in progress is interrupted. The function resumes automatically when the door is closed.

### Preheating stage



Cooking itself is preceded by a preheating stage, which allows the appliance to heat to the cooking temperature more quickly.

This stage is indicated by the switching on of the indicator light  and by a progressive increase in the temperature level reached



 You can skip the preheating phase by holding down the  button for a few seconds.

At the end of preheating:

- the  indicator light switches off;
- the appliance beeps;
- the words **START** and the  button flash to indicate that the food can be introduced into the oven cavity.

### Cooking phase

1. Open the door
  2. Place the dish with the food to be cooked into the oven cavity.
  3. Close the door.
- or
- If the dish with the food is already inside the oven cavity, press the  button on the display to start cooking.
4. Check the cooking status of the food by turning on the internal light.



### End of cooking



5. Press the  touch button on the control panel to exit the function.

### Timed cooking

 Timed cooking is the function which allows a cooking operation to be started and then ended after a specific length of time set by the user.

1. After selecting a cooking function and temperature, press the  key.

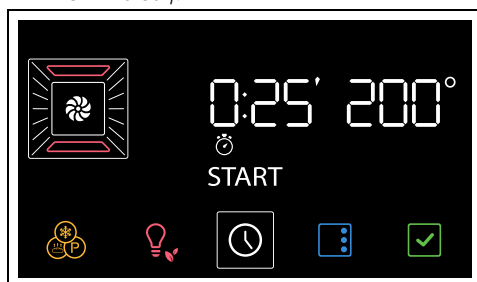

The  and  indicator lights on the display flashes.

2. Press the  and  touch buttons on the control panel to set the cooking duration (from 1 minute to 13 hours) (for example "25 minutes").



3. Press the  button on the display to confirm the cooking duration.

 Bear in mind that a few minutes for oven preheating must be added to the cooking time.

4. Press the  button to start the function.
- At the end of preheating:
5. Place the food inside the oven cavity.
  6. Press the  button to start cooking.



Timed cooking is indicated by the progressive decrease in time on the numerical display and the progressive decrease in the segment bar



At the end of the cooking process an acoustic signal sounds and the display shows **End**.

7. Press the  touch button on the control panel to exit the function.

## To delete a timed cooking

1. Press the  button for a few seconds on the display.
2. Press the  touch button on the control panel to reset the cooking time.
3. Press the  button to confirm.

## Programmed cooking







Programmed cooking is the function which allows a time-controlled cooking operation to be stopped at an established time depending on the time set by the user, after which the appliance will switch off automatically.



For safety reasons, it is not possible to set the end of cooking time by itself without setting the cooking duration.

1. After selecting a cooking function and temperature, press the  key.

The  and  indicator lights on the display flashes.

2. Press the  and  touch buttons on the control panel to set the cooking duration (from 1 minute to 13 hours) (for example "25 minutes").

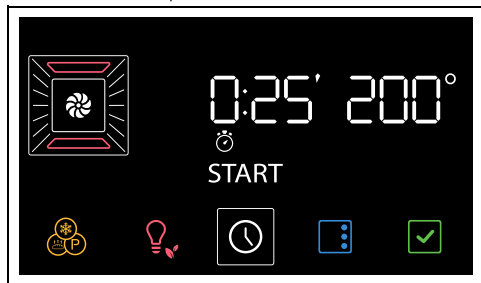



3. Press the  button.

The  and  indicator lights on the display flashes.

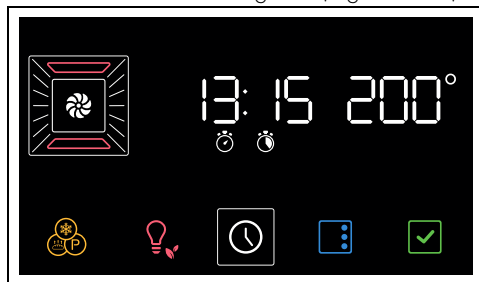
4. Press the  and  touch buttons to set the end-of-cooking time (e.g. "13:15").



5. Press the  button to confirm end-of-cooking time.
6. Press the  button to start the function. The appliance waits for the set start time.





The minutes required for preheating are already included in the end-of-cooking time.

At the end of the cooking process an acoustic signal sounds and the display shows .



7. Press the  touch button on the control panel to exit the function.



## To delete a programmed cooking

1. Press the  button for a few seconds.

The  and  indicator lights on the display flashes

2. Press the button  shortly.

The  and  indicator lights on the display flashes.

3. Press the  touch button on the control panel to reset the cooking time.
4. Press the  button to confirm.



In this way, only the programmed cooking is cancelled. Timed cooking starts immediately with the preheating phase.

## Minute minder timing during a cooking process



The minute minder timer does not stop the cooking operation but rather informs the user when the set time has run out.

1. Press the  button.

The  and  indicator lights on the display flashes.

2. Press the  button.

The display shows  and the indicator light  flashing.

3. Press the  and  touch buttons on the control panel to set the duration of the minute minder (from 1 minute to 13 hours).

4. Press the  button to confirm.

At the end of the minute minder timer, an acoustic signal sounds and the indicator light  flashes on the display.

5. Press the  button to quit the function.

## List of traditional cooking functions



Not all functions are available on some models.

### STATIC



Traditional cooking suitable for the preparation of one dish at a time. Ideal for cooking roasts, fatty meats, bread, pies.

### FAN ASSISTED



Intense and uniform cooking. Ideal for biscuits, cakes and multilevel cooking.

### CIRCULAIRE



The heat is distributed quickly and uniformly. Suitable for all dishes, ideal for cooking on multiple levels without mixing smells or flavours.

### GRILL



It allows to obtain excellent grilling and grating results. Used at the end of cooking, it gives a uniform browning to the dishes.

### BOTTOM HEAT



The heat comes from the bottom of the cavity. Perfect for cakes, pies, tarts and pizzas.

### ECO



This function is particularly suitable for cooking on a single shelf with low energy consumption.

It is recommended for all types of food, excluding those that can create a lot of humidity (such as vegetables).

To obtain maximum energy savings and reduce cooking times, it is recommended to place food in the oven without preheating.



When using the ECO function, avoid opening the door during cooking.



Cooking (and preheating) times are longer with the ECO function and may depend on the amount of food in the oven.



The ECO function is a delicate cooking function and is recommended for food withstanding temperatures lower than 210°C; in case of cooking at higher temperatures, select another function.

## Cooking advice

### General advice

- Use a fan-assisted function to achieve consistent cooking at several levels.
- It is not possible to shorten cooking times by increasing the temperature (the food could be overcooked on the outside and undercooked on the inside).

### Advice for cooking meat

- Cooking times vary according to the thickness and quality of the food and to consumer taste.
- Turn the food to brown both sides.
- Use a meat thermometer when roasting meat, or simply press on the roast with a spoon. If it is hard, it is ready; If not, it needs another few minutes cooking.

### Advice for cooking with the Grill

- Meat can be grilled even when it is put into the cold oven or into the preheated oven if you wish to change the effect of the

cooking.

- When using the fan-assisted with grill function(if any), we recommend that you preheat the oven before grilling.
- We recommend placing the food at the centre of the rack.
- With the Grill function, we recommend that you set the temperature to the maximum value to optimise cooking.

### **Advice for cooking desserts/pastries and biscuits**

- Use dark metal moulds: They help to absorb the heat better.
- The temperature and the cooking time depend on the quality and consistency of the dough.
- To check whether the dessert is cooked right through: At the end of the cooking time, put a toothpick into the highest point of the dessert. If the dough does not stick to the toothpick, the dessert is cooked.
- If the dessert collapses when it comes out of the oven, on the next occasion reduce the set temperature by about 10°C, selecting a longer cooking time if necessary.

### **Advice for cooking with two shelves:**

- We suggest to arrange two racks (they can be requested to Authorised Service Centres).
- To facilitate the air flow, place the moulds/casseroles in the centre of the racks and make sure that their width/diameter does not exceed 30 cm.
- Place the racks leaving one free shelf between them.
- Depending on the food and the increased load inside the cavity, cooking on two levels may take a few minutes longer than on a single shelf.
- The functions indicated for cooking on two shelves are THERMALLY-VENTILATED and THERMALLY-VENTILATED BASE.

### **Advice for steam cooking**

- For bread-type products (bread, focaccia, etc.) and frozen desserts, where steam is useful during the first few minutes of cooking, we recommend setting a steam function for the first 5-10 minutes and then switching to ventilated mode to complete cooking.
- For steam heating insert in a cold oven.

### **Advice for defrosting and proving**

- Place frozen foods without their packaging in a lidless container on the first shelf of the oven.
- Avoid overlapping the food.
- To defrost meat, use the rack placed on the second level and a tray on the first level. In this way, the liquid from the defrosting food drains away from the food.
- The most delicate parts can be covered with aluminium foil.
- For successful proving, a container of water should be placed in the bottom of the oven.

### **To save energy**

- Stop cooking a few minutes before the time normally used. Cooking will continue for the remaining minutes with the heat which has accumulated inside the oven.
- Reduce any opening of the door to a minimum to avoid heat dispersal.
- Keep the inside of the appliance clean at all times.

## Mini guide to accessories



Perforated tray

Use the perforated tray on the pull-out slides mounted on the first shelf from the bottom. Place the steel tray on the level below.

It is suitable for steam and combination steam and cooking.



Rack

We recommend the use of the grill as a support surface for baking moulds/casseroles.

In the absence of the baking tray grill, the grill can be used as a base for grilling with the deep baking tray placed on a shelf below to collect the juices.



Deep tray

We recommend the use of the deep baking tray for cooking on one level only.

Place the deep tray on the first shelf (or on the middle shelf with the sliding rails mounted on the first shelf) when using the static and fan-assisted functions.



Tray rack

We recommend using the baking tray grill as a base to collect the juices from the grills.

Place the baking tray on the last shelf with the baking tray grill to cook in GRILL mode.



## Discover the recipes

To consult the recipes developed for various categories of food and to get more information on cooking suggestions, we recommend visiting the dedicated page on the [www.smeg.com](http://www.smeg.com) website, which can be reached using the QR code on the leaflet supplied with the product.

## Information for Supervisory Bodies

### Fan forced mode

The ECO function used to establish the energy efficiency class is compliant with the specifications of European standard EN 60350-1.

See the "To save energy " section in the INSTRUCTIONS chapter.

### Conventional heating mode



To use the STATIC mode, you have to skip the preheating stage (see the section "Preheating stage" in the USE chapter).

See the "To save energy " section in the INSTRUCTIONS chapter.



## Special functions

- On the display, press the  button.



To scroll through the available functions, press the  and  touch buttons until the desired special function is selected.





To exit the selected function (not yet started), press and hold the  button on the control panel or the  button on the display.

## DEFROSTING





This function allows you to defrost food on the basis of a selectable time.

- After entering the special functions menu, press the  and  touch buttons on the control panel until the  function is selected.



If the indoor temperature is higher than expected, the function is not activated and every time the  button is pressed the appliance makes a beep. Let the appliance cool down before activating the function.

- Open the door.
- Place the food to be defrosted inside the oven.
- Close the door.
- Press the  button to confirm.
- Press the  and  touch buttons on the control panel to set the defrosting

duration (from 1 minute to 13 hours) (for example "1:30").



5. Press the button to confirm.

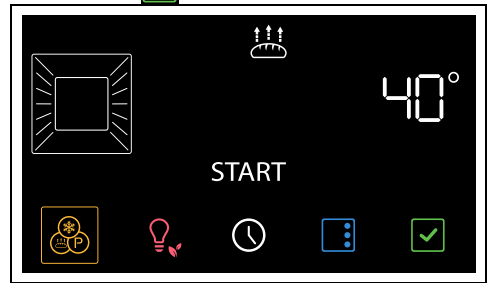

7. Press the button to start the function.

At the end, **End** is displayed and flashes and a beep is activated.

8. Press the touch button on the control panel to exit the function.

9. Below is a reference table with defrosting times by type of food.

Type	Weight (kg)	Time
Meats	0.5	1h 45m
Fish	0.4	0h 40m
Bread	0.3	0h 20m
Desserts	1.0	0h 45m

6. Press the and touch buttons on the control panel to modify the temperature value (from 25°C to 40°C).

7. Press the button to start the function.

8. Press the touch button on the control panel to exit the function.

For successful proving, a container of water should be placed in the bottom of the oven.

## PROVING

This function is particularly suitable for proving dough.

1. After entering the special functions menu, press the and touch buttons until the function is selected.

If the indoor temperature is higher than expected, the function is not activated and every time the button is pressed the appliance makes a beep. Let the appliance cool down before activating the function.

2. Open the door.
3. Position the dough to prove on the second level.
4. Close the door.

## SABBATH

This function results in the appliance operating in a particular way:

- Cooking can proceed indefinitely, it is not possible to set any cooking duration.
- No pre-heating will be performed.
- The cooking temperature which can be selected varies between 60-150°C.
- Oven light disabled, any operation such as opening the door (where present) or manual activation will not activate the light.
- The internal fan remains turned off.
- Touch buttons and audible prompts are disabled.

After activating the Sabbath mode the settings cannot be altered. Any action on the control panel touch buttons and/or display buttons will have no effect.



1. After entering the special functions menu, press the and touch buttons on the control panel until the function is selected.
2. Press the button to confirm.

- Press the  and  touch buttons on the control panel to set the desired temperature (e.g. "90°C").







- Press the  button to start the function.

To exit the function:

- Press the  button for a few seconds on the display.
- When the control panel is reactivated, press the  touch button to end the function.

## TURBO

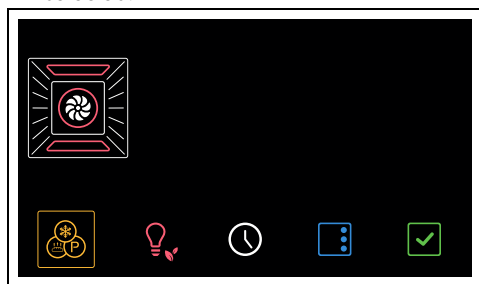

 Allows quick cooking on multiple shelves without mixing the aromas. Perfect for large volumes that call for intense cooking.

- After entering the special functions menu, press the  and  touch buttons on the control panel until the  function is selected.

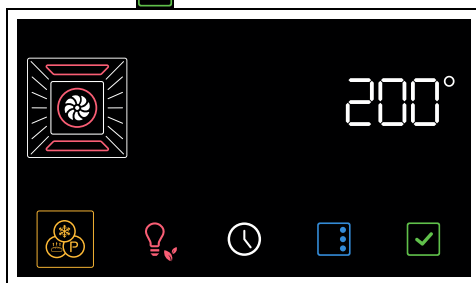

- Press the  button to confirm.





- Press the  and  touch buttons on the control panel to select the required temperature (from 50°C to 250°C).
- Press the  button to start the function.

 As with normal cooking functions, you can skip pre-heating and set a timed and programmed cooking.

- After preheating, open the door and place the food to be cooked in the oven cavity.
- Close the door.
- Check the cooking status of the food by turning on the internal light.
- Press the  touch button on the control panel to exit the function.

## PIZZA

 Function designed for cooking pizza. Perfect not just for pizzas, but also for biscuits and cakes.

- After entering the special functions menu, press the  and  touch buttons on the control panel until the  function is selected.

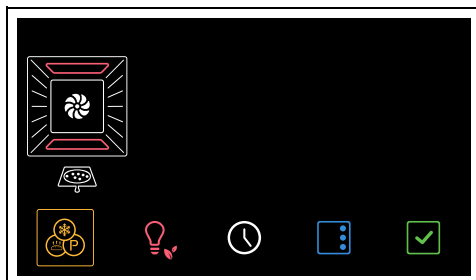

- Press the  button to confirm.

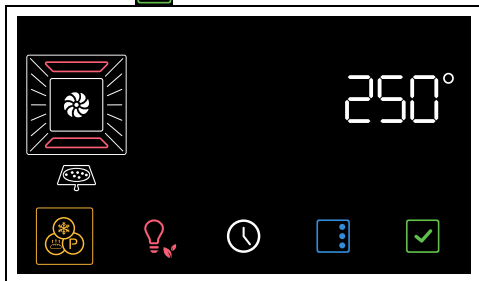



- Press the  button to start the function.



 In this function it is not possible to skip the preheating phase.

- After preheating, open the door and place the food to be cooked in the oven cavity.
- Close the door.
- Check the cooking status of the food by turning on the internal light.
- Press the  touch button on the control panel to exit the function.

## STONE

 Useful for on stone cooking. For use with the PPR2 or STONE accessory sold separately.

 Please refer to the instructions and recommendations for use described in the accessory documentation.



- Open the door.
- Insert the PPR2 or STONE accessory into the oven cavity (refer to the specific accessory manual).
- Close the door
- After entering the special functions menu, press the  and  touch buttons on

the control panel until the  function is selected.



- Press the  button to confirm.





- Press the  and  touch buttons on the control panel to select the required temperature (from 50°C to 280°C).
- Press the  button to start the function.

 As with normal cooking functions, you can skip pre-heating and set a timed and programmed cooking.



- After preheating, open the door and place the food to be cooked on the accessory.
- Close the door.
- Press the  touch button on the control panel to exit the function.

## BBQ (Barbecue)

 Useful for barbecue cooking. For use with the BBQ accessory sold separately.

 Please refer to the instructions and recommendations for use described in the accessory documentation.

- Open the door.
- Insert the BBQ accessory into the oven cavity.
- Close the door

4. After entering the special functions menu, press the  and  touch buttons on the control panel until the **bb9** function is selected.

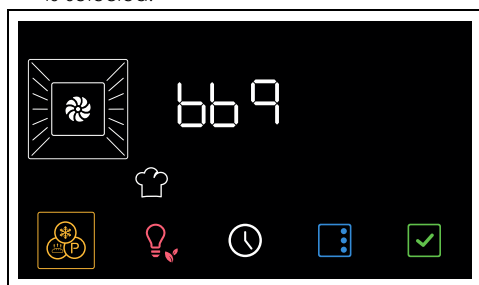

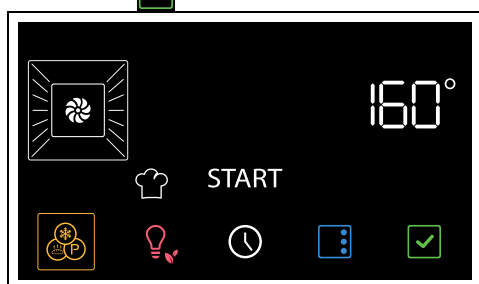

5. Press the  button to confirm.



6. Press the  and  touch buttons on the control panel to select the required temperature (from 50°C to 250°C).

7. Press the  button to start the function.



 As with normal cooking functions, you can skip pre-heating and set a timed and programmed cooking.

8. After preheating, open the door and place the food to be cooked on the accessory.  
9. Close the door.  
10. Press the  touch button on the control panel to exit the function.

## AIRFRY

 Useful to obtain fried cooking without oil. For use with the AIRFRY accessory sold separately.

 Please refer to the instructions and recommendations for use described in the accessory documentation.

1. After entering the special functions menu, press the  and  touch buttons on the control panel until the **FrY** function is selected.

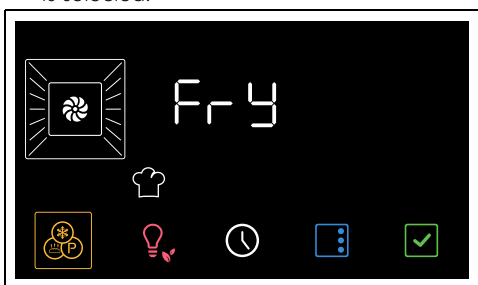

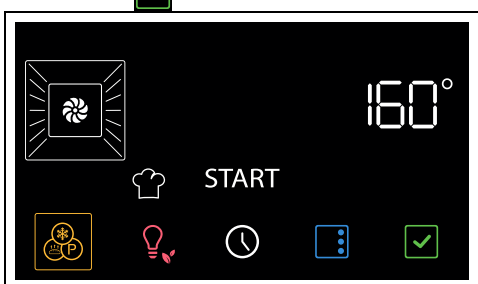

2. Press the  button to confirm.



3. Press the  and  touch buttons on the control panel to select the required temperature (from 50°C to 250°C).

4. Press the  button to start the function.

 As with normal cooking functions, you can skip pre-heating and set a timed and programmed cooking.



5. When preheating is complete, open the door and insert the AIRFRY accessory with the food to be cooked into the oven cavity.  
6. Close the door.  
7. Press the  touch button on the control panel to exit the function.

## Secondary functions







The buttons at the bottom of the display have some secondary functions:

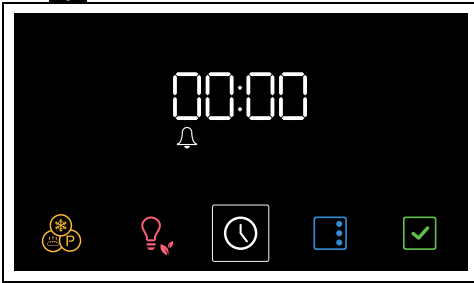

### MINUTE MINDER TIMER

 The minute minder timer only warns the user that the preset number of minutes has passed.

1. Press the  button on the main menu.  
The display shows  and the indicator light  flashing.





4. Press the  and  touch buttons to set the current time.
5. Press the  button to set the current time and go to the selection of minutes.
6. Press the  and  touch buttons to adjust the minutes of the current time.
7. Press the  button to confirm.

 To cancel the operation, hold down the  button for a few seconds.



## Settings

- Press the  button on the main menu.





 To quit the settings menu, hold down the  button for a few seconds.

## Control lock (children safety)

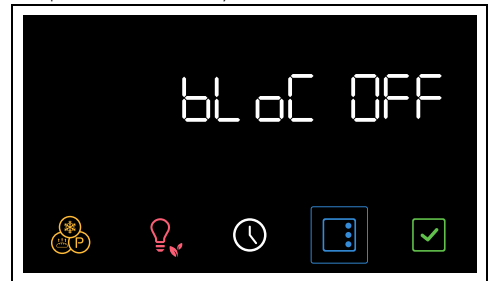
 This mode allows the appliance to lock the controls automatically after 2 minutes of normal operation without any intervention from the user.

1. After entering the setting menu, press the  and  touch buttons on the control panel until the KeyLock function is selected.









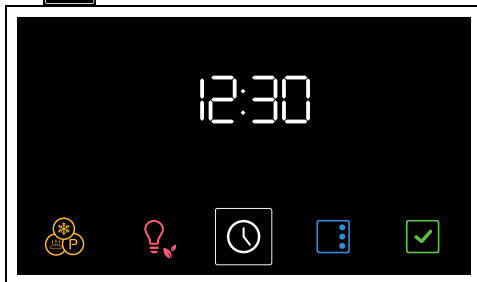

2. Press the  and  touch buttons on the control panel to set the duration of the minute minder (from 1 minute to 13 hours).
3. Press the  button to confirm.
4. At the end of the minute minder timer, an acoustic signal sounds and the indicator light  flashes on the display.
5. Press the  button to quit the function.

## TIME

1. In the main menu, hold down the  button for a few seconds.



2. Press the  and  touch buttons on the control panel to select the clock format to display ( or ).



 When the version  is selected, the display shows  (morning) or  (afternoon).

3. Press the  button to confirm the modification and go on to adjust the time.

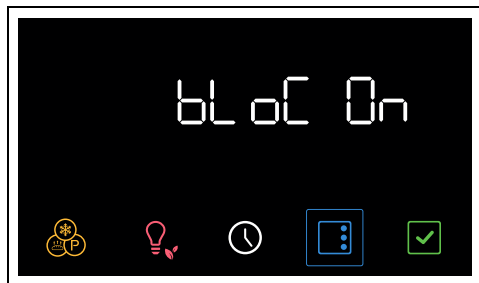
- Press the  and  touch buttons on the control panel to start the KeyLock function.



- Press the  button to confirm.

 In normal operation, the control lock is indicated by the  indicator light coming on.

 Touching the display or control panel buttons, the display will show **Loch** for two seconds.

To temporarily release the lock:

- during a cooking process, press a button on the display.





- When the display shows the "Lock On" screen, press the  button for a few seconds.

Two minutes after the last setting the lock will become active again.

### Showroom (for showrooms only)

 This mode allows the appliance to deactivate all heating elements, while keeping the control panel active.

- After entering the setting menu, press the  and  touch buttons on the control

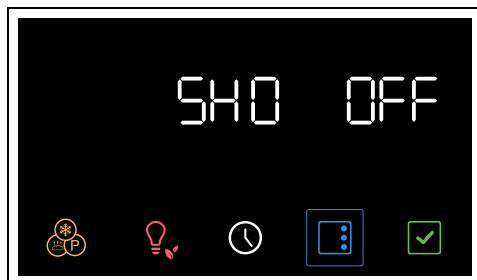

panel until the Showroom function is selected.

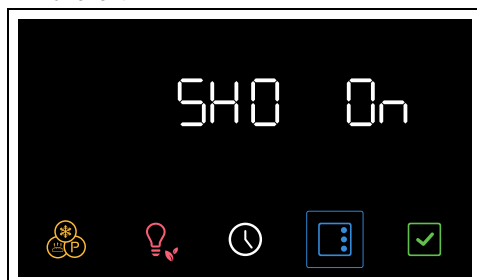

- Press the  and  touch buttons on the control panel to start the Showroom function.





- Press the  button to confirm.



 The activated showroom is indicated on the display by the  indicator light on.

 To use the appliance normally, set this function to OFF.

### Water hardness

 This mode allows you to set the water hardness value in order to optimise the descaling process.

 The appliance is factory set for water of medium hardness (3).

- After entering the setting menu, press the  and  touch buttons on the control

panel until the water hardness function is selected.

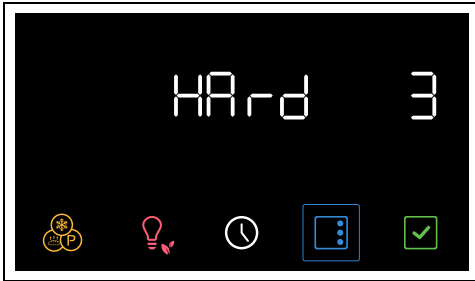

- Press the and touch buttons on the control panel to set water hardness (values from 1 to 5) (for example "1").

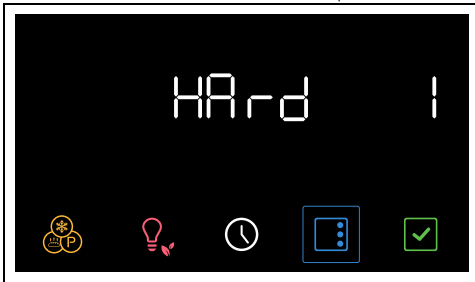

- Press the button to confirm.

If your mains water supply is too hard, we recommend using a water softener.

Request information on the hardness of your water from your local water board.

Depending on the degree of water hardness (°dH or °dF), the number of hours after which descaling is required is as follows:

Value	°dH	°dF	Hours
1	0 - 8	0 - 15	8
2	8 - 14	15 - 25	7
3	14 - 21	25 - 38	6
4	21 - 38	38 - 53	5
5	31 - 50	54 - 90	4

## Keep warm

This mode allows the appliance after cooking finishes with a cooking cycle for which a duration has been set (if this is not manually interrupted), to keep cooked food warm (at low temperatures) without altering the taste and aromas obtained during cooking.

- After entering the setting menu, press the and touch buttons on the control panel until the Keep warm function is selected.

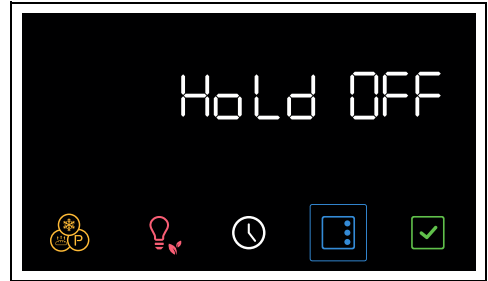

- Press the and touch buttons on the control panel to start the Keep warm function.

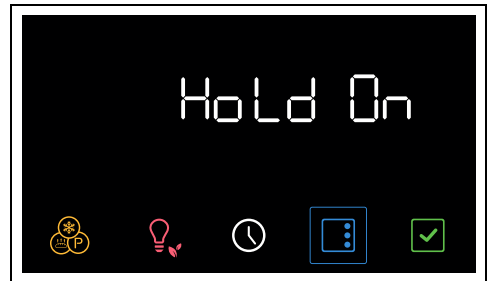

- Press the button to confirm.

To use the appliance normally, set this function to OFF.

## Display brightness

This mode allows the display brightness level to be selected.

- After entering the setting menu, press the and touch buttons on control

panel until the display brightness function is selected.



2. Press the and touch buttons on the control panel to select the desired brightness, from value 1 (low brightness) to value 5 (high brightness).
3. Press the button to confirm.

The display brightness function is factory set to high.

## Sound

Whenever one of the display symbols is pressed, the appliance beeps. This setting disables these sounds.

1. After entering the setting menu, press the and touch buttons on the control panel until Sound function is selected.

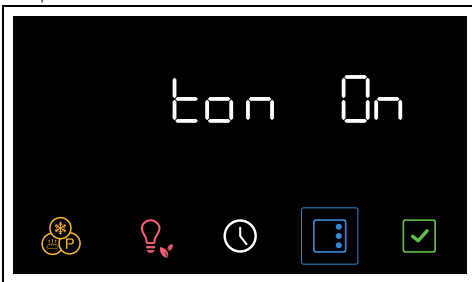

2. Press the and touch buttons on the control panel button to disable the sound associated with the touch of the symbols on the display.



3. Press the button to confirm.

## Other settings

### Eco light

For greater energy savings, the lights inside the oven cavity are automatically deactivated approximately one minute after the start of cooking or after the door is opened.

To stop the appliance from automatically deactivating the light after approximately one minute, set this mode to Off.

The Eco light function is factory set to On.

- To deactivate the Eco light function, press the key for a few moments.
- To reactivate the Eco light function, press the key for a few moments.

# CLEANING AND MAINTENANCE

## Cleaning the appliance

See General safety instructions.

### Cleaning the surfaces

To keep the surfaces in good condition, they should be cleaned regularly after use. Let them

cool first.

### Ordinary daily cleaning

Always and only use specific products that do not contain abrasives or chlorine-based acids. Pour the product onto a damp cloth and wipe the surface, rinse thoroughly and dry with a soft cloth or a microfibre cloth.

## Food stains or residues

Do not use steel sponges and sharp scrapers as they will damage the surface.

Use normal, non-abrasive products and a wooden or plastic tool, if necessary. Rinse thoroughly and dry with a soft cloth or a microfibre cloth.

Do not allow residues of sugary foods (such as jam) to set inside the oven. If left to set for too long, they might damage the enamel lining of the oven.

## Cleaning the door

### Door disassembly

For easier cleaning it is recommended to remove the door and place it on a tea towel.

To remove the door proceed as follows:

1. Open the door completely and insert two pins into the holes on the hinges indicated in the figure.

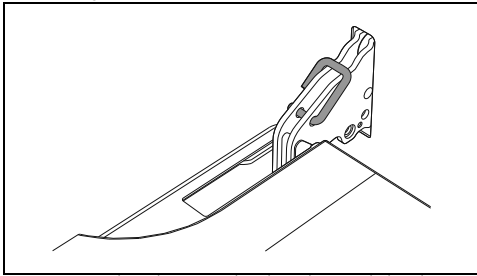

2. Grasp the door on both sides with both hands, lift it forming an angle of around 30° and remove it.

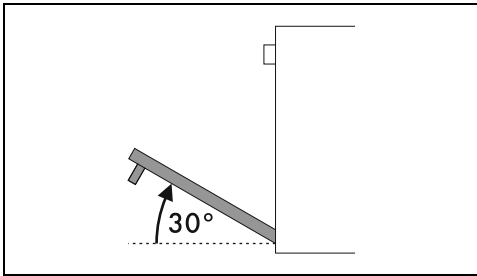

3. To reassemble the door, put the hinges in the relevant slots in the oven, making sure

that grooved sections **A** are resting completely in the slots.

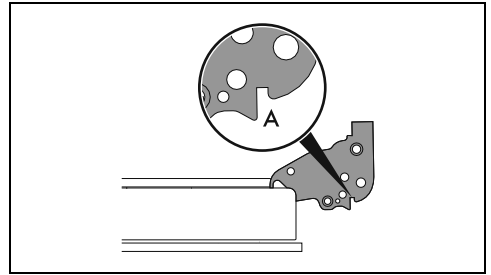

4. Lower the door and once it is in place remove the pins from the holes in the hinges.

### Cleaning the door glazing

The glass in the door should always be kept thoroughly clean. Use absorbent kitchen roll. In case of stubborn dirt, wash with a damp sponge and an ordinary detergent.

### Removing the internal glass panes

For easier cleaning the internal glass panes of the door can be removed.

1. Lock the door with the appropriate pins.
2. Remove the internal glass pane by pulling the rear part gently upwards, following the movement indicated by the arrows 1.

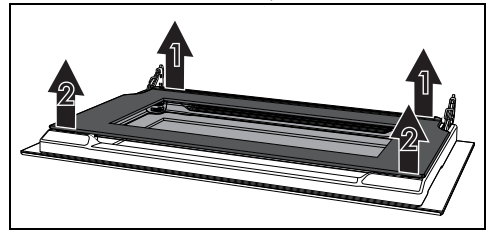

3. Release the front pins following the movement indicated by the arrows 2
4. Then remove the internal glass pane from the door.

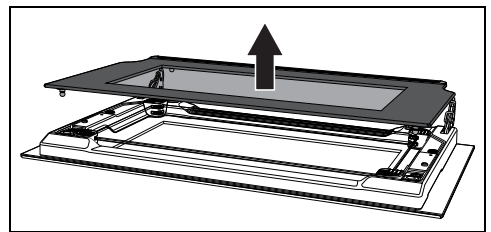

5. Pull the intermediate glass unit downwards from the door and then lift it upwards.

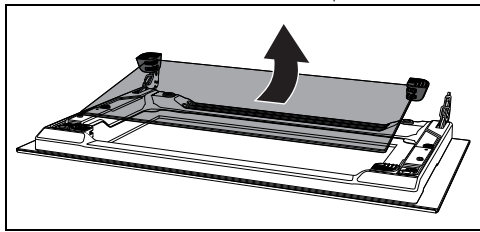

Note: In some models, the intermediate glass unit consists of two panes.  
 During this step, the upper grommets may come out of their seats.

6. Insert the front grommets into their seats. The feet of the grommets must be facing the outer glass

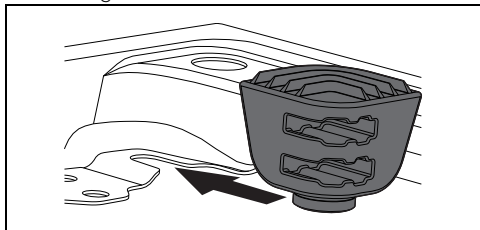

7. Clean the external glass pane and the panes removed previously.

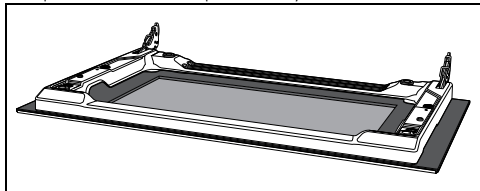

8. Use absorbent kitchen roll. In case of stubborn dirt, wash with a damp sponge and neutral detergent.

9. Reinsert the intermediate glass unit and reposition the inner glass.

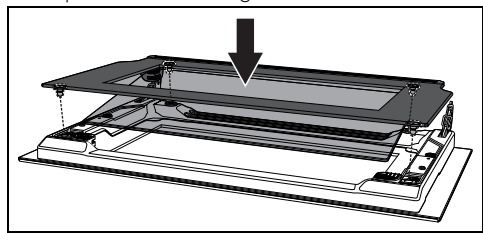

The intermediate glass pane must be repositioned on the open door so that the screen printing in the corner can be read from left to right (the rough part of the screen printing must face the external glass pane of the door).

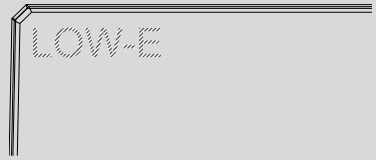

The intermediate glass pane must be housed in the upper recess of each grommet.

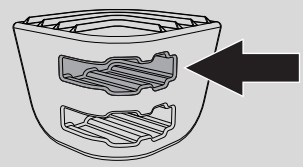

10. Be sure to fit the 4 pins of the inner glass well into their seats on the door.

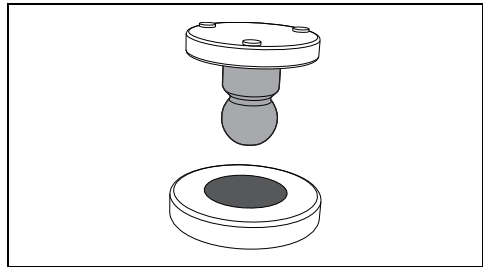

### Cleaning the oven cavity

In order to keep your oven in the best possible condition, clean it regularly after letting it cool down.

Avoid letting food residue dry inside the oven cavity, as this could damage the enamel. Take out all removable parts before cleaning.

For easier cleaning, it is recommended to remove:

- the door;
- The rack/tray support frames.



In the event you are using specific cleaning products, we recommend running the oven at maximum temperature for 15-20 minutes in order to eliminate any residue.

## Drying

Cooking food generates moisture inside the appliance. This is a normal phenomenon and does not affect the appliance's operation in any way.

Each time you finish cooking:

1. Let the appliance cool down.
2. Remove any dirt from inside the appliance.
3. Dry the interior of the appliance with a soft cloth.
4. Leave the door open until the inside of the appliance has dried completely.

## Removing rack/tray support frames

Removing the rack/tray support frames enables the sides to be cleaned more easily.

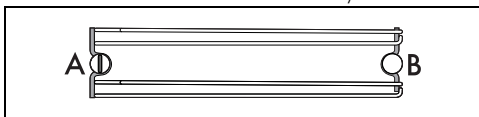

A = front housing

B = rear pin



In some models, the rear pin B can be removed and re-assembled in the same way as the front housing A.



To remove the rack/tray support frames:

1. Unscrew the front fixing pin located on the side wall near the opening of the oven cavity (you can help yourself with a tool, e.g. a coin).

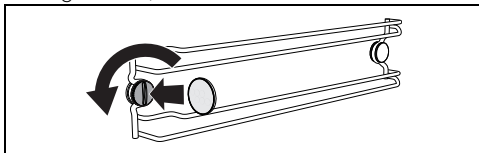

2. Carefully pull the frame towards the inside of the oven cavity to unhook it from front housing A.

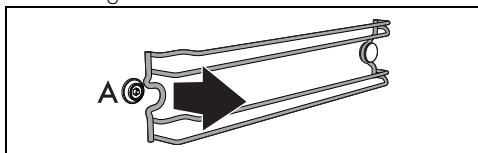

3. Remove the frame from the rear pin B located at the bottom of the side wall.

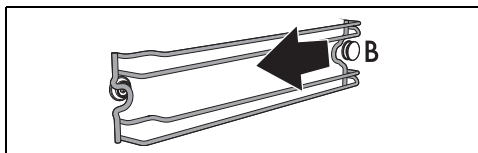

4. Repeat the operation for the frame placed on the other side wall.

To refit the rack/tray support frames:

1. Slide the rear part of the frame into the housing under the pin B located at the bottom of the side wall.

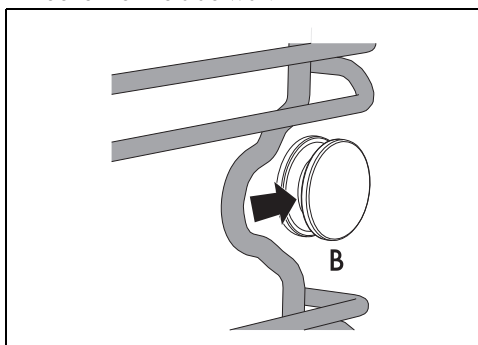

2. Replace the front part of the frame in housing A on the side wall near the opening of the oven cavity.

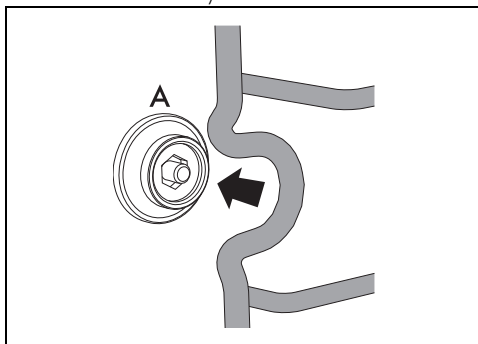

3. Screw in the front fixing pin (you can help yourself with a tool, e.g. a coin).

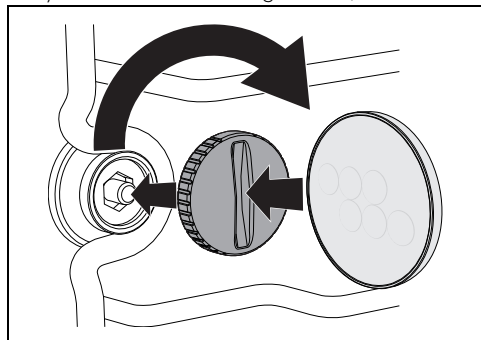



4. Repeat the operation for the frame placed on the other side wall.

### Special cleaning functions

- From position 0, turn the function knob to the left by one position. The  button flashes.

### Vapor Clean (on some models only)

 See General safety instructions.

 The Vapor Clean function is an assisted cleaning procedure that facilitates the removal of dirt. Thanks to this process, it is possible to clean the inside of the oven very easily. The dirt residues are softened by the heat and water vapour for easier removal afterwards.

### Preliminary operations

Before starting the **Vapor Clean** cycle:

- Completely remove all accessories from inside the oven.
- Remove the temperature probe, if present.
- Remove the self-cleaning panels, if present.
- Pour approx. 120 cc of water onto the floor of the oven. Make sure it does not overflow out of the cavity.
- Spray a water and washing up liquid solution inside the oven using a spray nozzle. Direct the spray towards the side walls, upwards, downwards and towards the deflector.



 We recommend spraying approx. 20 times at the most.



 Do not spray the deflector if it has a self-cleaning coating.

- Close the door.
- During the assisted cleaning cycle, wash the self-cleaning panels (where fitted), which were previously removed, separately in warm water and a small amount of detergent.



EN

### Vapor Clean cycle setting

 If the indoor temperature is higher than expected, the function is not activated and every time the  button is pressed the appliance makes a beep. Let the appliance cool down before activating the function.

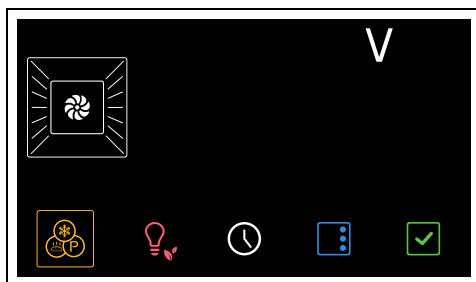
1. After entering the special functions menu, press the  and  touch buttons on the control panel until the  function is selected.



2. Press the  button to confirm.
3. Fill the reservoir with clean water until the maximum level indicator light  displays.
4. At the end, remove the funnel and place the loading drawer back in its place.

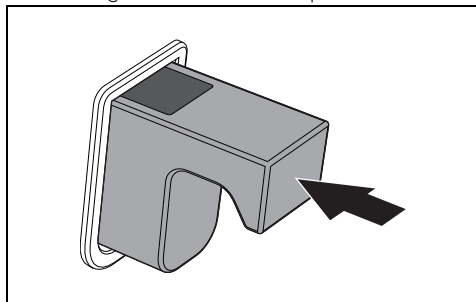

- Press the  button to start the function.

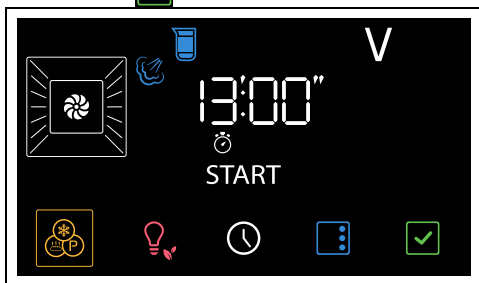

 The duration and temperature parameters cannot be changed by the user.

At the end, **End** is displayed and flashes and a beep is activated.



- Press the  touch button on the control panel to exit the function.

### Programmed Vapor Clean cycle

It is possible to program the Vapor Clean function start time, like any cooking function.

- After selecting the Vapor Clean function, press the  button.

The  and  indicator lights on the display flashes.

- press the  and  touch buttons on the control panel to set the function end time.
- Press the  button to confirm.



The appliance waits until the set start time to start the Vapour Clean function.

### Reservoir draining

 Before draining the reservoir, wait for the oven to cool down, leaving the door open. To make sure that the water remaining in the reservoir is not too hot, wait at least 40 minutes.



After Vapor Clean function:

- Open the door
- Place the deep pan on the second shelf from the bottom. Push it against the rear wall of the oven cavity.

- On the display, press the  button. The  button flashes..

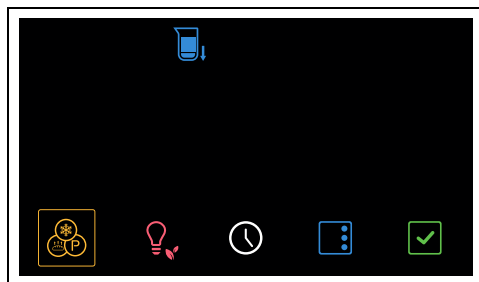
The appliance suggests the Drain reservoir function.



- Press the  button to confirm the function.
- Press the  button again to start the function.

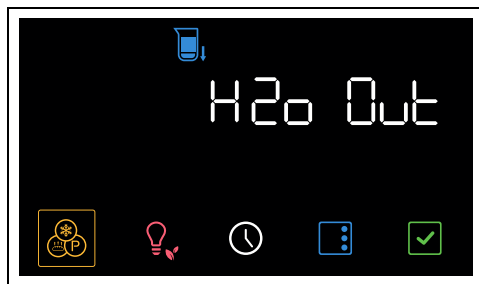

The water starts to flow into the deep pan from the drain pipe on the right side of the rear wall of the oven cavity.

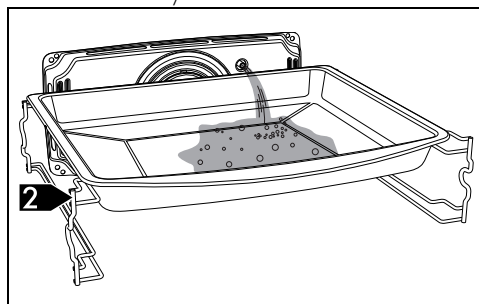

- Wait for the end of the drain flow. At the end the appliance makes a beep and the display shows **End**.
- Press the  touch button on the control panel to exit the function.

## End of Vapor Clean

1. Press the  touch button on the control panel to exit the function.
2. Open the door and wipe away the less stubborn dirt with a microfibre cloth.
3. Use a non-scratch sponge with brass filaments on hard to remove deposits.
4. In case of grease residues use specific oven cleaning products.
5. Remove any remaining water from the oven cavity.
6. Where fitted, reposition the self-cleaning panels and the rack/tray support frames.

For greater hygiene and to avoid foods taking on unpleasant odours:

- we recommend drying the inside of the oven with a fan-assisted function at 160°C for around 10 minutes.
- Where the self-cleaning panels are fitted, we recommend drying the oven cavity with a simultaneous catalytic cycle.

 We recommend wearing rubber gloves for these operations.

 For easier manual cleaning of parts that are difficult to reach, we recommend removing the door.

## Descaling



 The presence of scale due to lack of descaling can compromise correct operation of the appliance in the long term.

 Descaling is a long process (more than one hour) that requires the user to be present in front of the appliance.

Periodically the display will prompt you to perform the boiler descaling procedure.



 We recommend performing descaling every time this is indicated on the display in order to keep the boiler in perfect operating condition.

 The descaling process can be cancelled 2 consecutive times by pressing the  button on the display. After this, the appliance will not allow you to run any other function until the descaling process is performed.

## Preliminary operations

1. Open the door.
2. Place the deep pan on the second shelf from the bottom. Push it against the rear wall of the oven cavity.
3. Press the  button to confirm.

The appliance suggests the Drain reservoir function.

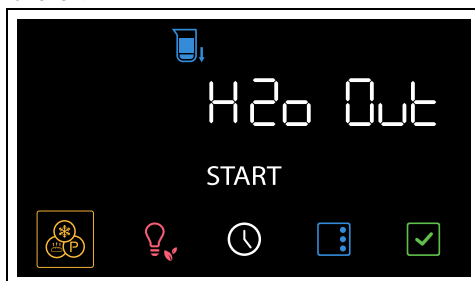

4. Press the  button to confirm.

The water starts to flow into the deep pan from the drain pipe on the right side of the rear wall of the oven cavity.

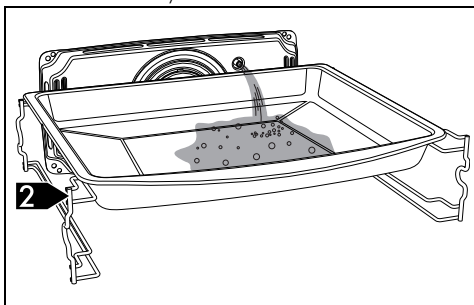

5. Wait for the end of the drain flow. A beep sounds when finished.
6. Drain the water from the deep pan. Press the  button to continue the function. The

indicator light  flashes.



 From now on, it will no longer be possible to cancel the descaling process.

### Reservoir filling

1. Mix 150 g of citric acid with 1 l of water in a jug.

 Do not use lactic acid or other descaling agents.

2. Open the door and pull the loading drawer out of its housing.

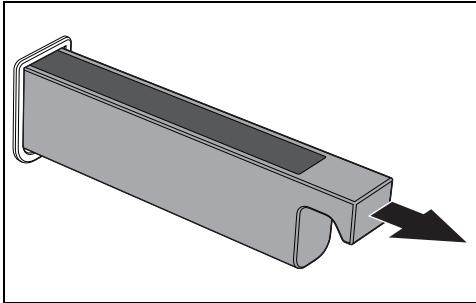

3. Insert the funnel provided in the loading drawer.

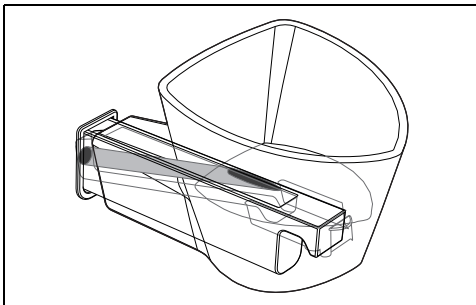

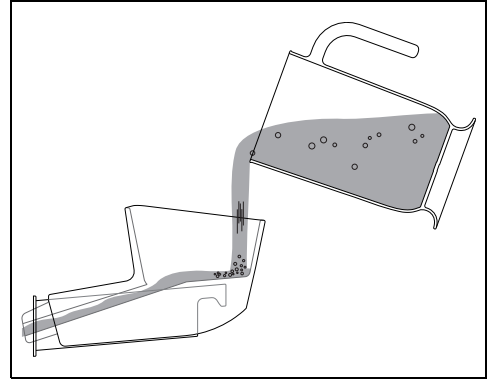

4. Pour in the descaling solution until the max.

level indicator light  comes on.

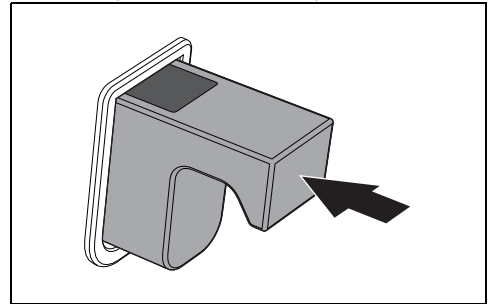

5. At the end, remove the funnel and place the loading drawer back in its place.



 If there is too much water in the reservoir, the excess water will drain into the oven cavity. In this case dry with a cloth or sponge before proceeding.

### Boiler descaling function

1. Close the door
2. Press the  button to start the function.
3. Descaling starts. The heating elements are activated for the first 10 minutes of the process.





Each time the door is opened, the function in progress stops and then automatically restarts when the door is closed again.

- After 10 minutes, the heating elements switch off while the descaling procedure continues for 50 minutes.

At the end of the descaling process, the appliance makes a beep. The indicator light



comes on to indicate the request to drain the water softener.

### Reservoir draining

- Open the door
- Place the deep pan on the second shelf from the bottom. Push it against the rear wall of the oven cavity.

- Press the  button to start the function.

The descaling solution starts to flow into the deep pan from the drain pipe on the right side of the rear wall of the oven cavity.

- Wait for the end of the drain flow.

A beep sounds when finished.

- Drain the descaling solution from the deep pan.



Take care: the descaling solution may be still hot.

### Rinse

Once the descaling agent has been drained, the hydraulic circuit must be rinsed with clean water.



Use cold tap water which is not too hard, softened water or still mineral water.



Do not use distilled water, tap water with a high chloride content (> 40 mg/l), or other liquids.

The display will show the request to fill the

reservoir with water.

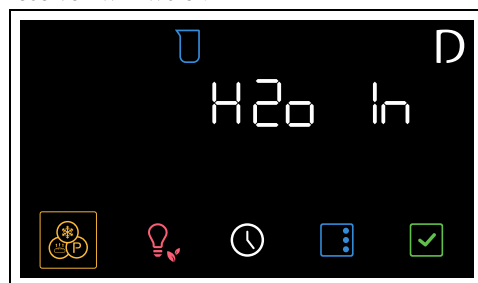

- Open the door.
- Place the deep pan on the second shelf from the bottom. Push the tray up against the rear wall of the oven cavity.
- Pull the loading drawer out of its housing.
- Insert the funnel provided in the loading drawer.
- Using a bottle or measuring jug, pour in enough water to allow some to overflow into the oven cavity (about 1.2 litres is recommended).



The overflowing of water inside the oven cavity is not intended as a malfunction, rather it is part of the rinsing procedure.

- Press the  button to start the function and wait one minute.

At the end, the appliance makes a beep and the display shows the request to drain the

reservoir (the indicator light  comes on).

- Press the  button again to start the function.

- Wait for the end of the drain flow.

A beep sounds when finished.

- Drain the water from the deep pan.

The display shows the new request to fill the reservoir with water.

- Place the deep pan on the second shelf from the bottom. Push it against the rear wall of the oven cavity.

- Pour one litre of water into the funnel placed in the loading drawer (using a bottle or a graduated jug) until it has overflowed to the bottom of the cavity.

- Press the  button to start the function and wait one minute.

At the end, the appliance makes a beep and

the display shows the request to drain the reservoir (the indicator light  comes on).

13. Press again the  button to drain the water from the reservoir into the deep pan.
14. Wait for the end of the drain flow.

A beep sounds when finished. The appliance automatically switches to the sanitization procedure.

### Sanitization



Sanitization with steam allows to remove the last residues of descaling from the hydraulic circuit.

The display will show the request to fill the reservoir with water.

1. Open the door.
2. Place the deep pan on the second shelf from the bottom. Push the tray up against the rear wall of the oven cavity.
3. Pull the loading drawer out of its housing.
4. Insert the funnel provided in the loading drawer.
5. Using a bottle or a measuring jug, pour in water until the tank is full (as shown by the

indicator light  on the display).

6. Press the  button to start the function.

The appliance starts the 30-minute sanitization procedure.

7. Wait for the function to be executed until the end.



Take care: wait for the oven cavity to cool down.

At the end of the function, the appliance suggests the drain reservoir function.

8. Open the door.
9. Place the deep pan on the second shelf from the bottom. Push it against the rear wall of the oven cavity.
10. Press the  button to confirm.

The water starts to flow into the deep pan from the drain pipe on the right side of the rear wall of the oven cavity.





11. Wait for the end of the drain flow.

At the end the appliance makes a beep and the display shows .

12. Drain the water from the deep pan.
13. Wipe off any spillage of water in the cooking compartment with a cloth or sponge.
14. Close the door.

### Manual descaling



When you wish to perform descaling in advance, you can run the function manually:



1. Open the door.
2. Place the deep pan on the third shelf from the bottom. Push it against the rear wall of the oven cavity.
3. After entering the special functions menu, press the  and  touch buttons on the control panel until the  function is selected.
4. Press the  button to confirm.
5. Proceed with the descaling procedure as described in the previous paragraphs.

### Cleaning the reservoir and hydraulic circuit

This function allows the reservoir and the hydraulic circuit of the appliance to be cleaned.

#### Preliminary operations

1. Open the door.
2. Place the deep pan on the second shelf from the bottom. Push it against the rear wall of the oven cavity.
3. After entering the special functions menu, press the  and  touch buttons on the control panel until the  function is selected.

4. Press the  button to confirm. The indicator light  flashes.



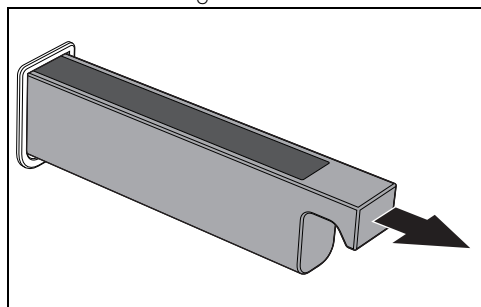

### Reservoir filling

1. Pour 750 ml of clean water into a jug.
2. Open the door and pull the loading drawer out of its housing.

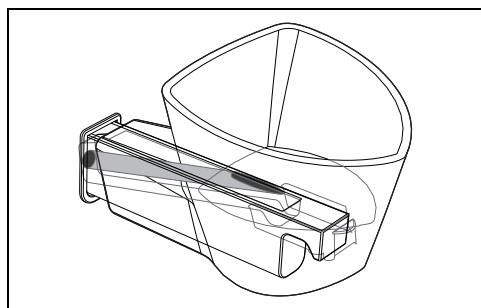

3. Insert the funnel provided in the loading drawer.



4. Pour the water softener until the max. level indicator light  comes on (the reservoir contains about 800 ml of water).

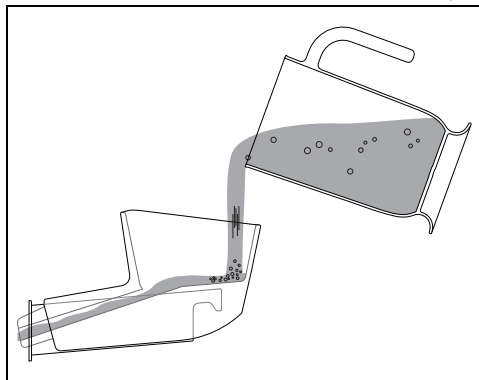

5. At the end, remove the funnel and place the loading drawer back in its place.

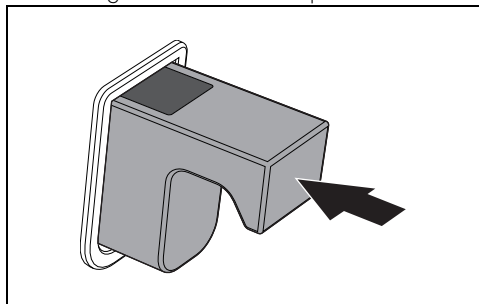

 If there is too much water in the reservoir, the excess water will drain into the oven cavity. In this case dry with a cloth or sponge before proceeding.

6. Press the  button.

The indicator light  comes on to indicate the request to drain the water.

### Reservoir draining

1. Open the door
2. Place the deep pan on the second shelf from the bottom. Push it against the rear wall of the oven cavity.
3. Press the  button again to start the function.

The water starts to flow into the deep pan from the drain pipe on the right side of the rear wall of the oven cavity.

4. Wait for the end of the drain flow.  
At the end the appliance makes a beep and the display shows **End**.

5. Drain the water from the deep pan.



It is recommended to carry out the cleaning process of the reservoir and hydraulic circuit twice.



A cleaning solution can also be used instead of water. In this case it is advisable to carry out at least a couple of water rinses afterwards, following the instructions in this chapter.

## Extraordinary maintenance

### Seal maintenance tips

The seal should be soft and elastic.

- To keep the seal clean, use a non-abrasive sponge and wash with lukewarm water.

### Replacing the internal light bulb



**Power voltage  
Danger of electrocution**

- Unplug the appliance.
- Wear protective gloves.

1. Completely remove all accessories from inside the oven.
2. Remove the rack/tray support frames.
3. Use a tool (e.g. a spoon) to remove the bulb cover.

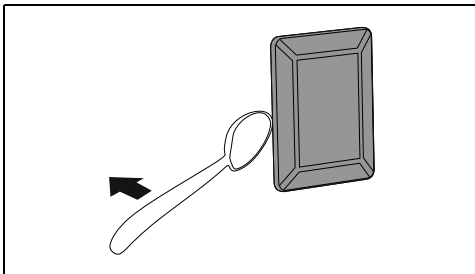

## INSTALLATION

### Electrical connection



See General safety instructions.



Take care not to scratch the enamel of the oven cavity wall.

4. Slide out and remove the light bulb.

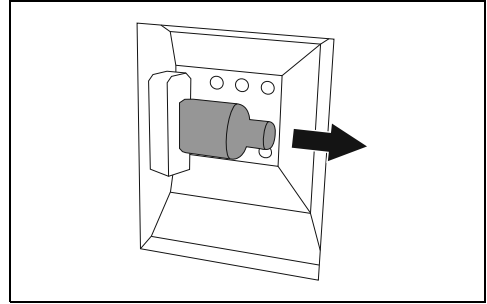

Do not touch the halogen light bulb directly with your fingers, use an insulating material.

5. Replace the light bulb with one of the same type (40 W).
6. Refit the cover. Ensure the moulded part of the glass (A) is facing the door.

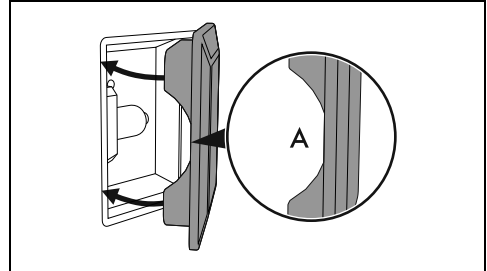

7. Press the cover completely down so that it attaches perfectly to the bulb support.

### General information

Check the mains characteristics against the data indicated on the plate.

The identification plate bearing the technical data, serial number and brand name is visibly

positioned on the appliance.

Do not remove this plate for any reason.

The appliance must be connected to ground using a wire that is at least 20 mm longer than the other wires.

The appliance can work in the following modes:

- **220-240 V~**

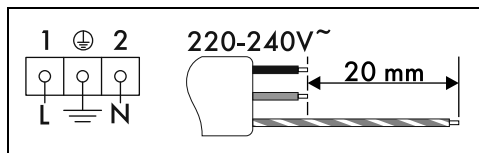

3 x 1.5 mm<sup>2</sup> three-core cable.

The values indicated above refer to the cross section of the internal lead.

The aforementioned power cables are sized taking into account the coincidence factor (in compliance with standard EN 60335-2-6).

### Fixed connection

Fit the power line with an all-pole circuit breaker with a contact separation distance sufficient to provide complete disconnection in category III overvoltage conditions, pursuant to installation regulations.

### For the Australian/New Zealand market:

The circuit breaker incorporated in the fixed connection must comply with AS/NZS 3000.

### Connection with plug and socket

Make sure that the plug and socket are of the same type.

Avoid using adapters, gang sockets or shunts as these could cause overheating and a risk of burns.

### Cable replacement

**Power voltage**  
**Danger of electrocution**

- Disconnect the mains power supply.
1. Unscrew the rear casing screws and remove the casing to access the terminal board.

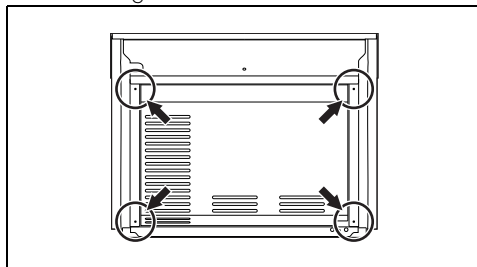

2. Replace the cable.
3. Make sure that the cables (for the oven or any hob) follow the best route in order to avoid any contact with the appliance.

### Positioning

**See General safety instructions.**

### Position of the power cable

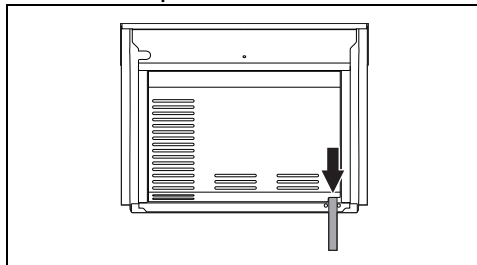

### Front panel seal

Glue the supplied seal to the rear part of the front panel to avoid water or other liquids from leaking in.

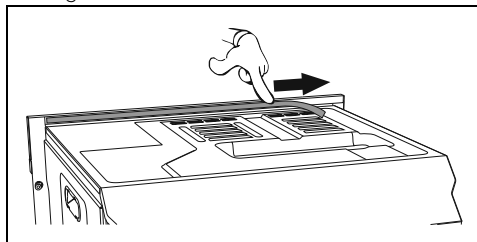

## Fastening bushings

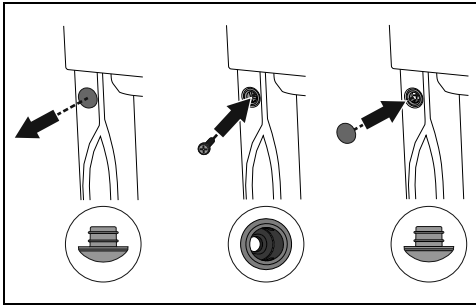

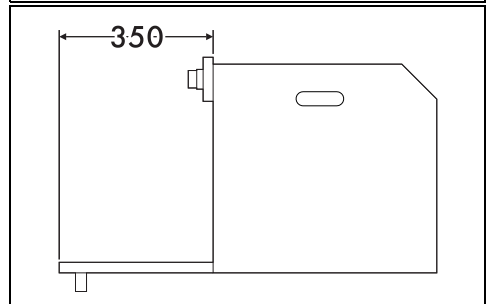
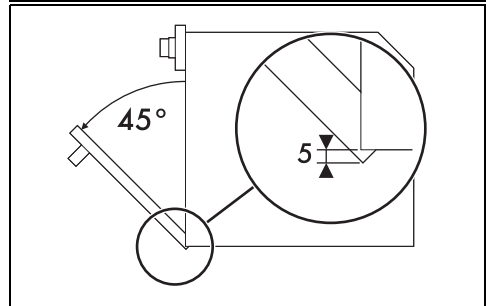
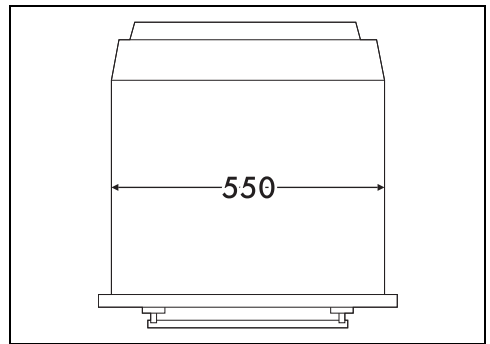
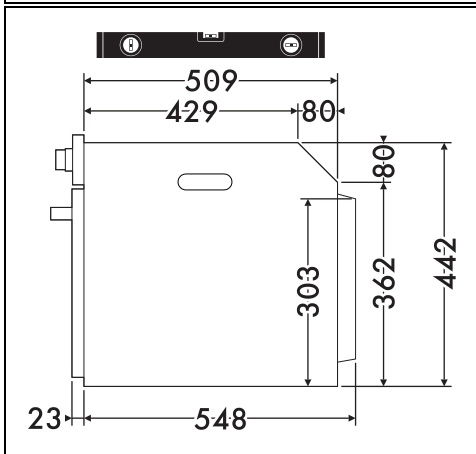
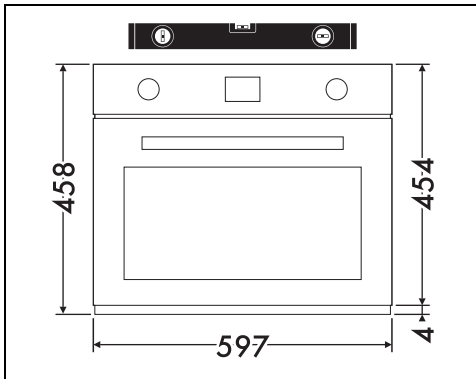

1. Remove the bushing covers on the front of the appliance.
2. Mount the appliance into the recess.
3. Secure the appliance to the cabinet using screws.
4. Cover the bushings with the previously removed covers.

## Appliance overall dimensions (mm)

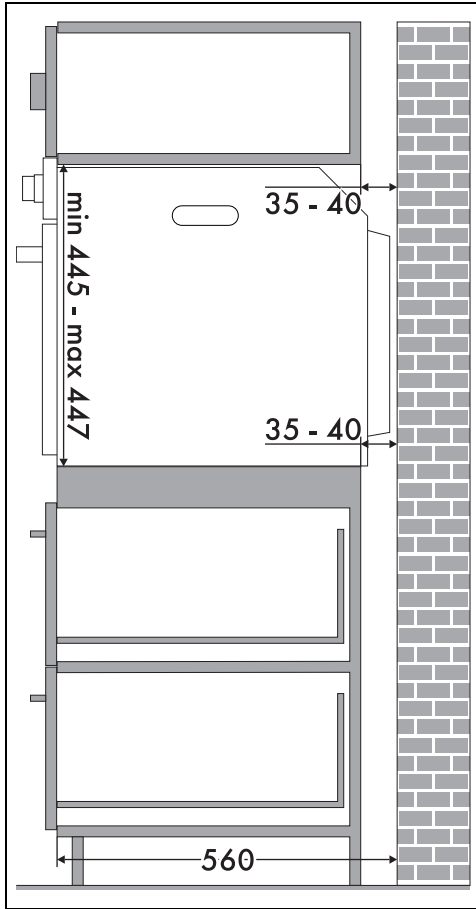

# Mounting into a column (mm)



 \* Make sure that the cabinet top/rear section has an opening approx. 35-40 mm deep.

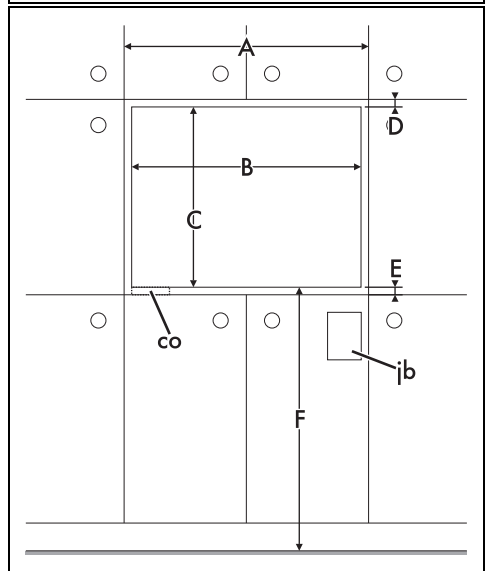
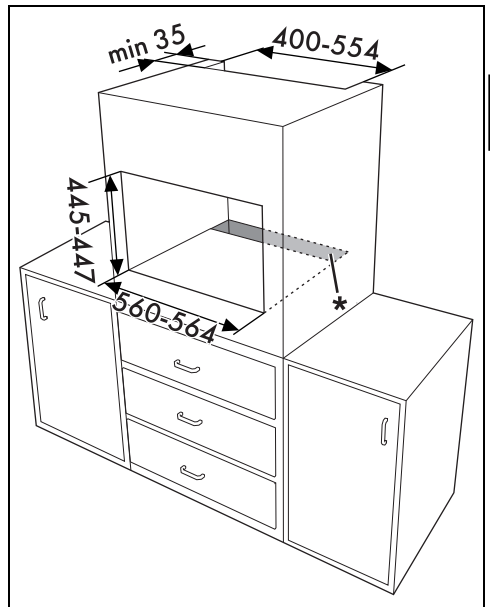

EN

## Mounting under worktops (mm)

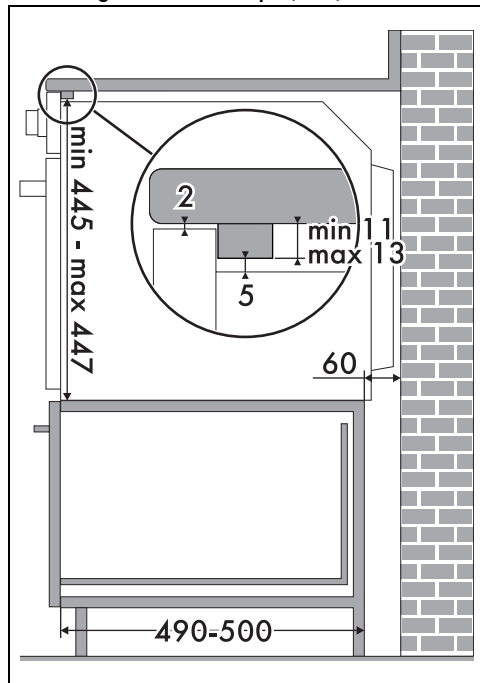
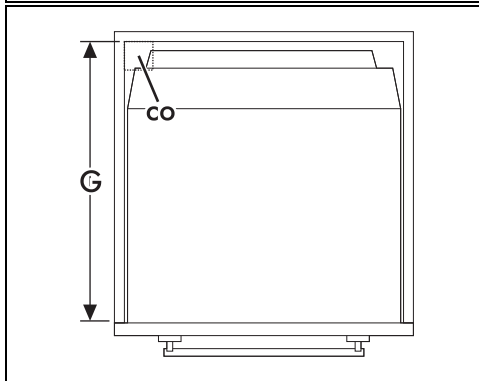
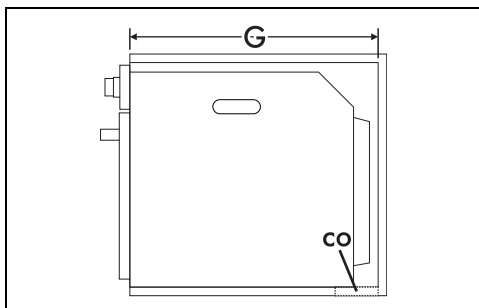

If the appliance is to be built-in under a worktop, a wooden bar has to be installed order to use the seal that is glued to the back of the front panel to prevent water or other liquids leaking in.

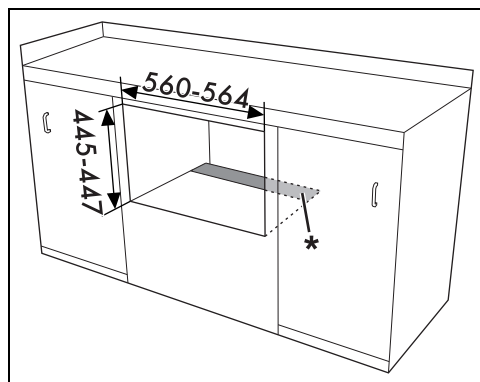

\* Make sure that the piece of furniture top/rear part has an opening approx. 60 mm deep.

A min. 603 mm

B 560 - 564 cm

C 445 - 447 cm

D 9 - 11 cm

E min. 5 mm

F 259 - 1105 cm

G min. 560 mm

H min. 458 mm

co Cutout for power cord (min. 6 cm<sup>2</sup>)

j|b Electrical connection box

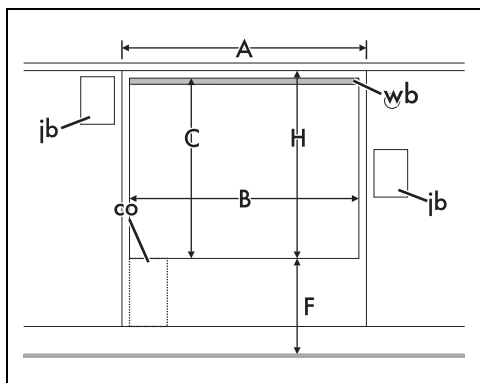

A min. 603 mm

B 560 - 564 cm

C 445 - 447 cm

D 9 - 11 cm

E min. 5 mm

F 259 - 1105 cm

G min. 560 mm

H min. 458 mm

co Cutout for power cord (min. 6 cm<sup>2</sup>)

jb Electrical connection box

wb Wooden bar (recommended)

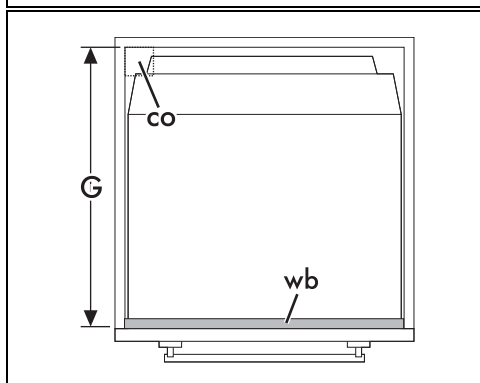
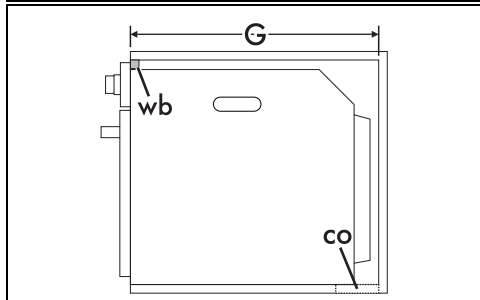

### Mounting under worktops (mm) (pyrolytic models only)

Whenever a hob is installed above the oven, a wooden separator has to be installed at a minimum distance of 20 mm from the top of the oven to prevent overheating when the two appliances are used at the same time. It must only be possible to remove the separator by using suitable tools.

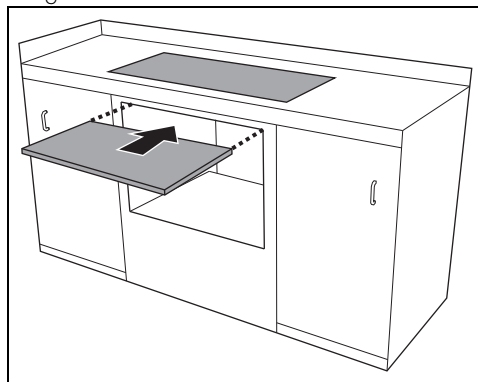

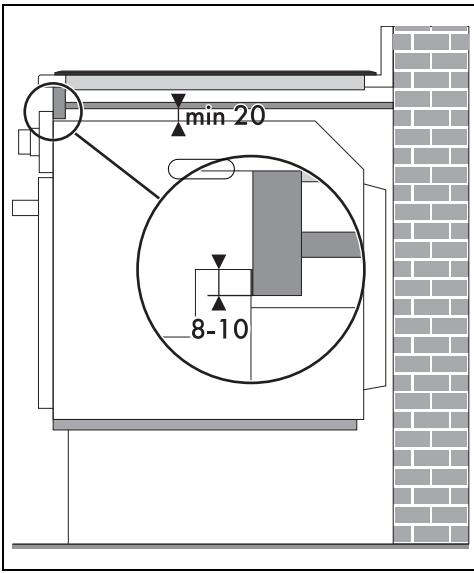

When using a wooden separator, a wooden bar has to be installed under the worktop in order to use the seal that is glued to the back of the front panel to prevent water or other liquids leaking in.