

QUICK SETUP GUIDE

Before using the TV, please read this guide thoroughly and retain it for future reference.

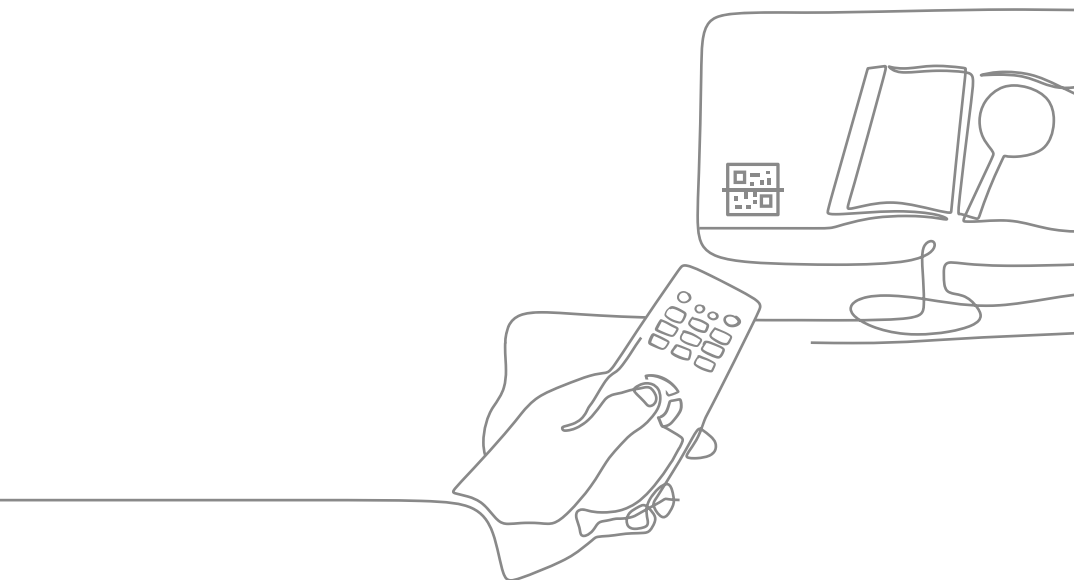



Figures and illustrations in this manual are provided for reference only and may differ from actual product appearance.

Parts of the software function changes with the system upgrade.

If you encountered difficulty when setting up your TV, we suggest you refer to the troubleshooting tips in the User Manual or the E-Manual.

Find what you want

This TV is equipped with this quick setup guide and embedded E-Manual (**Settings > Support > E-Manual**).

E-Manual support functions		
	Search	Find the help you are looking for.
	Try Now	Go directly to the function page and try it.
	QR Code	Scan to open the E-Manual on your mobile device.

Contents

Installation	1
TV Front and Rear	5
Connection	6
Remote Control	8
Specifications	10
Other Information.....	11

Accessories List

The following accessories are included with TV:

Quick Setup Guide × 1	Power Cord × 1	Remote Control × 1
AAA Battery × 2 (For Solar Powered Remote, the battery is built in)		Cable Clamps × 6
Base Stand × 2	Screw × 6 (for installing base stands)	
Handle × 2	Screw × 4 (for installing handles)	P-Clip × 2

The accessories may be different from the list above due to different models, countries/regions, please refer to the actual accessory bag.

Declaration





Any content and service accessed through this device, while only intended for individual non-commercial use, shall be the property of the applicable third party and subject to protection by regulations and laws on copyright, patent, trademark and other intellectual property rights. No part of such content and service may be modified, duplicated, published, uploaded, distributed, translated, marketed, or used to make and distribute products derived from it without the prior permission of the content owner or service provider.

You acknowledge and agree explicitly that you will solely bear the risk associated with the use of this device, and further you will solely bear any risk related to satisfactory quality, performance and accuracy for any content and service accessed through this device. To the maximum extent permitted by applicable law, this device and any third party's content and service is provided as it is without any guarantee, express or implied.

Manufacturer hereby declare explicitly that Manufacturer shall not be held liable for any guarantee and conditions, express or implied, related to this device and any content and service, including but not limited to warranty on marketability, satisfactory quality, fitness for a particular purpose, accuracy, quiet use and non-violation of any third party's rights; to the maximum extent permitted by applicable law, Manufacturer gives no guarantee on the accuracy, validity, timeliness, legitimacy and completeness of any content or service provided through this device, or the fitness of such device, content or service for your particular requirement, or the protection from interruption and error during operation of such device, content or service; to the maximum extent permitted by applicable law, in any case, including fault or neglect, Manufacturer shall not be held liable for legal actions or indemnity obligation arising from any consequence as a result of or related to any information loaded in this device or use of such device, content or service by you or any third party.

Any content and service provided as it is together with this device shall be the property of the applicable third party, therefore Manufacturer gives no declaration or warranty on modification, suspension, cancellation, termination or abortion thereof, and shall not be held liable for legal actions or indemnity obligation arising thereof.

Manufacturer reserves the rights to restrict the use or access of certain content or service. As the content and service are transmitted through third party's network and transmission facilities, Manufacturer undertakes no customer service thereof or the obligation for such customer service.

 <p>This symbol alerts user about the presence of a dangerous voltage not isolated inside the product which can be sufficiently powerful to constitute a risk of electrocution.</p>  <p>This symbol alerts user about the presence of important operating instructions and maintenance in the document enclosed in the package.</p>	 <table border="1" data-bbox="665 1262 895 1343"><tr><td>ATTENTION</td></tr><tr><td>RISK OF ELECTRIC SHOCK</td></tr></table>  <p>Do not open the back cover.</p> <p>In no case the user is allowed to operate inside the TV set. Only a qualified technician is entitled to operate.</p>	ATTENTION	RISK OF ELECTRIC SHOCK
ATTENTION			
RISK OF ELECTRIC SHOCK			



Warning

Stability Hazard

A television set may fall, causing serious personal injury or death. Many injuries, particularly to children, can be avoided by taking simple precautions such as:

- ALWAYS use cabinets or stands or mounting methods recommended by the manufacturer of the television set.
- ALWAYS use furniture that can safely support the television set.
- ALWAYS ensure the television set is not overhanging the edge of the supporting furniture.
- ALWAYS educate children about the dangers of climbing on furniture to reach the television set or its controls.
- ALWAYS route cords and cables connected to your television so they cannot be tripped over, pulled or grabbed.
- NEVER place a television set in an unstable location.
- NEVER place the television set on tall furniture (for example, cupboards or bookcases) without anchoring both the furniture and television set to a suitable support.
- NEVER place the television set on cloth or other materials that may be located between the television set and supporting furniture.
- NEVER place items that might tempt children to climb, such as toys and remote controls, on the top of the television or furniture on which the television is placed.

If your existing television set is being retained or relocated, the same considerations as above should be applied.

Safeguards

Please read the following safeguards for your TV and retain for future reference.

Always follow all warnings and instructions marked on the television.

1. A note about safety and operating instructions

Read and follow all safety and operating instructions, and retain them safely for future reference.

2. Heed Warnings

Adhere to all warnings on the appliance and in the operating instructions.

3. Cleaning

Unplug the TV from the wall outlet before cleaning. Do not use liquid, abrasive, or aerosol cleaners. Cleaners can permanently damage the cabinet and screen. Use a lightly dampened cloth for cleaning.

4. Wall Mount Bracket

Wall mount bracket is only available for some models. If wall mount bracket is not supplied with this product, you can buy it at the local market.

Please refer to the Installing the Wall Mount Bracket page for dimensions.

5. Water and Moisture

Avoid dripping or splashing of liquids onto the product. Objects filled with liquids, such as vases, should not be placed above the product.

6. Setting

Do not place this TV on an unstable cart, stand or table. Placing the TV on an unstable base can cause the TV to fall, resulting in serious personal injuries as well as damage to the TV. Use only a cart, stand, bracket or table recommended by

the manufacturer or salesperson.

7. Ventilation

Slots and openings in the cabinet are provided for ventilation, to ensure reliable operation of the TV and to protect it from overheating. Do not cover the ventilation openings in the cabinet and never place the set in a confined space such as built-in cabinet unless proper ventilation is provided. Leave a minimum 10cm gap all around the unit, the rear of the TV should be 6cm away from the wall.

8. Power Source

This TV should be operated only from the type of power source indicated on the marking label. If you are not sure of the type of power supplied to your home, consult your appliance dealer or local power company.

9. Power-Cord Protection

Power-supply cords should be routed so that they are not likely to be walked on or pinched by items placed upon or against them, paying particular attention to cords at plug, wall outlets, and the point where they exit from the TV. MAIN plug on the power cord is used as the disconnect device, the disconnect device and socket-outlet shall be easily accessible.

10. Lightning

For added protection for this TV during a lightning storm, or when it is left unattended and unused for long periods of time, unplug it from the wall outlet and disconnect the antenna or cable system. This will prevent damage to the TV due to lightning or power-line surge.

11. Power Lines

An outside antenna system should not be located in the vicinity of overhead power lines or other electric light or power

circuits, or where it can fall into such power lines or circuits. Where installing an outside antenna system, extreme care should be taken to keep from touching such power lines or circuits as contact with them might be fatal.

12. Overloading

Do not overload wall outlets and extension cords as this can result in a risk of fire or electric shock.

13. Object and Liquid Entry

Never push objects of any kind into this TV through openings as they may touch dangerous voltage points or short-out parts that could result in fire or electric shock. Never spill liquid of any kind on or into the TV.

14. Outdoor Antenna Grounding

If an outside antenna or cable system is connected to the TV, be sure the antenna or cable system is grounded so as to provide some protection against voltage surges and built-up static charges.

15. Servicing

Do not attempt to service this TV yourself as opening or removing covers may expose you to dangerous voltage or other hazards. Refer all servicing to qualified service personnel.

16. Damage Requiring Service

Unplug the TV from the wall outlet and refer servicing to qualified service personnel under the following conditions:

- (a) When the power - supply cord or plug is damaged.
- (b) If liquid has been spilled, or objects have fallen into the TV.
- (c) If the TV has been exposed to rain or water.
- (d) If the TV does not operate normally by following the operating instructions.

Adjust only those controls that are covered by the operating instructions as an improper adjustment of other controls may result in damage and will often require extensive work by a qualified technician to restore the TV to its normal operation.

- (e) If the TV has been dropped or the cabinet has been damaged.
- (f) When the TV exhibits a distinct change in performance - this indicates a need for service.

17. Replacement Parts

When replacement parts are required, be sure the service technician has used replacement parts specified by the manufacturer or have the same characteristics as the original part. Unauthorized substitutions may result in fire, electric shock or other hazards.

18. Safety Check

Upon completion of any service or repair to the TV, ask the service technician to perform safety checks to determine that the TV is in safe operating condition.

19. Heat

The product should be situated away from heat sources such as radiators, heat registers, stoves, or other products (including amplifiers) that produce heat.

20. Fire

The product should be situated away from naked flame sources such as lighted candle.

21. Off-gassing

The TV smells of plastic is normal and will dissipate over time.



Do not mix and use new batteries with old batteries, or batteries with different types. Do not expose batteries to heat such as direct sunlight or fire. Make sure the batteries' positive and negative ends are facing the correct direction.



The device should not be exposed to dripping and spraying and it cannot be placed under objects filled with liquids.



To fully disconnect the TV, remove power plug from wall socket. Be sure to have the wall socket and power plug readily accessible.



AC voltage: This symbol indicates that the rated voltage marked with the symbol is AC voltage.



Class II product: This symbol indicates that it does not require a safety connection of protective earthing (ground).

Installation

⚠ CAUTION

- Be sure to disconnect the AC power cord before removing a base stand or installing wall mount brackets.
- The display on your TV is fragile. Make sure the TV screen is not scratched or damaged by hard objects or from pressure.
- After the installation is complete, make sure the TV is steady on a table or firmly attached to a wall mount, before removing all protective film, if any.

▶ Installing the stand

Follow the illustrations and textual instructions below to complete the installation steps:

⚠ CAUTION

- Four or more people are needed to lift and move the TV. The weight of TV with base stands is 239.2 lbs (108.5 kg). The furniture where the TV is placed should be tough enough to support. Make sure that the width of the furniture is above 19.2 inches (487 mm).
- One person holds the TV to prevent it from tipping during the whole installation process.

1. One person holds the side of the TV, and the others remove the side cushions. Do not pinch the screen while holding the TV.

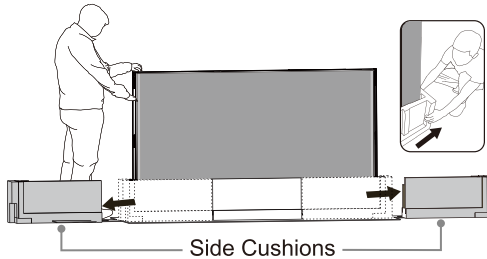

2. Attach the TV base stands to the slots on TV back cover. Use the screws provided to secure each base stand tightly.

Note: If your table is long enough to place the TV, then insert the base stands into the screw holes 'A' that are shown in the illustration. If your table is NOT long enough, then insert the base stands into the screw holes 'B' that are shown in the illustration. Note that these two installation types cannot be mixed.

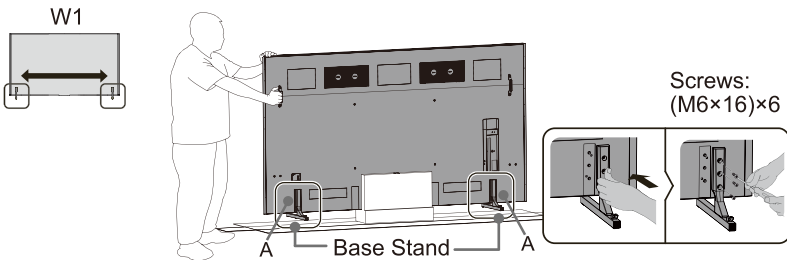

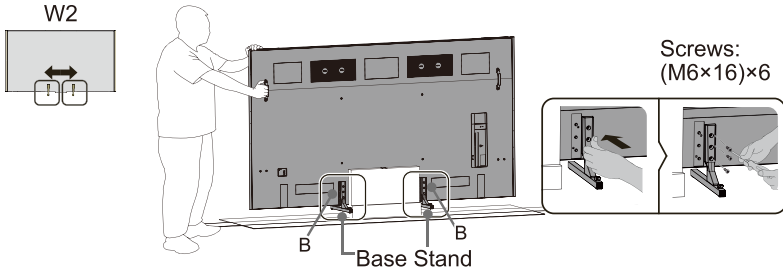

3. Before attaching the handles, please remove pre-installed screws on the TV back cover.

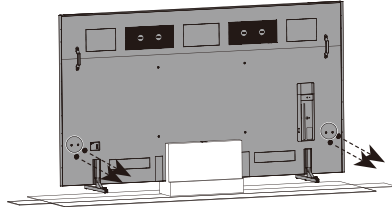

4. To install the handles, fasten the provided 4 screws by rotating clockwise. Then carefully move the TV to the desired location as shown in the **Figure 3**. Once the TV is positioned, remove the handles by rotating the screws counterclockwise.

NOTE: Before positioning the TV, you can manage cables within cable clamps according to your own need.

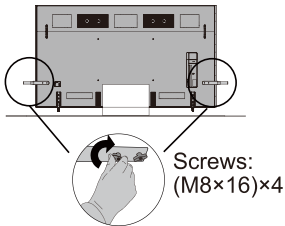

Figure 1 Rotate clockwise to fasten

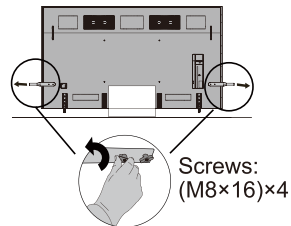

Figure 2 Rotate counterclockwise to remove

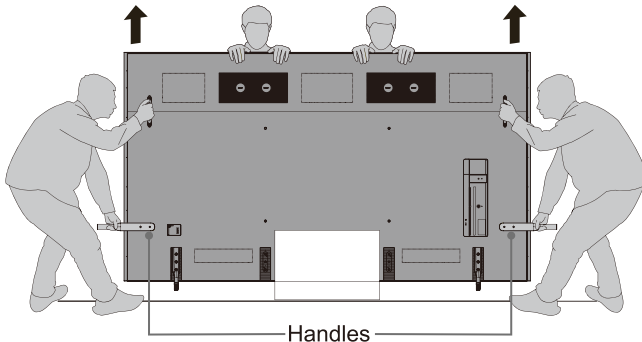

Figure 3 Lift the TV up and move it

▶ Attaching cable clamps and managing cable

⚠ CAUTION

Before moving the TV to a desired location or installing the wall mount on the wall, make sure that you have connected and managed power cord and all cables you need.

Take out cable clamps from the accessory bag. Paste them in the positions shown in the figure and manage cables within the cable clamps.

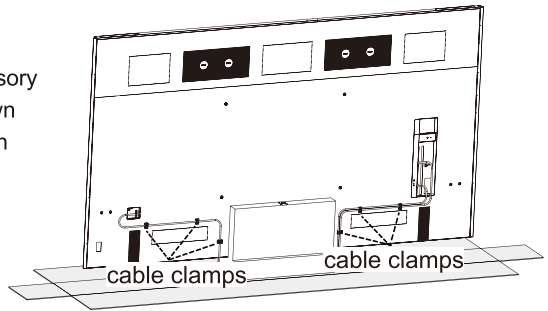

▶ Installing the wall mount bracket

Before mounting the TV, remove the TV stand if you have already attached it, and make sure the wall mount bracket supports the weight of your TV.

⚠ CAUTION

- When mounting the TV on a wall, follow instructions provided with the wall mount bracket. If it is not correctly mounted, the TV may fall and cause property damage or personal injury.
- Four or more people are needed to lift and move the TV. The weight of TV without base stands is 224.9 lbs (102.0 kg), make sure the wall and the wall mount bracket are tough enough before hanging the TV.
- Place spacers between the TV and bracket.
- Standard dimensions are shown below.

Wall mount hole pattern (mm)	800 × 600
Wall mount screw size	M8
Number of wall mount screw	4

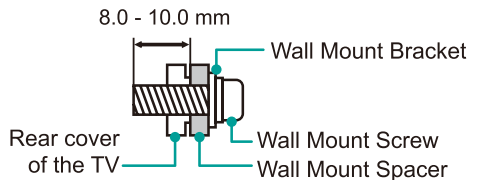

- We do not recommend hanging the TV on a slanted wall, and when wall mounting make sure your television remains parallel to the wall and does not lean forward.

📌 NOTE

- The diameter and length of the screws differ depending on the wall mount bracket model.
- Wall mount bracket is optional. Your TV may not have wall mount bracket. Please refer to the actual accessories.

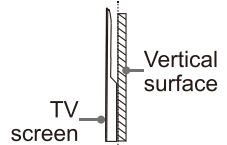

► Installing the P-Clip

Please place the TV on a horizontally stable surface, and then use P-Clip to connect the TV and the wall or pillar. (Marked in the illustration below.)

☒ NOTE

Please attach one end of the P-Clip to a concrete wall or brick structures wall. Wood or gypsum structures wall cannot be used directly and is in need of special reinforcement.

1. Drill two fixation holes on the wall. The aperture is 12mm and depth is 70mm.
2. Insert two expansion bolts into the hole.
3. Select two suitable screw holes on the TV back based on the actual situation. Remove the screw pre-installed in the hole.
4. Screw Part A of P-Clip into the screw hole on the TV back.

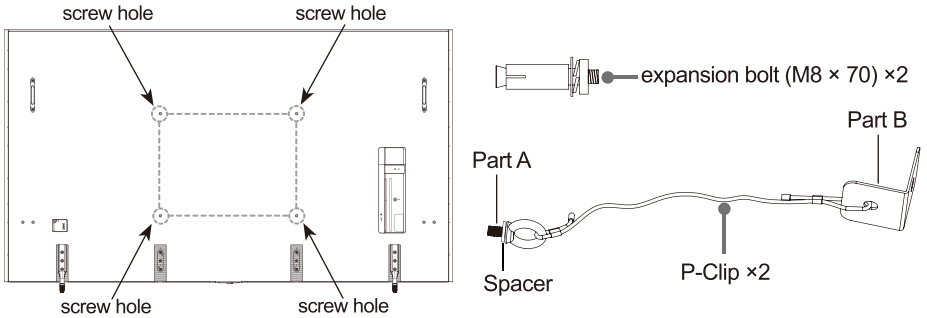

5. Fix and tighten Part B of P-Clip to the expansion bolt as the illustration shows.

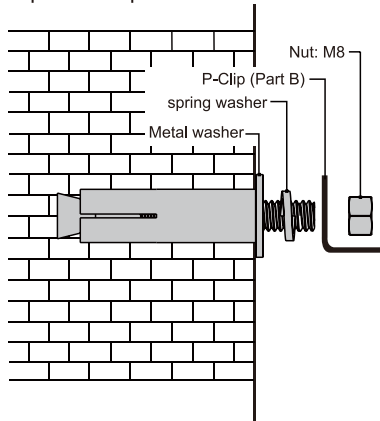

☒ NOTE

- Insecure installation may cause the tilt or falling of the product, and further lead to personal injuries or product damages. If the method above can not fix the product, please consult the manufacturers.
- P-clip and corresponding screws may not included with TV set, please purchase them by yourself if necessary.

TV Front and Rear

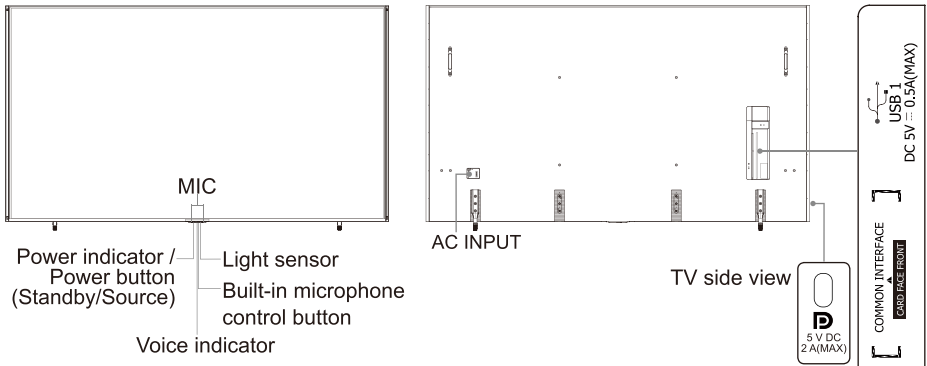

Item	Description
Power indicator	The light is white in standby mode.
Power button (Standby/Source)	Press the button to turn the TV on. Press it again to bring up the control menu and move the focus between different inputs. Long press the button to make a selection.
Light sensor	The light-sensing function automatically adjusts the TV's backlight brightness to match the ambient light levels in the room, providing an optimised viewing experience. To enable or disable light sensor, please go to Settings > Picture > Picture Mode Settings > Advanced Settings > Brightness > Light Sensor settings , and toggle on or off Automatic Light Sensor as needed.
Built-in microphone control button	Switch the built-in microphone control button to on to use the built-in microphone. After the Alexa or VIDAA Voice setup has been completed and Hands-Free mode is turned on, you can use Hands-Free Wake-up, just say "Alexa" or "Hey VIDAA" to call up the voice assistant.

NOTE

- ANT2 Jack supports power supply for satellite antenna (13/18V, 420mA max).
- DVB-S/S2 may not be applicable in some models/countries/regions.
- Check the jacks for position and type before making any connections. Loose connections can result in image or colour problems. Make sure that all connections are tight and secure.
- Not all A/V devices have the ability to connect to a TV, please refer to the user's manual of your A/V device for compatibility and connections procedure.
- Before connecting external equipment, remove the mains plug from the wall socket. Otherwise, it may cause electric shock.
- Powering on the TV requires several seconds to load programmes. Do not rapidly turn the TV off as it may cause the TV work abnormally.
- The Picture is Only for Reference.
- Before using Hands-Free Wake-up, connect your TV to the network. The Hands-Free Wake-up and some of its features are available on limited country/region/language.



Connection

► Terminals

ANT	Connect an outdoor VHF/UHF antenna or cable. Connecting a satellite antenna.
HDMI	Connect an HDMI cable from an external equipment.
HDMI (eARC)	Connect an HDMI cable from an external digital audio system. Please note that it works only when the TV is connected to the audio receiver that supports the eARC function.
AV IN	Connect a composite video cable and left-right audio cables from an external AV device.
USB	Connect a USB device for browsing photos, listening to music and watching movies. NOTE <ul style="list-style-type: none">When connecting a hard disk or a USB hub, always connect the mains adapter of the connected device to the power supply. If a USB 1.1 or USB2.0 device requires more than 500mA or 5V, the USB device may not be supported. Max supported current for USB 3.0 device is 1A (only for some models). Exceeding the max supported current may result in damage or data loss.Certain digital cameras may not be compatible with the TV.
DIGITAL AUDIO OUT	Connect an optical cable from an external digital audio system.
LAN	Connect an Ethernet cable to access a network or the Internet.
HEADPHONE	Connect headphone for audio out of the TV. ATTENTION <ul style="list-style-type: none">Excessive sound pressure from earphones and headphones can cause hearing loss.
COMMON INTERFACE	Insert the CI+ module for watching scrambled services like pay-tv channels or some HD channels. NOTE <ul style="list-style-type: none">Do not repeatedly insert or remove the Common Access Module as this may damage the interface and cause a malfunction.You must obtain a CI+ module and card from the service provider of the channels you want to watch.CI+ is not supported in some countries and regions.
DisplayPort over USB Type-C	DP (DisplayPort™) is a display input interface. Connect a Full-Featured Type-C standard cable to PC or smart device to use your TV as a monitor. NOTE <ul style="list-style-type: none">In case you connect DP port with a Type-C cable or converter adaptor that is not fully compatible with DP standard, DP function may not work.

NOTE

- The location and names of the terminals on the TV may vary according to TV model, and not all terminals available on all models.

► Network

Wired setup

Connect your TV to your network by connecting the LAN port on the back of your TV to an external modem or router using a LAN (Ethernet/Cat 5) cable. See the illustration below.

- We recommend you to use a modem or router that supports Dynamic Host Configuration Protocol (DHCP). Modems and routers that support DHCP automatically provide the IP address, subnet mask, gateway, and DNS, so you don't have to enter them manually. Most home networks already have DHCP.

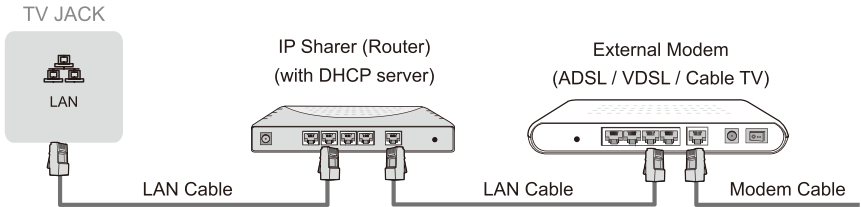

Wireless setup

Connect your TV to your wireless network, you need a wireless router or modem. See the illustration below.

- The TV's built-in Wireless LAN Adapter supports the IEEE 802.11 a/b/g/n/ac/ax communication protocols.

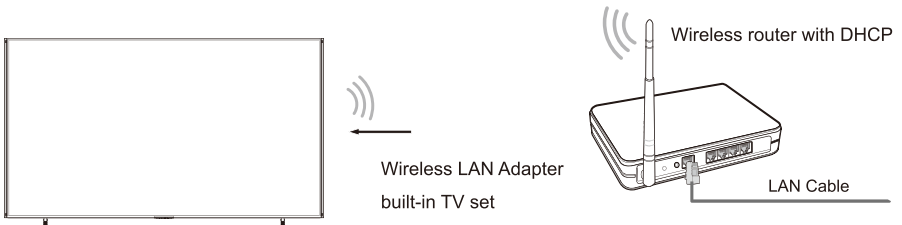

NOTE

- You must use the built-in Wireless LAN Adapter to use a wireless network because the set doesn't support external USB network adapter.
- If the wireless router supports DHCP, your TV can connect more easily to the wireless network.
- If you apply a security system which is not listed below, it will not work with the TV.
Security system : WPA, WEP, WPA2, WPA3.
- In order to guarantee smooth network, the distance between router and TV should be less than 10 meters.

Remote Control

► Buttons of remote control

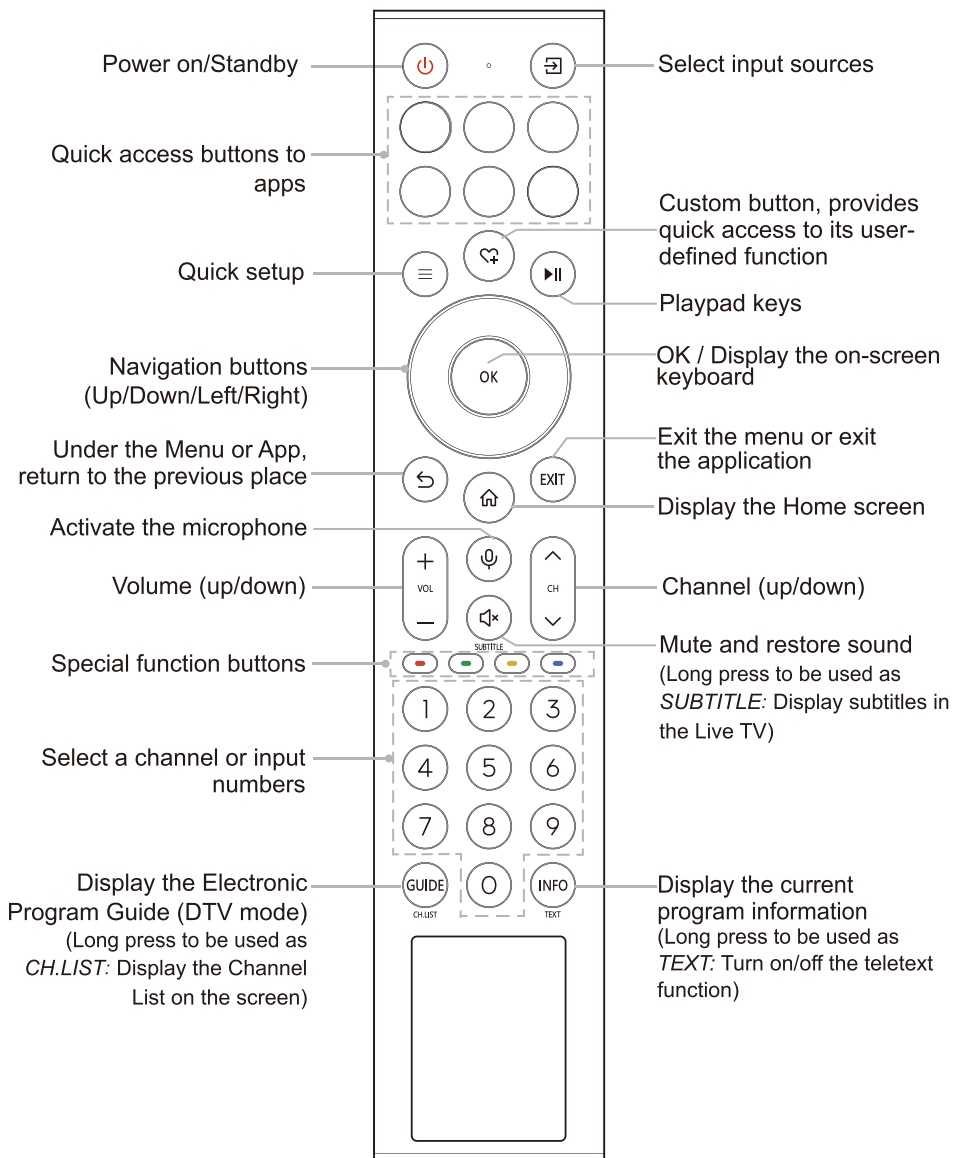

NOTE

The included remote control will vary depending on model, country/region. Check information according to the actual remote control in the accessory bag.

► Charging the Remote Control

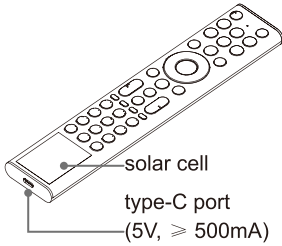

You can charge the remote by exposing the solar cell to light or using a USB type-C cable(not provided).

When charging by type-C port, the red indicator will blink. When fully charged, the indicator will stop blinking first and then turn off.

NOTE

- Product image is only for reference, actual product may vary in appearance.
- The battery is not user replaceable. Do not try to remove or change the internal battery by yourself, cause it may cause damage to the battery/device, personal injury, fire or explosion.
- When you do not use the remote control, place it face up to make the solar cell expose to light.
- Leaving a battery in an extremely high temperature surrounding environment that can result in an explosion or the leakage of flammable liquid or gas.
- Battery chemicals can cause a rash. If chemicals touch your skin, wash immediately.
- Disposal of a battery into fire or a hot oven, or mechanically crushing or cutting of a battery, that can result in an explosion.
- Place the remote control correctly to prevent it from falling down.
- A battery subjected to extremely low air pressure that may result in an explosion or the leakage of flammable liquid or gas.

► Pairing the Remote Control

Pair the remote to the TV after you power it on. Keep the remote control within 3 metres from the TV. Press any button (except power and mic button) to pair.

NOTE

- In special cases, press and hold [≡] button to pair.
- If an unknown error occurred with the remote, then it could have been caused by interference. Try to remove what's causing the interference and pair it again.
- If an unknown error occurred in the remote control, please recharge and activate the remote control.
- The remote cannot be paired to the TV while the TV is in standby mode.

► Remote Control Operation Range

1. The remote control can work at a distance of up to 8 metres in front of the TV set.
2. The remote control angle: taking the remote sensor as an apex, 6 metres away, its controlled horizontal angle is within $\pm 30^\circ$, while the vertical angle is within $\pm 15^\circ$.
3. The operating distance may vary depending on the brightness of the room.

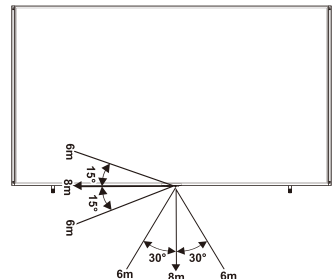

Disposal of this unit

Product should not be damaged, dismantled or thrown in municipal waste. It should be packed and handed over to authorised re-cycler.

Specifications

☑ Features, appearance and specifications are subject to change without notice.

Item		116"
Dimension (mm)	Without Stand (W × H × D)	2631 × 1489 × 40
	With Stand (W × H × D)	2631 × 1543 × 487
Weight (kg)	Without Stand	102.0
	With Stand	108.5
Active Screen Size (Diagonal) (cm)		293
Audio power		15W×2 + 10W×2 + 5W×2 + 15W×2 + 10W×2
Screen resolution		3840 × 2160
Power consumption		Please refer to the rating label.
Power supply		Please refer to the rating label.
Standby Power		0.5W
Receiving systems	Analog	PAL-D/K, B/G, I, SECAM-D/K, B/G
	Digital	DVB-T/T2, DVB-C, DVB-S/S2
Environmental conditions		Temperature: 5°C - 40°C Humidity: 20% - 80% RH Atmospheric pressure: 86 kPa - 106 kPa
HDMI Input		RGB / 60Hz (640×480, 800×600, 1024×768) YUV / 60Hz (480i, 480p, 720p, 1080i, 1080p) YUV / 50Hz (576i, 576p, 720p, 1080i, 1080p) 3840×2160 / 24Hz, 3840×2160 / 25Hz, 3840×2160 / 30Hz, 3840×2160 / 50Hz, 3840×2160 / 60Hz, 3840×2160 / 120Hz, 3840×2160 / 144Hz, 3840×2160 / 165Hz, 2560×1440 / 120Hz, 2560×1440 / 144Hz, 2560×1440 / 165Hz, 2560×1440 / 240Hz, 2560×1440 / 288Hz, 1920×1080 / 120Hz, 1920×1080 / 144Hz, 1920×1080 / 165Hz, 1920×1080 / 240Hz, 1920×1080 / 288Hz



Other Information

► Disposal of Used Electrical & Electronic Equipment



Packaging and electrical goods should be recycled appropriately, and not treated as household waste. Please dispose of this equipment at your applicable collection point for the recycling of electrical & electronic equipment waste. By ensuring the correct disposal of this product, you will help prevent potentially hazardous to the environment and to human health, which could otherwise be caused by unsuitable waste handling of this product. The recycling of materials will help conserve natural resources. Please do not therefore dispose of your old electrical and electronic equipment with your household waste. For more detailed information about recycling of this product, please contact your local city office, your household waste disposal service or the shop where you purchased the product.

► License



The terms HDMI, HDMI High-Definition Multimedia Interface, HDMI Trade dress and the HDMI Logos are trademarks or registered trademarks of HDMI Licensing Administrator, Inc.



Dolby, Dolby Vision, Dolby Atmos, and the double-D symbol are registered trademarks of Dolby Laboratories Licensing Corporation. Dolby Vision IQ is a trademark of Dolby Laboratories Licensing Corporation. Manufactured under license from Dolby Laboratories. Confidential unpublished works. Copyright © 2012-2024 Dolby Laboratories. All rights reserved.



FOR DTS PATENTS, SEE [HTTP://XPERI.COM/DTS-PATENTS/](http://xperi.com/dts-patents/). MANUFACTURED UNDER LICENSE FROM DTS, INC. AND ITS AFFILIATES. DTS, DTS:X, AND THE DTS:X LOGO ARE REGISTERED TRADEMARKS OR TRADEMARKS OF DTS, INC. AND ITS AFFILIATES IN THE UNITED STATES AND/OR OTHER COUNTRIES. © DTS, INC. AND ITS AFFILIATES. ALL RIGHTS RESERVED.



Manufactured under license from IMAX Corporation. IMAX® is a registered trademark of IMAX Corporation in the United States and/or other countries. For DTS patents, see <http://patents.dts.com>. Manufactured under license from DTS Licensing Limited. DTS and the DTS logo are registered trademarks or trademarks of DTS, Inc. in the United States and other countries. © 2020 DTS, Inc. ALL RIGHTS RESERVED.



What is Freeview Plus?

Freeview Plus is a new television service delivered via broadband providing a state of the art Electronic Program Guide (EPG) and seamless access to catch-up TV across the free-to-air networks with the simple press of a button.

How does it work?

First ensure the TV is connected to internet and an antenna system. Then when you're watching TV, you'll briefly see a prompt at the top left of the screen. Press the 'Green' button on your remote to launch Freeview Plus. More information about Freeview Plus can be found on <http://www.freeview.com.au/>