



## **SIDE-BY-SIDE REFRIGERATOR**

Use & Care Guide

## **REFRIGERADOR DE DOS PUERTAS**

Guía para el Uso y Cuidado

**Models/Modelos 41002, 41003, 41009**

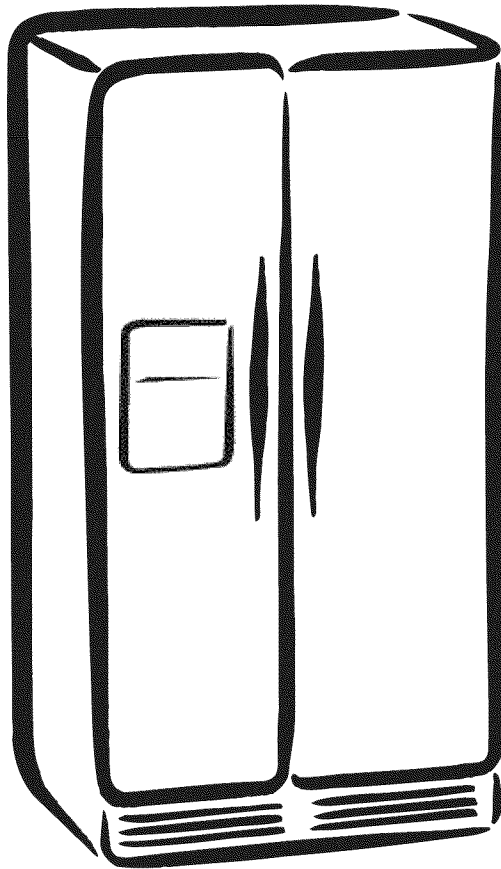

# TABLE OF CONTENTS

<b>English Version</b>	<b>2</b>	Turning Off the Ice Dispenser	20
<b>Spanish Version</b>	<b>51</b>	Selecting and Dispensing Ice	20
<b>Warranty</b>	<b>3</b>	Selecting and Dispensing Water	21
<b>Protection Agreements</b>	<b>4</b>	Cooling Off (Demo Mode)	21
<b>Important Safety Instructions</b>	<b>5</b>	Door Open Alarm	21
<b>CFC Refrigerant Disposal</b>	<b>7</b>	Calendar	21
<b>Grounding Requirements</b>	<b>7</b>	How to Enter a Calendar Memo	21, 22
<b>Parts and Features</b>	<b>8</b>	How to Enter a New Special Day	23
<b>Refrigerator Installation</b>	<b>9–16</b>	How to Change a Calendar Memo or Special Day	24
Getting Ready to Install	9	How to Delete a Calendar Memo or Special Day	25, 26
Clearances	9	Calendar Memo Alarm	26
Flooring	9	Temp Control	27
Unpacking Your Refrigerator	10	About the Automatic Icemaker	28
Supplied Parts	10	Setting Fast Freeze or Rapid Cool	29
Required Tools	10	Water Filter	29, 30
Refrigerator and Freezer Door Removal and Installation	11	Photo Album	31–34
Water Line Requirements	12	Message	35–37
Connecting to the Water Supply Line	12, 13	Settings	37–40
Installing the Water Filter	13, 14	Storing Food in the Refrigerator	41
Positioning and Leveling the Refrigerator	15	Storing Food in the Freezer	41
Making Minor Door Adjustments	16	Using the Doors	41
<b>Using Your Refrigerator</b>	<b>17–44</b>	Removing the Refrigerator/Freezer Accessories	42, 43
Digital Panel	17–40	<b>Care and Cleaning</b>	<b>44–46</b>
Setting the Time	17	Cleaning the Refrigerator	44, 45
Calibrating the Stylus Touch Point	18	Replacing the Interior Lights	45
Using Home	18	Changing the Water Filter	45
Using Slide Show	19	Power Interruptions	46
Using the Child Lock Function	19	When You Go on Vacation	46
Dispenser Controls	20	When You Move	46
Using the Dispenser Lighting	20	<b>Troubleshooting Guide</b>	<b>47–49</b>
Using the Dispenser Accent Lighting	20	<b>Customer Service</b>	<b>Back Cover</b>



## **REFRIGERATOR WARRANTY**

### **Kenmore Elite™ Limited Warranty**

When installed, operated, and maintained according to all instructions supplied with the product, if any non-expendable part of this appliance other than the sealed refrigerant system fails due to a defect in material and workmanship within one year from the date of purchase, call 1-800-4-MY-HOME® to arrange for free repair. This coverage applies for only 90 days from the date of purchase if this appliance is ever used for other than private family purposes.

If the sealed refrigerant system is defective within five years from the purchase date, call 1-800-4-MY-HOME® to arrange for free repair. This coverage applies for only one year from the date of purchase if this appliance is ever used for other than private family purposes.

#### **This warranty covers only defects in material and workmanship. Sears will NOT pay for:**

1. Expendable items that can wear out from normal use, including but not limited to filters, belts, light bulbs, and bags.
2. A service technician to instruct the user in correct product installation, operation, or maintenance.
3. A service technician to clean or maintain this product.
4. Damage to or failure of this product if it is not installed, operated, or maintained according to all the instructions supplied with the product.
5. Damage to or failure of this product resulting from accident, abuse, misuse, or use for other than its intended purpose.
6. Damage to or failure of this product caused by the use of detergents, cleaners, chemicals, or utensils other than those recommended in all instructions supplied with the product.
7. Damage to or failure of parts or systems resulting from unauthorized modification made to this product.

#### **Disclaimer of implied warranties, limitation of remedies**

Customer's sole and exclusive remedy under this limited warranty shall be product repair as provided herein. Implied warranties, including warranties of merchantability or fitness for a particular purpose, are limited to one year or the shortest period allowed by law. Sears shall not be liable for incidental or consequential damages. Some states do not allow the exclusion or limitation of incidental or consequential damages, or limitations on the duration of implied warranties of merchantability or fitness, so these exclusions or limitations may not apply to you.

This warranty applies only while this appliance is used in the United States.

This warranty gives you specific legal rights, and you may also have other rights which vary from state to state.

**Sears, Roebuck and Co., Hoffman Estates, IL 60179**

# PROTECTION AGREEMENTS

## Master Protection Agreements

*Congratulations on making a smart purchase.* Your new Kenmore® product is designed and manufactured for years of dependable operation. But like all products, it may require preventive maintenance or repair from time to time. That's when having a Master Protection Agreement can save you money and aggravation.

The Master Protection Agreement also helps extend the life of your new product. Here's what the Agreement includes:

**Parts and labor** needed to help keep products operating properly **under normal use**, not just defects. Our coverage goes **well beyond the product warranty**. No deductibles, no functional failure excluded from coverage—**real protection**.

**Expert service** by a force of more than **10,000 authorized Sears service technicians**, which means someone you can trust will be working on your product.

**Unlimited service calls and nationwide service**, as often as you want us, whenever you want us.

**"No-lemon"** guarantee—replacement of your covered product if four or more product failures occur within twelve months.

**Product replacement** if your covered product can't be fixed.

**Annual Preventive Maintenance Check** at your request—no extra charge.

**Fast help by phone**—we call it **Rapid Resolution**—phone support from Sears representatives on all products. Think of us as a "talking owner's manual."

**Power surge protection** against electrical damage due to power fluctuations.

**\$250 Food Loss Protection** annually for any food spoilage that is the result of mechanical failure of any covered refrigerator or freezer.

**Rental reimbursement** if repair of your covered product takes longer than promised.

**10% discount** off the regular price of any noncovered repair service and related installed parts.

Once you purchase the Agreement, a simple phone call is all that it takes for you to schedule service. You can call anytime day or night, or schedule a service appointment online.

The Master Protection Agreement is a risk-free purchase. If you cancel for any reason during the product warranty period, we will provide a full refund or a prorated refund anytime after the product warranty period expires. Purchase your Master Protection Agreement today!

**Some limitations and exclusions apply.**

**For prices and additional information in the U.S.A., call 1-800-827-6655.**

### Sears Installation Service

*For Sears professional installation* of home appliances, garage door openers, water heaters, and other major home items, in the U.S.A. **call 1-800-MY-HOME®.**

## PRODUCT RECORD

In the space below, record the date of purchase, model, and serial number of your product. You will find the model and serial number printed on an identification label located on the right-hand side of the refrigerator compartment. Have these items of information available whenever you contact Sears concerning your product.

Model No. \_\_\_\_\_

Date of Purchase \_\_\_\_\_

Serial No. \_\_\_\_\_

Dealer \_\_\_\_\_

Save these instructions and attach your sales receipt for future reference.

# IMPORTANT SAFETY INSTRUCTIONS

## BASIC SAFETY PRECAUTIONS

This guide contains many important safety messages. Always **read and obey** all safety messages.



This is the safety alert symbol. It alerts you to safety messages that inform you of hazards that can kill or hurt you or others, or cause damage to the product.

All safety messages will be preceded by the safety alert symbol and the hazard signal word DANGER, WARNING, or CAUTION. These words mean:

### **DANGER**

You **will** be killed or seriously injured if you don't follow instructions.

### **WARNING**

You **can** be killed or seriously injured if you don't follow instructions.

### **CAUTION**

Indicates an imminently hazardous situation which, if not avoided, **may** result in minor or moderate injury, or product damage only.

All safety messages will identify the hazard, tell you how to reduce the chance of injury, and tell you what can happen if the instructions are not followed. Keep this guide in a safe place for future reference.

## **DANGER: RISK OF CHILD ENTRAPMENT**

Child entrapment and suffocation are not problems of the past. Junked or abandoned refrigerators are still dangerous...even if they will sit for "just a few days." If you are getting rid of your old refrigerator, please follow the instructions at right to help prevent accidents.

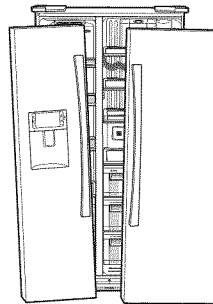

### **BEFORE YOU THROW AWAY YOUR OLD REFRIGERATOR OR FREEZER**

- Take off the doors.
- Leave the shelves in place so that children may not easily climb inside.

## **WARNING**

**To reduce the risk of fire, electric shock, or injury to persons when using your product, basic safety precautions should be followed, including the following.**

**Read all instructions before using this appliance.**

- DO NOT plug several appliances into the same power receptacle. Large appliances draw a lot of power. Powering more than one appliance or machine from a single power source could cause overheating and cause a fire.
- Make sure that the power plug is not kinked or damaged by the back of the refrigerator. A damaged power plug may overheat and cause a fire.
- DO NOT spray water directly into or on the outside of the refrigerator/freezer drawer. Water could get into the interior machine parts and cause electric shock.
- DO NOT use aerosols near the refrigerator. Aerosols used near the refrigerator may cause an explosion or fire.
- DO NOT put undue stress on the power cord or place heavy articles on it. Placing heavy articles on the power cord creates the risk of explosion or fire.
- DO NOT insert the power plug with wet hands. It may cause electric shock.
- DO NOT put a container filled with water on the refrigerator. If it spills, it may cause fire or electric shock.

## IMPORTANT SAFETY INSTRUCTIONS

### WARNING

- DO NOT install the refrigerator in a damp place or place where it may come in contact with water. Wet and/or deteriorated insulation of the internal electrical parts may cause electric shock or fire.
- DO NOT store volatile or flammable substances in the refrigerator. Storing benzene, thinner, alcohol, ether, LP gas, and other such products may cause explosions.
- DO NOT disassemble or repair the refrigerator by yourself. You may run the risk of fire, appliance malfunctions, and/or personal injury. Call your nearest service center for help from a qualified service technician.
- Unplug the refrigerator before changing the interior light. Changing the light while the refrigerator is plugged in may cause electric shock.
- The refrigerator must be safely grounded. ALWAYS make sure that you have grounded the refrigerator before attempting to investigate or repair any part of the appliance. Power leakages can cause severe electric shock.
- NEVER use gas pipes, telephone lines, or other potential lightning attractors as an electrical ground. Improper use of the grounding plug can result in a risk of electric shock. If it is necessary to use an extension cord to power the refrigerator, use only a 3-wire extension cord that has a 3-blade ground plug and a 3-slot receptacle that will accept the plug on the appliance. The marked rating of the extension cord should be AC 115V/120V, 15A, or more. Additionally, if a grounding adapter is used, make sure the receptacle box is also fully grounded.

### CAUTION

- Use good judgment when filling the refrigerator with food and drinks. In an overfull refrigerator, heavy, fragile, bulky, or breakable items may fall out and cause personal injury and/or damage to surrounding objects.
- DO NOT put bottles or glass containers in the freezer. When the contents freeze and then expand, the glass may break and cause personal injury or leave dangerous glass shards in the freezer.
- If the electrical wall socket is loose, do not insert the power plug. There is a risk of electric shock or fire. Have the plug looked at by a licensed electrician.
- NEVER unplug your refrigerator by pulling on the power cord.
  - Always grip the power plug firmly and pull straight out from the outlet. Yanking or pulling on the power cord may cause a short circuit, fire, and/or electric shock.
  - A damaged power cord must be replaced by the manufacturer, a certified service agent, or qualified service personnel.
- DO NOT store articles on the top of the appliance. When you open or close the door, the articles may fall and cause personal injury and/or damage to surrounding objects.
- DO NOT store pharmaceutical products, scientific materials, and temperature-sensitive products in the refrigerator. Products that require exact temperature controls should not be stored in the refrigerator.
- DO NOT allow children to climb, stand, or hang on shelves and handles of the refrigerator. DO NOT sit on the freezer door. DO NOT allow children to climb into the freezer. They could damage the refrigerator and/or seriously injure themselves.
- If you notice a chemical or burning plastic smell or see smoke, unplug the refrigerator immediately and contact your Sears Service Center.
- After your refrigerator is in operation, do not touch the cold surfaces in the freezer compartment. Particularly when hands are damp or wet, skin may adhere to these extremely cold surfaces. Skin may stick to the surface and you may get frostbite.
- DO NOT put your hands under the appliance. Any sharp edges may cause personal injury.
- NEVER put fingers or other objects into the water dispenser hole or ice chute. It may cause personal injury and/or material damage.
- If the refrigerator will not be used for a long period of time (for example, over several months), unplug the power from the wall. Over time, deterioration in the power cord insulation may cause fire.
- DO NOT use a wet or damp cloth when cleaning plug.
- Remove any dust or foreign matter from the power plug pins. A dirty power plug can increase the risk of fire.
- If the refrigerator is disconnected from the power supply, you should wait for at least five minutes before plugging it back in.
- DO NOT place the refrigerator directly in sunlight.
- The appliance must be positioned for easy access to the power source.

## IMPORTANT SAFETY INSTRUCTIONS

### ⚠ CAUTION

- If you have a long vacation planned, empty the refrigerator and turn it off. Wipe excess moisture from the inside and leave the doors open to keep odor and mold from developing.
- **Service Warranty and Modification**  
Any changes or modifications performed by a third party on this finished appliance are not covered under Sears warranty service, nor can Sears be responsible for safety issues that result from third-party modifications.
- This appliance is not intended for use by small children or infirm persons without capable, adult supervision. Small children should be supervised when using the appliance.
- DO NOT block air holes in the refrigerator. If the air holes are blocked, especially with a plastic bag, the refrigerator can become overcooled. Prolonged periods of overcooling will break the water filter and cause water leakage.

## SAVE THESE INSTRUCTIONS

### CFC REFRIGERANT DISPOSAL

Your old refrigerator may have a cooling system that used CFCs (chlorofluorocarbons). CFCs are believed to harm stratospheric ozone.

If you are throwing away your old refrigerator, make sure the CFC refrigerant is removed for proper disposal by a qualified servicer. If you intentionally release the CFC refrigerant, you can be subject to fines and imprisonment under provisions of environmental legislation.

### GROUNDING REQUIREMENTS

**IMPORTANT:** Please read carefully.

#### TO CONNECT ELECTRICITY

### ⚠ WARNING

#### Electrical Shock Hazard

**FOR PERSONAL SAFETY**, this appliance must be properly grounded. Have the wall outlet and the circuit checked by a qualified electrician to make sure the outlet is properly grounded.

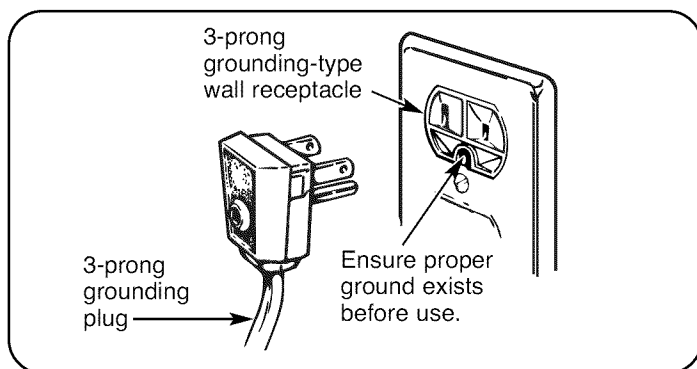

#### RECOMMENDED GROUNDING METHOD

The refrigerator should always be plugged into its own individual properly grounded electrical outlet rated for 115 volts, 60 Hz, AC only and fused at 15 or 20 amperes. This provides the best performance and also prevents overloading house wiring circuits which could cause a fire hazard from overheated wires. It is recommended that a separate circuit serving only this appliance be provided. Use a receptacle which cannot be turned off with a switch or pull chain. Do not use an extension cord.

Where a standard two-prong wall outlet is encountered, it is your personal responsibility and obligation to have it replaced with a properly grounded three-prong wall outlet.

**Do not, under any circumstances, cut or remove the third (ground) prong from the power cord.**

#### USE OF EXTENSION CORDS

**Because of potential safety hazards under certain conditions, we strongly recommend against the use of an extension cord.** However, if you still elect to use an extension cord, it is absolutely necessary that it be a UL-listed, 3-wire grounding-type appliance extension cord having a grounding-type plug and outlet and an electrical rating of the cord of 15 amperes (minimum) and 120 volts.

Use of an extension cord will increase the clearance needed for the back of the refrigerator.

## PARTS AND FEATURES

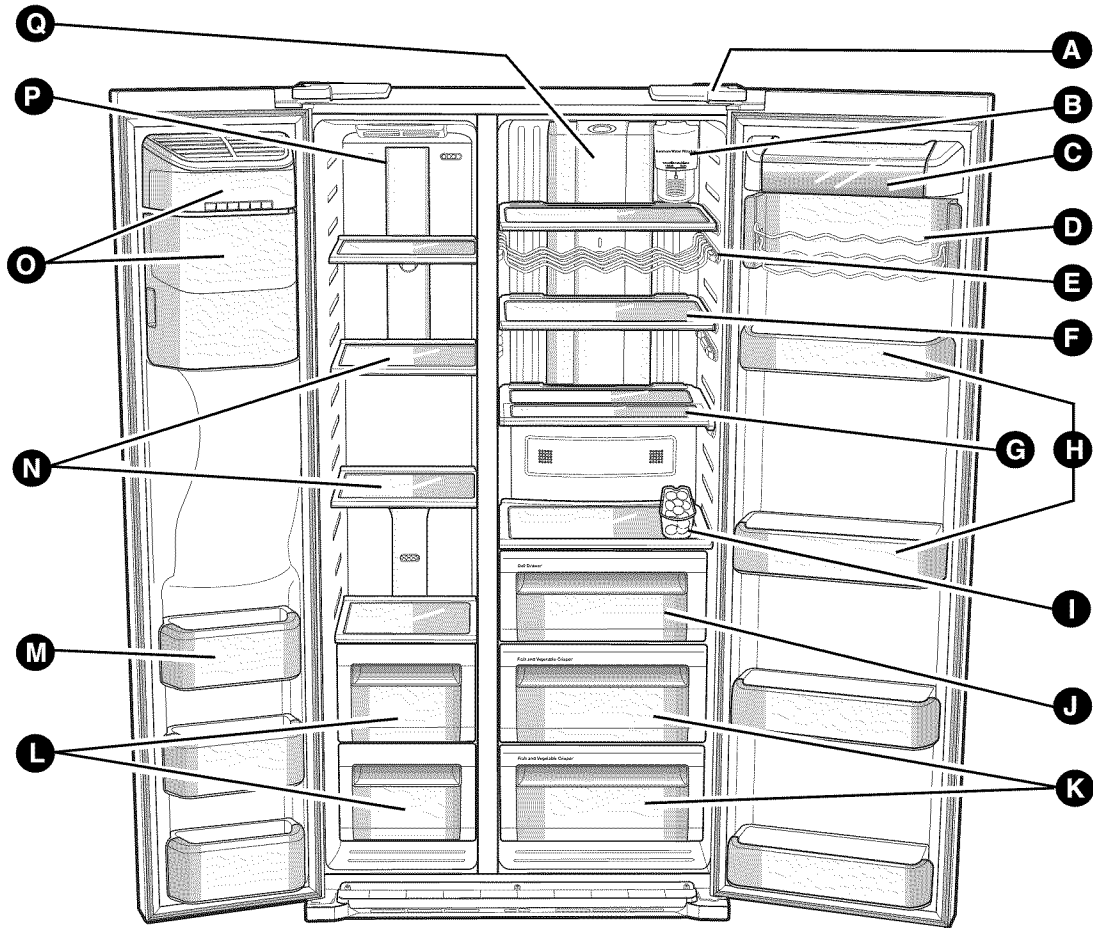

Use this section to become more familiar with the parts and features. Page references are included for your convenience.

**NOTE:** The refrigerator you have purchased may have some or all of the items listed below.

- |   |   |
|---|---|
| <b>A</b> Auto Door Closer (p. 41)           | <b>J</b> Deli Drawer (p. 41, 42)                  |
| <b>B</b> Water Filter (p. 45)               | <b>K</b> Fruit and Vegetable Crispers (p. 41, 42) |
| <b>C</b> Dairy Bin (p. 41)                  | <b>L</b> Freezer Drawers (p. 41, 42)              |
| <b>D</b> Tilt Can Carry (p. 41)             | <b>M</b> Freezer Door Bins (p. 41, 42)            |
| <b>E</b> Optional Wine Rack (p. 41)         | <b>N</b> Slide-Shelves (p. 41)                    |
| <b>F</b> Glass Shelves (p. 41, 42)          | <b>O</b> Icemaker and Ice Bucket (p. 41, 43)      |
| <b>G</b> Foldable Shelf (p. 41)             | <b>P</b> Freezer Light (p. 45)                    |
| <b>H</b> Refrigerator Door Bins (p. 41, 42) | <b>Q</b> Refrigerator Light (p. 45)               |
| <b>I</b> Egg Container (p. 41)              |   |

### NOTES:

- The door handle may become loose over time. If this happens, tighten the bolts found on the inside of the door.
- If you close one door with a lot of force, the other door may open.

# REFRIGERATOR INSTALLATION

## GETTING READY TO INSTALL THE REFRIGERATOR

Congratulations on your purchase of the Kenmore Elite™ Side-By-Side Refrigerator. We hope you enjoy the many state-of-the-art features and efficiencies that this new appliance offers.

### Selecting the best location for the refrigerator.

- A location with easy access to the water supply.
- A location without direct exposure to sunlight.
- A location with level (or nearly level) flooring.
- A location with enough space for the refrigerator doors to open easily.
- Allow sufficient space for air circulation of the internal cooling system. If the refrigerator is not level or does not have enough space, the internal cooling system may not work properly.

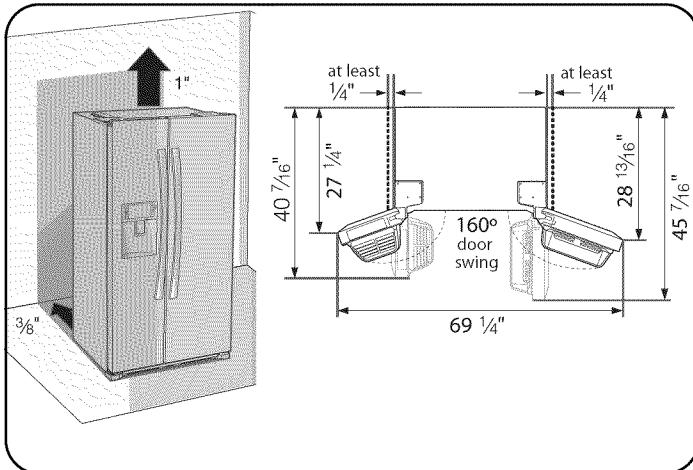

First thing! Make sure that you can easily move your refrigerator to its final location by measuring doorways (both width and height), thresholds, ceilings, stairways, etc.

The following chart details the exact height and depth of your new Kenmore Elite™ Side-By-Side Refrigerator.

MODEL	41002, 41003, 41009
Capacity (Cu. Ft.)	24.1
Dimensions (inch)	
Width, Overall	35 <sup>15</sup> / <sub>16</sub>
Cabinet Only	35 <sup>3</sup> / <sub>4</sub>
Height, Overall	70
Cabinet Only	68 <sup>5</sup> / <sub>8</sub>
Depth, Overall	30
Cabinet Only	23 <sup>5</sup> / <sub>8</sub>

## CLEARANCES

- Allow clearance to the right, left, back, and top when installing. (See drawing in column 1.) This will help reduce power consumption and keep your energy bills lower.
- Do not install the refrigerator where the temperature will go below 50°F (10°C).
- Make sure to disconnect the water supply line BEFORE removing the freezer door. See “Refrigerator and Freezer Door Removal and Installation” on page 11 to avoid damage.

## CAUTION

To prevent damage to the floor while moving the refrigerator, always make sure the front leveling legs are in the up position (above the floor). Refer to “Positioning and Leveling the Refrigerator” on page 15.

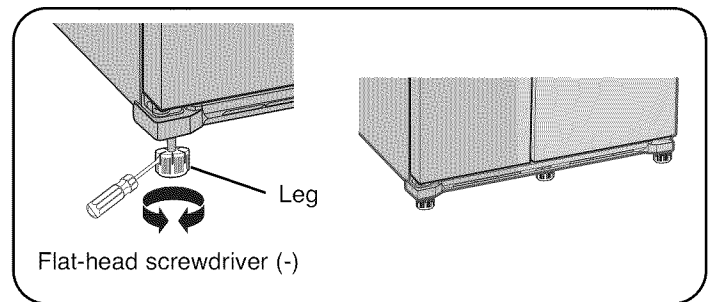

## FLOORING

For proper installation, this refrigerator must be placed on a level surface of hard material that is the same height as the rest of the flooring. This surface should be strong enough to support a fully loaded refrigerator or approximately 309 lbs (140 kg). To protect the finish of the flooring, cut a large section of the cardboard carton and place under the refrigerator where you are working. When moving, be sure to pull the unit straight out and push the unit straight in.

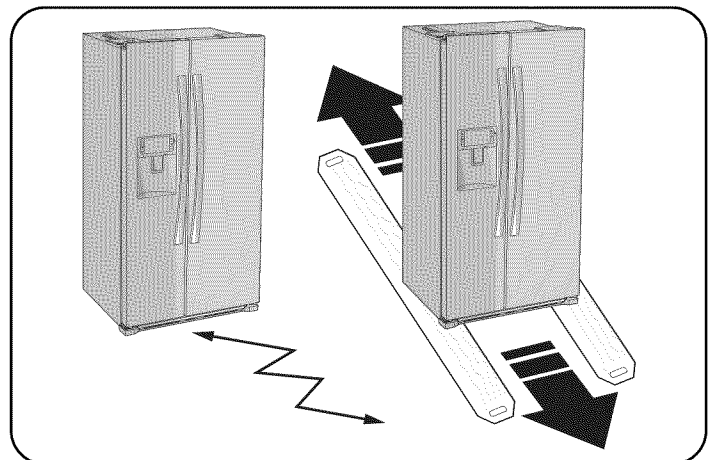

# REFRIGERATOR INSTALLATION

## ⚠ WARNING

### Excessive Weight Hazard

Use two or more people to move and install the refrigerator. Failure to do so can result in back or other injury.

## UNPACKING YOUR REFRIGERATOR

Remove tape and any temporary labels from the refrigerator before using. Do not remove any warning-type labels, the model and serial number label, or the tech sheet that is attached to the back wall of the refrigerator.

To remove any remaining tape or glue, rub the area briskly with your thumb. Tape or glue residue can also be easily removed by rubbing a small amount of liquid dish soap over the adhesive with your fingers. Wipe with warm water and dry.

Do not use sharp instruments, rubbing alcohol, flammable fluids, or abrasive cleansers to remove tape or glue. These products can damage the surface of the refrigerator. For more information, see the "Important Safety Instructions" section.

Refrigerator shelves are installed in the shipping position. Please reinstall the shelves according to your individual storage needs.

## ⚠ WARNING

### When Moving Your Refrigerator:

Your refrigerator is heavy. When moving the refrigerator for cleaning or service, be sure to protect the floor. Always pull the refrigerator straight out when moving it. Do not wiggle or walk the refrigerator when trying to move it, as floor damage could occur.

## ⚠ WARNING

### Explosion Hazard

Keep flammable materials and vapors, such as gasoline, away from the refrigerator. Failure to do so can result in death, explosion, or fire.

- To reduce the risk of electric shock, do not install the refrigerator in a wet or damp area.
- Select a place where a water supply can be easily connected for the automatic icemaker.

## ⚠ CAUTION

Avoid placing the refrigerator near a heat source, direct sunlight, or moisture.

## SUPPLIED PARTS

The following parts should be supplied with the refrigerator. Please verify before installing.



Water filter  
(DA29-00003B)

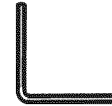

Hex wrench  
(DA80-00002C)



Compression fitting  
(DA62-00305A)



Compression nut  
(DA74-00070B)



Screw  
(6001-000541)

## REQUIRED TOOLS

The following tools are needed to install and adjust the refrigerator.



Phillips-head  
screwdriver



Flat-head  
screwdriver



Wrench



Pliers



Allen wrench (3/16")

# REFRIGERATOR INSTALLATION

## REFRIGERATOR AND FREEZER DOOR REMOVAL AND INSTALLATION

If the refrigerator is too large to pass through your doorway easily, you can remove the refrigerator and freezer doors.

1. Open the refrigerator and freezer door. Remove the 3 screws (1) and the front leg cover (2) from the front-bottom of the refrigerator. Close the refrigerator and freezer doors.

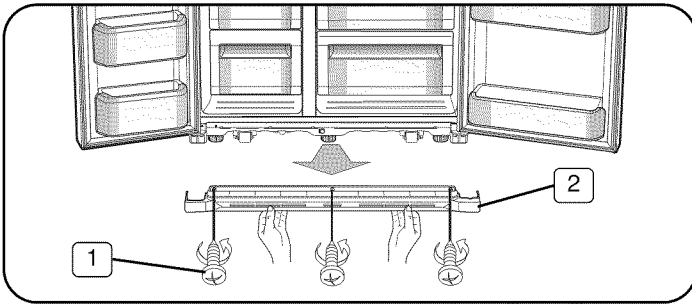

2. Remove 2 clips from the 2 couplers (5 and 6). Disconnect the 2 water supply lines (3 and 4) from the 2 couplers (5 and 6) under the freezer door. Press the coupler while pulling the water line to disconnect.  
**NOTE:** Do not cut the water line to remove it.

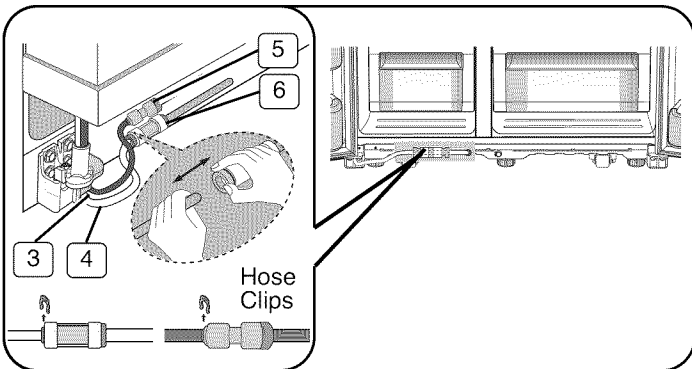

3. With the doors closed, remove 8 screws (7) securing the 2 upper hinge covers (8 and 9) with a flat-head screwdriver. Carefully disconnect any wire connector (10) attached to the upper hinge cover (9) and remove the upper hinge covers (8 and 9).

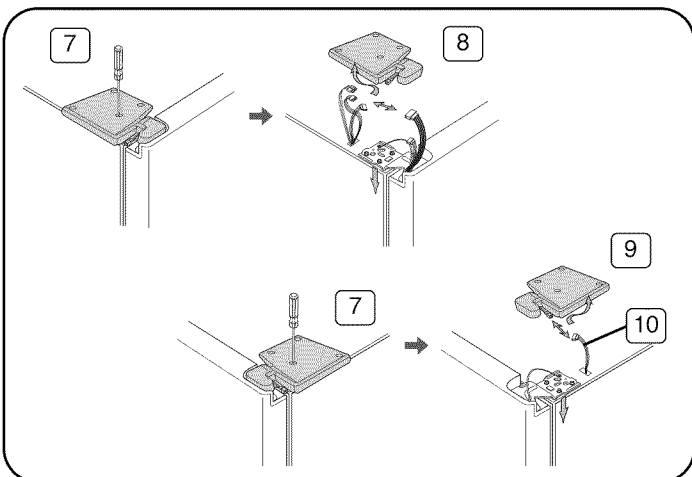

To remove the freezer door:

4. Disconnect the 3 wire connectors (11) by gently pulling them apart at the connectors.

## ⚠ CAUTION

Support the door during upper hinge removal to prevent possible personal injury and/or product damage from a falling, unsupported door.

5. Remove the ground screw (12) and disconnect the freezer ground wire (13). Remove the remaining 3 hinge screws (14) and the upper hinge (15) from the top of the refrigerator.

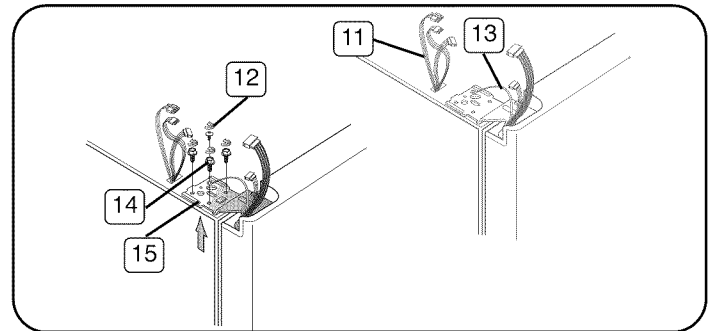

6. Lift the freezer door (16) straight up to disengage it from the bottom hinge (17) and carefully place the door to one side.  
**NOTE:** Be careful not to pinch the water tubing and wire harness during door removal.

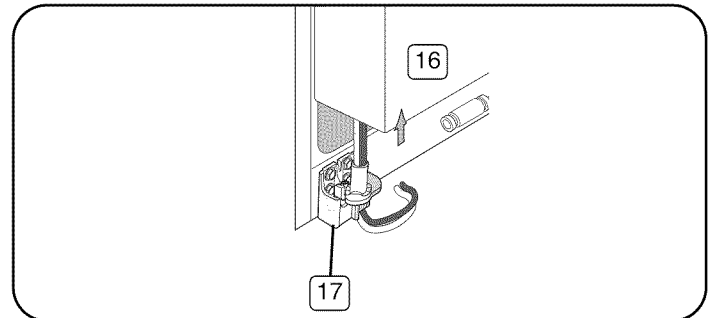

7. Lift bottom hinge (18) straight up to separate it from the bottom hinge bracket (19). Remove 4 hinge screws (20) to remove the bottom hinge bracket (19) from the bottom-front freezer frame.

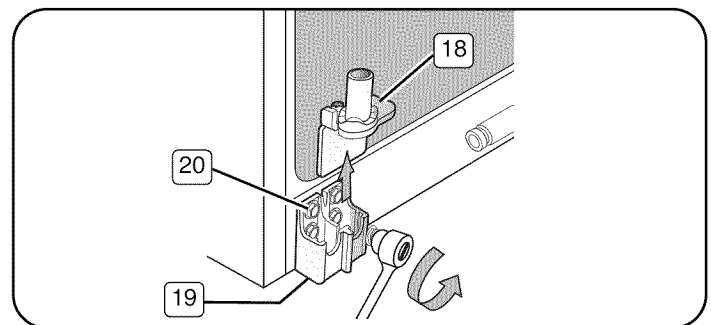

# REFRIGERATOR INSTALLATION

To remove the refrigerator door:

## ⚠ CAUTION

Support the door during upper hinge removal to prevent possible personal injury and/or product damage from a falling, unsupported door.

8. Remove the ground screw (12) and disconnect the refrigerator ground wire (21). Remove the remaining 3 hinge screws (14) and the upper hinge (22) from the top of the refrigerator.

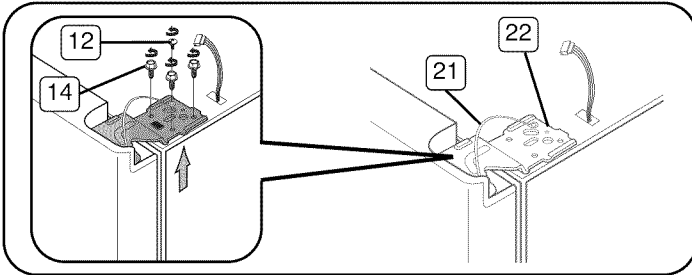

9. Lift the refrigerator door (23) straight up to disengage it from the bottom hinge (24) and carefully place the door to one side.

**NOTE:** Keep track of all loose parts to prevent misplacing or losing them during disassembly.

10. Lift bottom hinge (24) straight up to separate it from the bottom hinge bracket (25).

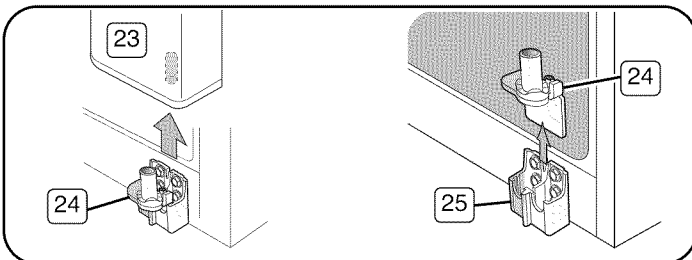

11. Reattach the refrigerator and freezer doors by reversing the order of the steps 10 to 3.

### Reattaching the water supply lines:

1. The water supply line must be fully inserted to the marked line to prevent water leakage from the dispenser.

**NOTE:** The water supply lines are color-coordinated, so the line color should always match. One supplies the icemaker and the other supplies the water dispenser.

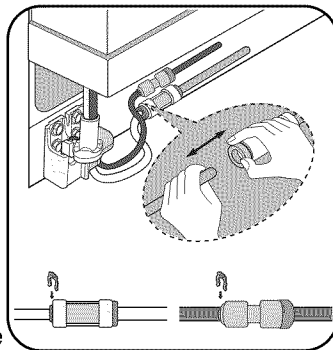

2. Insert the 2 clips and check that each clip holds the line firmly.
3. Install the front leg cover (2) and secure with 3 screws.

## WATER LINE REQUIREMENTS

A water dispenser is one of the helpful features on your new Kenmore Elite™ Side-By-Side Refrigerator. To help promote better health, the water filter removes unwanted particles from your water. However, it does not sterilize or destroy microorganisms. You may need to purchase a water purifying system to do that.

In order for the icemaker to operate properly, a water pressure of 20~125 psi (pounds per square inch) is required.

Under normal conditions, a 170-cc (5.75-oz.) cup can be filled in 10 seconds.

If the refrigerator is installed in an area with low water pressure (below 20 psi), you can install a booster pump to compensate for the low pressure.

Make sure the water storage tank inside the refrigerator is properly filled. To do this, press the water dispenser lever until the water runs from the water outlet.

**NOTE:** Water line installation kits are available at extra cost from your dealer. We recommend using a water supply kit that contains copper tubing.

## CONNECTING TO THE WATER SUPPLY LINE

1. Shut off the main water supply line and make sure the icemaker is turned off.

2. Locate the nearest cold water line (1).

**NOTE:** Only connect to a drinkable cold water source.

3. Install pipe clamp (2) on cold water line (1).

4. Cover threads of shut-off valve (4) with pipe thread tape or compound; then thread into pipe clamp (2) and cold water line (1).

5. Connect water line installation kit (3) to shut-off valve (4).

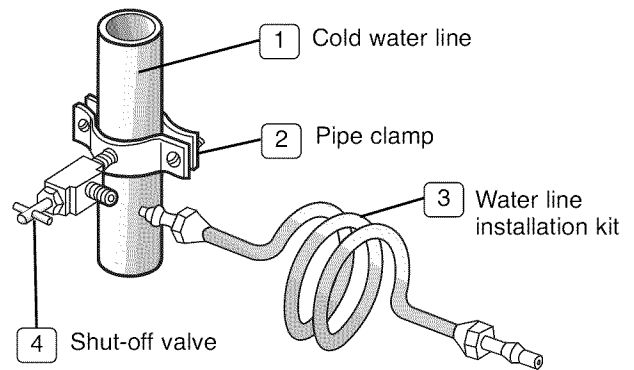

# REFRIGERATOR INSTALLATION

## CONNECTING THE WATER SUPPLY LINE TO THE REFRIGERATOR

There are several items that you need to purchase to complete this connection. You may find these items sold as a kit at your local hardware store.

- 1/4" compression nut
  - copper tubing
  - ferrule
1. Slip the compression nut (A) on the supplied plastic tubing (B).
  2. Tighten the compression nut (A) onto the 1/4" compression fitting.
    - Slip the compression nut (C) (not included) and ferrule (not included) on copper tubing (not included) as shown.
  3. Tighten the compression nut onto the compression fitting. Do not overtighten the compression nut (C).

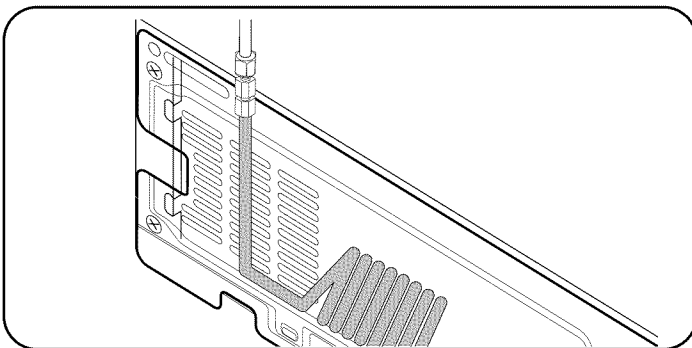
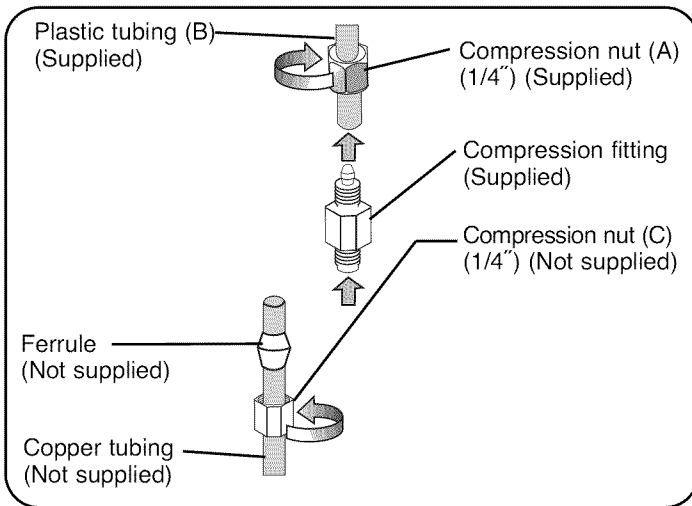

4. Turn on water and check for any leakage.

## INSTALLING THE WATER FILTER

1. Remove the water filter cover (1).
2. Remove the fixed cap by turning it counterclockwise. Keep the cap in a safe place for later use if you don't use the filter.
3. Remove the water filter from the box and put a replacement indicator sticker on the filter as shown. Place the sticker on the filter that dates 6 months in the future. For example, if you install the water filter in March, put the "SEP" sticker on the filter to remind you to replace it in September. That way you'll know when it is time to replace the filter. Normally, a filter life is about 6 months.

**NOTE:** You should remove the upper glass shelf before installing water filters.

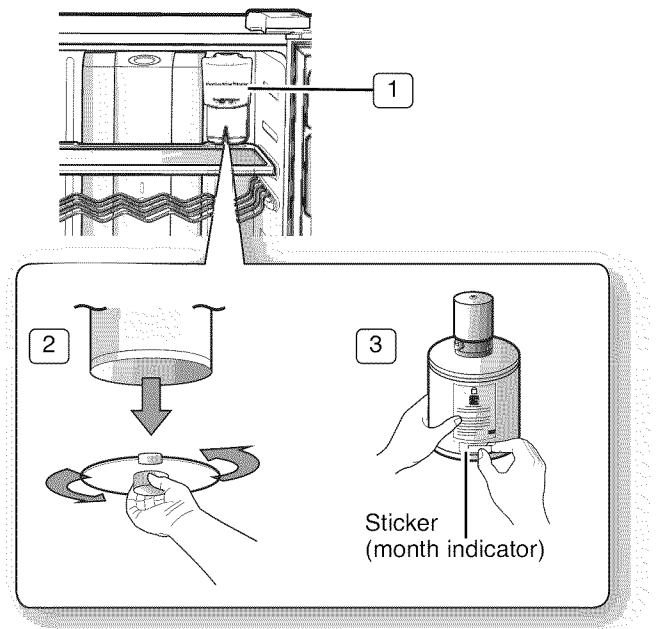

4. Remove the filter cap and insert the filter into the filter housing.
5. Slowly turn the water filter 90° clockwise to align with the printing mark on the cover, locking the filter in position. Make sure to align the water filter label mark with the center of the cover filter printing as illustrated. Remember, do not overtighten.

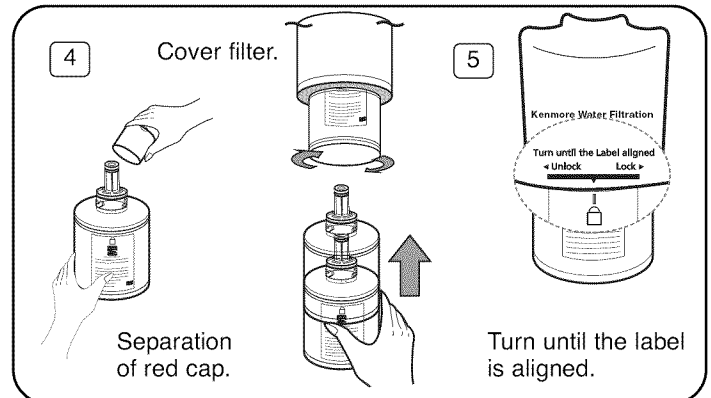

# REFRIGERATOR INSTALLATION

## Remove any residual matter inside the water supply line after installing the water filter.

1. Plug the refrigerator's power cord into a 3-prong grounded outlet.

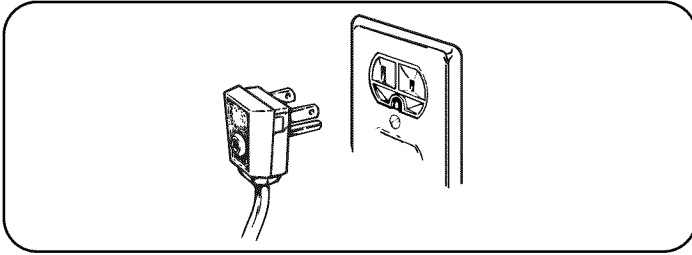

2. Turn ON the main water supply and turn ON the valve to the water supply line.
3. Flush 3 gallons (11.4 liters) of water through the dispenser (approximately 6 minutes). This removes any contaminants and purges any air in the water lines.
4. Additional flushing may be required in some households.
5. Open the refrigerator door and make sure there are no water leaks coming from the water filter.

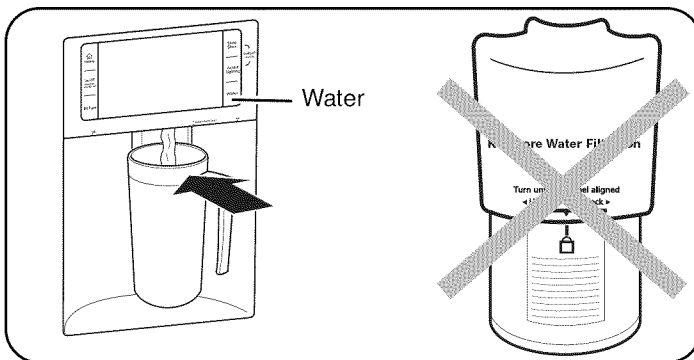

**NOTE:** Be sure to flush 3 gallons (11.4 liters) approximately 6 minutes). This purges any air in the water lines that could cause the dispenser to drip.

## Check the amount of water supplied to the icemaker.

1. Open the freezer door.
2. Lift the icemaker cover up and out to remove it from the freezer door.

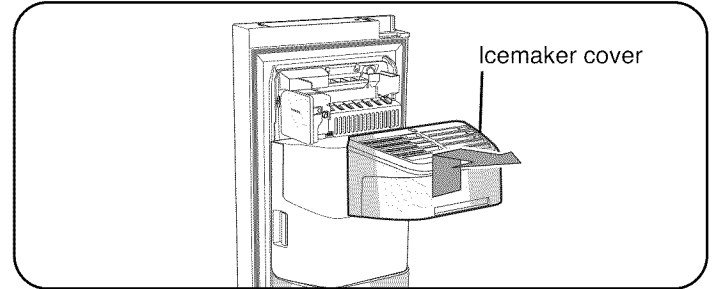

## ⚠ CAUTION

- It will take a few minutes to fill the icemaker with water.
  - Do not press the test button continuously when the tray is filled with ice or water. Water could overflow or ice jamming could occur.
  - When the bucket is not installed, the icemaker does not work.
  - If ICE OFF blinks on the LCD display panel, reinsert the bucket and/or make sure it is installed properly.
3. Press and hold the test button on the icemaker for 3 seconds. The icemaker will automatically fill with supplied tap water. After the icemaker has completed filling, check to make sure the amount of water is correct.

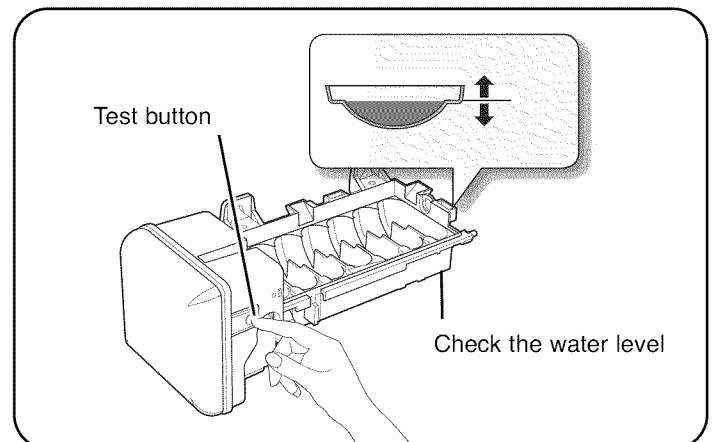

If the water level is too low, the ice cubes will be small. Contact a plumber to increase the water pressure to the refrigerator.

4. Replace the icemaker cover and close the freezer door.

# REFRIGERATOR INSTALLATION

## POSITIONING AND LEVELING THE REFRIGERATOR

Now that the refrigerator has been assembled and connected to a water supply source, position and level the refrigerator.

The refrigerator has three front leveling legs—one on the right, one on the left, and one in the middle. Adjust legs to alter tilt from front to back or side to side. If the refrigerator seems unsteady or you want the doors to close easier, adjust the refrigerator's tilt using the instructions below:

**NOTE:** Make sure the location meets all the requirements listed on page 9.

1. Move the refrigerator into its final position.
2. Open the refrigerator and freezer doors and remove the 3 screws and the front leg cover.

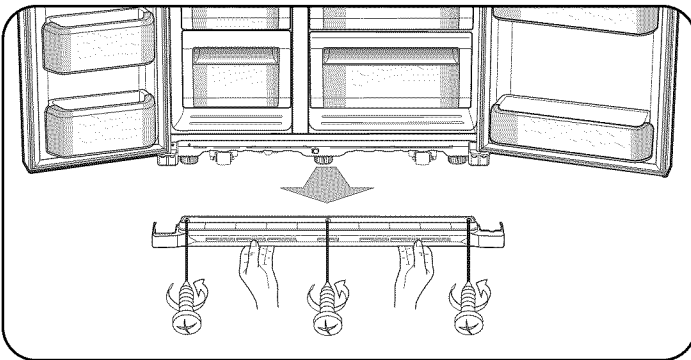

3. Place a level on the lower shelves or drawer covers. Check to make sure the refrigerator and freezer sections are level from side to side and front to back.

**NOTE:** Having someone push backward against the top of the refrigerator takes some weight off the leveling legs. This makes it easier to adjust the legs.

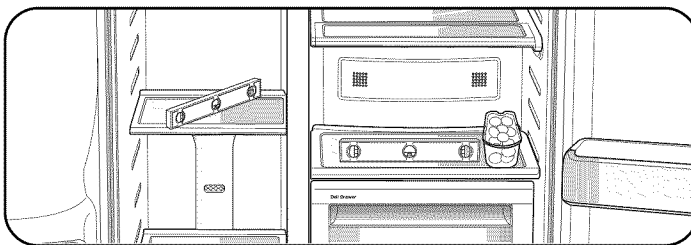

4. If it is not level, adjust the front leveling legs until the refrigerator is level. Using a flat-head screwdriver, turn the leg counterclockwise to extend the leg and raise the refrigerator at that point. Turn the leg clockwise to retract the leg and lower the refrigerator at that point. It may take several turns of the leveling leg to adjust the tilt of the refrigerator.

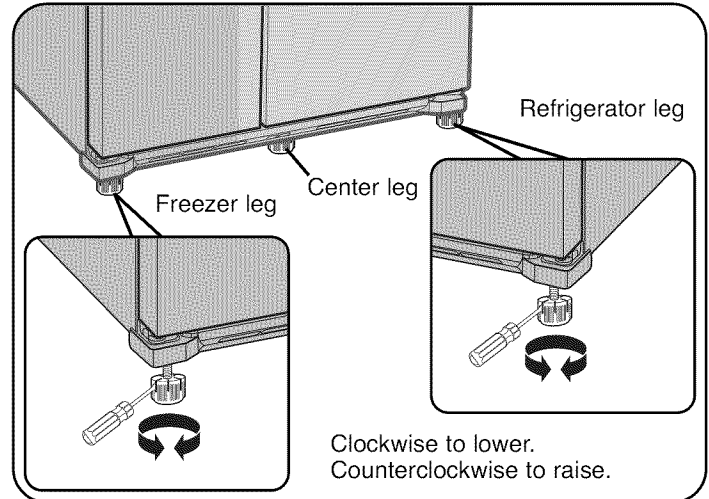

5. Replace the front leg cover and secure with 3 screws.
6. Close the refrigerator and freezer doors.

# REFRIGERATOR INSTALLATION

## MAKING MINOR DOOR ADJUSTMENTS

Remember, a level refrigerator is necessary for getting the doors perfectly even. If you need help, review the previous section on leveling the refrigerator.

When the freezer door is higher than the refrigerator door, adjust the refrigerator leg to level the two doors.

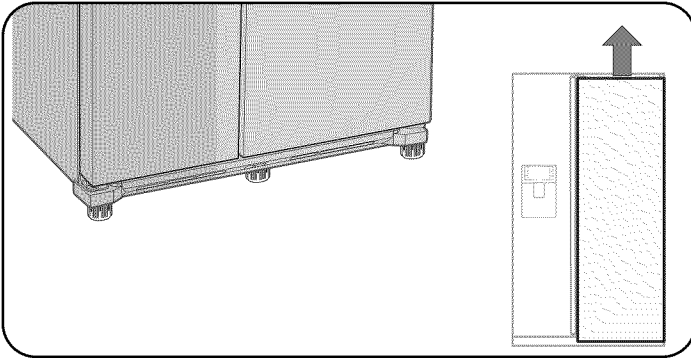

The following process is used when correcting the level of either door.

1. Open the refrigerator and freezer doors and remove the 3 screws and the front leg cover.

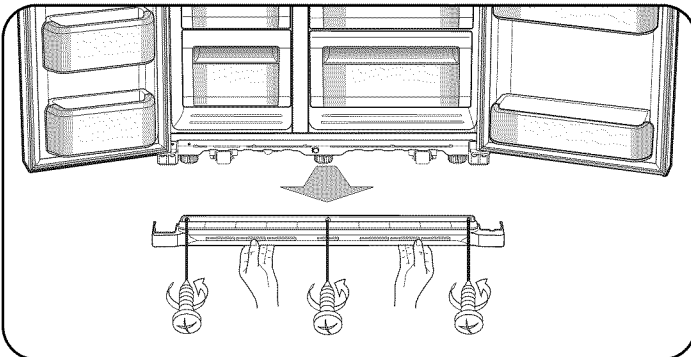

2. Use an Allen wrench (1) to loosen the bolt (2) and nut (3) on top of the lower hinge (4). Unthread the nut to the upper end of the bolt.

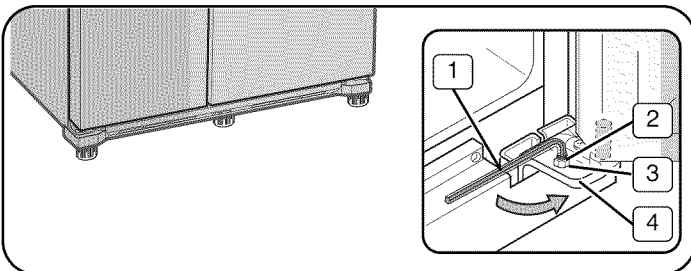

3. Using the Allen wrench (1), turn the bolt (2) clockwise to raise the door or counterclockwise to lower the door. Close the doors to check the level. Repeat step 3 until the doors are level.

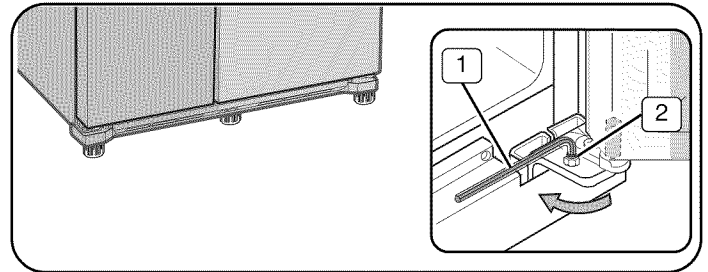

4. After the door is adjusted and the doors are leveled, thread the nut (3) down the bolt (2) until it touches the lower hinge (4). Tighten the bolt with the Allen wrench (1) to lock the nut and screw in place.

**NOTE:** If the nut and bolt are not securely tightened, they can come loose, causing the doors to be misaligned.

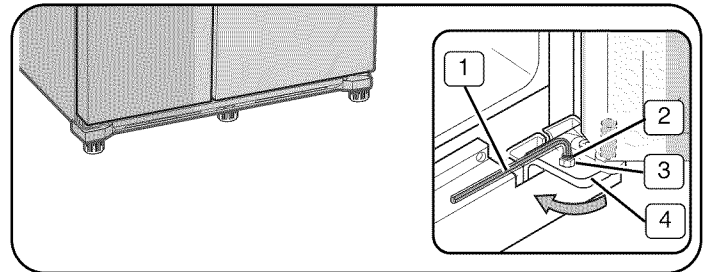

5. Replace the front leg cover and secure with 3 screws.

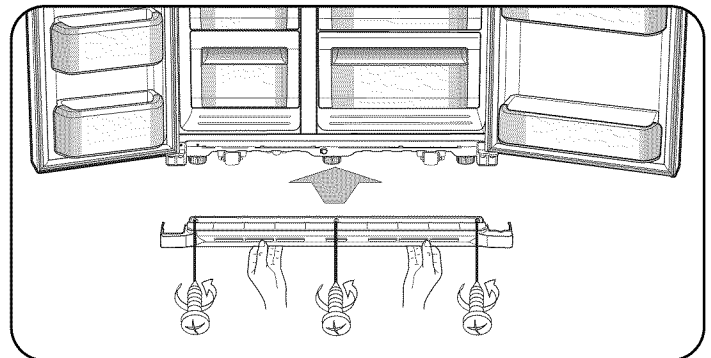

6. Close the refrigerator and freezer doors.

# USING YOUR REFRIGERATOR

## DIGITAL PANEL

The digital panel on the freezer door is a Graphic User Interface (GUI). This panel with LCD screen provides an easy-access interface for the user. The touch screen allows the user to access all display functions, including an interactive message board system.

The following chart provides important operating information and specifications for the digital panel:

FUNCTION	DESCRIPTION
Processor	Samsung S3C2440A 400 MHz
RAM	SDRAM (64 MB)
ROM	NAND Flash (128 MB)
OS	Windows CE 5.0
Display	800 x 480 7" TFT-LCD
Interface	Secure Digital (SD) Card Slot

The panel has six touch buttons on the sides of the panel. These buttons perform the following operations when they are touched by a finger.

**NOTE:** Buttons are very sensitive. They can be triggered by just brushing off the panel.

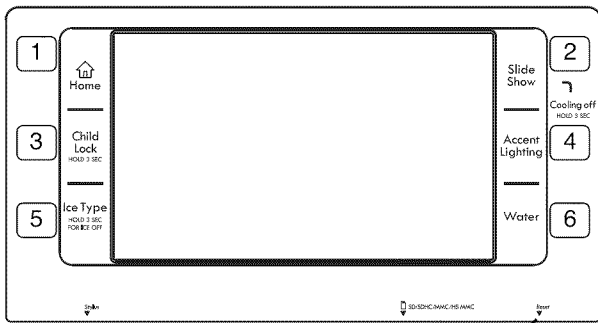

Display reset button

1. **Home** – Brings up the initial screen view showing the refrigerator's main functions.

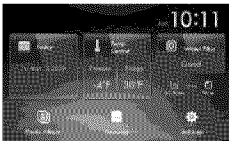

2. **Slide Show** – Use this function to see images saved in the electronic photo album.



3. **Child Lock** – When pressed for more than 3 seconds, it activates the child lock option.

4. **Accent Lighting** – Turns the accent lamp ON and OFF.
5. **Ice Type/Ice Off** – Allows you to select the type of ice being dispensed. This button toggles between cubed and crushed ice. When pressed for more than 3 seconds, it will turn OFF the icemaker.



6. **Water** – Press this button to dispense water from the dispenser.

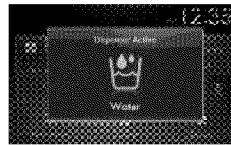

When the refrigerator is plugged in or the display reset button is pressed, the "Current Date/Time" screen will be displayed.

## Setting the Time

1. Choose the desired date and time by pressing the < or > buttons on the screen.
2. Press the OK button on the screen to apply the new date and time.



3. When the OK button is pressed, the "Home" screen will be displayed, showing the new set date and time.



## Calibrating the Stylus Touch Point

The stylus touch point can be calibrated to best meet the user's needs. To adjust the stylus touch point on the touch screen:

1. Press the Settings button on the "Home" screen. The display will show the adjustable settings on the screen.



2. Press the Touch Screen Correction button. The display will show pointer instructions and a "+" on the screen.

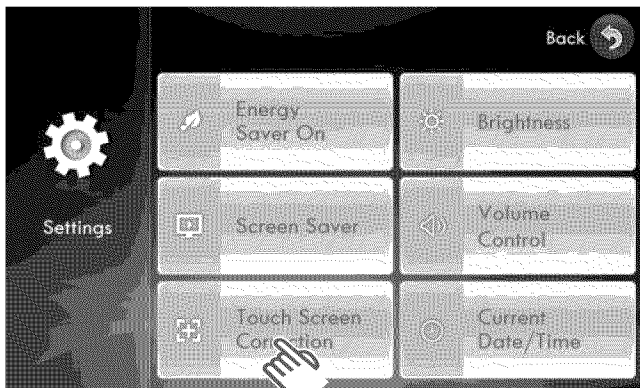

3. Using the stylus, lightly press on the center of the "+" mark. The "+" mark will move on the screen. Repeat this step 3 until the "+" mark no longer appears.

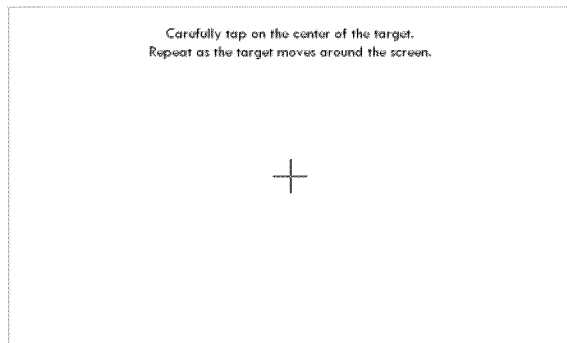

4. To save the new calibration data, touch the screen within 30 seconds of the last "+" mark. This will save the new settings and return the screen back to the "Settings" screen.

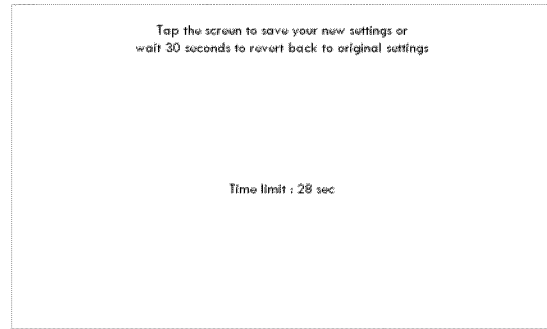

**NOTE:** If the screen is not touched within 30 seconds, the settings will revert back to the existing settings.

## Using Home

When the Home button is pressed, the screen displays the "Home" screen.

1. Press the Home button.

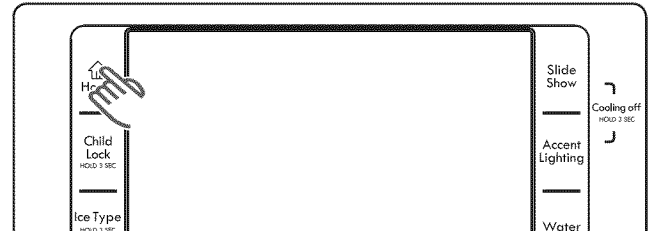

2. Choose the desired function by pressing it on the "Home" screen.

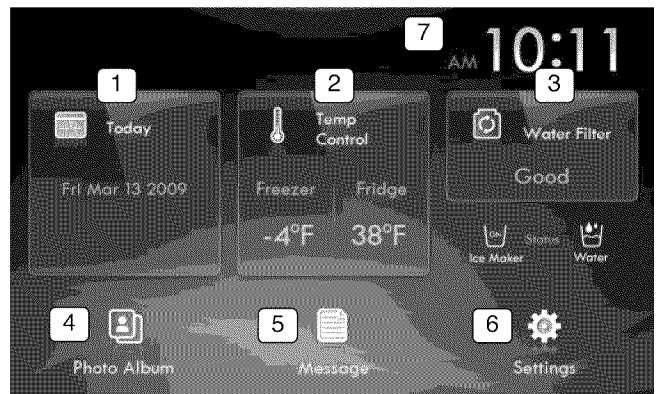

1. **Today:** You can manage your daily schedule.
2. **Temp Control:** You can set the freezer and refrigerator temperatures. (See page 27.)
3. **Water Filter:** It shows the current status of the water filter and dispenser.
4. **Photo Album:** Save favorite photos and images to make your own slide show.
5. **Message:** You can save or check necessary messages.
6. **Settings:** Allows you to set the energy saver, brightness, screen saver, volume control, touch screen correction, and current time.
7. **Task Bar:** Indicates the current time.

# USING YOUR REFRIGERATOR

## Using Slide Show

When Slide Show is selected, it shows the slides that are saved in an electronic photo album. See page 33 for instructions on setting up a slide show. If slides are not selected from the photo album, the screen will show a Kenmore Elite™ default slide.

1. Press the Slide Show button.

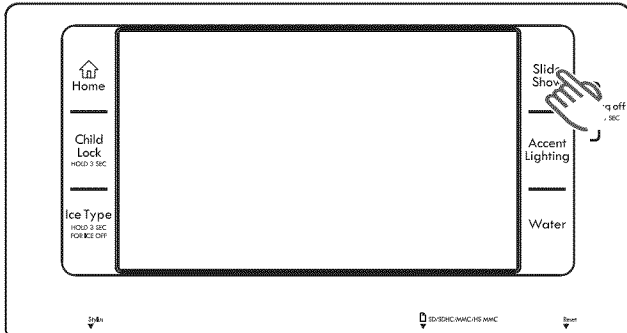

**NOTE:** The sliding photos option can be selected at “Photo Album.”

2. Press the Exit button to stop the slide show and return to the “Home” screen.



- Based on the photo size, there could be black background around the photo.
- The photo is automatically optimized for a 16:9 wide-screen format.

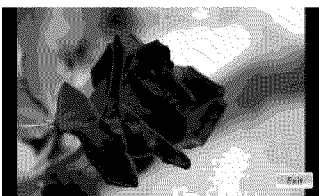

**NOTE:** Saved images can be stretched out or reversed. To use a reversed image, download it to your PC, flip the image horizontally, and then save it before uploading it to the photo album.

## Using the Child Lock Function

Activate the child lock function by pressing and holding the Child Lock button for more than 3 seconds. All control panel buttons, the touch-screen controls, and the dispenser will be deactivated. To reactivate the control buttons, the touch-screen controls, and the dispenser, press and hold the Child Lock button for more than 3 seconds.

1. Press and hold the Child Lock button for more than 3 seconds.

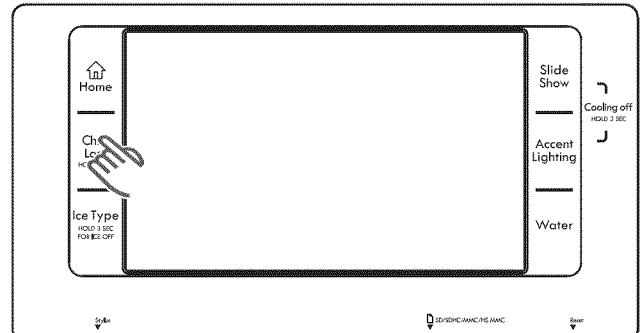

2. The “Child Lock Activated” message will be displayed and the lock icon will show up in the upper-right corner.

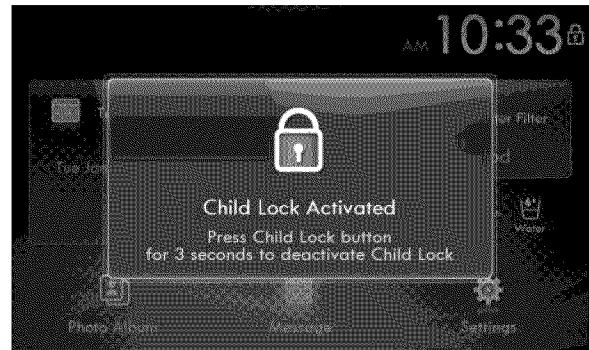

3. Press and hold the Child Lock button for more than 3 seconds to deactivate the child lock function and reactivate all operating controls. The “Child Lock Deactivated” message will be displayed and the lock icon will disappear.

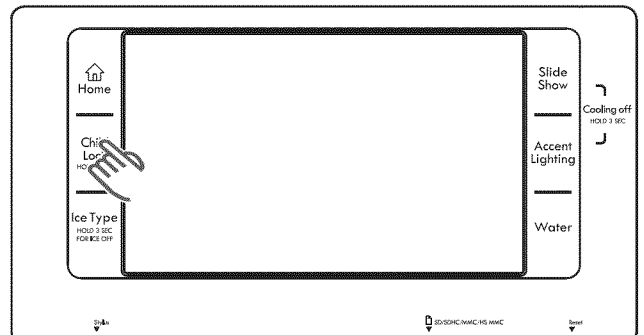

# USING YOUR REFRIGERATOR

## Dispenser Controls

The last three buttons on the control panel control the dispenser functions. These buttons include Accent Lighting around the dispenser (1), Ice Type/Ice Off (2), and Water dispensing (3).

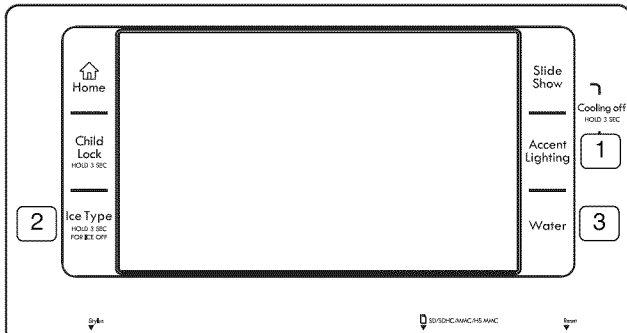

## Using the Dispenser Lighting

Dispenser lighting turns ON whenever the dispenser is operating. Five seconds after the dispenser stops dispensing, the lighting turns OFF.

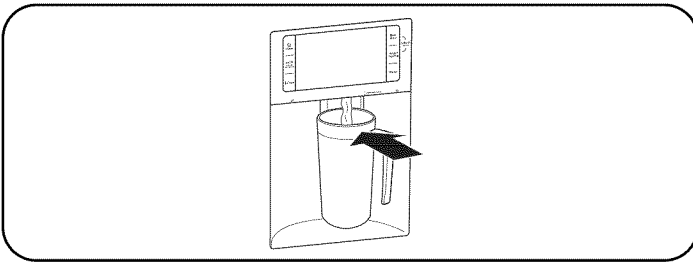

## Using the Dispenser Accent Lighting

1. Press the Accent Lighting button to have the accent lamp stay on.

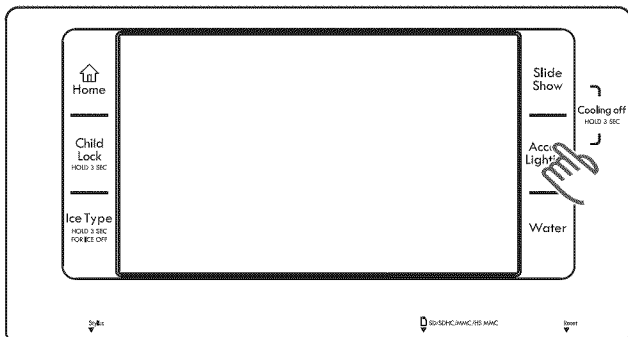

### NOTES:

- Light OFF is the default mode. The accent lamp stays off.
  - Light ON allows the accent lamp to stay on.
  - The accent lamp turns off whenever the dispenser is operating. Five seconds after the dispenser stops dispensing, the accent lamp turns back on.
2. Press the Accent Lighting button a second time to turn off the accent lamp.

## Turning Off the Ice Dispenser

The Ice Type/Ice Off button controls two functions. The length of time the control is held determines which function it controls.

1. Press and hold the Ice Type/Ice Off button for more than 3 seconds to turn OFF the icemaker. "Ice Maker Off" will show on the display.

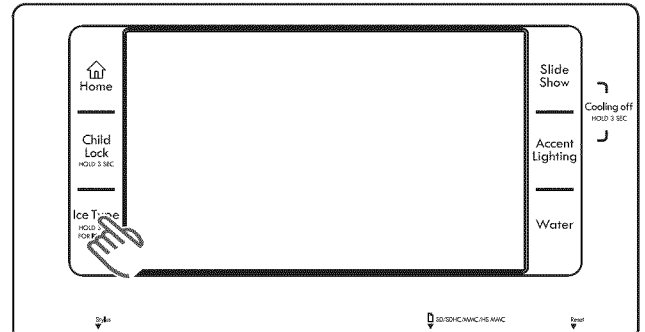

**NOTE:** Pressing the Ice Type/Ice Off button for less than 3 seconds will toggle the type of ice being dispensed.

2. Press the Ice Type/Ice Off button for more than 3 seconds to restart ice production.

## Selecting and Dispensing Ice

1. Press the Ice Type/Ice Off button for less than 3 seconds. The screen will show "Dispenser Active Cubed" or "Dispenser Active Crushed." Pressing the Ice Type/Ice Off button for less than 3 seconds again will toggle between the selections.

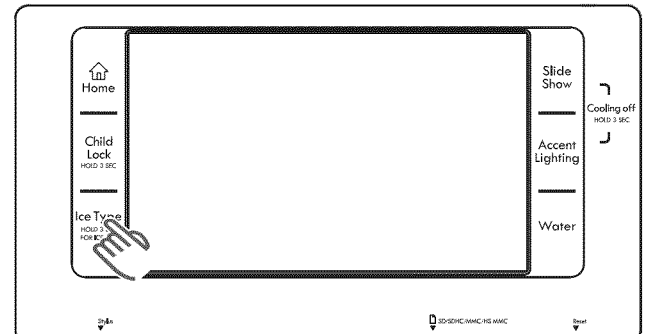

2. Place glass in dispenser to dispense selected ice.

### NOTES:

- The dispenser always defaults to the last setting that was used (Ice or Water).
- The selected dispenser function will be displayed as the ice is being dispensed.

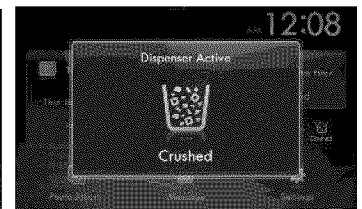
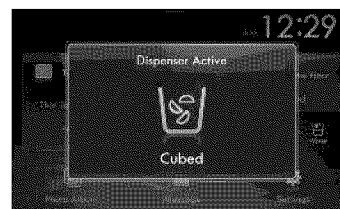

# USING YOUR REFRIGERATOR

## Selecting and Dispensing Water

1. Press the Water button. The screen will show “Dispenser Active Water.”

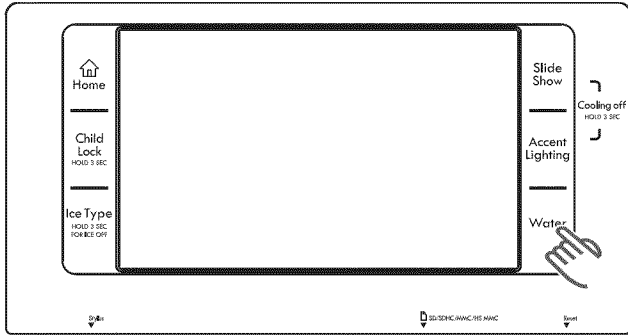

2. Place glass in dispenser to dispense refrigerated water.

### NOTES:

- The dispenser always defaults to the last setting that was used (Water or Ice).
- The dispenser function will be displayed as the refrigerated water is being dispensed.

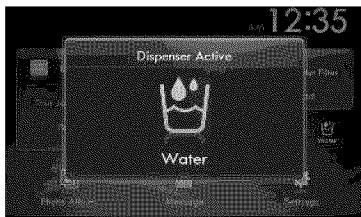

## Cooling Off (Demo Mode)

The cooling off function shuts off the cooling to the refrigerator and freezer compartments, but does not shut off the electrical power to the refrigerator. This is only used to demo refrigerator models on showroom floors.

1. Press and hold the Slide Show and the Accent Lighting buttons simultaneously for 3 or more seconds. The screen will show “Cooling OFF Setup Complete” and the refrigerator compressor functions will be deactivated.

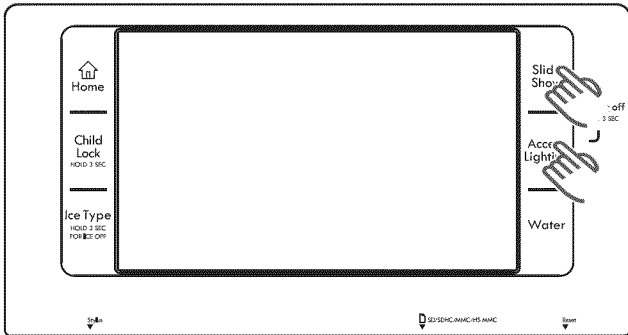

2. Press and hold the Slide Show and the Accent Lighting buttons simultaneously again for 3 or more seconds to reactivate the refrigerator compressor functions. The screen will show “Cooling OFF Deactivated.”

## Door Open Alarm

When the door is left open for more than 2 minutes, the door open alarm goes off and the display shows “Door Open.” The pop-up will disappear when the door is closed properly. The alarm will beep for about 10 seconds; then it will keep beeping every minute until the door is closed.

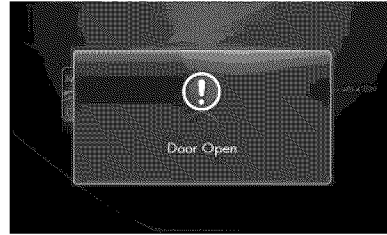

## Calendar

The calendar is designed to interact with you and your schedule. Besides telling you what day it is, the calendar can also show you special days like holidays and birthdays and display calendar memos to post instructions for others to view or use. You will never forget or miss another important function.

### How to Enter a Calendar Memo

1. Press the Home button. The display screen will show the “Home” screen.

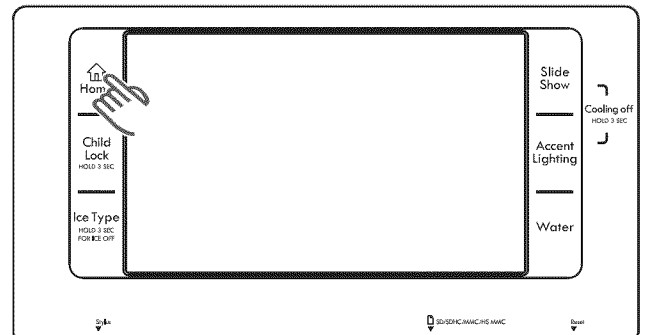

2. Press the Today button on the touch screen. The screen will show the “Calendar” screen.

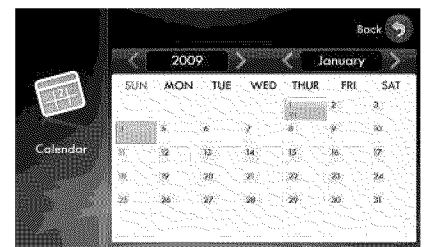
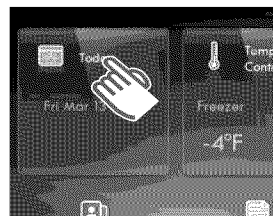

## USING YOUR REFRIGERATOR

- Choose the desired date to input a calendar memo. A blank memo pad will show on the screen for that day.

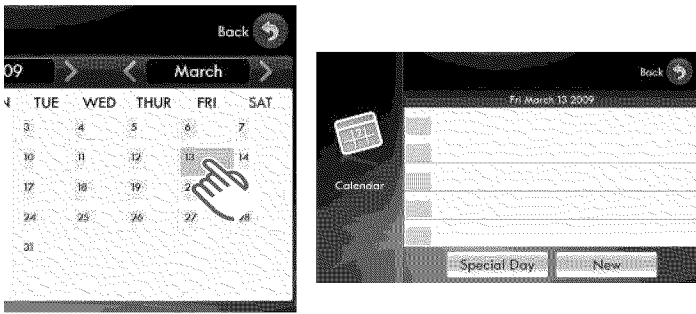

### NOTES:

- Today is highlighted in blue.
  - Special days are highlighted in green.
  - Calendar memos are highlighted in orange.
  - Up to 5 memos can be saved in a day.
- Press the New button. A keyboard will be displayed on the screen.

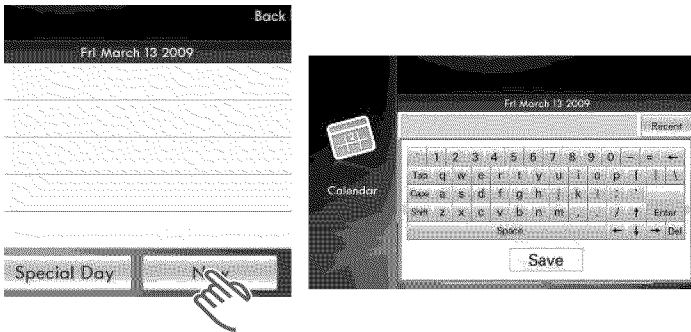

- Using the screen keyboard, type the contents of your memo. Save the memo by touching the Save button or Enter key.

**NOTE:** To view the content of recently entered memos, touch the Recent key.

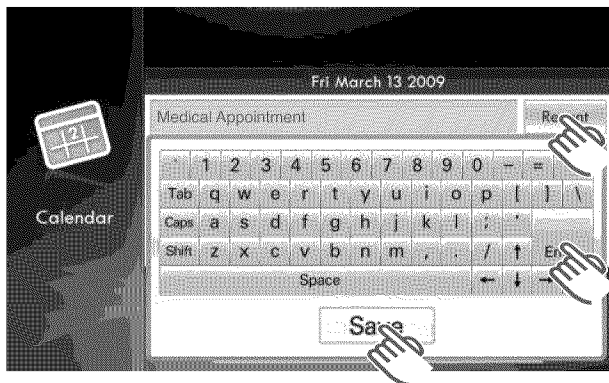

- If you want to repeat your memo within the calendar system, touch the Repeat button on the screen. This enables you to choose the repetition period (daily/weekly/monthly/yearly).

**NOTE:** The yearly button maintains and repeats the information for 10 years. All other selections maintain and repeat the information for one year.



- To set an alarm time, press the set time button on the screen. Using the < and > buttons, set the time in hours and minutes when you would like the alarm to sound. The alarm is to let you know there is a memo. Touch the OK button to enter the time.



- Touch the Save button to enter the information into the calendar.

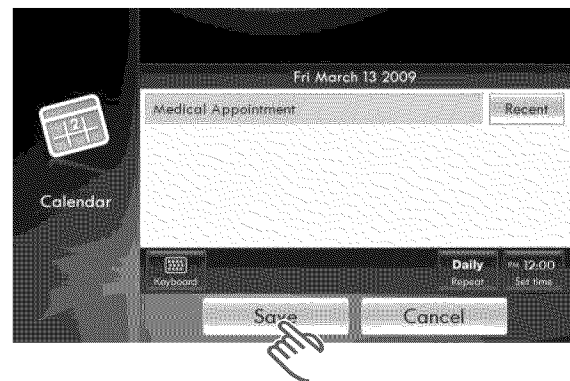

# USING YOUR REFRIGERATOR

## How to Enter a New Special Day

1. Press the Home button. The display screen will show the "Home" screen.

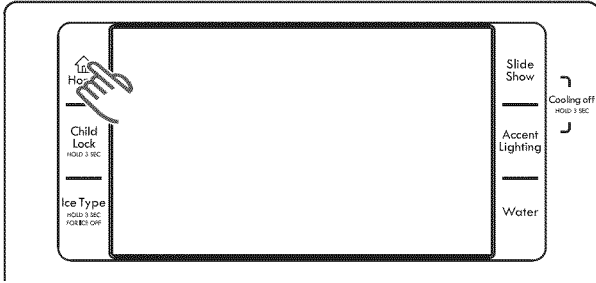

2. Touch the Today button on the touch screen. The screen will show the "Calendar" screen.

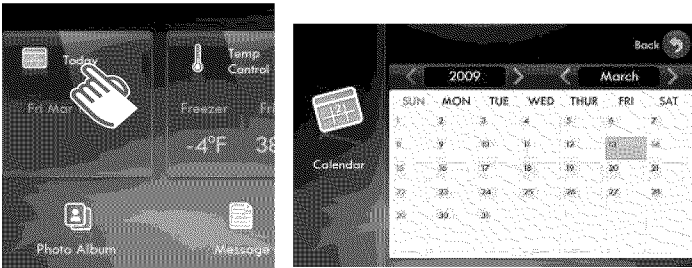

3. Choose the desired date to input a special day memo. A memo pad will show on the screen for that day.

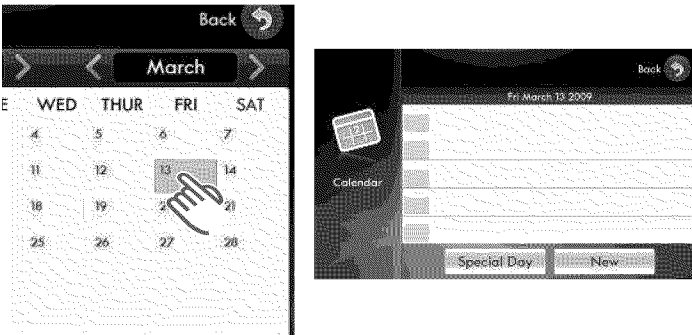

### NOTES:

- Today is highlighted in blue.
- Special days are highlighted in green.
- Calendar memos are highlighted in orange.
- Up to 5 memos can be saved in a day.

4. Touch the Special Day button. A list of special days will be displayed on the screen.

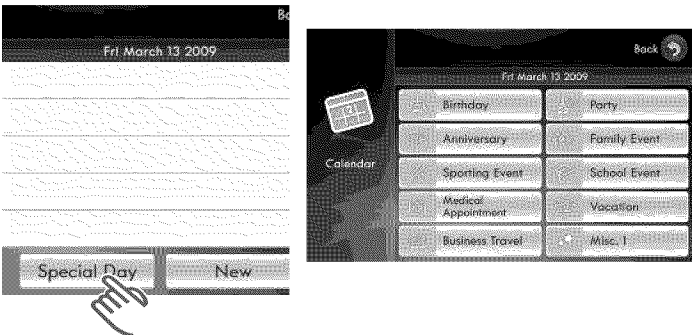

5. Touch the screen button for the special day you want to use. A keyboard will be displayed on the screen.

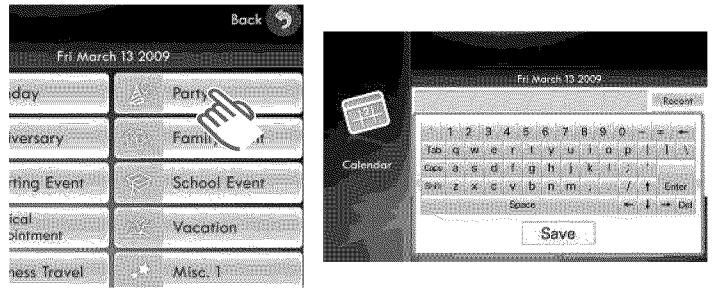

6. Using the screen keyboard, type the contents of your special day memo. Save the memo by touching the Save button or Enter key.

**NOTE:** To view the content of recently entered memos, touch the Recent key.

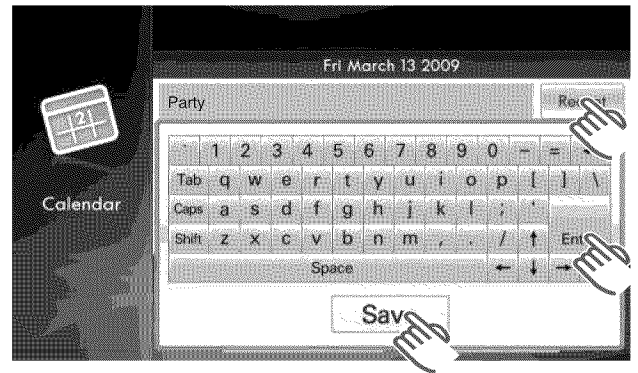

7. If you want to repeat your special day memo within the calendar system, touch the Repeat button on the screen. This enables you to choose the repetition period (daily/weekly/monthly/yearly).

**NOTE:** The yearly button maintains and repeats the information for 10 years. All other selections maintain and repeat the information for one year.

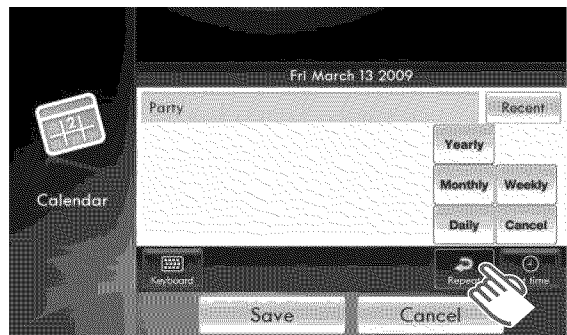

# USING YOUR REFRIGERATOR

- To set an alarm time, touch the set time button on the screen. Using the < and > buttons, set the time in hours and minutes when you would like the alarm to sound. Touch the OK button to enter the alarm time.

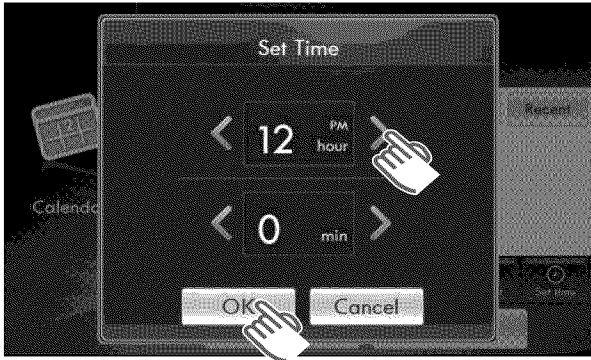

- Touch the Save button to enter the information into the calendar.

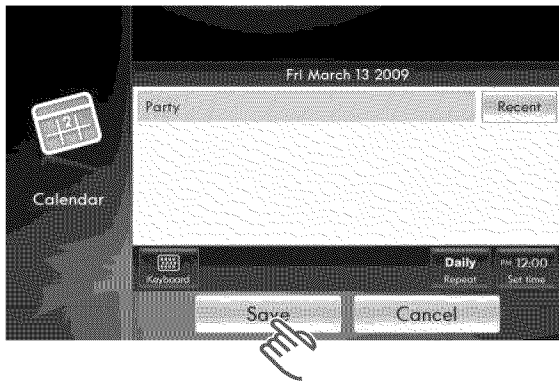

## How to Change a Calendar Memo or Special Day

- Press the Home button. The display screen will show the "Home" screen.

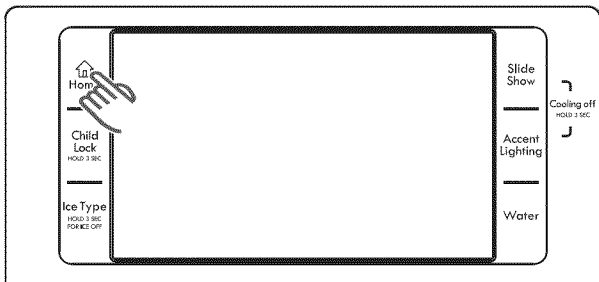

- Touch the Today button on the touch screen. The screen will show the "Calendar" screen.

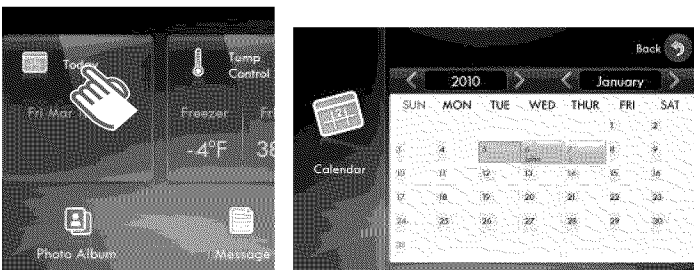

- Choose the desired date to change a calendar memo or special day. The memos for that day will appear on the screen.

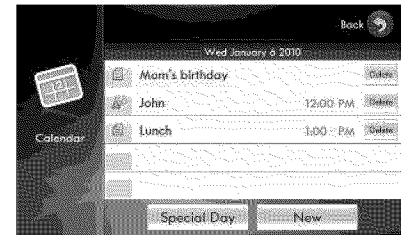
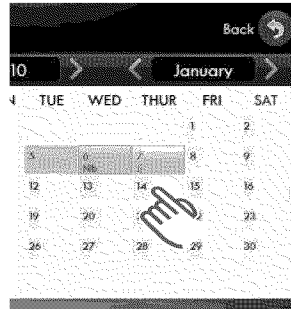

- Touch the listing for the memo or special day you want to change. The present message will be shown on the screen.

**NOTE:** If an alarm time is set, the alarm time will be shown at the end of the memo or special day.

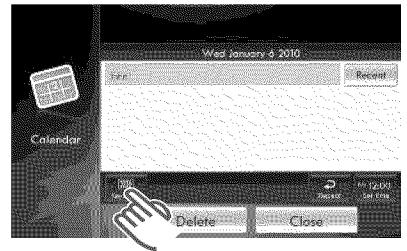

- Touch the keyboard button on the screen. The screen will show a screen keyboard. Using the screen keyboard, change the memo or special day message. Save the new memo or special day by touching the Save button or Enter key.

**NOTE:** To view the content of recently entered memos, touch the Recent key.

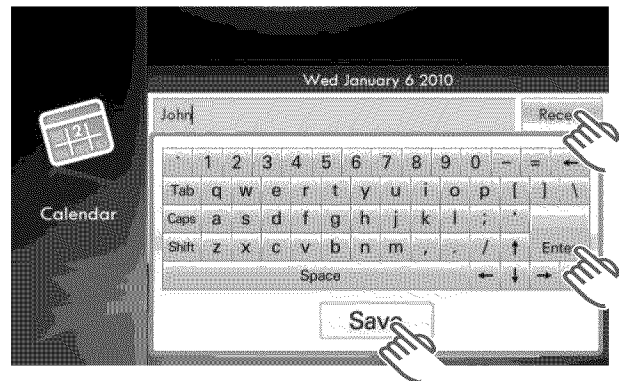

# USING YOUR REFRIGERATOR

- If you want to change or select a repeat for your memo or special day, touch the Repeat button on the screen. This enables you to choose the repetition period (daily/weekly/monthly/yearly).

**NOTE:** The yearly button maintains and repeats the information for 10 years. All other selections maintain and repeat the information for one year.

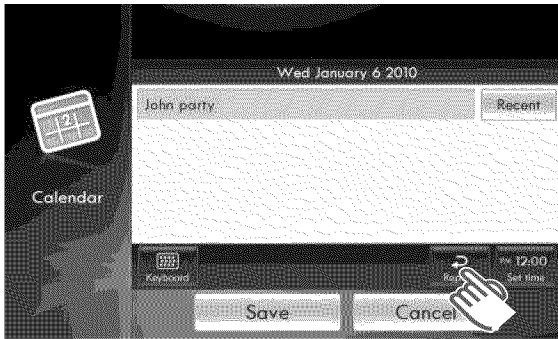

- To change or set an alarm time, touch the Set Time button on the screen and use the < and > buttons to set the time in hours and minutes. Touch the OK button to save and set the new alarm time.

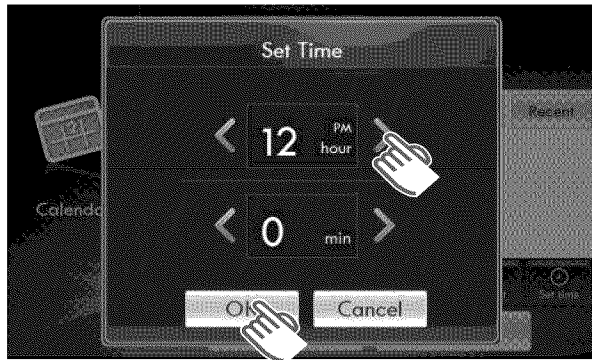

- Touch the Save button to enter the revised information into the calendar.

**NOTE:** If you modified the contents in steps 5–7, the Delete and Close buttons will replace the Save and Cancel buttons.

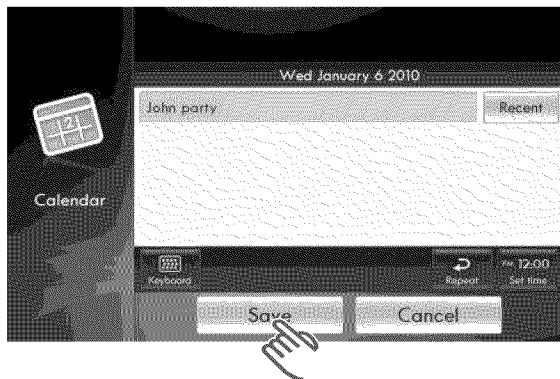

## How to Delete a Calendar Memo or Special Day

- Press the Home button. The display screen will show the “Home” screen.

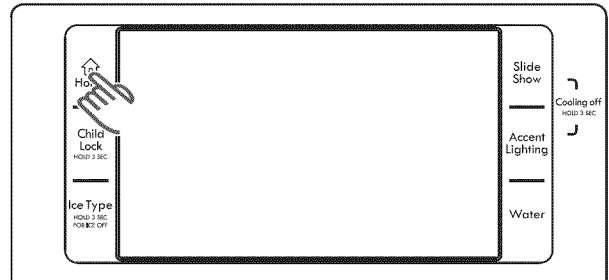

- Touch the Today button on the touch screen. The screen will show the “Calendar” screen.

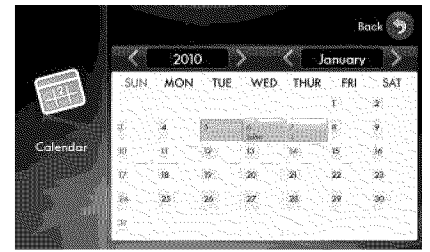
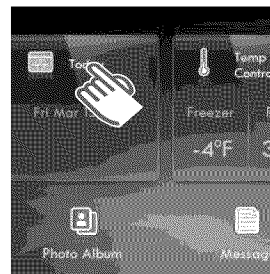

- Choose the desired date to delete a calendar memo or special day. The memos for that day will appear on the screen.

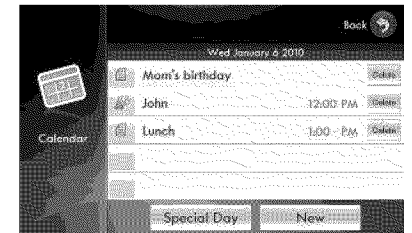
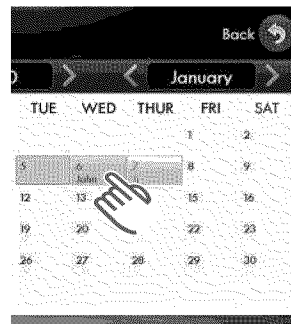

- Touch the Delete button at the end of the memo or special day you want to delete. A “Delete Memo?” screen will be displayed.

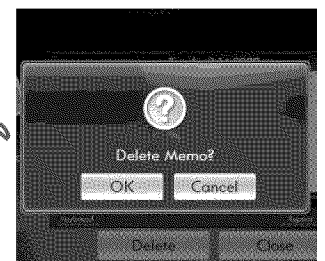
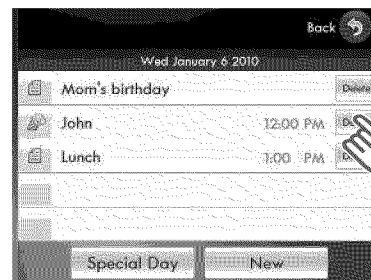

## USING YOUR REFRIGERATOR

5. Touch the OK button to complete deleting the memo or special day.

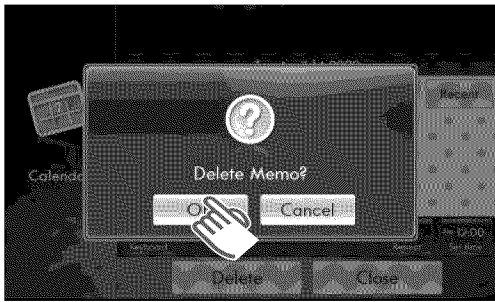

## Calendar Memo Alarm

The calendar alarm is designed to remind you there is a calendar memo or special day event for that day. At the scheduled time, the calendar alarm will sound and the “Check Calendar Memo” screen will appear on the screen.

1. Touch the OK button on the screen to view the calendar memo or special day event. The memo for that day will appear on the screen.

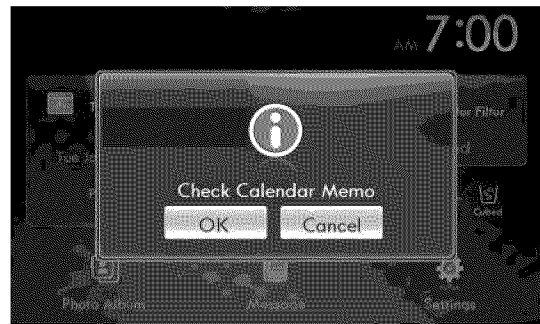

2. Touch the memo or special day you want to check. The selected memo or special day will appear on the screen.

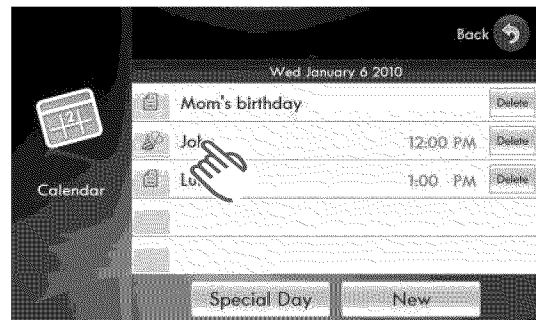

# USING YOUR REFRIGERATOR

## Temp Control

The temperature control allows you to set the freezer and the refrigerator temperatures. Use the following instructions to change and set these temperatures.

1. Press the Home button. The display screen will show the "Home" screen.

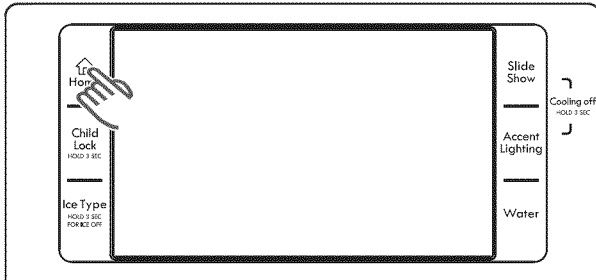

2. Touch the Temp Control button on the touch screen.

**NOTE:** When ice cream is stored at a temperature above 4°F (-16°C) in the freezer, it may melt.

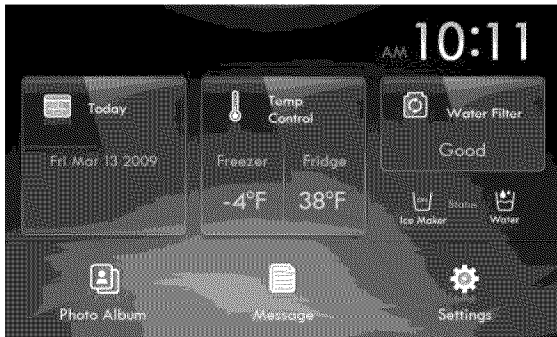

3. Choose the desired freezer and/or refrigerator temperatures using the < and > buttons to the left and right of the currently set temperatures.

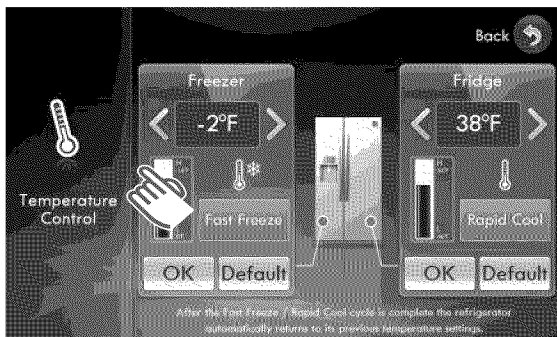

**NOTE:** The freezer temperature can be set between 8°F (-13°C) and -14°F (-26°C). The refrigerator temperature can be set between 46°F (8°C) and 34°F (1°C). The default freezer and refrigerator temperatures are -2°F (-19°C) and 38°F (3°C) respectively.

4. Touch the OK button(s) under the new temperature(s) to set and save the setting(s).

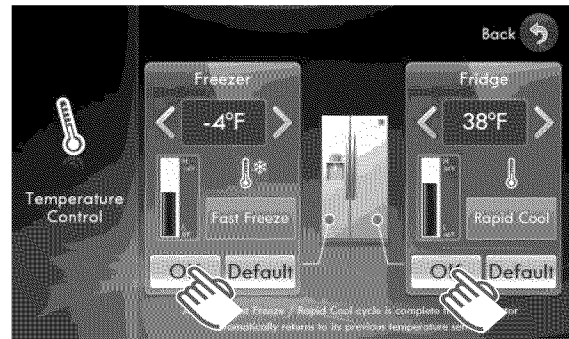

### NOTES:

- The freezer or refrigerator temperature may change depending on the door opening/closing frequencies, the food quantity, the ambient temperature, etc.
- Temperatures vary at each food storage section in the freezer and refrigerator compartments.
- When power comes back after a short outage and the refrigerator temperature is lower than 42°F (6°C), the refrigerator and freezer will adjust to the last temperatures that were set. If the refrigerator temperature is higher than 42°F (6°C), it will revert back to the default temperatures of 38°F (3°C) and -2°F (-19°C) respectively.
- Changing a temperature setting requires 3–4 hours for the stored food to reach the new temperature setting.
- See page 28 for important icemaker operating information.

## USING YOUR REFRIGERATOR

### About the Automatic Icemaker

Ice is made in the automatic icemaker and sent to the dispenser. The automatic icemaker is designed to make ice cubes 24-hours per day. The quantity will vary depending on the freezer compartment temperature, room temperature, number of door openings, freezer load, and other operating conditions.

- Ice takes about 12 to 24 hours for a newly installed refrigerator to make ice.
- Icemaking stops when the ice bucket is full.
- To turn off the automatic icemaker, press the Ice Off button on the digital panel on the front of the left refrigerator door.
- The cube size will vary depending on the water pressure of the connected water line.

**NOTE:** It is normal that a noise is produced when the ice drops into the ice bucket.

- Even when the water pipe is not connected and the icemaker is turned on, the water valve operates. The noise is generated because the water pipe is not connected, which does not mean the icemaker is defective.

### ⚠ WARNING

#### Personal Injury Hazard

Avoid contact with the moving parts of the ejector mechanism and/or with the heating element that releases the cubes. **DO NOT** place fingers or hands on the automatic icemaker mechanism while the refrigerator is plugged in.

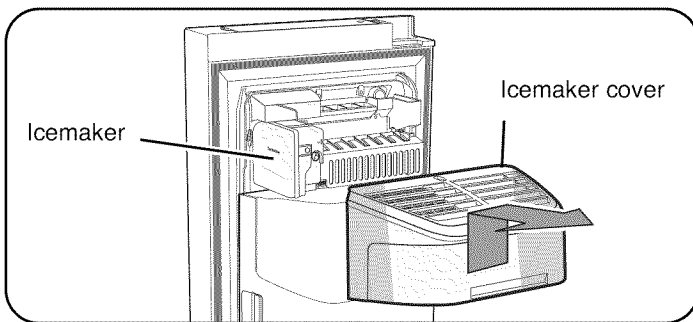

### ⚠ CAUTIONS

- The first ice and water may include particles or odor from the water supply line or the water tank.
- Throw away the first few batches of ice and purge the dispenser for 2 minutes after a refrigerator installation or if the refrigerator has not been used for a long period.
- Keep children away from the dispenser. Children may damage the controls.

### ⚠ CAUTIONS (cont.)

- Never store beverage cans or other foods in the ice bucket for the purpose of rapid cooling. Doing so may damage the icemaker or the containers may burst.
- If discolored ice is dispensed, check the water filter and water supply. If the problem continues, contact an authorized service center. Do not use the ice or water until the problem is corrected.
- If you only dispense crushed ice, the ice passage could become blocked with frost. Remove the frost that accumulates.
- Never use crystal glass or crockery to collect ice. Such glasses or containers may break, and glass fragments could be in the ice.
- Dispense ice into a glass before filling with liquid to avoid splashing.
- Never use a glass that is exceptionally narrow or deep. Ice may jam in the ice passage and the refrigerator performance may be affected.
- Keep the glass at a proper distance from the ice outlet to ensure proper ice dispensing.
- To avoid personal injury, keep hands out of the ice door and passage.

#### When Should the Icemaker Be Turned Off?

- When the water supply will be shut off for several hours.
- When the ice bucket is removed for more than a minute or two.
- When the refrigerator will not be used for several days.

**NOTE:** Ice bucket should be emptied anytime the icemaker is turned off.

#### Normal Sounds You May Hear

- The icemaker water will buzz as the icemaker fills with water. If the icemaker is turned on, it will buzz even if it has not been hooked up to water. To stop the buzzing, turn off the icemaker.

**NOTE:** Icemaker bucket should be emptied anytime the icemaker is turned off.

**NOTE:** Turning on the icemaker before the water line is connected can damage the icemaker.

- You will hear the sound of cubes dropping into the ice bucket and water running in the pipes as the icemaker refills.

# USING YOUR REFRIGERATOR

## Setting Fast Freeze or Rapid Cool

The Fast Freeze and Rapid Cool functions can be used to quickly lower the temperature of the freezer and refrigerator compartments. These buttons are found on the "Temp Control" touch screen. Use the following instructions to activate these functions.

1. Press the Home button. The display screen will show the "Home" screen.

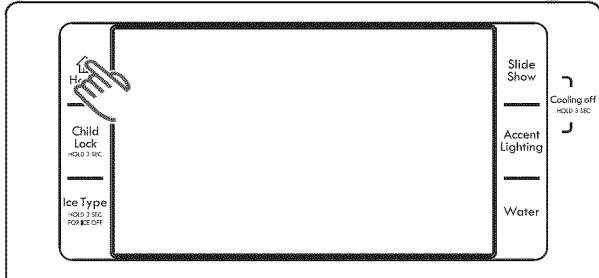

2. Touch the Temp Control button on the touch screen.

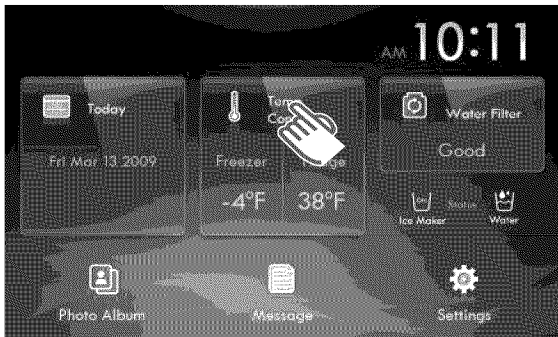

3. Touch the Fast Freeze and/or Rapid Cool button(s); then touch the OK button(s) under the selected button(s).

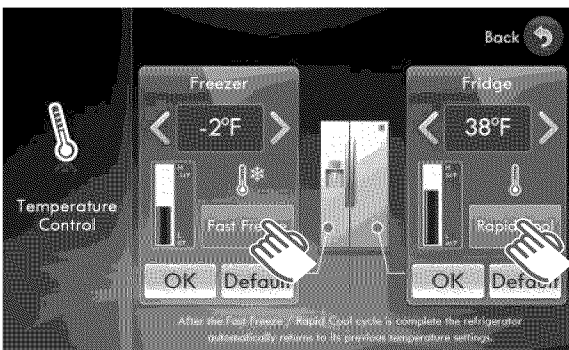

### NOTES:

- While the Fast Freeze and/or Rapid Cool is activated, the temperature setting buttons are deactivated.
- When Fast Freeze and/or Rapid Cool functions are finished, the temperature settings are reactivated so they can be changed.
- Energy consumption increases during Fast Freeze and/or Rapid Cool usage.

## Water Filter

The Water Filter button on the "Home" touch screen enables you to check the current status of the water filter. Use the following instructions to check and/or replace the water filter.

1. Press the Home button. The display screen will show the "Home" screen.

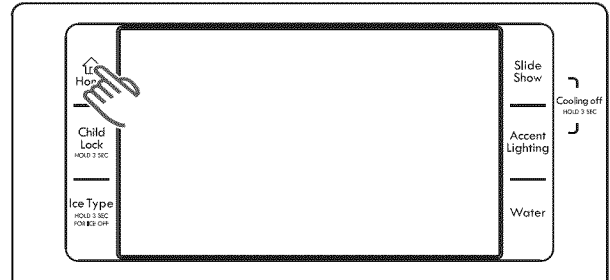

2. Touch the Water Filter button on the touch screen. One of the following water filter status screens will be displayed.

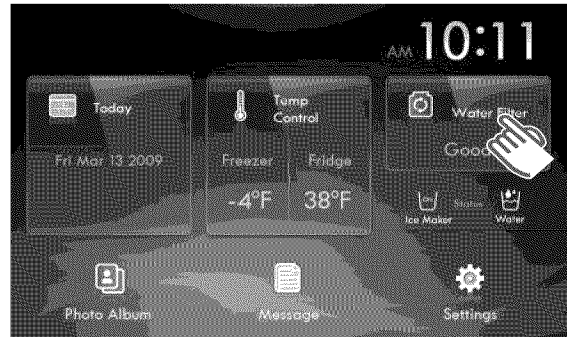

The filter does not need replacement. It is normal:

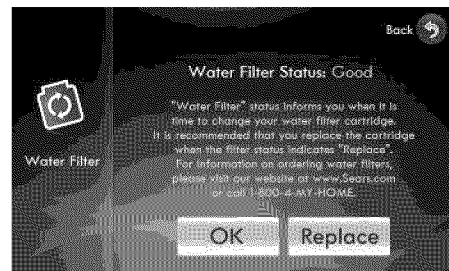

The filter needs replacement:

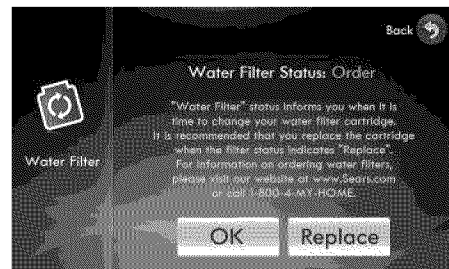

# USING YOUR REFRIGERATOR

The filter needs replacement immediately:

## Replace

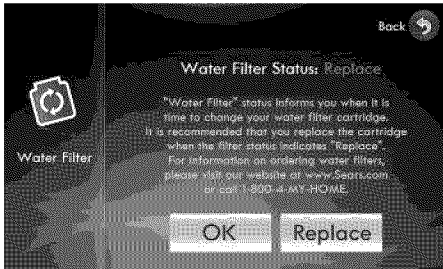

3. If the status reads "Order" or "Replace," touch the Replace button on the bottom of the screen to access the replacement instructions.

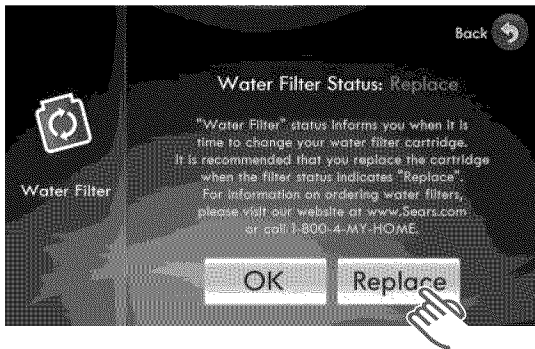

Touching the Next button at the bottom of the screen will continue the instructions.

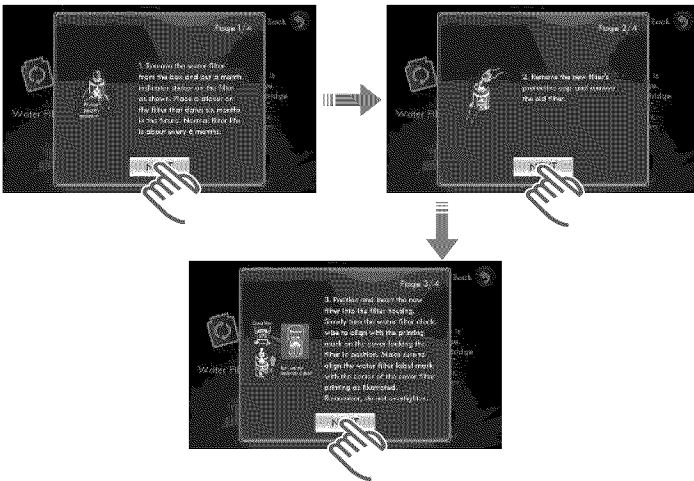

**NOTE:** Refer to the water filter replacement guide and replace the water filter at the right-upper corner of the refrigerator. (See pages 13 and 14.)

4. When the replacement is done, touch the OK button at the bottom of the screen. The display screen will show the "Home" screen.

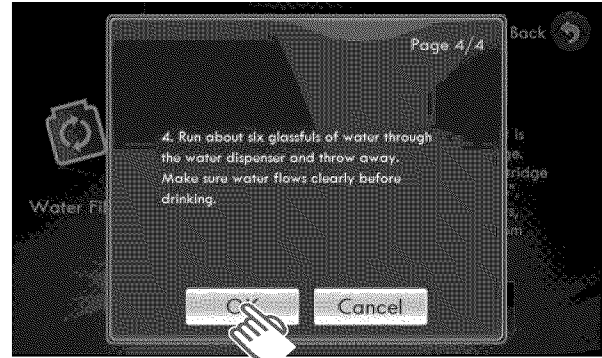

## CAUTION

DO NOT use the water or ice dispenser without a water filter cartridge because the water line may become blocked or damage the dispenser.

**NOTE:** Be sure to flush the dispenser thoroughly to avoid possible water dripping from the dispenser. This means that there is still air in the line.

5. Filter replacement is done.

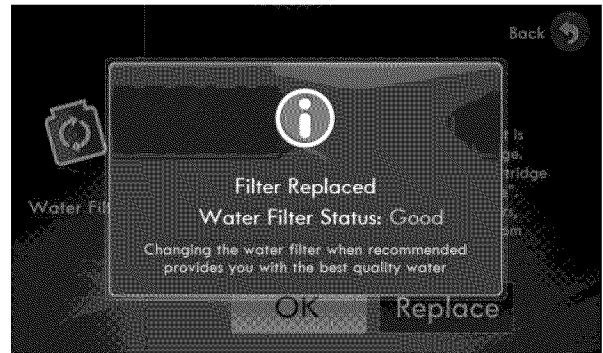

## Ordering Replacement Water Filter

To purchase replacement water filter cartridges, call 1-800-4-MY-HOME®.

## Photo Album

Save photos you shot yourself or images you want and make your own slide show. When the memory card is inserted, the photo album is automatically run.

### Uploading Images

1. Pull out the cover over the card slot and move it to the side.
2. Insert the memory card (SD/SDHC/MMC/HS MMC) with images saved into the card slot.
  - The photo album automatically runs after the “Memory Card Connected” message appears.
  - If there are no images saved on the memory card, the photo album will not run.

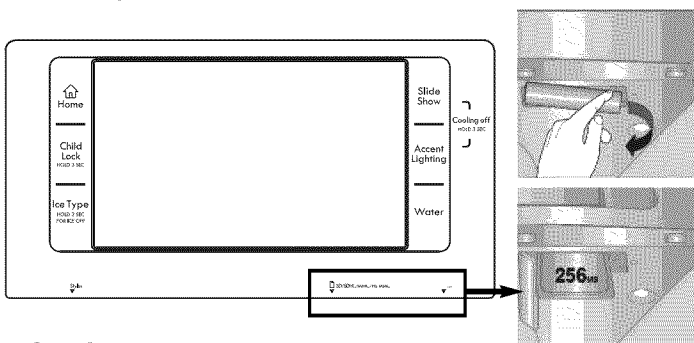

#### NOTES:

- The card slot is only for SD/SDHC/MMC/HS MMC-type memory cards.
- It reads only JPEG images.
- It can save up to 10 megapixel JPEG images (3,872 x 2,592 pixels, 24 bit). (When images are more than 10 megapixels or their definitions are changed, the images will not display on the screen.)
- If there are many photos saved on the memory card, it will take awhile for the preview function to load.
- When the memory card is removed before the image transferring is complete, the photo album shows the images that have completed transfer in the left-upper corner.
- The saved images will be displayed to fit the screen size. Depending on image sizes, these could be displayed with black bars on the top or sides.
- A memory card is not supplied with the refrigerator.
- Depending on the type of SD/SDHC/MMC/HS MMC memory cards, there could be unreadable cards. (SanDisk 1GB and Transcend MMC PLUS are recommended.)
- The memory capacity for the refrigerator panel is 128MB. This will hold a maximum of 70 photos.
- When saving photos from a memory card to the panel, the photo size is automatically changed to 800 x 480 pixels, regardless of the original size.

3. Choose the Upload pictures button. The display screen will show the “External Album : Upload Pictures” screen.
  - The Upload pictures button will load and store pictures in the screen panel memory.
  - Touch the Play slide show from external card button to use the photos on the card as a slide show.



**NOTE:** An “External Album : Play Slide Show” screen will appear to set up the slide show from the external card.

4. Select images to save in the photo album among the images saved in the memory card.
  - Multiple images can be selected.
  - It shows the possible number of images at the bottom of the image list.
  - “External Album : Upload Pictures” screen provides a preview function of up to 100 saved images in the memory card.



5. Choose the Upload Selected Images button.
  - To save all the images in the memory card to the photo album, touch the Upload All button.
  - Up to 70 photos can be saved.
  - When the Photo Album button is selected, the current images in the photo album are shown.



# USING YOUR REFRIGERATOR

- If the External Album button below the photo album images is touched, the screen will go back to the “What do you want to do?” screen.

**NOTE:** This product uses parts of the software from the independent JPEG Group.

6. The screen displays “Uploading Selected Image(s)” while the images are uploading from the memory card.

### NOTES:

- Large photo file sizes will slow down the uploading speed. Reformatting photos to their smallest file sizes before they are uploaded will ensure the fastest uploading speeds.
- High-definition or horizontal images (landscape) could be distorted.



7. After the images have been uploaded, “Are you finished uploading pictures?” will be displayed on the screen.

- Touch the OK button when there are no more images to be uploaded.
- Touch the Cancel button to upload more images. The display will go back to the “External Album : Upload Pictures” screen. Repeat steps 4–7.

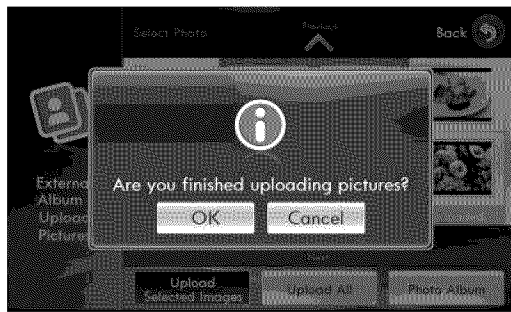

8. DO NOT remove the memory card from the slot under the display until the screen shows “Please Remove Memory Card.”
9. Replace the cover over the card slot.

## Deleting Images

1. Press the Home button. The display screen will show the “Home” screen.

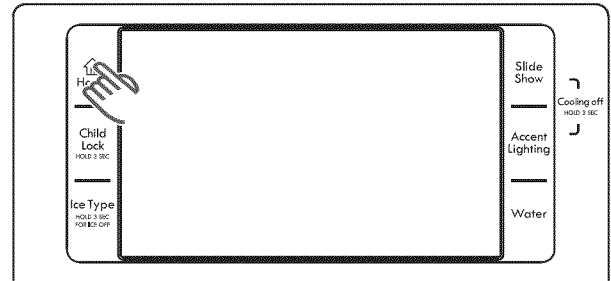

2. Touch the Photo Album button in the left bottom corner of the touch screen. The images in the photo album will appear on the screen.



3. Select the images you want to have deleted; then touch the Delete Selected button. “Delete Selected Image(s)?” will appear on the screen.

### NOTES:

- Multiple images can be selected and deleted.
- The Kenmore Elite™ default slide cannot be deleted.

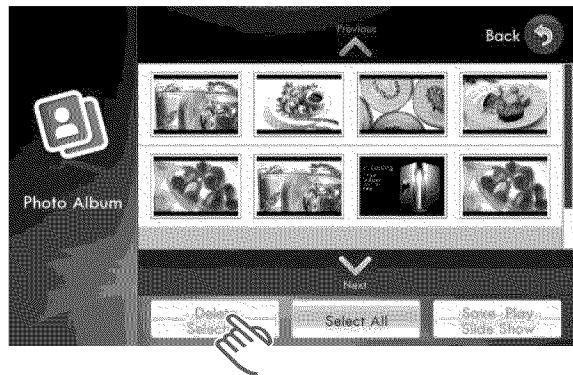

4. Touch the OK button to complete the deletion process.

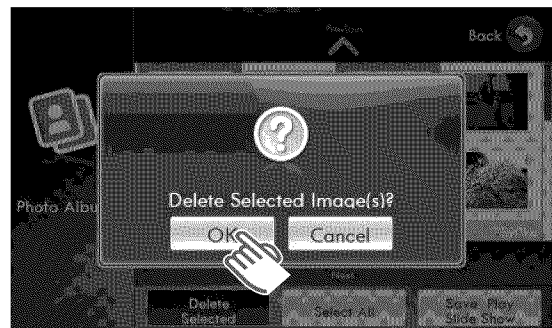

# USING YOUR REFRIGERATOR

## Setting Up a Slide Show From the Photo Album

1. Press the Home button. The display screen will show the "Home" screen.
2. Touch the Photo Album button on the touch screen. The images in the photo album will appear on the screen.

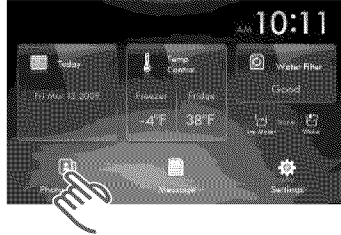
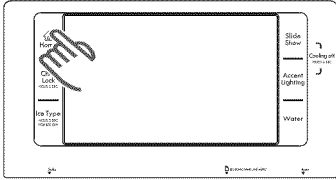

3. Select images to be used in the Slide Show; then touch the Save Play Slide Show button. The slide show will preview the selected slides.
  - Multiple images can be selected.
  - Depending on the photo size (width and height), there could be black bars on the top/bottom and/or sides of the image.
  - The screen is optimized for 16:9 image size (horizontal format).
  - When only the original default image is in the photo album, it will automatically show in the slide show.

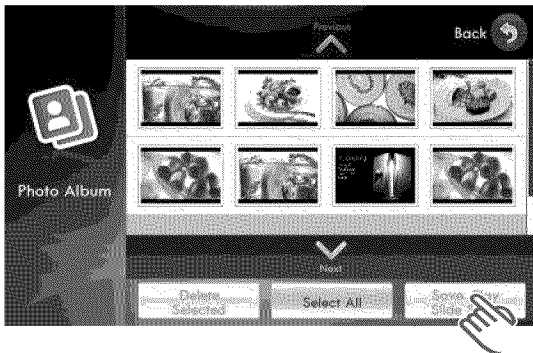

4. Touch the OK button to save the slide show as it is. Touch the Cancel button and repeat Step 3 to add more slides.



5. To view the slide show, press the Slide Show button on the upper right.

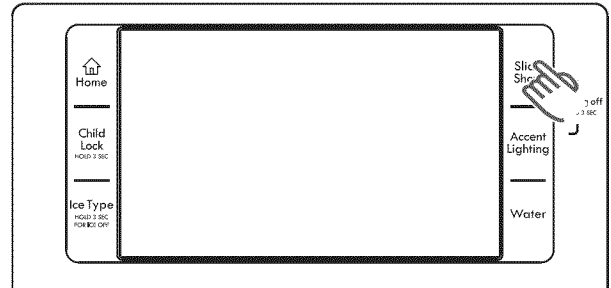

## ADDITIONAL IMAGING NOTES:

- When stationary images, same-size images, or images with black bars are displayed for extended periods of time, they can cause screen burn. Selecting and using different-sized images throughout the slide show will prevent screen burn.
- The warranty does not cover damage from screen burn.



(Image with left and right black bars)

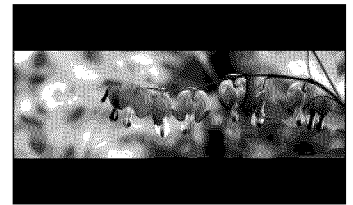

(Image with top and bottom black bars)

# USING YOUR REFRIGERATOR

## Setting Up a Slide Show from an External Card

1. Insert the memory card (SD/SDHC/MMC/HS MMC) with the saved images in the card slot at the bottom of the screen. "What do you want to do?" will be displayed on the screen.

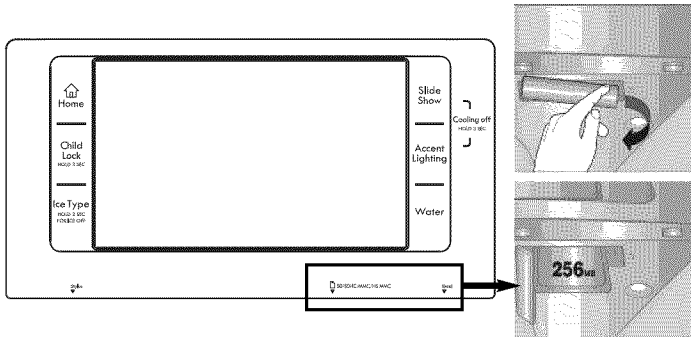

2. Touch the Play slide show from external card button on the screen. The images on the external card will be displayed on the screen.



3. Select the photos you want to be used in the slide show; then touch the Save Play Slide Show button. The slide show will preview the selected slides.
  - Multiple images can be selected.
  - Depending on the photo size (width and height), there could be black bars on the top/bottom and/or sides of the image.
  - The screen is optimized for 16:9 image size (horizontal format).
  - When the Photo Album button is selected, it goes to the current images in the photo album.
  - The "External Album : Play Slide Show" screen can preview up to 2,000 saved images from a memory card.

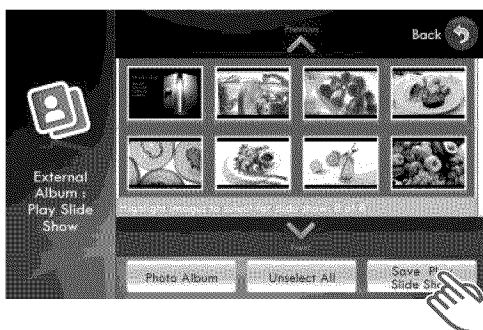

4. Touch the OK button to save the slide show as it is.

Touch the Cancel button and repeat step 3 to add more slides.

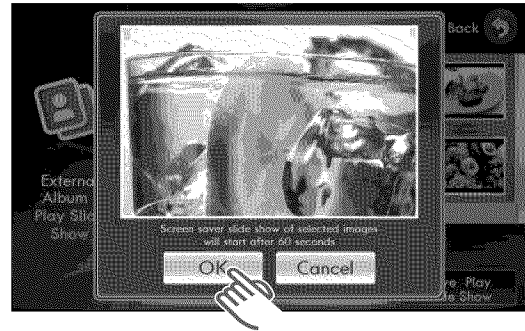

5. To view the slide show, press the Slide Show button on the upper right.

### NOTES:

- Loading can take 4–30 seconds depending on the size of the image files saved on the memory card.
- When the memory card is removed from the card slot, the slide show will go back to the previously set slide show or the default-image slide show.

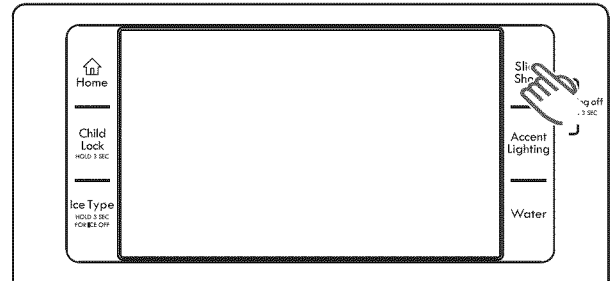

### ADDITIONAL IMAGING NOTES:

- When stationary images, same-size images, or images with black bars are displayed for extended periods of time, they can cause screen burn. Selecting and using different-sized images throughout the slide show will prevent screen burn.
- The warranty does not cover damage from screen burn.



(Image with left and right black bars)

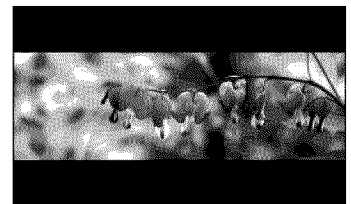

(Image with top and bottom black bars)

# USING YOUR REFRIGERATOR

## Message

The message feature allows you to leave handwritten or typed messages on the screen for yourself or someone else.

### Leaving a new message

1. Press the Home button. The display screen will show the "Home" screen.

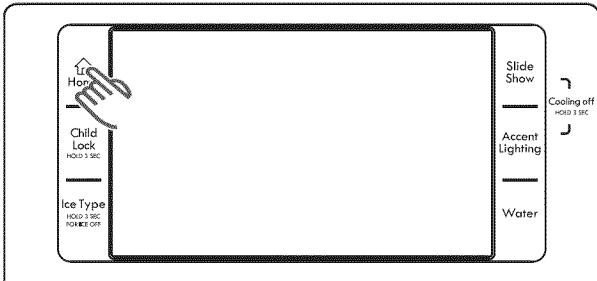

2. Touch the Message button in the center bottom of the touch screen. The "Message" screen will appear.



3. Touch the New button. A blank message screen will appear.

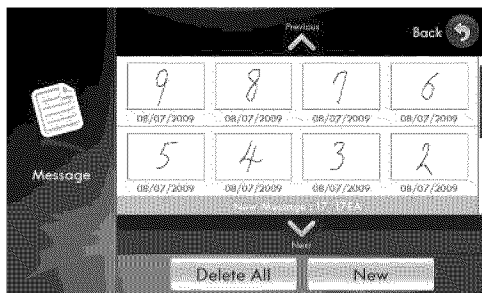
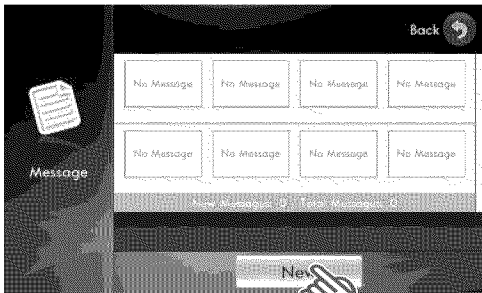

**NOTE:** The new message is highlighted.

4. Select the messaging tools as needed by touching the buttons under the message screen. Enter the message contents with the selected tools.

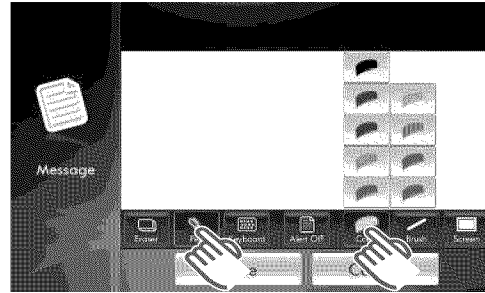

- Eraser – Select to erase any part of an inputted pen message.
- Pen – Select to input a message with the stylus.
- Keyboard – Select to input a typed message.
- Alert On/Off – Signals there is a new message on the home screen.
- Screen – Selects the background for the message.
- Brush – Selects the thickness for the stylus.
- Color – Selects the color of the stylus.
- All Eraser – Select to erase an entire pen message.

**NOTE:** When Eraser is selected, the All Eraser appears on the screen above the Color button.

5. If you want to alert someone of this new message, touch the Alert On/Off button.



6. Touch the Save button to enter and save the message information.

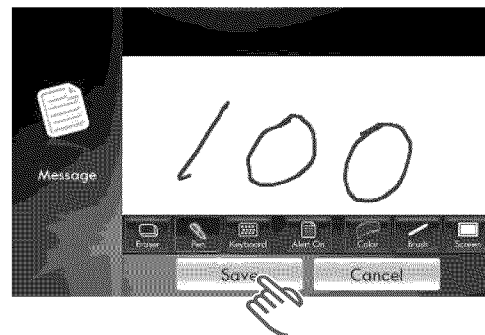

### NOTES:

- Up to 100 messages can be saved.
- If a message has been saved with an alert, the Message button on the "Home" screen will blink.

# USING YOUR REFRIGERATOR

## Changing a message

1. Press the Home button. The display screen will show the "Home" screen.

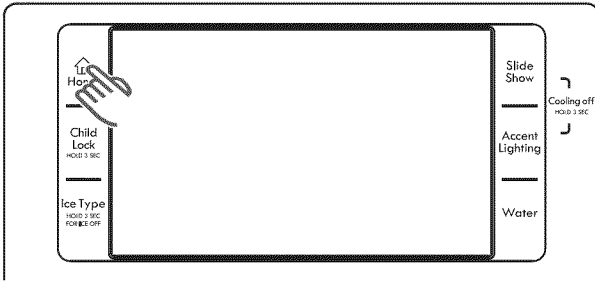

2. Touch the Message button in the center bottom of the touch screen. The "Message" screen will appear.



3. Select the message you want to change by touching it on the screen. The selected message will appear.

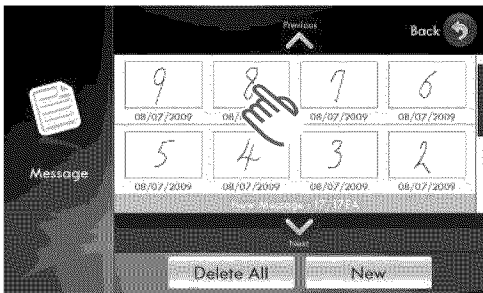

4. Select the tools to make the desired changes to the message. The message changes will appear on the screen as they are entered.

**NOTE:** When you modify the message contents, the Delete and Close buttons will be replaced with Save and Cancel buttons.

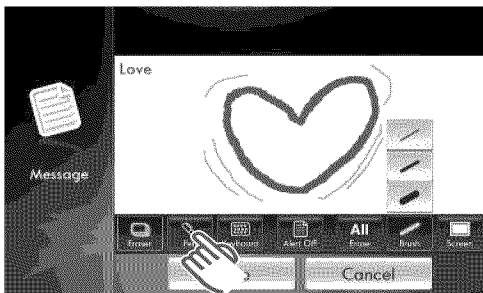

5. Touch the Save button to save and enter the changed message.

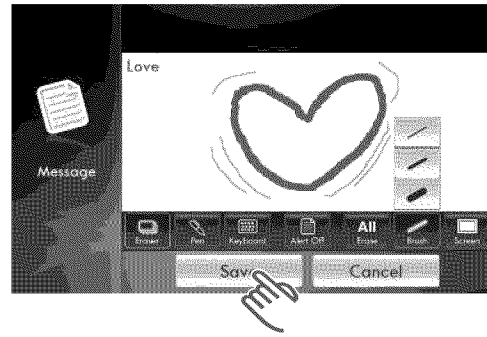

## Deleting a message

1. Press the Home button. The display screen will show the "Home" screen.

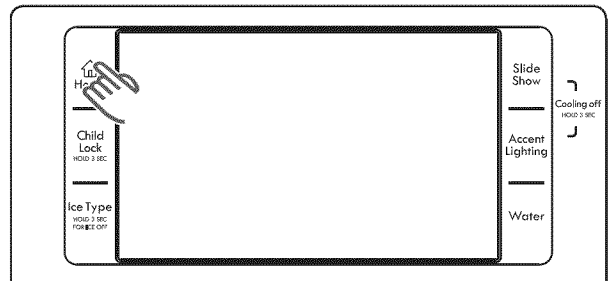

2. Touch the Message button in the center bottom of the touch screen. The "Message" screen will appear.



3. Select the message you want to delete. The selected message will appear on the screen.

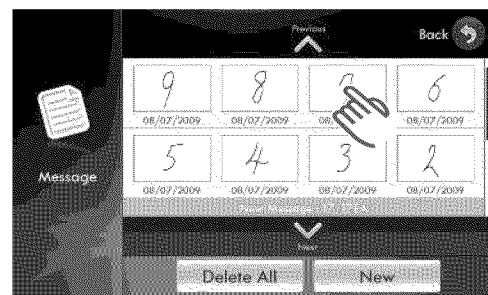

# USING YOUR REFRIGERATOR

## Deleting a message (cont.)

4. Touch the Delete button under the message screen. The “Delete Message?” screen will appear.

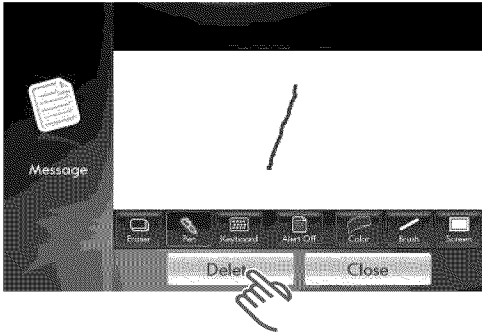

5. Touch the OK button to delete the message.

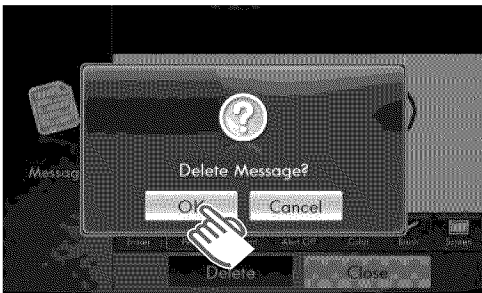

## New Message Alert

If the Alert On button is selected and saved with a message, “Check Message” appears on the screen when the LCD turns on.

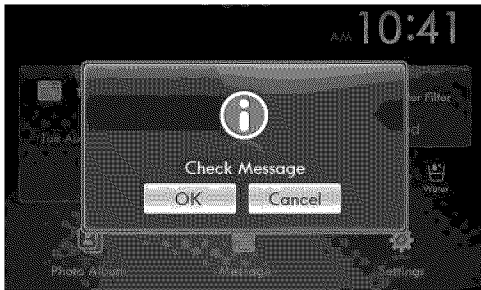

- Touch the OK button to view the new message.
- Touch the Cancel button to clear the alert.

## Settings

You can customize the following areas under the Settings button: Energy Saver, Brightness, Screen Saver, Volume Control, Touch Screen Correction, and Current Date/Time.

### How to toggle the energy saver function.

If condensation occurs on the doors, turn the energy saver function off.

1. Press the Home button. The display screen will show the “Home” screen.

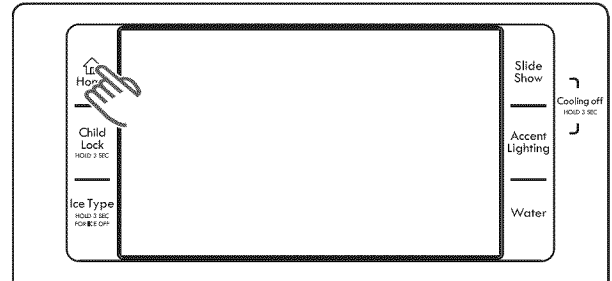

2. Touch the Settings button in the lower-right corner of the touch screen. The “Settings” selection screen will be displayed.

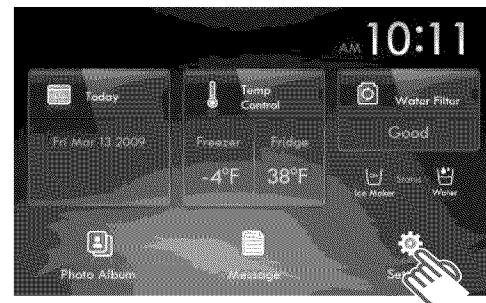

3. Touch the Energy Saver On button to deactivate the energy saver feature. “Energy Saver Deactivated” will appear on the screen.

**NOTE:** “Energy Saver On” is the default setting.

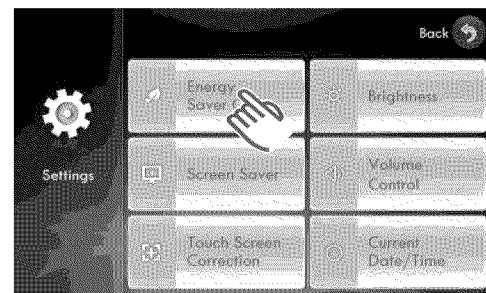

# USING YOUR REFRIGERATOR

- After “Energy Saver Deactivated” is displayed on the screen, the settings screen will display the Energy Saver Off button, indicating the energy saver function is OFF.

**NOTE:** The Energy Saver button shows the current set condition.

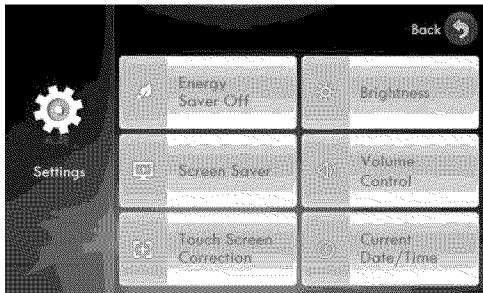
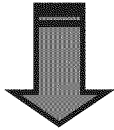
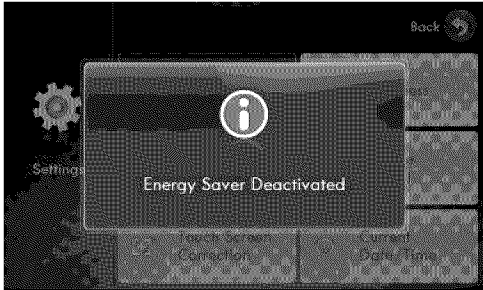

- Touch the Brightness button in the upper-right corner of the touch screen. The brightness control will appear on the screen.

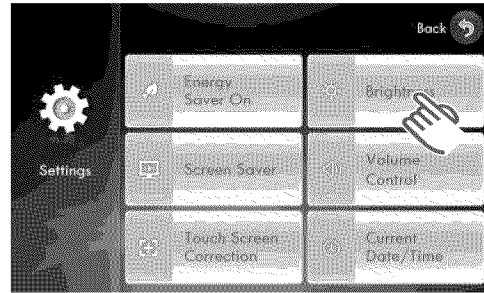

- Adjust the screen brightness by touching the Dark and Bright < and > buttons on the touch screen.
  - Each time an arrow is touched, the screen brightness will change.

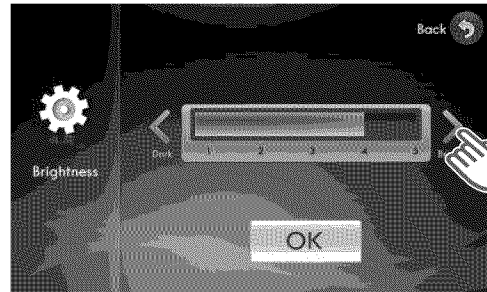

- To apply your new settings, touch the OK button.

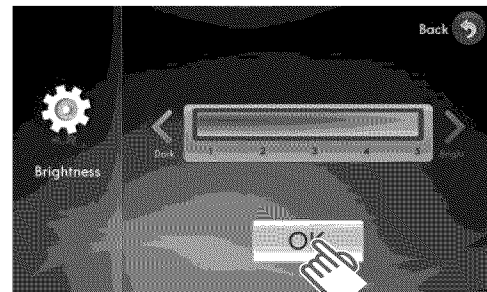

## How to set the screen brightness.

- Press the Home button. The display screen will show the “Home” screen.

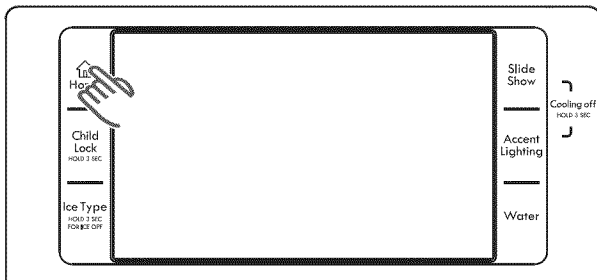

- Touch the Settings button in the lower right corner of the touch screen. The “Settings” selection screen will be displayed.

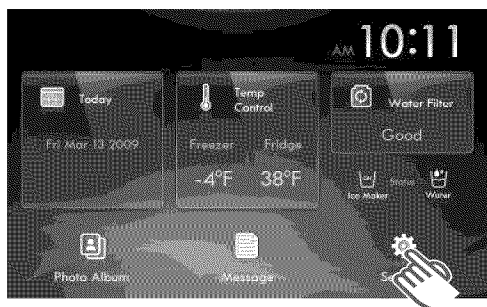

# USING YOUR REFRIGERATOR

## How to set the screen saver.

If the screen saver is left on for extended periods, it is a good idea to set the slide show at the photo album as the screen saver.

1. Press the Home button. The display screen will show the "Home" screen.

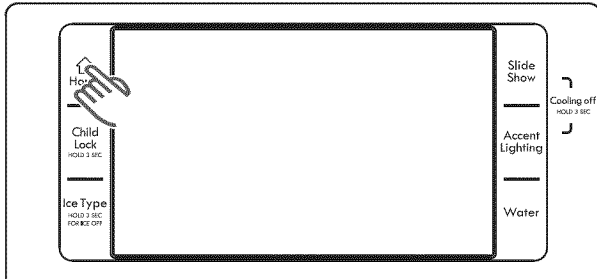

2. Touch the Settings button in the lower-right corner of the touch screen. The "Settings" selection screen will be displayed.



3. Touch the Screen Saver button on the left center of the touch screen. The Screen Saver screen will appear.

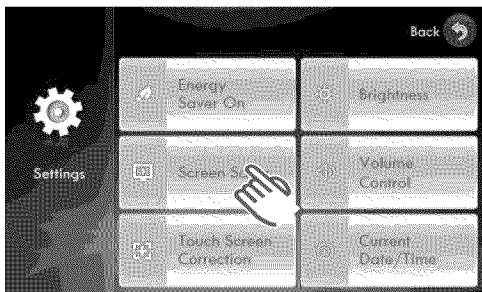

4. Use the < and > buttons to choose one of the six preset settings (0/3/5/10/30/60 minutes). The selected running time will appear on the screen.

### NOTES:

- After 60 seconds, the screen saver runs for the time you set; then the LCD panel turns OFF.
- If the screen saver running time is set for 0 minutes, the slide show will not run.

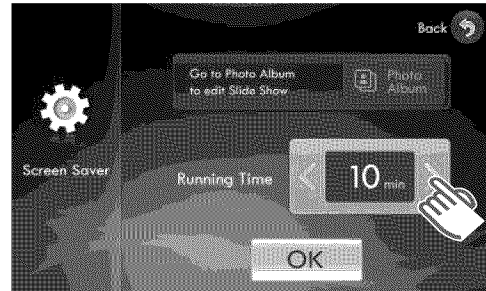

5. Touch the OK button to apply the new time setting.

**NOTE:** If the OK button is not touched before moving to other functions, the new time setting will not apply.

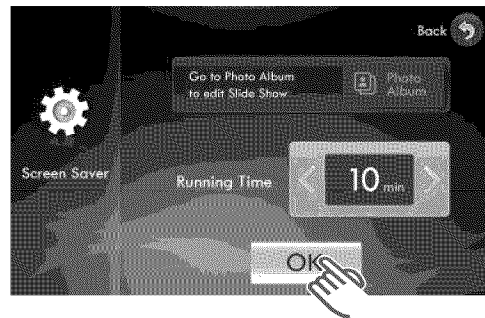

6. To change the slide show for the screen saver, select the Photo Album button. Refer to page 33 for "Setting Up a Slide Show From the Photo Album" instructions.

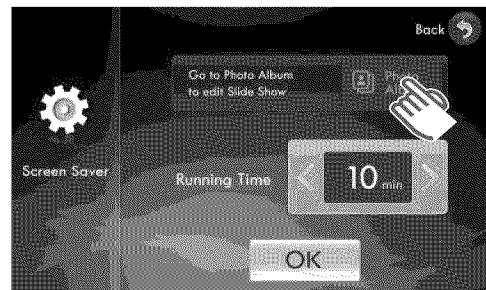

# USING YOUR REFRIGERATOR

## How to set the volume control.

You can control the volume of the alert sounds.

1. Press the Home button. The display screen will show the "Home" screen.
2. Touch the Settings button in the lower-right corner of the touch screen. The "Settings" selection screen will appear.

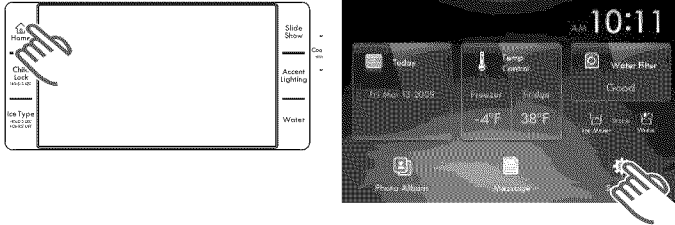

3. Touch the Volume Control button on the right-center of the touch screen. The "Volume Control" screen with the current setting will appear.

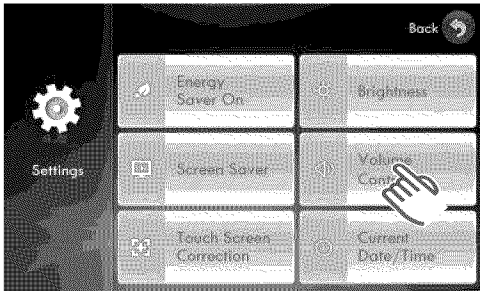

4. Touch the High and Low < and > buttons to adjust the alert sound level. The volume level bar will change as the volume changes.

**NOTE:** An alert sounds whenever a button is touched or a message window or menu list appears.



5. Touch the OK button to set the new volume level.

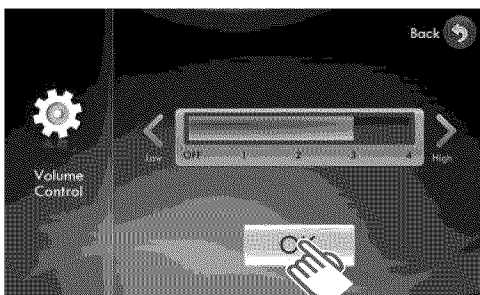

## How to change the current date and time.

1. Press the Home button. The display screen will show the "Home" screen.
2. Touch the Settings button in the lower-right corner of the touch screen. The "Settings" selection screen will appear on the screen.

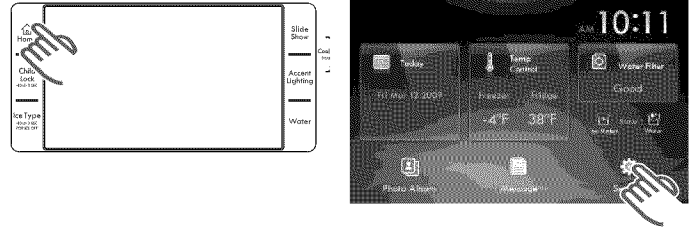

3. Touch the Current Date/Time button in the lower-right corner of the touch screen. The current date and time settings will appear on the screen.

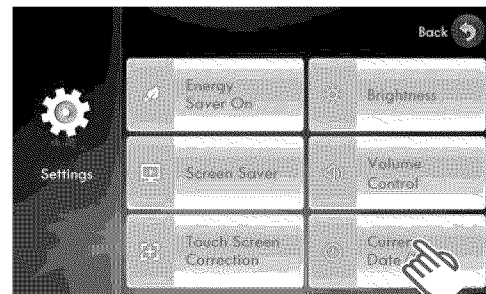

4. Use the < and > buttons to revise the date and time settings. The "Current Date/Time" screen will show the changes as they are made.

- Date settings display the year, month, and date.
- Time settings display the hours (AM or PM) and minutes.

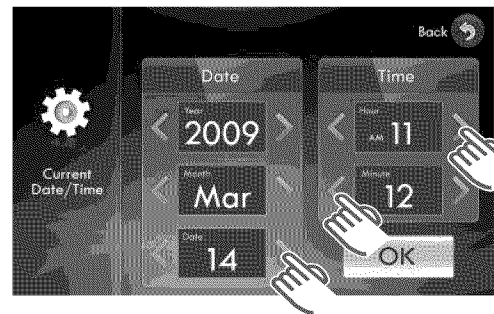

5. To apply your new settings, press the OK button.

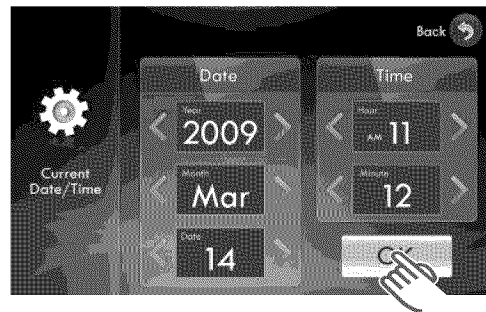

# USING YOUR REFRIGERATOR

## STORING FOOD IN THE REFRIGERATOR

The Kenmore Elite™ Side-By-Side Refrigerator has been designed with features and functions that maximize space saving. The following customized compartments help keep your food fresher longer. In order to further prevent odor from seeping into the ice, securely wrap stored foods as airtight as possible.

### DAIRY BIN

Can be used to store small dairy items like butter, margarine, yogurt, and cream cheese.

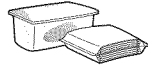

### TILT CAN CARRY

Can be used to store beverage cans or bottles.

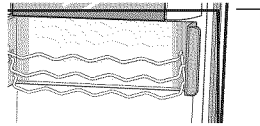

### OPTIONAL WINE RACK

Helps wines maintain their taste by providing an optimized place for storing your wine bottles.

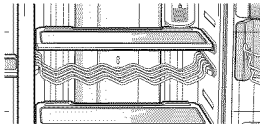

### TEMPERED GLASS SHELVES

Designed to be crack-resistant, the shelves can be used to store all types of food and drinks. Circular marks on the glass surface are a normal phenomenon and can usually be wiped clean with a damp cloth.

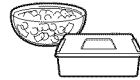

### FOLDABLE SHELF

This shelf folds to let the user quickly change the usable storage space to accommodate tall bottles and containers.

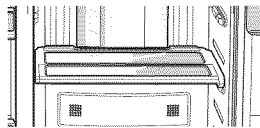

### REFRIGERATOR DOOR BINS

Designed to handle large, bulky items such as gallons of milk or other large bottles and containers.

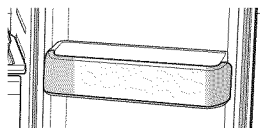

### EGG CONTAINER

Best place to keep eggs. Place the container on the shelf for easy access.

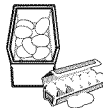

### DELI DRAWER

Designed to store and preserve deli items such as cold cuts and cheeses, and cuts of fresh meat.

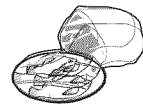

### FRUIT AND VEGETABLE CRISPERS

Used to preserve the freshness of your stored vegetables and fruits. This drawer has been specifically designed to control the level of humidity within the compartment. Keep vegetables and fruits separate, when possible.



## STORING FOOD IN THE FREEZER

### ICE BUCKET

Designed to store large amounts of ice.

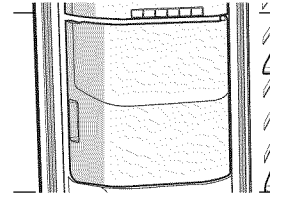

## ⚠ CAUTION

Do not use your fingers, hands, or any other objects in the ice chute or the icemaker bucket. This may result in personal injury or material damage.

### SLIDE-SHELVES

Can be used to store all types of frozen food.

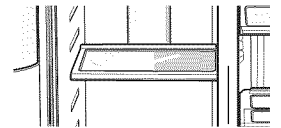

### FREEZER DOOR BINS

Can be used for small packages of frozen food.

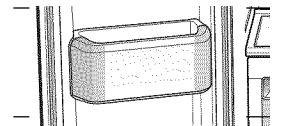

### FREEZER DRAWERS

Best used to store meats or dry foods. Stored food should be wrapped securely using foil or other suitable wrapping materials or containers.

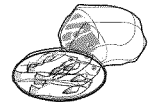

### FOOD STORAGE TIPS:

- DO NOT place any large items of food under the lamp in the refrigerator. An air sensor is located near the lamp and if the sensor is blocked, the refrigerator may become too cold.
- ALWAYS place vegetables and fruits in the vegetable and fruit crispers to avoid freezing.
- If the food in the refrigerator becomes frozen, please set the temperature higher.
- Bottles should be stored tightly together so that they do not tip and fall out when the refrigerator door is opened.
- If you plan to go away for an extended period, empty the refrigerator and turn it OFF. Wipe excess moisture from the inside of the appliance and leave the doors open. This helps keep odor and mold from developing.

## USING THE DOORS

The refrigerator and freezer doors have automatic door closers to ensure that the doors close and seal completely.

When a door is opened or closed to less than 3 inches, it will automatically close and seal. When a door is opened more than 3 inches, it will stay open until it is closed.

## USING YOUR REFRIGERATOR

### REMOVING THE REFRIGERATOR/ FREEZER ACCESSORIES

The Kenmore Elite™ Side-By-Side Refrigerator accessories can be easily removed and/or rearranged to maximize the use of interior space and provide ease of cleaning.

#### ⚠ CAUTION

Before removing any accessories, remove all food from the accessory being removed. This will avoid breakage and/or personal injury.

### Shelves (Refrigerator and Freezer)

#### ⚠ CAUTION

The tempered glass shelves are heavy. Use special care when removing them to avoid breaking them and/or personal injury.

#### To remove and relocate:

1. Slide the shelf out until the shelf support lines up with the opening in the side shelf retainer as shown.
2. Using both hands, tilt the shelf by lifting the right side as shown; then carefully remove the shelf from the refrigerator or freezer compartment.

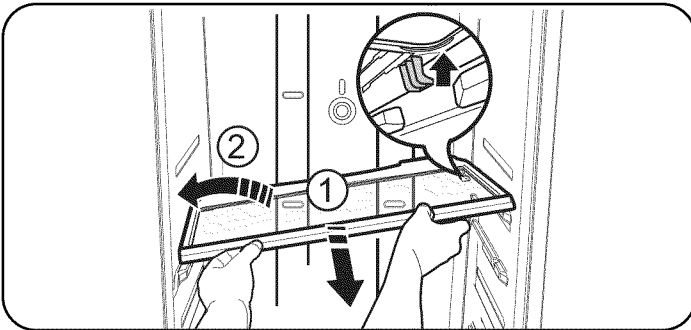

3. Holding the shelf in a tilted position, insert the left side of the shelf on the desired shelf support; then lower the right side of the shelf until it is also supported.
4. Slide the shelf all the way in to lock it in position.

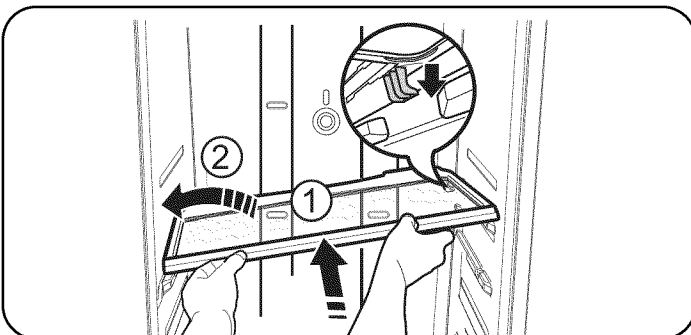

### Door Bins (Refrigerator and Freezer)

#### ⚠ CAUTION

Injury may occur if the door bins are not firmly installed. Do not allow children to play with the bins. Sharp corners of the bins may cause personal injury.

**NOTE:** DO NOT adjust a bin full of food.

#### To remove and relocate:

1. Lift up on the bin to unlatch; then pull it straight out to remove from the door.

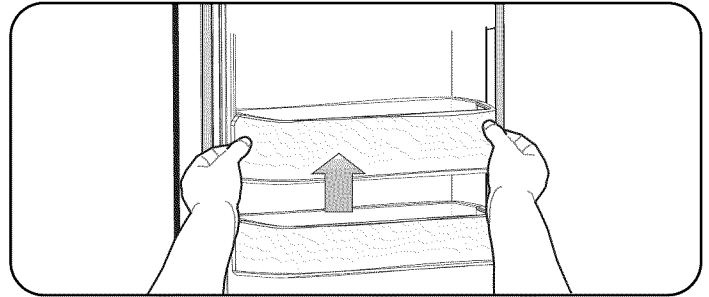

2. After relocating the bin, slide it in the door above the desired location and then push down until it stops. This will lock the bin in place.

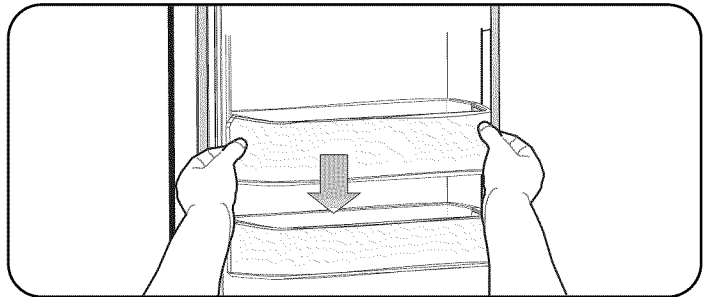

### Drawers/Crispers (Refrigerator and Freezer)

#### To remove and replace a drawer:

1. Slide the drawer out until it stops.
2. Slightly lift up on the front of the drawer and slide it out to remove it from the refrigerator or freezer compartment.

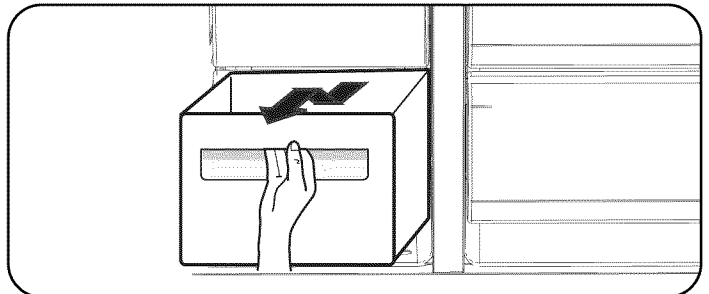

3. Reverse the order to replace the drawer.

# USING YOUR REFRIGERATOR

## Drawers/Crispers (cont.)

To remove and replace a drawer cover:

### ⚠ CAUTION

Do not use excessive force when removing a drawer cover. Forced drawer covers can break and/or cause personal injury.

1. Remove all the drawers as described on page 41.
2. Slide the drawer cover out until the cover supports line up with the openings in the side supports as shown; then carefully remove the drawer cover from the refrigerator or freezer compartment.

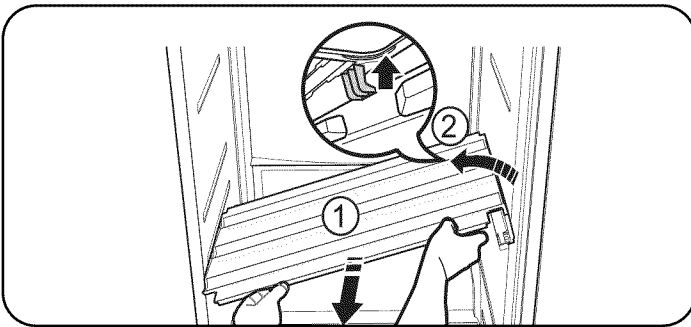

3. Using both hands, tilt the cover with the right side raised and position the left side on the desired shelf support. Lower the right side so the right cover support lines up with the opening in the side shelf support.
4. Slide the cover all the way in to lock it in position.

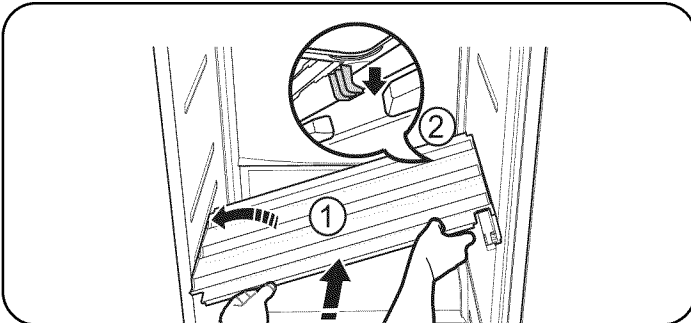

## Ice Bucket (Freezer)

To remove and replace:

### ⚠ CAUTION

Do not force the ice bucket during removal. Unnecessary force could cause damage to the icemaker.

1. Using both hands as shown, lift the ice bucket up while slowly pulling it out. Do not force the ice bucket during removal to prevent possible damage to the icemaker.

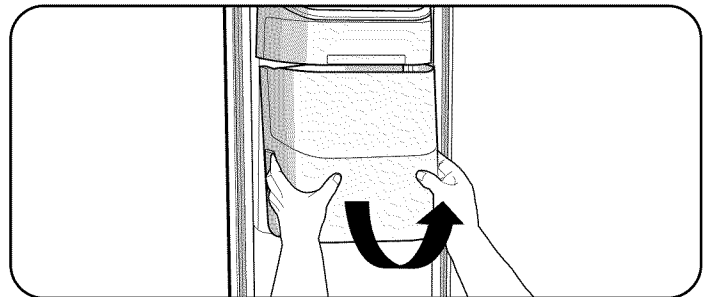

2. Replace the ice bucket by slightly tilting in the top of the ice bucket and sliding it into place.

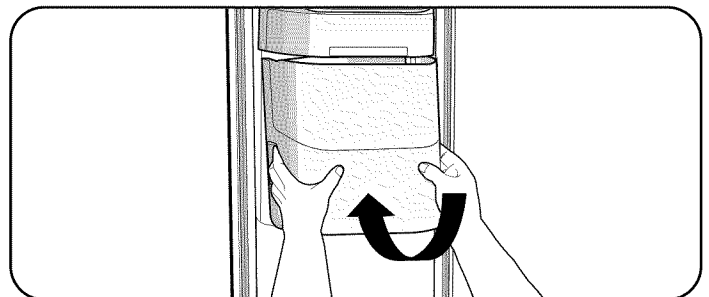

# CARE AND CLEANING

## CLEANING THE REFRIGERATOR

Caring for your Kenmore Elite™ Side-By-Side Refrigerator prolongs the life of your appliance and helps keep it odor- and germ-free.

### ⚠ CAUTION

Do not use benzene, thinner, or bleach for cleaning. They could cause a fire or damage the surface of the appliance.

### Cleaning the Interior

Clean the inside walls and accessories with a mild detergent and then wipe dry with a soft cloth. You can remove the drawers and shelves for a more thorough cleaning. Make sure to dry the drawers and shelves before putting them back into place.

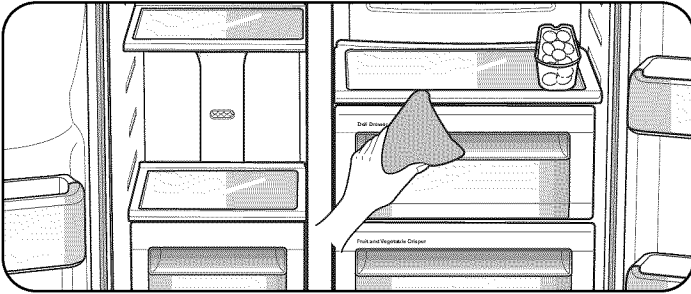

### Cleaning the Rubber Door Seals

Dirty door seals can prevent the doors from closing properly and lower the refrigerator's operating efficiency. Clean the door seals with a mild detergent and a damp cloth; then wipe dry with a clean, soft cloth.

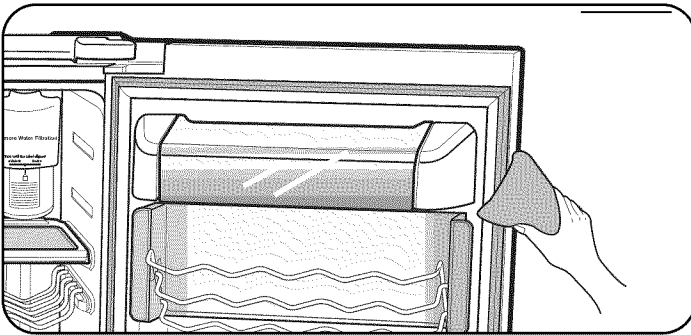

### Cleaning the Exterior

Wipe the digital panel and LCD display panel with a clean, soft cloth. Spray water onto the cleaning cloth instead of spraying directly on the surface of the refrigerator.

The doors, handles, and cabinet surfaces should be cleaned with a mild detergent and then wiped dry with a soft cloth.

To keep your appliance looking its best, the exterior should be polished once or twice a year.

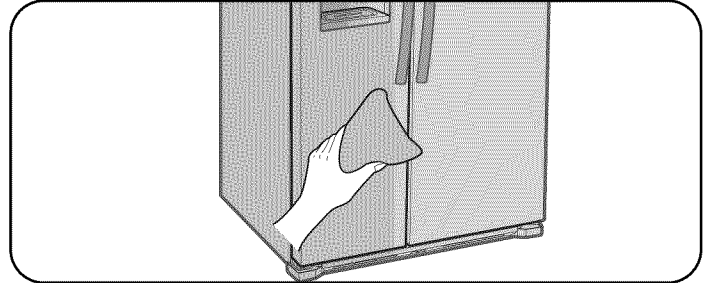

### Cleaning the Ice/Water Dispenser

### ⚠ WARNING

#### Electric Shock Hazard

Do not spray water on the refrigerator while it is plugged in. It could cause an electric shock resulting in death, personal injury, or damage to the appliance.

1. Push down one end of the tray in the bottom of the dispenser. Grasp the other end of the tray and remove it.
2. Wipe the dispenser with a clean, damp cloth; then dry with a soft cloth.
3. Wash the bottom tray in warm, soapy water; rinse and dry. Replace the tray in the bottom of the dispenser.

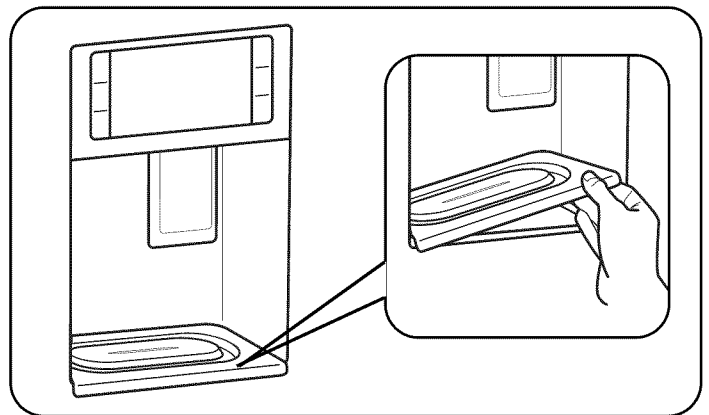

# CARE AND CLEANING

## Cleaning Behind the Refrigerator

### **⚠ WARNING**

#### **Electric Shock Hazard**

Do not remove the back cover. Doing so could cause an electric shock resulting in death, personal injury, or damage to the appliance.

To keep the cords and exposed parts free of dust and dirt accumulation, vacuum behind the appliance once or twice a year.

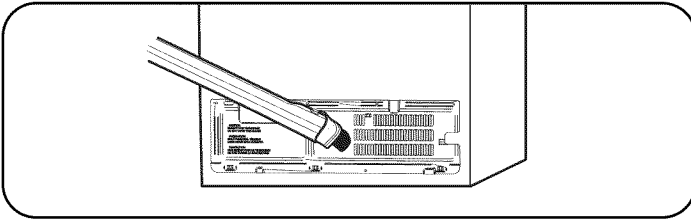

## REPLACING THE INTERIOR LIGHTS

### **⚠ WARNING**

#### **Electric Shock Hazard**

Do not attempt to replace any interior lights. Doing so could cause an electric shock resulting in death, personal injury, or damage to the appliance.

The interior lighting for this model uses LED lighting. DO NOT try to change an LED. LED lighting should only be replaced by a qualified Sears service technician.

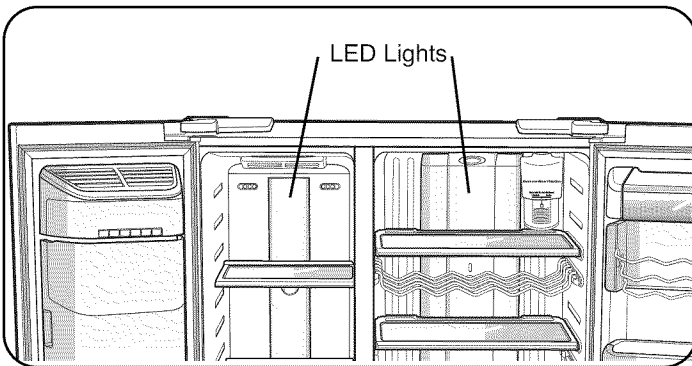

## CHANGING THE WATER FILTER

To check the condition of the water filter, press the Home button and then touch the Water Filter button on the top right of the touch screen. The current water filter status will be displayed on the screen followed by step-by-step servicing instructions. (See page 29.)

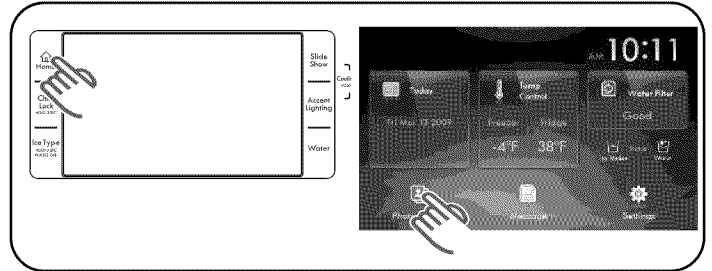

### **⚠ CAUTION**

DO NOT use the water or ice dispenser without a water filter cartridge because the water line may become blocked or damage the dispenser.

1. Remove the replacement water filter from the box and apply the appropriate month indicator sticker as shown. The sticker should show the month 6 months in the future. The normal filter life is about 6 months.
2. Remove the protective cap from the top of the new filter.
3. Remove the old filter by turning it counterclockwise and pulling down to remove it from the filter housing.
4. Position and insert the new filter into the filter housing.
5. Slowly turn the water filter clockwise to lock the filter in place and align it with the printed mark on the cover. Do not overtighten.

**NOTE:** Be sure to flush 3 gallons (11.4 liters) (approximately 6 minutes). This purges any air in the water lines that could cause the dispenser to drip.

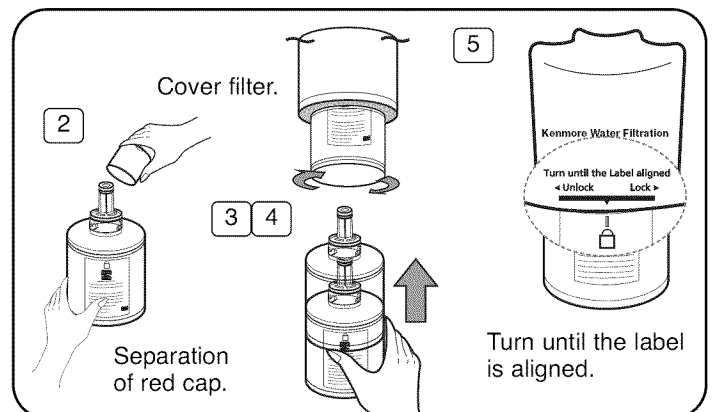

## POWER INTERRUPTIONS

1. If the power will be out for 24 hours or less, keep all refrigerator doors closed to help foods stay cold and frozen.
2. If the power will be out for more than 24 hours, remove all frozen food and store it in a frozen food locker.

## WHEN YOU GO ON VACATION

### **If you choose to leave the refrigerator on while you are away:**

1. Use up any perishables and freeze other items.
2. Empty the ice bin.
3. Turn off the icemaker.

### **If you choose to turn the refrigerator off before you leave:**

1. Remove all food from the refrigerator.
2. Unplug the power cord or turn off the circuit breaker or fuse box.
3. Clean the refrigerator interior. Make sure it has been thoroughly cleaned and wiped dry.
4. Tape rubber or wood blocks to the top of each door to prop them open far enough for air to get in. This stops odor and mold from building up.

## WHEN YOU MOVE

When you are moving your refrigerator to a new home, follow these steps to prepare it for the move.

1. Remove all food from the refrigerator and pack all frozen food in dry ice.
2. Unplug the power cord.
3. Clean the refrigerator interior. Make sure it has been thoroughly cleaned and wiped dry.
4. Take out all removable parts, wrap them well, and tape them together so they don't shift and rattle during the move. Refer to sections in "Using Your Refrigerator" for removing instructions.
5. Raise the front leveling legs by turning them clockwise as far as they will go. This will expose all the rollers to make it easier to move.
6. Turn off the water supply line to the refrigerator. Disconnect the water line behind the refrigerator.
7. Tape the doors shut and the power cord to the back of the refrigerator.

When you get to your new home, put everything back and refer to the "Refrigerator Installation" section for installation instructions.

# TROUBLESHOOTING GUIDE

## REFRIGERATOR DOES NOT OPERATE

Check if...	Then...
The power supply cord is unplugged.	Firmly plug the cord into a live outlet with proper voltage.
A household fuse has blown or circuit breaker tripped.	Replace the fuse or reset the circuit breaker.
Refrigerator is in defrost cycle.	Wait about 30 minutes for defrost cycle to end.

## REFRIGERATOR DOES NOT CHILL SUFFICIENTLY

Check if...	Then...
The power supply cord is unplugged.	Firmly plug the cord into a live outlet with proper voltage.
The temperature control on the display panel is not set to the correct temperature.	Reset the temperature control to a lower temperature.
Refrigerator is located in direct sunlight or near a heat source.	Relocate away from heat source.
The back of the refrigerator is located too close to the rear wall.	Make sure there is at least 3/8" of clearance between the back of refrigerator and rear wall.

## FROZEN FOOD IN THE REFRIGERATOR

Check if...	Then...
The temperature control on the display panel is not set to the correct temperature.	Reset the temperature control to a warmer temperature.
Room temperature is too low.	Make sure refrigerator is installed in a temperature control room.
Food is NOT stored properly in the refrigerator.	Relocate food to warmer section in the refrigerator. Example: Foods with high water content should not be stored in a Deli Drawer or a Fruit and Vegetable Crisper.

## UNUSUAL NOISE OR SOUNDS

Check if...	Then...
The refrigerator is level and stable.	Level and secure the refrigerator.
The back of the refrigerator is located too close to the rear wall.	Make sure there is at least 3/8" of clearance between the back of the refrigerator and the rear wall.
Anything was dropped behind or under the refrigerator.	Remove the dropped object.
A "ticking" sound is heard from inside the refrigerator.	It is normal and occurs when various accessories contact or expand due to temperature changes inside the refrigerator.
"Clunking" and "hissing" sounds are heard from inside the freezer.	They are normal and occur when ice drops into the ice bucket and water refills the icemaker.



## TROUBLESHOOTING GUIDE

### FRONT CORNERS AND VERTICAL HINGED SURFACES ARE HOT OR HAVE CONDENSATION

**Check if...**

**Then...**

Vertical hinged surfaces feel hot.	Some heat is normal due to installed anti-condensators. These prevent condensation buildup.
Refrigerator door is ajar.	Condensation can occur when you leave a door open for a long time.

### ICEMAKER NOT PRODUCING ICE

**Check if...**

**Then...**

The refrigerator was just installed.	The refrigerator must run for at 12 to 24 hours before making ice.
The water line is connected and water supply is turned on.	Connect the water supply line and open the shut-off valve.
The icemaker is turned off.	Check the digital display panel to make sure the icemaker is turned on.
The freezer temperature is too warm.	Reset the temperature control to a lower temperature.

### WATER BUBBLING SOUND

**Check if...**

**Then...**

There is a bubbling water sound in the refrigerator.	This is normal. The bubbling comes from the refrigerator coolant liquid circulating through the refrigerator.
--	---

### BAD SMELL IN REFRIGERATOR

**Check if...**

**Then...**

There is food spoiled in the refrigerator.	Throw away spoiled food.
Food is properly stored and wrapped.	Foods with strong odors, like fish, should be stored in airtight containers.
Old or spoiled food is in the freezer.	Clean out freezer compartment periodically. Throw away any spoiled or suspicious food.

### FROST ON WALLS OF THE FREEZER

**Check if...**

**Then...**

The air vent is blocked.	Remove any obstructions so air can circulate freely.
There is sufficient space around the food.	Allow sufficient space between foods stored for efficient air circulation.

### WATER DISPENSER IS NOT FUNCTIONING

**Check if...**

**Then...**

The water line is connected and/or the shut-off valve is open.	Connect the water supply line and open the shut-off valve.
The water supply line has been crimped or crushed.	Replace the water supply line.
The temperature in the freezer is too low.	Reset the temperature control to a warmer temperature.

## TROUBLESHOOTING GUIDE

### THE DISPLAY FUNCTIONS DO NOT WORK

Check if...	Then...
The display lock function is set to Locked.	Reset the display lock function to Unlocked.
The display lock function is set to Unlocked.	Push the display reset button with a sharp tool. This initializes the display. (Please note the user's information is not removed.)

### NOTHING ON THE “EXTERNAL ALBUM : UPLOAD PICTURES” OR “EXTERNAL ALBUM : PLAY SLIDE SHOW” SCREEN AFTER INSERTING MEMORY CARD

Check if...	Then...
The images are saved on your memory card (SD/SDHC/MMC/HS MMC).	Save the images on the memory card before inserting as an “External Album.” If no images are saved on the memory card, no images will appear on the screen.
The images are saved as JPEG files.	Only JPEG files are compatible with this screen. Resave files on memory card as JPEG files.
You waited long enough for the screen to read the memory card.	Depending on the card type, it takes between 4–30 seconds for images to load.

### LCD SCREEN IS FREQUENTLY OFF

Check if...	Then...
The LCD Backlight Off function is not set properly.	It is normal for the LCD screen to go blank after a period of time. This reduces the refrigerator's power consumption.
The “External Album : Upload Pictures,” “External Album : Play Slide Show,” or “What do you want to do?” screen turns off automatically.	The default time is 20 minutes for this screen use. This screen will go blank after the set screen saver time or if there is no user operation for 20 minutes.
The LCD goes blank before you are done using it.	The default time is 1 minute for all other screen uses. The screen will go blank after the set screen saver time or if there is no user operation for 1 minute.

### AFTERIMAGE OR BORDER LINES OCCUR ON THE SCREEN

Check if...	Then...
The image sizes are the same in Slide Show and Screen Saver modes.	<p>If all displayed images are the same size with blacked out borders on top, bottom, left, or right of the screen, the image can burn border lines and/or images into the screen. Always use a variety of image sizes in Slide Show and Screen Saver and change frequently to avoid this problem.</p> <p>If photos are not placed and rotated properly, permanent damage can occur to the LCD screen. This type of damage is not covered by the warranty.</p>

### INPUT POINT IN THE TOUCH SCREEN IS NOT CORRECT

Check if...	Then...
The input point in the touch screen is correctly set.	Do the touch screen correction from the “Settings” screen.

