



---

## AM/FM Stereo Dual Alarm Clock Radio With Top Loading CD Player



### USER MANUAL

**JCR-310**

**PLEASE READ THIS USER MANUAL COMPLETELY BEFORE OPERATING  
THIS UNIT AND RETAIN THIS BOOKLET FOR FUTURE REFERENCE.**

## DEAR JENSEN® CUSTOMER

Selecting fine audio equipment such as the unit you've just purchased is only the start of your musical enjoyment. Now it's time to consider how you can maximize the fun and excitement your equipment offers. This manufacturer and the Electronic Industries Association's Consumer Electronics Group want you to get the most out of your equipment by playing it at a safe level. One that lets the sound come through loud and clear without annoying blaring or distortion and, most importantly, without affecting your sensitive hearing.

Sound can be deceiving. Over time your hearing "comfort level" adapts to higher volumes of sound. So what sounds "normal" can actually be loud and harmful to your hearing. Guard against this by setting your equipment at a safe level BEFORE your hearing adapts.

### To establish a safe level:

- Start your volume control at a low setting.
- Slowly increase the sound until you can hear it comfortably and clearly, and without distortion.

### Once you have established a comfortable sound level:

- Set the dial and leave it there.

Taking a minute to do this now will help to prevent hearing damage or loss in the future. After all, we want you listening for a lifetime.

### We Want You Listening For a Lifetime

Used wisely, your new sound equipment will provide a lifetime of fun and enjoyment. Since hearing damage from loud noise is often undetectable until it is too late, this manufacturer and the Electronic Industries Association's Consumer Electronics Group recommend you avoid prolonged exposure to excessive noise.

### Customer's Record:

The serial number of this product is found on its bottom cover. You should note the serial number of this unit in the space provided as a permanent record of your purchase to aid in identification in the event of theft or loss.

Model Number: JCR-310

Serial Number: \_\_\_\_\_

# WARNINGS

**WARNING:**

To reduce the risk of fire or electric shock, do not expose this appliance to rain or moisture.

**CAUTION:**

Use of controls or adjustments or performance of procedures other than those specified may result in hazardous radiation exposure.



**CAUTION - TO REDUCE THE RISK OF ELECTRIC SHOCK, DO NOT REMOVE COVER (OR BACK). NO USER-SERVICING TO QUALIFIED SERVICE PERSONNEL.**



The lightning flash with arrowhead symbol, within an equilateral triangle, is intended to alert the user to the presence of uninsulated “dangerous voltage” within the product’s enclosure that may be of sufficient magnitude to constitute a risk of electric shock to persons.



The exclamation point within an equilateral triangle is intended to alert the user to the presence of important operating and maintenance (servicing) instructions in the literature accompanying the appliance.

## **IMPORTANT SAFETY INSTRUCTIONS**

- 1) Read these Instructions.
- 2) Keep these Instructions.
- 3) Heed all Warnings.
- 4) Follow all Instructions.
- 5) Do not use this apparatus near water.

- 6) Clean only with a dry cloth.
- 7) Do not block any ventilation openings. Install in accordance with the manufacturer's instructions. The appliance should be situated so that its location or position does not interfere with its proper ventilation. For example, the appliance should not be situated on a bed, sofa, rug, or similar surface that may block the ventilation openings; or placed in a built-in installation, such as a bookcase or cabinet that may impede the flow of air through the ventilation openings.
- 8) Do not install near any heat sources such as radiators, heat registers, stoves, or other apparatus (including amplifiers) that produce heat.
- 9) Do not overload wall outlet. Use only power source as indicated.
- 10) Do not defeat the safety purpose of the polarized or grounding-type plug. A polarized plug has two blades with one wider than the other. A grounding type plug has two blades and a third grounding prong. The wide blade or the third prong are provided for your safety. When the provided plug does not fit into your outlet, consult an electrician for replacement of the obsolete outlet.
- 11) Protect the power cord from being walked on or pinched particularly at plugs, convenience receptacles, and the point where they exit from the apparatus.
- 12) Main plug is used as disconnect device and it should remain readily operable during intended use. In order to disconnect the apparatus from the mains completely, the mains plug should be disconnected from the mains socket outlet completely.
- 13) Only use attachments/accessories specified by the manufacturer.
- 14) Use only with a cart, stand, tripod, bracket, or table specified by the manufacturer, or sold with the apparatus. When a cart is used, use caution when moving the cart/apparatus combination to avoid injury from tip-over.
- 15) Unplug this apparatus during lightning storms or when unused for long periods of time.
- 16) This apparatus shall not be exposed to dripping or splashing and that no objects filled with liquids, such as vases, shall be placed on apparatus.
- 17) Refer all servicing to qualified service personnel. Servicing is required when the apparatus has been damaged in any way, such as power-supply cord or plug is damaged, liquid has been spilled or objects have fallen into the apparatus, the apparatus has been exposed to rain or moisture, does not operate normally, or has been dropped.
- 18) Do not attempt to dismantle, open or repair this product yourself. If a fault occurs, seek advice from your local qualified service technician or contact the distributor via the telephone number at the back of this instruction manual.
- 19) Battery shall not be exposed to excessive heat such as sunshine, fire or the like.
- 20) Caution marking and nameplate are located on bottom of product.



The symbol for Class II (double insulation)

21) **CAUTION**

Danger of explosion if battery is incorrectly replaced. Replace only with the same or equivalent type.



**CAUTION:**

**TO PREVENT ELECTRIC SHOCK, MATCH WIDE BLADE OF PLUG TO WIDE SLOT. FULLY INSERT THE PLUG TO MAIN POWER SOCKET.**

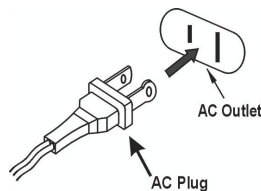

# SAVE THESE INSTRUCTIONS

## IMPORTANT NOTE

Avoid installing the unit in locations described below:

- Places exposed to direct sunlight or close to heat radiating appliances such as electric heaters.
- Places subject to constant vibration.
- Dusty, humid or moist places.
- Sources of electrical noise such as fluorescent lamps or motors.
- In case of malfunction due to electrostatic discharge, the apparatus has to be reset by disconnecting it from mains supply and removing all the batteries. Wait at least for 30 seconds before reconnect the AC power cord or reinstall the batteries.

## CAUTION

### CLASS 1 LASER PRODUCT

CLASS 1 LASER PRODUCT  
APPAREIL LASER DE CLASSE 1  
PRODUCTO LASER DE CLASE 1

CAUTION  
INVISIBLE LASER RADIATION  
WHEN OPEN AND INTERLOCKS  
DEFEATED.  
AVOID EXPOSURE TO BEAM

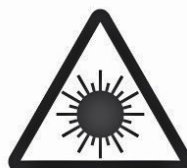

This product contains a low power laser device.

**Note:** This product complies with DHHS Rule 21 Subchapter J at date of manufacture. Follow the advice below for safe operations.

## ON PROTECTION AGAINST LASER ENERGY EXPOSURE

- As the laser beam used in this compact disc player is harmful to the eyes, do not attempt to disassemble the casing.
- Stop operation immediately if any liquid or solid object should fall into the cabinet.
- Do not touch the lens or poke at it. If you do, you may damage the lens and the player may not operate properly.
- Do not put anything in the safety slot. If you do, the laser diode will be ON when the CD door is still open.
- This unit employs a laser. The use of controls or adjustment or performance of procedures other than those specified here may result in exposure to hazardous radiation.

## ON PLACEMENT

- Do not use the unit in places which are extremely hot, cold, dusty, or humid.
- Place the unit on a flat and even surface.
- Do not restrict the air flow of the unit by placing it in a place with poor air flow, by covering it with a cloth, or by placing it on a carpet.

## ON SAFETY

- When connecting and disconnecting the AC power, grip the AC cord plastic plug and not the cord itself. Pulling the cord may damage it and create hazard.
- When you are not going to use the unit for a long period of time, disconnect the AC power cord from the wall outlet and remove all batteries.

## **ON AC VOLTAGE**

- Before use, check that the rated voltage of your unit matches your local voltage.

## **ON CONDENSATION**

- When left in a heated room where it is warm and damp, water droplets or condensation may form inside the CD player.
- When there is condensation inside the unit, the unit may not function normally.
- Let it stand for 1 to 2 hours before turning the power on, or gradually heat the room up and dry the unit before use.

**Should any trouble occur, disconnect the AC power cord and refer servicing to qualified personnel.**

## **COMPLIANCE WITH FCC REGULATIONS**

This device complies with Part 15 of the FCC Rules. Operation is subject to the following two conditions:

- (1) this device may not cause harmful interference, and
- (2) this device must accept any interference received, including interference that may cause undesired operation.

**NOTE :** This equipment has been tested and found to comply with the limits for a Class B digital device, pursuant to Part 15 of the FCC Rules. These limits are designed to provide reasonable protection against harmful interference in a residential installation. This equipment generates, uses and can radiate radio frequency energy and, if not installed and used in accordance with the instructions, may cause harmful interference to radio communications. However, there is no guarantee that interference will not occur in a particular installation. If this equipment does cause harmful interference to radio or television reception, which can be determined by turning the equipment off and on, the user is encouraged to try to correct the interference by one or more of the following measures:

- Reorient or relocate the receiving antenna.
- Increase the separation between the equipment and receiver.
- Connect the equipment into an outlet on a circuit different from that to which the receiver is connected.
- Consult the dealer or an experienced radio/TV technician for help.

**CAUTION: Changes or modifications not expressly approved by the party responsible for compliance could void the user's authority to operate the equipment.**

## **PROTECT YOUR FURNITURE!!**

This system is equipped with non-skid rubber 'feet' to prevent the product from moving when you operate the controls. These 'feet' are made from non-migrating rubber material specially formulated to avoid leaving any marks or stains on your furniture. However certain types of oil based furniture polishes, wood preservatives, or cleaning sprays may cause the rubber 'feet' to soften, and leave marks or a rubber residue on the furniture.

To prevent any damage to your furniture we strongly recommend that you purchase small self-adhesive felt pads, available at hardware stores and home improvement centers everywhere, and apply these pads to the bottom of the rubber 'feet' before you place the product on fine wooden furniture.

## LOCATION OF CONTROLS

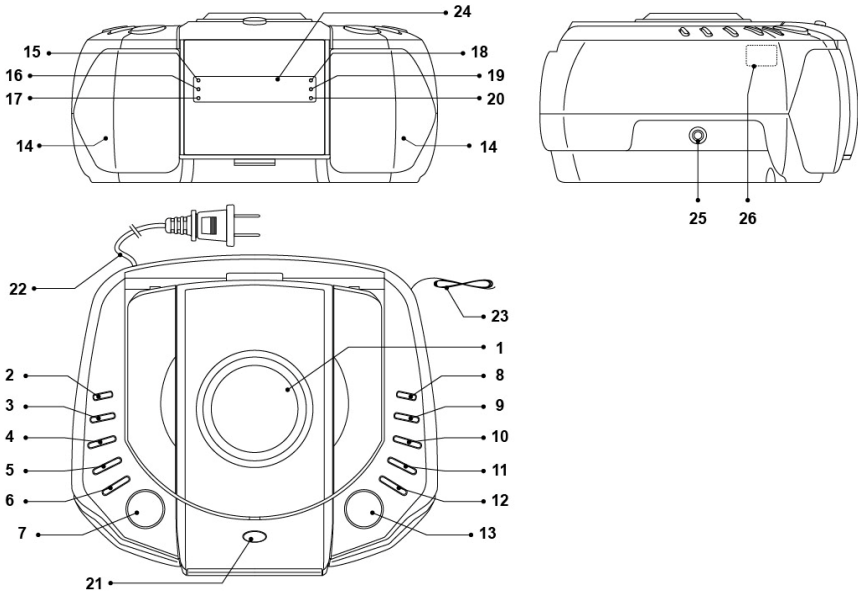



- |   |   |
|---|---|
| <p>1. CD Door</p> <p>2. Power On/Standby  ; FUNCTION button</p> <p>3. DISPLAY button</p> <p>4. TIME SET/MEMORY/MEM+ button</p> <p>5. ALARM 2/VOLUME- button</p> <p>6. ALARM 1/VOLUME+ button</p> <p>7. SNOOZE /SLEEP button</p> <p>8. CD PROGRAM button</p> <p>9. CD REPEAT button</p> <p>10.  Tune/Skip/Search Backward button</p> <p>11.  Tune/Skip/Search Forward button</p> <p>12. CD STOP  button</p> <p>13. CD PLAY/PAUSE  button</p> | <p>14. SPEAKERS</p> <p>15. PM Indicator</p> <p>16. ALARM 1 - Beeping Indicator</p> <p>17. MUSIC 1 - Wake to CD/Radio/AUX Alarm Indicator</p> <p>18. REPEAT Indicator</p> <p>19. ALARM 2 - Beeping Indicator</p> <p>20. MUSIC 2 - Wake to CD/Radio/AUX Alarm Indicator</p> <p>21. CD Door Open Button</p> <p>22. AC Power Cord</p> <p>23. FM Wire Antenna</p> <p>24. LED Display</p> <p>25. AUX-IN Jack</p> <p>26. Back-up Battery Compartment (inside the CD compartment)</p> |
|---|---|

## POWER SOURCE

This unit operates using standard 120V~ 60Hz AC household power and 2 “AA” size (UM-3) batteries (Not included) for alarm clock backup.

### A. AC POWER CONNECTION

1. Plug the AC power cord into a standard 120V~ 60Hz AC wall outlet.
2. Tap the Power On/Standby  button to turn on the unit.
3. Tap the FUNCTION button to change the operation mode.
4. Press and hold the Power On/Standby  button to turn the unit into “STANDBY” mode after you finish listening.

### B. BATTERY BACK-UP FOR CLOCK SETTINGS

The battery back-up compartment is located inside the CD compartment.





1. Open the CD door and remove the battery compartment door.
2. Follow the polarity diagram shown inside the compartment and install 2 x AA (UM-3) batteries (not included).
3. Replace the battery compartment door.

**NOTE:** Only use a well-known brand of battery to ensure the longest life and best performance.

### BATTERY CARE

- Batteries shall not be exposed to excessive heat such as sunshine, fire or the like.
- Be sure that the batteries are installed correctly. Wrong polarity may damage the unit.
- Do not mix old and new batteries.
- Do not mix alkaline, standard (carbon-zinc) or rechargeable (nickel-cadmium) batteries.
- Only batteries of the same or equivalent type as recommend are to be used.
- If the unit is not to be used for an extended period of time, remove all batteries. Old or leaking battery can cause damage to the unit and may void the warranty.
- Do not dispose batteries in fire. Batteries may leak or explode.
- Danger of explosion if battery is incorrectly replaced.

## CLOCK SETTING

1. With the unit in Standby mode, press and hold the TIME SET button for about 1 second or until the “hour digits” begin to flash on the display.
2. Press the  /  buttons to adjust the hour.  
**NOTE:** Make sure the hour is set so that **PM** indicator is displayed correctly.
3. When the correct hour is selected, press the TIME SET button to confirm and the “minute digits” will begin to flash on the display.
4. Press the  /  buttons to adjust the minutes.
5. When the correct minute is selected, press the TIME SET button again to complete the setting.

## ALARM OPERATION

### SETTING THE ALARMS

1. With the unit in Standby mode, press the ALARM 1 or ALARM 2 button to select the ALARM wake up sound mode - “Beeping Alarm”, “Music from CD”, “Music from your external music player via AUX IN” or “Last AM/FM radio station you listened to (this will depend on what you last listened to before putting the unit into Standby mode)”. The relative alarm indicator ALARM 1/ALARM 2 or MUSIC 1/MUSIC 2 will light up to show your selection.

- If you select Wake to music, please set the volume level of music/radio with the power ON before putting the unit into Standby mode. The volume you set will be the same volume level that you come on when the alarm time is reached.

**Note:** 1.) For Wake to music from CD, please make sure a CD is inserted and can be properly played, otherwise the unit will default to the “Beeping” alarm sound automatically. Make sure the CD inserted can be played properly at desired volume level before you turn the unit into Standby mode for next day wake up alarm.

2.) For Wake to music from AUX, please make sure your external player has been properly connected to JCR-310 and has sufficient power to maintaining it’s continually playback before you turn the unit into Standby mode for next day wake up alarm. The unit that is connected to the AUX-IN must be left playing continuously in order to play properly when the wake time is reached.

3.) If you select Wake to music from Radio, make sure your AM/FM radio station is set to the station you want to be woken up to. The JCR-310 will play the last radio station you listened to when the wake time is reached.

- After selecting the alarm sound mode, press and hold the respective ALARM button. The alarm “hour digits” will begin to flash on the display. Press the ► / ◀ buttons to adjust the alarm hour.

**NOTE:** Make sure the hour is set so that **PM** indicator is displayed correctly for the chosen wake time.

- When the correct alarm hour is selected, press the corresponding ALARM button to confirm and the alarm “minutes digits” will begin to flash.
- Press the ► / ◀ buttons to adjust the alarm minute.
- When the correct alarm minute is selected, press the corresponding ALARM button to complete the setting.

### **TURNING THE ALARMS ON AND OFF**

- After you have set alarm time, tap the ALARM 1 or ALARM 2 button repeatedly to select the alarm function.

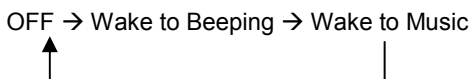

- Tap the respective alarm button to the wake up mode you desired and then wait for few seconds to confirm. The alarm clock stops flashing and selected alarm indicator ALARM 1 / ALARM 2 or MUSIC 1 / MUSIC 2 lights steadily.
- Tap the respective alarm button to OFF mode if you want to turn off the next day alarm. The corresponding alarm indicator goes off.

### **WAKE TO BEEPING ALARM**

- The Beeping Alarm will automatically turn on when the alarm time is reached. The respective ALARM 1 or ALARM 2 indicator will blink.
- The beep alarm will sound for 60 minutes and then turn off automatically if the snooze button is not pressed.
- To stop the beep alarm sound immediately, tap the Power ⏻ button.

### **WAKE TO MUSIC**

- When the alarm time is reached, the unit will automatically turn on the CD, AUX or Radio mode based on the last mode you were listening to before switching the unit to Standby mode. The respective MUSIC 1 or MUSIC 2 alarm indicator will blink.
- The alarm sound level will be the last volume level you listened to.
- The music alarm will sound for 60 minutes and then turn off automatically if the snooze button is not pressed.







- To stop the music alarm immediately, tap the Power  button.

### **SNOOZE FUNCTION**

- When the alarm sounds, it can be temporarily stopped by pressing the SNOOZE button. The alarm sound will be suspended but the relative alarm indicator will keep flashing.
- The alarm will turn off for 9 minutes and then come again.
- This manual snooze operation can be repeated again and again during alarm sounding period.

## **LISTENING TO RADIO**

### **Radio Tuning**

1. Tap the  / FUNCTION button repeatedly to select AM or FM radio mode.
2. To manually tune to a desired station, repeatedly tap the  /  buttons.
3. To automatically search for stations with strong signals, press and hold either of the  /  buttons until the frequency digits on display begins to scan then release the button. The tuner will stop on the first strong station it finds.
4. Press the Volume Up (+) and Volume Down (-) buttons to adjust the volume output level.
5. Tap the DISPLAY button to show the current station frequency on the display. The station frequency will revert back to show the time automatically after about 5 seconds.
6. Press and hold the  / FUNCTION button to turn unit into standby mode after listening.

#### **Notes:**

- Manual tune to select weaker stations that might be skipped during automatic tuning.
- If the automatic tuning does not stop on the exact frequency of the station, for example, it stops on 88.9 MHz instead of 88.8 MHz, use the manual tuning method to "fine tune" to the exact frequency of the desired station.







### **HINTS FOR BEST RECEPTION:**

- AM - The AM antenna is located inside the cabinet of the unit. If AM reception is weak, change the position of unit until the internal antenna picks up the strongest signal.
- FM - To insure maximum FM tuner reception, unwrap and fully extend the FM antenna wire for the best FM radio reception.

### **Radio Station Presets**

The unit allows you to store up to 10 AM and 10 FM stations for easy recall at any time.



### **Setting Preset Stations**

1. Tap the  / FUNCTION button to turn on the unit.
2. Tap the  / FUNCTION button to select AM or FM radio mode.
3. Tune to the radio station you want to store in memory by using the  /  buttons.
4. Press and hold the MEMORY button, the preset channel number appears on display and blinks.
5. To select desired preset station number, tap the  /  buttons.
6. To confirm preset location, tap the MEMORY button.
7. Repeat steps 3 to 6 to store other stations if necessary.

#### **Notes:**

- There is an approximate 7 seconds delay when programming, after 7 seconds, the unit will automatically switch back to normal tuner mode.
- You can overwrite a preset station by overwriting and storing the new frequency in its place.

### **Recalling a Preset Station**

1. Tap the  / FUNCTION button to turn on the unit.
2. Tap the  / FUNCTION button to select AM or FM radio receiving mode.
3. To select desired preset channel, tap the MEM+ button repeatedly.



## **CD OPERATION**

This CD player not only plays commercial CDs, but also self-compiled CD-R/RW discs. Do not attempt to play any of the following formats: CD-ROM, CDI, VCD, DVD or computer CDs.

### **NOTES ON CD-R/RW DISCS**

- Because of non-standardized format definition/production of CD-R/RW, playback quality & performance are not guaranteed.
- Manufacturer is not responsible for the playability of CD-R/RW due to recording conditions such as PC performance, writing software, media ability, etc.
- Do not attach a label or seal to either side of the CD-R/RW disc. It may cause a malfunction.

### **INSERTING AN AUDIO CD DISC**

1. Press the OPEN button to open the CD door. Carefully place an audio CD disc with its label side facing upward in the CD compartment and gently close the CD door.
2. Tap the  / FUNCTION button to turn on the unit.
3. Tap the  / FUNCTION button to select CD mode.
4. The unit will read the CD disc automatically, display will briefly show flashing “- -” then the total number of tracks on the CD.
5. If no disc is inserted or if the inserted disc is not recognized, the display will show the message “NO”. If the CD door is not closed, the display will show “OP”.



### **NOTES:**

- Keep the CD door closed when the system is not in use to prevent dirt and dust from entering the CD mechanism.
- Never place more than one CD in the CD tray. If two discs are loaded at the same time, the CD mechanism may jam and / or the discs themselves may be damaged.



### **AUDIO CD DISC PLAYBACK**

1. When the CD door is closed and a CD is inside, press the **PLAY/PAUSE**  button to start CD playback.
2. Adjust the **VOLUME** control to obtain the desired sound level from the Built-in Speakers.

### **IMPORTANT!!**

If the disc is smudged or scratched it may skip or stop completely. This does not indicate a problem with the player. If this occurs, try playing another disc. If that disc plays properly, you may assume that the first disc is damaged and unplayable.

### **PLAY/PAUSE MODE**

1. To temporarily stop playback while the CD disc is playing, press the  button once. The track number playing will be flashing, playback is now paused.
2. The sound pauses, but the disc will continue to spin. To re-start playback, press the  button again. The music will start from the exact position where it was paused.

- In clock display mode, tap the DISPLAY button to show the current track number on the display. The current track number will revert back to show the time after 30 seconds.
- To stop the CD playback, press the **STOP** ■ button once.

### SKIP and SEARCH MODE

- In play or pause mode, press the Tune/Skip/Search Forward ►► button once to skip forward to the next track or repeatedly to skip multiple tracks. Press the Tune/Skip/Search Backward ◄◄ button to return to the beginning of the track, or press the button repeatedly to skip backward several tracks.
- During play mode, when the ►► or ◄◄ button is pressed and held, the unit will do a high speed audible search of the track, either forward or backward depending on which button is pressed.

**Note:** Track number will change to show current time after 30 seconds if no CD operation button being pressed.

### REPEAT MODE

- Repeat One:**  
In the CD play mode, press the REPEAT button once, the REPEAT indicator will light on the display and flash. This single track of music will be repeated.
- Repeat All:**  
In the CD play mode, press the REPEAT button twice, the REPEAT indicator will show on the display steadily. The whole disc will be played repeatedly.
- To cancel repeat function**  
Press the **REPEAT** button repeatedly until Repeat Indicator goes off on the display. Standard playback mode will now resume.

### PROGRAM MODE

- In CD mode, press the STOP button to stop CD playback, total tracks of the CD will display.
- Press the PROGRAM button on unit, the program location and program track number "1:00" will display and program track digits "00" flash.
- Press the ►► / ◄◄ button to choose your desired musical track. For example, track 5 is selected, "05" will show in display and flash.
- Press the PROGRAM button again to store this track in memory. The LED display will go to "2:00" and track number digits keep flashing to prompt for input next track.
- Repeat the above procedures 3 - 4 until all desired tracks are stored. A total of 20 tracks can be stored for CD playback.
- After you finish programming 20<sup>th</sup> tracks, program location display will stop at 20 and will not further advance.
- Press the ►|| button once to start the program playback.
- To cancel the programmed memory, press the ■ button twice or open the CD door during the stop mode.

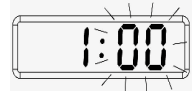

## SLEEP TIMER FUNCTION

The sleep timer allows you to turn the unit off after a designated time is reached.

1. To activate the sleep timer, turn the unit on and either load a CD, tune to the desired radio station or listening to music via AUX IN.
2. Tap the SLEEP button and the sleep time appears on the display.
3. Repeatedly tap the SLEEP button to select a sleep time. The unit will turn off after 10, 20, 30, 40, 50, 60, 70, 80 or 90 minutes. Wait 5 seconds after your selection for the unit to confirm the selection, the unit will play for the selected length of time then automatically turn off.
4. To cancel the sleep timer, press the SLEEP buttons until timer shows "OFF", the unit will turn into standby mode after 2 seconds.
5. To turn the unit off before the selected length of time, press the Power  $\odot$  button at any time.

### Notes:

- 1.) To check the remaining sleep time, tap the SLEEP button once.
- 2.) If you are falling asleep to music from an external device connected to the AUX input, the sleep timer will shut off the power to this system but it will not turn off the external device.

## AUXILIARY INPUT OPERATION

This unit provides an auxiliary audio signal input jack for connecting external audio devices like MP3 players, CD players and iPods (except iPod shuffle 3rd gen) and listen to your external source through the speakers of this system.

1. Use an audio cable (not included) with one 3.5 mm stereo plug on each end of the cable.
2. Plug one end into the AUX-IN jack located on the left hand side of the unit and the other end of the cable into the Line-out Jack or Headphone Jack of your external audio device.
3. Turn on the external audio device.
4. Tap the  $\odot$  / FUNCTION button to select AUX mode, "AUH" will show on display for few seconds before show current time.
5. The volume level can now be controlled through the main unit. Operate all other functions on the auxiliary device as usual.

### Note:

- (1) If you connected the Line-out Jack of your external device then you only need to adjust the volume control of this system. If you connected the Headphone Jack of your external device then you may need to adjust both the volume control of your external device and the volume control of this system to find the most desirable volume setting.
- (2) Remove the audio cable from AUX IN jack when you finish listening. Don't forget to switch off the power on your external device as well.

## CARE AND MAINTENANCE

1. Avoid operating your unit under direct sunlight or in hot, humid or dusty places.
2. Keep your unit away from heating appliances and sources of electrical noise such as fluorescent lamps or motors.
3. If drop-outs or interruptions occur in the music during CD play, or if the CD fails to play at all, its bottom surface may require cleaning. Before playing, wipe the disc from the center outwards with a good soft cleaning cloth.
4. Unplug the unit from the electrical power outlet immediately in case of malfunction.

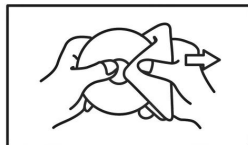

### Cleaning the Unit

- To prevent fire or shock hazard, disconnect your unit from the AC power source when cleaning.
- The finish on the unit may be cleaned with a dust cloth and cared for as other furniture. Use caution when cleaning and wiping the plastic parts.
- If the cabinet becomes dusty wipe it with a soft dry dust cloth. Do not use any wax or polish sprays on the cabinet.
- If the front panel becomes dirty or smudged with fingerprints it may be cleaned with a soft cloth slightly dampened with a mild soap and water solution. Never use abrasive cloths or polishes as these will damage the finish of your unit.

**CAUTION:** Never allow any water or other liquids to get inside the unit while cleaning.

## TROUBLESHOOTING GUIDE

If you experience difficulties in the use of this Docking System, please check the following or call 1-800-777-5331 for Customer Service.

Symptom	Possible Problem	Solution
Unit does not respond (no power)	AC power cord is not plugged properly into a wall outlet or the connector is not plugged into the AC Socket on the back of the System.	Re-plug the AC power cord into the wall outlet and the connector into AC Socket on the System.
	Wall outlet is not functioning.	Plug another device into the same outlet to confirm the outlet is working.
Radio no sound	Unit not in RADIO function mode. Volume set at minimum	Tap <b>FUNCTION</b> button to AM/FM RADIO position. Increase Volume
Noise or sound distorted on AM or FM broadcast	Station not tuned properly for AM or FM. FM: Wire antenna is not fully extended. AM: The reception at the set location is poor.	Retune the AM/FM broadcast station. FM: Fully extend or reposition the FM wire antenna. AM: Change the position for the best reception.

CD disc does not play	Unit not in CD function mode. Audio disc is installed incorrectly. If the disc is self-compiled, the media used may not be compatible with the player.	Select CD mode.  Insert audio disc with label side up. Use better quality blank media and retest.
Audio disc skips while playing	Disc is dirty or scratched.	Wipe disc with clean cloth or use another disc.
Intermittent sound from the player	Dirty or defective disc  Dirty pick up lens  Player is subject to excessive shock or vibration	Clean or replace the defective disc Use a lens cleaning disc to clean the lens Relocate the player away from shock or vibration
Unit gets warm after extended play at high volume	This is normal.	Turn the unit off a period of time or lower volume.

## SPECIFICATIONS

### **Power Requirement**

Main Unit: 120V~ 60Hz

Backup Battery for Clock: 2 x 1.5V "AA" (UM-3)

### **Frequency Range**

Radio Band AM 520 – 1710 KHz  
FM 87.5 - 108 MHz

### **Power Consumption**

Main Unit: 10 Watts



At Spectra, environmental and social responsibility is a core value of our business. We are dedicated to continuous implementation of responsible initiatives with an aim to conserve and maintain the environment through responsible recycling.

Please visit us at <http://www.spectrainl.com/green.htm> for more information on Spectra's green initiatives or to find a recycler in your area.

## 90 DAY LIMITED WARRANTY AND SERVICE VALID IN THE U.S.A ONLY

SPECTRA MERCHANDISING INTERNATIONAL, INC. warrants this unit to be free from defective materials or factory workmanship for a period of 90 days from the date of original customer purchase and provided the product is utilized within the U.S.A. This warranty is not assignable or transferable. Our obligation under this warranty is the repair or replacement of the defective unit or any part thereof, except batteries, when it is returned to the SPECTRA Service Department, accompanied by proof of the date of original consumer purchase, such as a duplicate copy of a sales receipt.

You must pay all shipping charges required to ship the product to SPECTRA for warranty service. If the product is repaired or replaced under warranty, the return charges will be at SPECTRA's expense. There are no other express warranties other than those stated herein.

This warranty is valid only in accordance with the conditions set forth below:

1. The warranty applies to the SPECTRA product only while:
  - a. It remains in the possession of the original purchaser and proof of purchase is demonstrated.
  - b. It has not been subjected to accident, misuse, abuse, improper service, usage outside the descriptions and warnings covered within the user manual or non-SPECTRA approved modifications.
  - c. Claims are made within the warranty period.
2. This warranty does not cover damage or equipment failure caused by electrical wiring not in compliance with electrical codes or SPECTRA user manual specifications, or failure to provide reasonable care and necessary maintenance as outlined in the user manual.
3. Warranty of all SPECTRA products applies to residential use only and is void when products are used in a nonresidential environment or installed outside the United States.

This warranty gives you specific legal rights, and you may also have other rights which vary from state to state. TO OBTAIN SERVICE please remove all batteries (if any) and pack the unit carefully and send it freight prepaid to SPECTRA at the address shown below. IF THE UNIT IS RETURNED WITHIN THE WARRANTY PERIOD shown above, please include a proof of purchase (dated cash register receipt) so that we may establish your eligibility for warranty service and repair of the unit without cost. Also include a note with a description explaining how the unit is defective. A customer service representative may need to contact you regarding the status of your repair, so please include your name, address, phone number and email address to expedite the process.

IF THE UNIT IS OUTSIDE THE WARRANTY PERIOD, please include a check for \$20.00 to cover the cost of repair, handling and return postage. All out of warranty returns must be sent prepaid.

It is recommended that you contact SPECTRA first at 1-800-777-5331 or by email at [custserv@spectraintl.com](mailto:custserv@spectraintl.com) for updated information on the unit requiring service. In some cases the model you have may be discontinued, and SPECTRA reserves the right to offer alternative options for repair or replacement.

SPECTRA MERCHANDISING INTERNATIONAL, INC.

4230 North Normandy Avenue,

Chicago, IL60634, USA.

1-800-777-5331

To register your product, visit the link on the website below to enter your information.

<http://www.spectraintl.com/wform.htm>

0313

Printed in China