

Instructions for use

KitchenAid

Important instructions for safety	4
Installation	6
Safeguarding the environment	6
Troubleshooting guide	7
After-Sales Service	8
Cleaning	8
Maintenance	9
Material supplied	10
Installation - preliminary assembly instructions	11
Installation dimensions	12
Installation - assembly instructions	13
Description and use of hood	14

Important instructions for safety

YOUR SAFETY AND THAT OF OTHERS IS HIGHLY IMPORTANT.

This manual and the appliance itself provide important safety warnings, to be read and observed at all times.

 This is the attention symbol, pertaining to safety, which alerts users to potential risks to themselves and others.

All safety warnings are preceded by the attention symbol and the following terms:

DANGER:

indicates a hazardous situation which, if not avoided, will cause serious injury.

WARNING:

indicates a hazardous situation which, if not avoided, could cause serious injury.

All safety warnings specify the potential danger/warning to which they refer and indicate how to reduce the risk of injury, damage and electrical shock resulting from incorrect use of the appliance. Comply with the following instructions:

- Installation or maintenance must be carried out by a specialized technician, in compliance with the manufacturer's instructions and local safety regulations.
Do not repair or replace any part of the appliance unless specifically requested in the user manual.
- The appliance must be disconnected from the power supply before carrying out any installation work.
- Earthing of the appliance is compulsory. (Not necessary for class II hoods identified by the  symbol on the specifications label).
- The power supply cable must be long enough to permit connecting the appliance to the mains socket outlet.
- Do not pull the power supply cable in order to unplug the appliance.
- The electrical components must no longer be accessible to the user after installation.
- Do not touch the appliance with any wet part of the body and do not operate it when barefoot.
- This appliance may be used by children older than 8 years of age and by persons with reduced physical, sensory or mental capacities or with inadequate experience and knowledge only if they are supervised or if they have been taught how to use the appliance in conditions of safety and if they are aware of the dangers involved. Children must not play with the appliance. Cleaning and maintenance must not be carried out by children, unless they are supervised by adults.
- Do not repair or replace any part of the appliance unless specifically indicated in the manual. Defective parts must be replaced using genuine parts. All other maintenance services must be carried out by a specialized technician.
- Children must be supervised to ensure they do not play with the appliance.
- When drilling through a wall or the ceiling, pay attention not to damage electric connections and/or pipes.
- The ventilation ducts must always discharge to the outside.
- Exhaust air must not be vented through a flue used for removal of fumes produced by appliances burning gas or other fuels, but must have a separate outlet. All national regulations governing extraction of fumes must be observed.
- If the hood is used together with other appliances operating on gas or other fuels, the negative pressure in the room must not exceed 4 Pa (4 x 10⁻⁵ bar).
For this reason, make sure the room is adequately ventilated.
- The Manufacturer declines any liability for improper use or incorrect setting of the controls.
- Regular cleaning and maintenance is essential to correct functioning and good performance of the appliance. Frequently clean all encrustations from dirty surfaces to prevent the accumulation of grease. Regularly clean or replace the filters.
- Failure to observe the instructions for cleaning the hood and replacing the filters may result in a fire.
- The fume extractor hood must never be opened without the grease filters installed and it should be kept under constant supervision.
- Gas appliances must be used under the extractor hood only with pans resting.
- When using more than three gas cooking points, the hood should be operating at power level 2 or greater. This will eliminate heat congestion in the appliance.
- Before touching the bulbs, first ensure that they are cold.
- Do not use or leave the hood without its lamps correctly installed - risk of electric shock.
- Wear work gloves for all installation and maintenance operations.

- The product is not suitable for outdoor use.
- When the hob is in use, accessible parts of the hood may become hot.
- Never flame cook food (flambé) under the appliance. Using free flames might cause fire.
- Do not leave frying pans unattended when frying, as the frying oil may catch fire.

Declaration of conformity

- This appliance has been designed, manufactured and marketed in compliance with:
 - safety objectives of the “Low Voltage” Directive 2006/95/EC (which replaces 73/23/EEC and subsequent amendments);
 - the ecodesign requirements of european regulations n. 65/2014, and n. 66/2014 in conformity to the european standard EN 61591
 - the protection requirements of Directive “EMC” 2004/108/EC.
- Electrical safety of the appliance can only be guaranteed if it is correctly connected to an approved earthing system.

Scrapping of household appliances

- This appliance is manufactured with recyclable or reusable materials. Dispose of it in accordance with local waste disposal regulations. Before disposing of it, make it unusable by cutting off its power supply cable.
- For further information on the treatment, recovery and recycling of household appliances, contact your competent local authority, the collection service for household waste or the shop where you purchased the appliance.

KEEP THESE INSTRUCTIONS

Energy saving tips

- Switch ON the hood at minimum speed when you start cooking and kept it running for few minutes after cooking is finished.
- Increase the speed only in case of large amount of smoke and vapour and use boost speed(s) only in extreme situations.
- Replace the charcoal filter(s) when necessary to maintain a good odour reduction efficiency.
- Clean the grease filter(s) when necessary to maintain a good grease filter efficiency.
- Use the maximum diameter of the ducting system indicated in this manual to optimize efficiency and minimize noise.

Installation

After unpacking the appliance, check for any damage caused during transport. In case of problems, contact the dealer or the After-Sales Service. To avoid any damage, it is advisable to only remove the appliance from the polystyrene base just before installation.

PREPARATION FOR INSTALLATION

WARNING:

this appliance is heavy; the hood should only be lifted and installed by two or more people.

The minimum distance between the cooking pan support on top of the cooker and the bottom of the hood must not be less than 50 cm for electric cookers and 65 cm for gas or mixed cookers.

Before installation also check the minimum distances stated in the manual of the cooker.

If the installation instructions for the cooker specify a greater distance between cooker and hood, this distance must be observed.

ELECTRICAL CONNECTIONS

Make sure the power voltage specified on the appliance rating plate is the same as the mains voltage.

This information may be found on the inside of the hood, under the grease filter.

Power cable replacement (type H05 VV-F 3 x 0.75 mm²) must be carried out by a qualified electrician. Contact an authorized service centre.

If the hood is fitted with an electric plug, connect the plug to a socket complying with current regulations, located in an accessible place. If no plug is fitted (direct wiring to the mains), or if the socket is not located in an accessible place, install a standardized double pole power switch that will enable complete isolation from the mains in case of category III overvoltage conditions, in accordance with wiring rules.

GENERAL RECOMMENDATIONS

Before use

Remove cardboard protection pieces, transparent film and adhesive labels from accessories.

Make sure the appliance has not been damaged during transport.

During use

Do not place weights on the appliance, as they could damage it.

Do not expose the appliance to atmospheric agents.

Safeguarding the environment

Disposal of packing

The packing material is 100% recyclable and is marked with the recycle symbol . The various parts of the packing must be disposed of responsibly and in full compliance with local authority regulations governing waste disposal.

Disposal of the appliance

- This appliance is marked in compliance with European Directive 2002/96/EC on Waste Electrical and Electronic Equipment (WEEE).

- By ensuring that this appliance is disposed of correctly, you can help prevent potentially damaging consequences for the environment and health.
- The  symbol on the product or on the accompanying documentation indicates that it should not be treated as domestic waste but must be taken to an appropriate collection centre for the recycling of electrical and electronic equipment.

Troubleshooting guide

The hood does not work

Make sure:

- There is not a power failure.
- A speed has actually been selected.
- The front panel is correctly hooked.
- The 9-pin connection is properly inserted. (Figure 1)
- The red reset button on the electrical system box is pressed. (Figure 2)
- In the 9-pin connection, make sure the wires are properly inserted in the connector. (When connecting, pressing too hard could bend the contacts). (Figure 3)

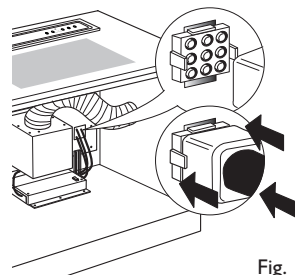

Fig. 1

The hood does not extract sufficiently

Make sure:

- The selected speed is sufficient for the quantity of fumes and steam present.
- There is enough ventilation to allow an air inlet.
- The carbon filter is not worn (Filter version hood).
- The exhaust air outlet pipe is free of obstructions.
- The extraction unit non-return valves are free to rotate. (Figure 4)

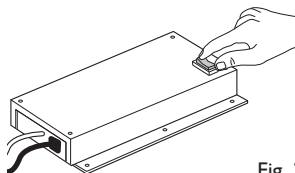

Fig. 2

The hood stops during operation

Make sure:

- There is not a power failure.
- The differential thermal-magnetic switch (safety cutout) has not tripped.

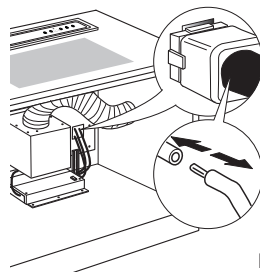

Fig. 3

The lamp does not work

- Check if the lamp needs replacing.
- Make sure the lamp is correctly fitted.

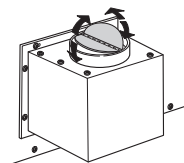

Fig. 4

After-Sales Service

Before calling the After-Sales Service:

1. See if you can solve the problem yourself with the help of the suggestions given in the "Troubleshooting guide".
2. Switch the appliance off and back on again to see if the fault persists.

If after the above checks the fault still occurs, get in touch with the nearest After-Sales Service.

Always specify:

- A brief description of the fault;
- The exact type and model of the appliance;
- The service number (number after the word "Service" on the rating plate), located on the inside of the appliance. The service number is also indicated on the guarantee booklet;

- Your full address;
- Your telephone number.

SERVICE 0000 000 00000



If any repairs are required, please contact an **authorised After-sales Service** (to guarantee that original spare parts will be used and repairs carried out correctly).

Cleaning

WARNING

- Do not use steam cleaners.
- Disconnect the appliance from the power supply.

IMPORTANT: After carrying out hood or filter cleaning, refit the front panel and filters, checking correct installation and hooking, otherwise the hood will not switch on.

IMPORTANT: Do not use corrosive or abrasive detergents. If any of these products accidentally comes into contact with the appliance, clean it immediately with a damp cloth.

- Clean the surfaces with a damp cloth. If very dirty, add a few drops of washing up detergent to the water. Dry with a dry cloth.

IMPORTANT: Do not use abrasive sponges, metallic scrapers or scouring pads, as they could eventually spoil the enamelled surfaces.

- Use specific detergents for cleaning the appliance and follow the manufacturer's instructions.

IMPORTANT: Clean the filters at least monthly to remove any oil or grease residuals.

IMPORTANT: Failure to carry out correct hood cleaning or filter maintenance involves the risk of fire. Therefore make sure to follow the instructions.

The manufacturer declines any liability for damage to the extraction unit, fires caused by improper maintenance or failure to observe the above instructions.

Maintenance

WARNING

- Use protective gloves.
- Disconnect the appliance from the power supply.

IMPORTANT: After carrying out hood or filter cleaning, refit the front panel and filters, checking correct installation and hooking, otherwise the hood will not switch on.

GREASE FILTER

Its purpose is to retain the particles of grease produced by cooking.

It must be cleaned once a month (or when the filter saturation warning system indicates this need) with non-aggressive detergents, by hand or in a dishwasher at low temperature and with short cycle.

Cleaning in a dishwasher may cause discolouring of the metallic grease filter, but its filtering efficiency is unaffected.

Grease and carbon filters must be fitted and removed while the air intake panel of the hood is open.

To carry out this procedure, press ON (T5). Remove the front panel by pulling the top part of each side at the same time. The panel will flip forwards, providing access to the grease filters (Figure 5)

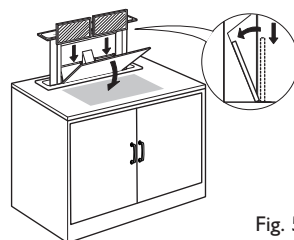

Fig. 5

ACTIVATED CARBON FILTER (Filter Version only)

Its purpose is to retain the unpleasant odours produced by cooking.

The carbon filter becomes saturated after more or less prolonged use depending on the type of cooker and how often the grease filter is cleaned. In any case the carbon filter must be replaced at least every four months.

The carbon filter CANNOT be washed or regenerated.

The carbon filters can be inserted after removing the grease filters. (Figure 6)

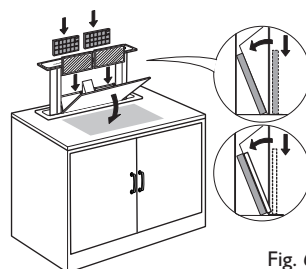

Fig. 6

LIGHTING SYSTEM

WARNING

Disconnect the appliance from the power supply.

IMPORTANT: Do not touch the neon with bare hands after prolonged hood use with the lights switched on.

To replace the neon, proceed as follows (Figure 7):

1. Lift the extraction panel.
2. Disconnect the power supply (this operation can be carried out by pulling out the plug, if accessible, or opening the switch, if provided for during installation, or pressing the red reset button in the control box).
3. Remove the screws fixing the upper front.
4. Lift the upper front
5. Remove the burnt-out neon and replace it with one having the same characteristics (Model T5 14W 860).

If the lighting does not work, make sure the neon is properly fitted before calling the After-Sales Service.

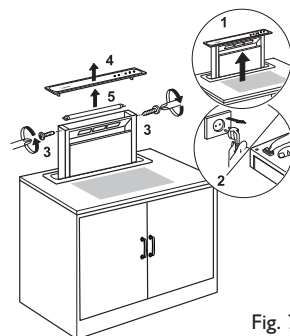

Fig. 7

Material supplied

Remove all the components from the packets. Check that all the components are included. (Figure 8)

- Hood assembled with extraction unit, neon and grease filters installed
- 2 Carbon filters
- Instructions for assembly and use
- Metal box containing the electronic components.
- 2 Brackets
- 2 Screws $\text{\O} 3,5 \times 9,5$
- 4 Screws $\text{\O} M4 \times 10$
- 2 Washers

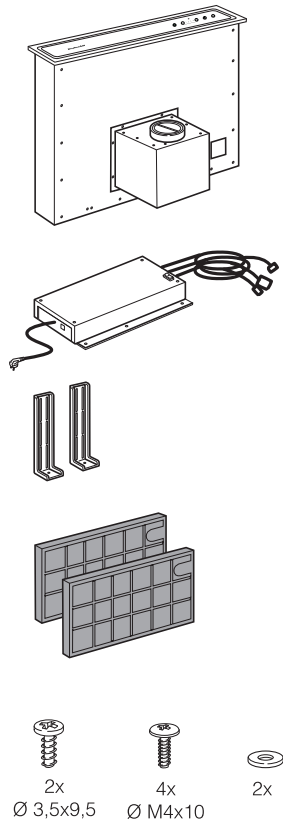

Fig. 8

Installation - preliminary assembly instructions

The hood is designed for installation and use in "Extractor Version" with extraction to the outside or in "Filter Version" with internal recirculation.

Install the hood away from very dirty areas, windows, doors and heat sources.

IMPORTANT: Before connecting the air outlet flexible tube, make sure the extraction unit non-return valves are free to rotate. (Figure 9)

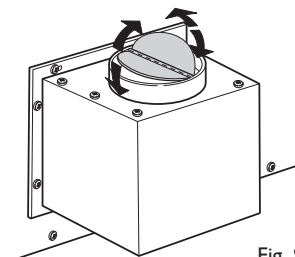

Fig. 9

Extractor Version (Figure 10)

Steam and fumes are expelled to the outside through an exhaust pipe fixed to the connection flange.

The diameter of the exhaust must be equal to that of the connection collar (150 mm).

In the horizontal part, the pipe must slope slightly upwards (approx. 10°) to convey the air to the outside more easily.

IMPORTANT: The extraction pipe is not supplied and must be purchased.

IMPORTANT: If already installed, remove the carbon filters.

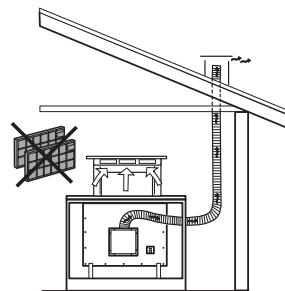

Fig. 10

Filter Version (Figure 11)

The sucked air will be degreased and deodorised before being re-conveyed in the room. To use the hood in this version it is necessary to install an additional filtering system based on activated carbons.

IMPORTANT: The air recycled through the carbon filters is sent through a duct that conveys the air on one side of the cabinet.

IMPORTANT: Check that air recirculation is facilitated..

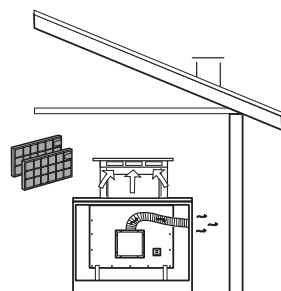

Fig. 11

Installation - assembly instructions

The instructions given below in numerical order refer to the drawings in the "assembly instructions" manual, containing the respective numbering.

1. Make a 842x100 mm rectangular hole behind the hob, to enable insertion of the hood.

IMPORTANT: Make sure the overall dimensions of the hood and hob are compatible with the cabinet and therefore that installation is feasible.

Maintain a minimum distance of 70 mm from the hob.

Before making the hole, make sure the structure of the cabinet or other parts that could create problems for correct installation are not present in the hood zone inside the cabinet.

2. Remove the extraction unit from the main body of the hood by undoing the 8 fixing screws.
3. Install the hood in the hole, inserting it from above.
4. Fix the 2 brackets (supplied) to the main hood body. Undo the 4 ØM4x10 screws already fitted on the hood and fix the brackets.

IMPORTANT: Position the brackets so that a distance of 2 mm remains between the lower part of the brackets and the bottom of the cabinet. This distance allows the hood to be pulled downwards at the time of fixing, to ensure perfect adherence of the stainless steel frame to the worktop.

5. Fix the hood inside the cabinet, operating on the 2 brackets, using the 2 washers and 2 Ø3.5x9.5 screws supplied.

IMPORTANT: Before fitting the screws in the cabinet, make sure the product is perfectly perpendicular to the worktop.

6. Fit the extraction unit, adjusting the air outlet to the required position upwards or downwards.
7. Make a 150 mm diameter hole in the cabinet for the air outlet ducting.

IMPORTANT: Locate the best position according to the particular conformation.

8. Fit the air outlet ducting.

IMPORTANT: The extraction pipe is not supplied and must be purchased.

Avoid drastic changes of direction.

Use a pipe in approved material and having a constant width of 150 mm for its entire length.

9. Connect the electrical connectors of the metal box to the hood (pushbutton panel connector, 9-pin connector, neon connector) and the extraction unit to the metal box (6-pin connector).
10. Position the metal box containing the electronic components so as not to hinder the air outlet ducting.
11. Connect the hood to the power supply and press the red reset button on the metal box.
12. Press the ON button (T5) on the control panel to open the extraction panel, remove the hood protection devices and lock the door.

Description and use of hood

(Figure 13)

1. Control panel
2. Front panel
3. Grease filters
4. Carbon filters (Filter Version only)
5. Lighting

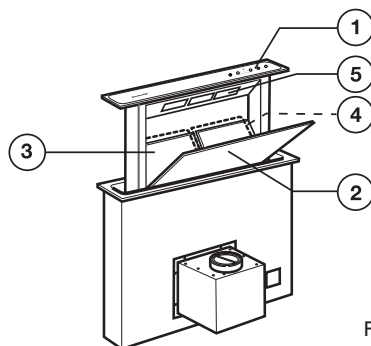

Fig. 13

CONTROL PANEL (Figure 14)

The hood has a "TOUCH" device for control of lights and speed. For correct use, carefully read the instructions below.

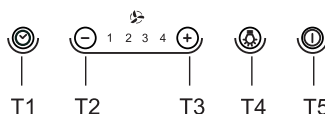

Fig. 14

- **Button T1:**

Delays hood switch-off, timing the set speed for a few minutes.

With this function, the hood switches off at the end of the time.

Operation times are as follows:

- extraction speed (power) 1: 20 minutes.
- extraction speed (power) 2: 15 minutes.
- extraction speed (power) 3: 10 minutes.
- extraction speed (power) 4: 5 minutes.

Press button **T2** or **T3** and the hood exits timed mode and the extraction speed (power) decreases or increases depending on the button pressed. During the timing stage, the LED corresponding to the speed blinks.

IMPORTANT: When operating the timer, the hood might switch to a lower intake speed (power) before turning off, as on some speeds there is already a timing on the speed reduction itself.

- **Button T2:**

Decreases the active extraction speed (power) (4→3→2→1→OFF). The speed is displayed by lighting up of the LED corresponding to the speed. Button T2 has no effect on extraction panel opening/closing.

- **Button T3:**

Increases the active extraction speed (power) (1→2→3→4). The speed is displayed by lighting up of the LED corresponding to the speed.

IMPORTANT: (only for models fitted with a motor or a remote GME 22):

Suction speed 4 (power) is timed for 6 minutes, after which the hood will automatically switch to suction speed 3 (power).

IMPORTANT: If the panel is closed (hood off), button **T3** firstly operates extraction panel opening and then sets the hood to extraction speed (power) 1.

- **Button T4:**

Switches on the light.

IMPORTANT: If the extraction panel is closed (hood off), button **T4** firstly operates extraction panel opening and then switches on the light.

- **Button T5:**

Opens (lifts) and closes (lowers) the extraction panel.

With the hood off and panel closed, button **T5** firstly opens the extraction panel and then sets the hood to extraction speed (power) 1.

With the hood on (at any speed) and panel open, button **T5** firstly switches the hood off (also switching off the lights, if on) and then closes the extraction panel.

IMPORTANT: Use the highest speed setting for particularly concentrated steam and fumes. It is advisable to activate extraction 5 minutes before starting cooking and leave it on for about another 15 minutes at the end of cooking.

Additional information on operation

When removing the front panel for cleaning and maintenance operations, all electronic extraction and movement functions are blocked.

Antipinching system: whenever an obstacle hinders closing of the Downdraft, closing stops and the extraction panel goes up.

Grease filter saturation signalling

Every 40 hours of use, the hood signals the need for grease filter maintenance. Signalling occurs with all the extraction speed (power) LEDs blinking at the same time.

Grease filter signalling reset: after carrying out grease filter maintenance, press button **TI** for more than 3 seconds to reset the signalling.

IMPORTANT: Signalling is not displayed with the hood OFF, regardless of the position of the extraction panel.



FOR THE WAY IT'S MADE.

Printed in Italy

04/15

400010790008

