

































Operating and installation instructions Wine conditioning unit



To avoid the risk of accidents or damage to the appliance, it is **essential** to read these instructions before it is installed and used for the first time.

Contents

Warning and Safety instructions	5
Sustainability and environmental protection	13
Caring for the environment	13
How to save energy	14
Familiarising yourself with the appliance	15
Guide to the appliance	15
Display	16
Settings mode 	17
Feature lighting 	17
Lock function  / 	17
Switching off the wine conditioning unit 	17
Sabbath mode 	17
Information on Sabbath mode i	17
Time before door alarm  is triggered	17
Miele@home 	17
Keypad tone  / 	18
Alarms and buzzers  / 	18
Display brightness 	18
Temperature unit °C/°F	18
Demo mode 	18
Factory default settings 	18
Information on the wine conditioning unit i	18
Active AirClean filter display 	19
Accessories supplied	19
Safety	19
Temperature alarm	19
Switching the temperature alarm off early	19
Door alarm	20
Adjusting the interior fittings	20
Removing and reinserting the wooden shelves	20
Adjusting the wooden shelf (FlexiFrame) to the bottle size	21
Maximum capacity	21
Writing on the labelling strip (NoteBoard)	21
Commissioning	23
Before using for the first time	23
Connecting the wine conditioning unit	23
Activating the charcoal filter (Active AirClean filter) 	23
Positioning the slats on the wooden shelves	23
Setting up the stacking aid	23
Switching on the wine conditioning unit	24
Switching off the wine conditioning unit	24
Switching off for longer periods of time	24

Operation	25
Setting the temperature	25
Temperature range.....	25
Temperature display	25
Setting the humidity (ActiveHumidity) in the lower wine conditioning zone 	25
Humidity range.....	25
Adjusting settings	27
Explanation of the different settings.....	27
Setting the brightness of the feature lighting 	27
Switching the lock function  /  on.....	27
Switching Sabbath mode  on	27
Switching Sabbath mode  off.....	28
Changing the time before the door alarm  is triggered	28
Setting up Miele@home for the first time	28
Deactivating the Wi-Fi connection	28
Activating the Wi-Fi connection	28
Switching off the keypad tone 	29
Switching on the keypad tone 	29
Changing the volume of the alarms and buzzers  / 	29
Changing the display brightness 	29
Changing the temperature unit °C/°F.....	30
Switching off demo mode 	30
Resetting the settings to their factory default settings 	30
Activating the Active AirClean filter display 	30
Cleaning and care	31
Cleaning agents	31
Preparing the wine conditioning unit for cleaning	31
Cleaning the interior of the appliance	31
Replacing the Active AirClean filter	32
Cleaning the door seal.....	33
Cleaning the ventilation gaps	33
After cleaning.....	33
Automatic defrosting.....	33
Problem solving guide	34
Service	39
Contact in case of fault.....	39
Warranty	39
Optional accessories	40

Contents

Installation	41
Installation site	41
Climate range	42
Ventilation.....	42
Side-by-side units	42
Changing the door hinging	43
Installation dimensions	44
Niche/side view	44
Connections	45
Installing the wine conditioning unit.....	46
To install the wine conditioning unit, you will need the following tools:.....	46
Preparing the wine conditioning unit	46
Pushing in the wine conditioning unit.....	46
Aligning the wine conditioning unit	47
Aligning the wine conditioning unit to taller furniture doors	49
Securing the wine conditioning unit in the niche	50
Electrical connection	51



Warning and Safety instructions

This wine conditioning unit complies with all current local and national safety requirements. However, inappropriate use can lead to personal injury and damage to property.

Read the operating and installation instructions carefully before using the wine conditioning unit. They contain important information on installation, safety, use and maintenance. This is to protect yourself from injury, and from damaging your wine conditioning unit.

In accordance with standard IEC 60335-1, Miele expressly and strongly advises that you read and follow the instructions in “Installation”, as well as in the “Warning and safety instructions”.

Miele cannot be held liable for injury or damage caused by non-compliance with these instructions.

Keep these instructions in a safe place and pass them on to any future owner.

 Risk of injury from broken glass.

If installed at altitudes above 1500 m, there is a risk of the glass in the appliance door breaking because of changes in air pressure. Shards of glass can cause severe injury.

Correct application

► This appliance is designed for domestic use and for use in similar environments by guests in hotel or motel rooms, bed & breakfasts and other typical living quarters. This does not include common/shared facilities or commercial facilities within hotels, motels or bed & breakfasts. This wine conditioning unit is not suitable for outdoor use.

► The wine conditioning unit is intended exclusively for domestic use for storing wine.

The wine conditioning unit is not suitable for freezing food.

The wine conditioning unit is suitable for integrated underbench installation.

Any other usage is not permitted.

Warning and Safety instructions

▶ This wine conditioning unit is not suitable for storing and keeping cool medicines, blood plasma, laboratory preparations or similar substances or products. Incorrect use of the wine conditioning unit for such purposes may cause deterioration of the items stored. The wine conditioning unit is also not suitable for use in areas where there is a risk of explosion.

Miele cannot be held liable for damage resulting from incorrect or improper use or operation of the appliance.

▶ This appliance is not intended for use by persons (including children) with reduced physical, sensory or mental capabilities or lack of experience and knowledge, unless they have been given supervision and instruction concerning its use by a person responsible for their safety.

They may only use the appliance unsupervised if its operation has been clearly explained to them and they are able to use it safely and are able to understand and recognise the possible dangers caused by incorrect operation.

Safety with children

▶ Young children must not be allowed to use this appliance.

▶ Older children may only use the wine conditioning unit if its operation has been clearly explained to them and they are able to use it safely. They must be able to understand and recognise the possible dangers of misuse.

▶ Cleaning work may only be carried out by older children under the supervision of an adult.

▶ Children should be supervised in the vicinity of the wine conditioning unit. Never allow children to play with the wine conditioning unit.

▶ Danger of suffocation! Children may be able to wrap themselves in packing material (e.g. foil) or pull it over their head with the risk of suffocation. Keep packaging material away from children.

Technical safety

▶ The refrigerant circuit has been checked for leaks. The wine conditioning unit complies with all current local and national safety requirements.



► Warning: fire hazard/flammable materials. This symbol is on the compressor and indicates flammable materials. Do not remove this sticker.

The refrigerant inside the appliance (details on the data plate) is environmentally friendly but flammable.

The use of this refrigerant does, however, sometimes lead to a slight increase in the noise level of the appliance. In addition to the noise of the compressor, you might be able to hear the refrigerant flowing around the system. Unfortunately, this cannot be avoided, but it does not affect the performance of the wine conditioning unit.

When transporting and installing the wine conditioning unit, ensure that no parts of the cooling circuit are damaged. Splashes of refrigerant can damage the eyes and leaking refrigerant can ignite. In the event of any damage:

- Avoid naked flames or anything which creates a spark.
- Disconnect the wine conditioning unit from the mains electricity supply.
- Ventilate the room in which the wine conditioning unit is located for several minutes.
- Call Miele.

► The more coolant there is in a wine conditioning unit, the larger the room should be in which it is installed. In the event of a leakage, if the appliance is in a small room, there is the danger of a combustible gas/air mixture building up. For every 8 g of coolant, at least 1 m³ of room space is required. The amount of coolant in the wine conditioning unit is stated on the data plate inside the appliance.

► Ensure that the connection data on the wine conditioning unit's data plate (fuse rating, frequency and voltage) match the electricity supply to prevent damage to the wine conditioning unit. Compare this before connecting the appliance to the mains electricity.

If in any doubt, consult a qualified electrician.

Warning and Safety instructions

- ▶ The electrical safety of this wine conditioning unit can only be guaranteed when continuity is complete between it and an effective earthing system. It is most important that this basic safety requirement is present.
If in doubt, the electrical installation should be checked by a qualified electrician.
- ▶ Temporary or permanent operation with a self-sufficient or non-mains synchronous energy supply system (e.g. isolated networks, back-up systems) is possible. A requirement for the operation is that the energy supply system complies with all current local and national requirements that apply to stand-alone, solar and/or battery systems. The protective measures provided in the installation and in this Miele product must also be assured in their function and operation in isolated operation or in non-mains synchronous operation, or replaced with equivalent measures in the installation.
- ▶ If the electrical connection cable supplied is damaged, it must only be replaced by an original spare part to prevent a hazard for the user. Miele can only guarantee the safety of the appliance when original Miele parts are used. For safety reasons, replacement may only be carried out by a suitably qualified specialist or Miele Customer Service.
- ▶ Multi-socket adapters and extension leads do not guarantee the required safety of the appliance (e.g. danger of overheating). Do not use these to connect the wine conditioning unit to the mains electricity supply.
- ▶ If moisture gets into electrical components or into the mains connection cable, it could cause a short circuit. Therefore, do not operate this wine conditioning unit in areas which are exposed to moisture (e.g. in a garage or utility room).
- ▶ This wine conditioning unit must not be installed and operated in mobile installations (e.g. on a ship).
- ▶ Damage to the wine conditioning unit can compromise your safety. Before using the wine conditioning unit, check it for any visible damage. Never use a damaged wine conditioning unit.
- ▶ For safety reasons, this wine conditioning unit may only be used when it has been built in.

Warning and Safety instructions

- ▶ During installation, maintenance and repair work, the wine conditioning unit must be completely disconnected from the mains electricity supply. It is only completely isolated from the electricity supply when:
 - the mains circuit breaker is switched off, or
 - the screw-out fuse is removed (in countries where this is applicable), or
 - it is switched off at the wall socket and the plug is withdrawn from the socket, or it is switched off at the isolator. Pull on the plug and not the cable when disconnecting it from the power supply.
- ▶ Repairs and other work by unqualified persons could be dangerous. Installation must be performed by a suitably qualified and competent person. Maintenance and repairs must only be carried out by a Miele authorised technician.
- ▶ The manufacturer's warranty will be invalidated if the appliance is not repaired by a Miele approved service technician.
- ▶ Faulty components must only be replaced with genuine Miele original spare parts. Miele can only guarantee the safety standards of the appliance when Miele spare parts are used.
- ▶ This wine conditioning unit is supplied with a special lamp to cope with particular conditions (e.g. temperature, moisture, chemical resistance, abrasion resistance and vibration). This lamp must only be used for the purpose for which it is intended. The lamp is not suitable for room lighting. Replacement lamps may only be fitted by an authorised technician or Miele Customer Service. This wine conditioning unit contains several light sources with at least energy efficiency class G.
- ▶ In areas which may be subject to infestation by cockroaches or other vermin, pay particular attention to keeping the appliance and its surroundings clean at all times. Any damage caused by cockroaches or other vermin will not be covered by the warranty.

Correct installation

- ▶ When installing the refrigeration appliance, it is a mandatory requirement to follow the installation instructions supplied with it.
- ▶ Always wear protective gloves when transporting and installing the wine conditioning unit.
- ▶ Two people are required to install the wine conditioning unit.

Warning and Safety instructions

▶ Change the door hinging (if necessary) as described in the installation instructions supplied with the appliance.

Correct use

▶ This wine conditioning unit is designed for use within specific ambient temperatures (climate range). Do not use it in ambient temperatures for which it is not designed. The climate range is stated on the data plate inside the wine conditioning unit. A lower ambient temperature will cause the compressor to switch off for longer periods, meaning that the wine conditioning unit is unable to maintain the required temperature in some circumstances.

▶ To ensure proper air flow in and out of the appliance, the ventilation gaps in the appliance and built-in structure must not be covered or blocked in any way. This would also increase the energy consumption and could cause damage to the appliance.

▶ If the wine conditioning unit is used for storing food which contains fat or oil, make sure that it does not come into contact with plastic components. Any spillages of oil or fat could cause stress cracks to the plastic and cause it to break or split.

▶ Risk of fire and explosion! Do not store explosive materials in the wine conditioning unit or any products containing propellants (e.g. spray cans). Electrical components can cause flammable mixes of gases to ignite.

▶ Danger of explosion! Do not operate any electrical appliances inside the wine conditioning unit. Danger of sparking and explosion.

Accessories and spare parts

▶ Only use original Miele accessories. Using spare parts or accessories from other manufacturers will invalidate the warranty, and Miele cannot accept liability.

▶ Miele will guarantee to supply functional spare parts for a minimum of 10 years and up to 15 years following the discontinuation of your wine unit.

Cleaning and care

▶ Do not use any oils or grease on the door seals, as these will cause the seals to deteriorate and become porous with time.

Warning and Safety instructions

▶ The steam from a steam cleaning appliance could reach electrical components and cause a short circuit.

Do not use a steam cleaning appliance to clean this appliance.

▶ **Warning:** Do not use any mechanical tools or other types of aid which are not recommended by the manufacturer to accelerate the defrosting process.

▶ Sharp edged objects will damage the evaporator, causing irreversible damage to the wine conditioning unit. Therefore, do not use sharp objects to:

- remove layers of ice.
- remove label residues, for example.

Transport

▶ Always transport the wine conditioning unit upright and in its packaging to avoid it being damaged.

▶ Risk of injury and damage! The wine conditioning unit is very heavy and must be transported by two people.

Disposal of your old appliance

▶ Children playing could become trapped in the wine conditioning unit and could suffocate.

- Remove the appliance door.
- Leave the wooden/metal shelves in the wine conditioning unit so children cannot climb inside.
- If the wine conditioning unit has a door lock, make sure that children cannot lock themselves inside while playing as this could endanger their lives.

▶ Risk of electric shock!

- Cut the electrical plug off the power supply cord.
- Cut the power supply cord off the old appliance.

Dispose of the electrical plug and power supply cord separately from the old appliance.

▶ During and after disposal, make sure that the wine conditioning unit is not placed near petrol or other flammable gases and liquids.

Warning and Safety instructions

▶ Risk of fire due to escaping oil or refrigerant!

The refrigerant and oil inside the appliance are flammable. In high enough concentrations, escaping refrigerant or oil may ignite if they come into contact with an external heat source.

During disposal, make sure that the cooling circuit is not damaged in order to prevent refrigerant and oil escaping in an uncontrolled manner (see the data plate for details of the refrigerant).

▶ Splashes of coolant can damage the eyes. Be careful not to damage any part of the pipework whilst awaiting disposal, e.g. by

- puncturing the refrigerant channels in the condenser,
- bending any pipework, or
- scratching the surface coating.

Symbol on the compressor (depending on model)

This information is only relevant for recycling. There is no risk during normal operation.



▶ The oil in the compressor can be fatal if swallowed or if it penetrates the airways.

Caring for the environment

Disposal of the packing material

The transport and protective packaging has been selected from materials which are environmentally friendly for disposal, and can normally be recycled.

Recycling the packaging reduces the use of raw materials in the manufacturing process and also reduces the amount of waste in landfill sites.

Ensure that any plastic wrappings, bags etc. are disposed of safely and kept out of the reach of babies and young children. Danger of suffocation.

Only for Australia: Note for installer: Expanded polystyrene (EPS) packaging included. Please retain and dispose of EPS packaging responsibly. For further information, please contact Miele.

Disposing of your old appliance

Electrical and electronic appliances contain many valuable materials. They also contain certain materials, compounds, and components which were essential for their correct functioning and safety. These could be hazardous to human health and to the environment if disposed of with general waste or if handled incorrectly. Please do not, therefore, dispose of your old appliance with your household waste.



Take care not to damage your refrigeration appliance before or during disposal in an authorised, environmentally friendly manner. This is to ensure that refrigerant in the cooling circuit and oil in the compressor is contained, and will not leak into the environment.

Please dispose of it at your local community waste collection/recycling centre for electrical and electronic appliances, or contact Miele. You are also responsible for deleting any personal data that may be stored on the appliance prior to disposal. You should remove any old batteries which are not securely enclosed by the appliance and remove any lamps without destroying them, where this is possible. These must be taken to a suitable collection point where they can be handed in free of charge. Please ensure that your old appliance presents no danger to children while being stored awaiting disposal.

Sustainability and environmental protection

How to save energy ...

- Installation site** The wine conditioning unit has to cool more often at higher ambient temperatures and consumes more energy in the process. Therefore, you should:
- Install the wine conditioning unit in a well-ventilated room.
 - Do not install the wine conditioning unit near to a heat source (heater element, cooker).
 - Protect the wine conditioning unit from direct sunlight.
 - Ensure an ideal ambient temperature of 20 °C.
 - Clean the ventilation openings on a regular basis to remove any dust.
- Temperature setting** The colder the temperature, the higher the energy consumption. The following settings are recommended:
- +12 to +14 °C.
- Use** Energy consumption is increased by heat input and impeded air circulation. Therefore, you should:
- only open the appliance door when necessary and for as short a time as possible arrange the wine bottles in a way that makes them easy to find in the appliance
 - always close the appliance door properly after opening it
 - keep wooden shelves arranged as they were when the appliance was delivered
 - avoid overfilling the wooden shelves to allow air to circulate
 - keep the fan air ducts in the wine conditioning unit clear

Familiarising yourself with the appliance

Guide to the appliance

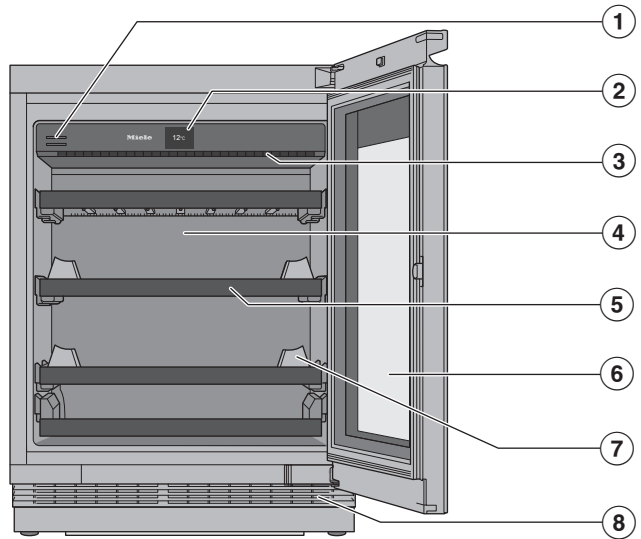



- ① Charcoal filter (Active AirClean filter)
- ② Display
- ③ Interior lighting and feature lighting :
Thanks to the use of LEDs, the wine will not be adversely affected by heat or UV light.
- ④ Dry rear wall for preventing the formation of condensation
- ⑤ Wooden shelves with labelling strips (NoteBoards)
- ⑥ Glass door: the safety glass door with UV filter protects your wine from harmful UV rays.
- ⑦ Stacking aid for optimised bottle storage
- ⑧ Ventilation grille

Familiarising yourself with the appliance

Display

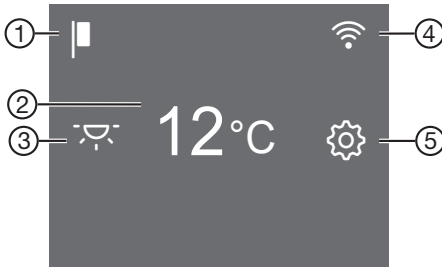
The display can be scratched by pointed or sharp objects, e.g. pens.
Only touch the display with your fingertips.
It is possible that the display will not react to finger contact if your fingers are cold.



- ① Demo mode display
(only visible when the Demo mode function has been switched on)
- ② Temperature display sensor control for setting the temperature
- ③ Feature lighting sensor control 
For switching the interior lighting on and off when the appliance door is closed
- ④ Display for Miele@home connection status
(only visible when the Miele@home function has been set up)
- ⑤ Settings mode sensor 
For adjusting various functions in Settings mode

Operating the wine conditioning unit via the display



- Touch the area/symbol you want on the touch display.
- Swipe left or right across the display until the value/symbol you want is shown in the middle.
- Tap on the option you want in the display to confirm.
The selected value/symbol will light up orange (except for a few exceptions).
- To leave the Settings level, tap on  or *OK*.

Familiarising yourself with the appliance

Settings mode

Feature lighting

The interior lighting can be set to remain on when the appliance door is closed so your wines can be on display at all times.

The feature lighting is switched on and off using the  sensor control in the display. When the feature lighting is switched on, the  sensor control lights up orange.

The feature lighting can be set at different brightness levels or switched off completely (see “Adjusting settings”).

Lock function /

When the lock function is switched on, it protects the wine conditioning unit from being switched off unintentionally and being adjusted unintentionally by unauthorised persons, e.g. children.

If you just want to adjust the temperature quickly, for example, you can deactivate the lock function temporarily (see “Adjusting settings”).

Switching off the wine conditioning unit

You can switch off the wine conditioning unit here (see “Commissioning – Switching the wine conditioning unit off”).

Sabbath mode

The wine conditioning unit offers a Sabbath mode for the purposes of religious observance (see “Adjusting settings”).

When Sabbath mode is switched on, the following are deactivated temporarily:

- the interior lighting when the appliance door is opened
- feature lighting when the appliance door is closed
- the display
- all audible and visual signals
- an active Wi-Fi connection
- reminders (e.g. Active AirClean filter display): the set time interval is paused

All other functions switched on previously remain activated.

When Sabbath mode is switched on, you cannot adjust any settings on your wine conditioning unit.

Information on Sabbath mode

You can call up the Sabbath mode version here.

Time before door alarm is triggered

You can set the time before the appliance door alarm is triggered here (see “Adjusting settings”).

Miele@home

Your wine conditioning unit is equipped with an integrated Wi-Fi module.

Networking is deactivated at the factory.

Here you can set up the Miele@home function for the first time, deactivate and activate the Wi-Fi or reset the network configuration (see “Adjusting settings”).

To use this feature, you will need:

- a Wi-Fi network
- the Miele App

Familiarising yourself with the appliance

- a Miele user account. You can create a user account via the Miele App.

The Miele App will guide you as you connect your wine conditioning unit to your home Wi-Fi network.

Once your wine conditioning unit is connected to your Wi-Fi network, you can use the App to carry out the following activities, for example:

- Call up information on the operating status of your wine conditioning unit
- Change the settings on your wine conditioning unit

Connecting your wine conditioning unit to your Wi-Fi network will increase energy consumption, even when the wine conditioning unit is switched off.

Make sure that the signal of your Wi-Fi network is sufficiently strong in the place where you want to set up your wine conditioning unit.

Keypad tone

You can switch the keypad tone on or off here (see “Adjusting settings”).

Alarms and buzzers

You can change the volume of the alarms and buzzers (e.g. in the event of a door alarm or a fault message) here. Alternatively, you can switch the alarms and buzzers off completely if you find them annoying (see “Adjusting settings”).

Display brightness

You can adjust the display brightness to the lighting conditions in the room here (see “Adjusting settings”).

Temperature unit °C/°F

You can set the required temperature unit (°Celsius or °Fahrenheit) here (see “Adjusting settings”).

Demo mode

You can switch off demo mode here if it has been switched on as a default setting ( will appear in the display) (see “Adjusting settings”).

Demo mode allows the wine conditioning unit to be presented in the showroom without the cooling system being switched on. Do not activate this setting for domestic use.

Factory default settings

You can reset the wine conditioning unit's settings to their factory default settings here (see “Adjusting settings”).

Useful tip: Reset the settings to the factory default settings when disposing of your wine conditioning unit, selling it or putting a used wine conditioning unit into operation. This will reset the network configuration so that your personal data is deleted from the wine conditioning unit. This will also ensure that a previous owner is no longer able to access the wine conditioning unit.

Information on the wine conditioning unit

You can call up the model identifier and serial number of your wine conditioning unit here.

Keep this appliance data to hand:

- for integrating the wine conditioning unit into your Wi-Fi network (see “Adjusting settings – Setting up Miele@home for the first time”)

Familiarising yourself with the appliance

- when reporting an appliance fault to Miele Customer Service (see “Service”)

Active AirClean filter display

Filtering the air through the Active AirClean filter ensures that the air remains free from dust and odours.

The Active AirClean filter display  will remind you approx. every 12 months that the Active AirClean filter has to be replaced (see “Cleaning and care – Replacing the Active AirClean filter (active charcoal filter)”).

You can activate the Active AirClean filter display  here (see “Adjusting settings”).

Accessories supplied

Charcoal filter (Active AirClean filter)

The Active AirClean filter ensures optimum air quality in the wine conditioning unit by filtering the incoming air.

Chalk pen

Use the chalk pen supplied to label the NoteBoards on the wooden shelves. By labelling the NoteBoards you will have a good overview of the types of wine being stored.

Safety

Temperature alarm

The wine conditioning unit is equipped with a temperature alarm so that the temperature cannot rise or fall unnoticed and therefore damage the wine.

If the temperature becomes too warm or too cold,  will light up red in the temperature display. An alarm will also sound until the cause of the alarm is rectified or the alarm is switched off.

The set temperature determines when the appliance recognises a temperature as being too warm or too cold.

The audible and visual signals may be activated in the following situations:

- Too much warm ambient air enters the wine conditioning unit when you are rearranging or taking out wine bottles.
- You are storing a large number of wine bottles.
- There was a power cut.
- There is a fault with the wine conditioning unit.

Switching the temperature alarm off early

Before you switch the temperature alarm off, you must determine the cause and rectify it.

You can switch the alarm off early if you wish.

■ Tap .

 goes out and the alarm will stop.



The warmest temperature recorded in the wine conditioning zone will flash for about 1 minute in the temperature display. Then the temperature display will change to the current temperature in the wine conditioning zone.

Familiarising yourself with the appliance

Door alarm

The wine conditioning unit is fitted with a door alarm to avoid increased energy consumption if the door is left open and prevent the stored wine bottles being affected by temperature fluctuations.

If the appliance door is left open for a longer period of time,  will light up yellow in the display. An alarm will also sound and the interior lighting will flash.

The amount of time until the door alarm is triggered can be changed (see “Adjusting settings – Changing the time before the door alarm  is triggered”). The door alarm’s audible signal can also be switched off (see “Adjusting settings – Changing the volume of the alarms and buzzers ”).

The alarm will stop and  will go out in the display as soon as the appliance door is closed.

Switching the door alarm off early

■ Tap .

The alarm will stop,  will go out and the interior lighting will light up constantly.

If the appliance door is not closed, the door alarm will sound again after a short time.

Adjusting the interior fittings

Removing and reinserting the wooden shelves

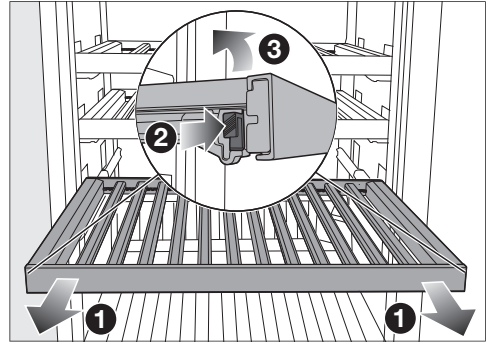

- Pull the wooden shelf out until it stops **1**.
- Press in the latches **2** on both sides of the wooden shelf and lift the wooden shelf upwards **3**.
- To reinsert the wooden shelf, first place it on the rear of the extended rails so that it clicks into place.
- Press the front section of the wooden shelf down onto the extended rails so that the latches click into place.

 Risk of injury from falling wine bottles.

Wine bottles may become wedged in the wooden shelves above and fall out of the wine conditioning unit/refrigeration appliance when the shelves are pulled out.

Always pull out the wooden shelves slowly and carefully.

Familiarising yourself with the appliance

 Risk of damage and injury from broken glass.

If wooden shelves and bottles protrude too far forwards, they may damage the glass door when it is closed.

Please ensure that the wooden shelves and wine bottles do not protrude.

Adjusting the wooden shelf (FlexiFrame) to the bottle size



- You can remove or move individual wooden slats on the wooden shelf as required.

This makes it easy to adjust the wooden shelf to suit the size of your wine bottles.

The slats in the bottom shelf cannot be adjusted.

Maximum capacity

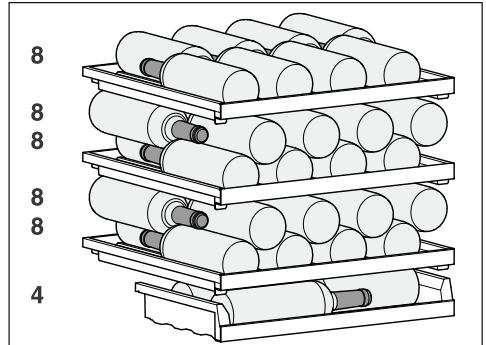

A maximum of 44 Bordeaux-style bottles (0.75 l) can be stored.

 Risk of damage due to overloading.

Exceeding the maximum recommended capacity can lead to damage to the wooden shelves.

Do not exceed the maximum load-bearing capacity of 25 kg for each wooden shelf.

Do not stack bottles on the wooden shelves in more than two layers.

Writing on the labelling strip (NoteBoard)

For quick and easy identification of the wines stored, you can write on the NoteBoards on the wooden shelves.

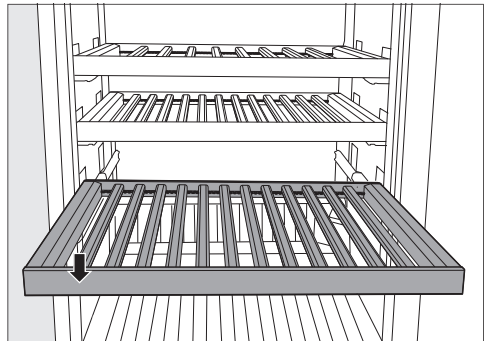

Familiarising yourself with the appliance

- Pull the wooden shelf out a little towards the front.
- The labelling strip can be wiped clean with a damp cloth.

 Risk of damage from unsuitable cleaning agents.

Cleaning the labelling strips (NoteBoards) with a cleaning agent may damage the coating on them. Use clean water only to wipe the NoteBoards.

- Label the NoteBoard with the chalk pen supplied.
Alternatively, we recommend the following products for labelling:
 - liquid chalk pens, such as an edding 4095 chalk marker
 - traditional blackboard chalk

 Risk of damage due to writing with the wrong products.

Never write on the NoteBoard with a ballpoint pen, crayon or pencil, correction pencil, wax crayon, oil chalk or felt-tip pen (e.g. permanent marker, highlighter, foil pen, etc.). They are difficult or impossible to remove from the NoteBoard.

Only use the products recommended to write on the NoteBoard as these can be removed easily.

Before using for the first time

- Remove all packaging material and protective film.

The short, cross-fixed slats are only used to attach the remaining slats to the wooden shelf.

The short slats can be removed and safely disposed of with household waste. These slats come from surplus production and are used as transport safety devices for reasons of sustainability.



- Clean the inside of the appliance and the accessories (see “Cleaning and care”).

Connecting the wine conditioning unit

- Connect the wine conditioning unit to the electricity supply as described in “Installation – Electrical connection”.

Miele will then appear in the appliance display, followed by .

Activating the charcoal filter (Active AirClean filter)

- Activate the Active AirClean filter display  (see “Adjusting settings – Activating the Active AirClean filter display ”).

Positioning the slats on the wooden shelves

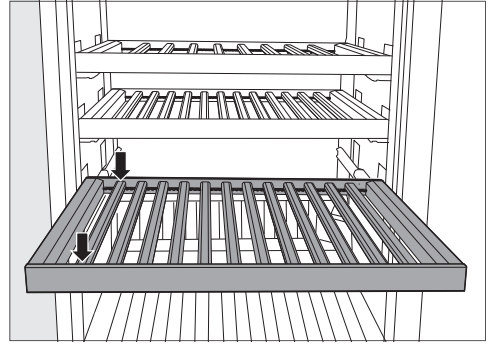

- Position the slats at equal intervals on the wooden shelf and lock them into position.

This provides space on the wooden shelf for the maximum number of bottles (0.75 l; Bordeaux-style bottles).

Setting up the stacking aid

The stacking aid helps to achieve the maximum capacity in the wine conditioning unit.

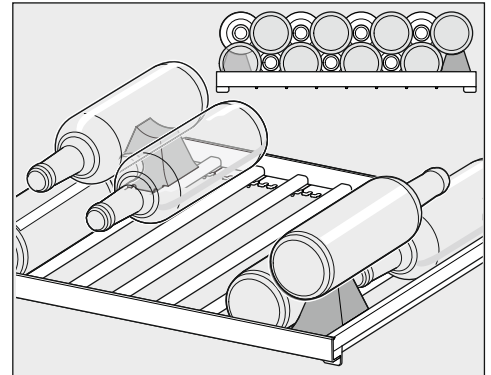

- Insert the stacking aid on the right and left between the two outer slats on the wooden shelf.

Commissioning

Switching on the wine conditioning unit



- Tap  on the display.

If you do not interact with the display for a certain period of time, it switches to energy-saving mode and goes dark.

The wine conditioning unit will start to cool and the interior lighting will come on when the appliance door is opened.

Depending on the ambient temperature and the temperature setting, it can take the appliance a few hours to reach the temperature required and for this temperature to then be shown as a constant temperature in the display.

Switching off the wine conditioning unit

- Tap .
- Swipe left or right until  is shown in the middle.
- Tap .

The cooling and interior lighting are switched off.

 will appear in the display.

Please note: the wine conditioning unit is not disconnected from the power supply when it is switched off.

Switching off for longer periods of time

If, during a long absence, the wine conditioning unit is switched off but not cleaned and the door is left shut, there is a danger of mould building up inside the appliance.

The wine conditioning unit must be cleaned.

If the wine conditioning unit is not going to be used for a longer period of time, observe the following:

- Switch the wine conditioning unit off.
- Switch off at the wall and withdraw the plug from the socket, or switch off the mains circuit breaker.
- Clean the wine conditioning unit and leave the door ajar to air the wine conditioning unit and avoid odours building up inside it.

Setting the temperature

A temperature of between 12 and 14 °C is recommended to store wine over the long term.

- Touch the temperature display on the display.
- Swipe left or right until the temperature you want is shown in the middle.
- Tap the temperature you want to confirm.
- To leave this Settings level, tap ↩.

The temperature display will then change back to the current temperature in the wine conditioning zone.

The temperature in the wine conditioning unit will rise:

- the more often the appliance door is opened and the longer it is kept open.
- the more wine bottles there are being stored.
- the warmer the newly stored wine bottles are.
- the higher the ambient temperature surrounding the wine conditioning unit. This wine conditioning unit is designed for use within specific ambient temperatures (climate range). Do not use it in ambient temperatures for which it is not designed.

Temperature range

The temperature can be adjusted from 5 to 20 °C.

Temperature display

In normal operation, the temperature display shows the **current average temperature** inside the wine conditioning unit.

Depending on the ambient temperature and the temperature setting, it can take the appliance a few hours to reach the temperature required and for this temperature to then be shown as a constant temperature in the display.

Setting the humidity (ActiveHumidity) in the lower wine conditioning zone ◌-◌

An ambient temperature of between 19 and 28 °C is required to ensure that the humidity level is set correctly.

- Tap the temperature display for the lower wine conditioning zone.
- Swipe left until ◌-◌ is shown in the middle.
- Tap ◌-◌.
- Swipe left or right until the humidity (◌ or ◌◌◌) you want is shown in the middle.
- Tap the setting you want to confirm.
- To leave this Settings level, tap ↩.

Depending on the ambient temperature and the set humidity level, it can take the appliance a few days to reach the set humidity level.

Humidity range

You can set the humidity to 2 levels and therefore adapt it to your individual needs.

- ◌: Low humidity
- ◌◌◌: High humidity

If you would like to use the lower wine conditioning zone for the long-term storage of wine bottles with natural corks, we recommend setting a high humidity level ◌◌◌.

Operation





Please bear in mind that energy consumption will increase slightly as the set humidity level is increased.

Explanation of the different settings

The door alarm and other warnings are automatically disabled when the appliance is in Settings mode .



Setting the brightness of the feature lighting

The feature lighting can be set at different brightness levels or switched off completely.



- Tap .
- Swipe left or right until  is shown in the middle.
- Tap .
- Select the brightness you want by swiping the segment bar to the left or right (level 1–7).
- If you want to switch the feature lighting off completely, swipe to the left until the segment bar goes out completely.
- Confirm the setting you want by tapping the segment bar.
- Alternatively: confirm the setting you want by tapping .
- To leave this Settings level, tap .
- Close the appliance door.

The modified setting will not be visible until after the appliance door has been closed.

Switching the lock function / on

- Tap .
- Swipe left or right until  is shown in the middle.
- Tap .

When the lock function is switched on,  will light up orange.

- To leave this Settings level, tap .
- Close the appliance door. Only then will the lock function  be active.

Deactivating the lock function / temporarily

If you want to adjust the temperature, for example, you can deactivate the lock function temporarily:





- Touch the temperature display.
- Touch  for approx. 6 seconds.

The display switches to the temperature controls.

- Now select the required settings.

Closing the appliance door will reactivate the lock function .

Switching the lock function / off completely





- Tap .
- Touch  for approx. 6 seconds.
- Swipe left or right until  is shown in the middle.
- Tap .

When the lock function is switched off,  will light up white.

- To leave this Settings level, tap .

Switching Sabbath mode on

When Sabbath mode  is switched on, you cannot adjust any settings.

- Tap .
 - Swipe left or right until  is shown in the middle.
 - Tap .
-  lights up orange.
- To leave this Settings level, tap .

Adjusting settings

If Sabbath mode  is switched on, this is indicated in the display for approx. 3 seconds.

The display then switches off.

Ensure that the appliance door is properly closed, as visual and audible alarms are switched off.

Switching Sabbath mode off

The Sabbath mode function  will switch off automatically after approx. 80 hours.

However, you can switch the Sabbath mode function  off early.

- Tap on the black display.

 will appear in the display.

- Tap .

 lights up orange.

- Tap the  icon again.

When Sabbath mode is switched off,  will light up white.

- To leave this Settings level, tap .

Changing the time before the door alarm is triggered

- Tap .

- Swipe left or right until  is shown in the middle.

- Tap .

- Swipe left or right until the time you want between 30 seconds and 3 minutes 30 seconds is shown in the middle.

- Tap the setting you want to confirm.

- To leave this Settings level, tap .

Setting up Miele@home for the first time

- Tap .

- Swipe left or right until  is shown in the middle.

- Tap .

- Tap on the connection method you wish to use (App or WPS).

After you have successfully logged in,  will appear in the display.

If a connection could not be created,  will appear.

- In this case, start the process again.

- To leave this Settings level, tap .

Deactivating the Wi-Fi connection

- Tap .

- Swipe left or right until  is shown in the middle.

- Tap .

- Tap  to deactivate the Wi-Fi connection.

 will appear in the display.

- To leave this Settings level, tap .

Activating the Wi-Fi connection

- Tap .

- Swipe left or right until  is shown in the middle.

- Tap .







- Tap  to activate the Wi-Fi connection.

 will appear in the display.

- To leave this Settings level, tap .

When the Wi-Fi connection is active,  will light up in the display.

Resetting the network configuration



- Tap .
- Swipe left or right until  is shown in the middle.
- Tap .
- Swipe right until  is shown in the middle.
- Tap .
- Tap .
- To leave this Settings level, tap .

All entered settings and values for Miele@home are reset to the default settings.

The Wi-Fi connection has been deactivated.  will go out in the start display.

Reset the network configuration if you are disposing of or selling your refrigeration appliance, or if you are putting a used refrigeration appliance into operation. All personal data is removed from the refrigeration appliance. This will also ensure that a previous owner is no longer able to access the appliance.



Switching off the keypad tone

- Tap .
- Swipe left or right until  is shown in the middle.
- Tap .

If the keypad tone is switched off,  will light up white.

- To leave this Settings level, tap .

Switching on the keypad tone



- Tap .
- Swipe left or right until  is shown in the middle.

- Tap .

If the keypad tone is switched on,  will light up orange.

- To leave this Settings level, tap .

Changing the volume of the alarms and buzzers

- Tap .
- Swipe left or right until  is shown in the middle.
- Tap .
- Select the volume you want by swiping the segment bar to the left or right (level 1–7).

- If you want to switch the alarms and buzzers off completely, swipe to the left until the segment bar goes out completely.





- Confirm the setting you want by tapping the segment bar.

When the alarms and buzzers are switched off,  will light up white.

When the alarms and buzzers are switched on,  will light up orange.

- To leave this Settings level, tap .

Changing the display brightness

- Tap .
- Swipe left or right until  is shown in the middle.
- Tap .
- Select the brightness you want by swiping the segment bar to the left or right (level 1–7).
- Confirm the setting you want by tapping the segment bar.
- To leave this Settings level, tap .

Adjusting settings





Changing the temperature unit °C/°F

- Tap .
- Swipe left or right until °C or °F is shown in the middle.
- Tap °C or °F to change the temperature unit.

°C or °F will appear in the display.





- To leave this Settings level, tap .

Switching off demo mode

- Tap .
- Tap .
- Swipe left or right until  is shown in the middle.
- Tap .



After demo mode  has been switched off, the refrigeration appliance shuts down and must be switched on again.

Resetting the settings to their factory default settings

- Tap .
 - Swipe left or right until  is shown in the middle.
 - Tap .
-  will appear in the display.
- Tap .

The refrigeration appliance shuts down and must be switched on again.

Activating the Active AirClean filter display

- Tap .
- Swipe left or right until  is shown in the middle.
- Tap .

If the Active AirClean filter display is activated,  will light up orange.

- To leave this Settings level, tap .

The data plate located inside the wine conditioning unit must not be removed. It contains information which is required in the event of a fault.

Do not let water get into the electronic unit or the lighting.

 Risk of damage due to moisture ingress.

The steam from a steam cleaning appliance can damage plastic parts and electrical components. Do not use a steam cleaner to clean the wine conditioning unit.

 Health risk due to soiling entering the appliance.

Soiling that enters the appliance from outside (such as food or drink residues) can cause fungus to form in the wine conditioning unit at increased temperature and humidity levels.

Only place clean wine bottles and clean accessories in the wine conditioning unit.

Cleaning agents

Cleaning and care products used inside the wine conditioning unit must be food safe.

To avoid damaging the surfaces of your appliance, **do not use:**

- cleaning agents containing soda, ammonia, acid or chloride
- cleaning agents containing descaling agents
- abrasive cleaning agents, e.g. powder cleaners and cream cleaners

- solvent-based cleaning agents
- stainless steel cleaners
- dishwasher cleaners
- oven sprays
- cleaning agents for ceramic glass cooktops (except to clean the glass front)
- glass-cleaning agents (except to clean the glass front: for this a glass-cleaning agent containing a little alcohol, but no citric or similar additives, may be used)
- hard, abrasive sponges and brushes, e.g. pot scourers
- dirt eraser sponges
- sharp metal scrapers

We recommend using lukewarm water with a little washing-up liquid to clean the appliance.

Preparing the wine conditioning unit for cleaning

- Switch the wine conditioning unit off.  appears in the display and the cooling system is switched off.
- Take any wine bottles out of the wine conditioning unit and store them in a cool place.
- If necessary, take out all removable parts for cleaning (see “Familiarising yourself with the appliance – Adjusting the interior fittings”).
- Take out any removable accessories for cleaning.

Cleaning the interior of the appliance

Clean the wine conditioning unit regularly, or at least once a month.

Cleaning and care

If soiling is left on for any length of time, it may become impossible to remove under certain circumstances. Surfaces may suffer discolouration or damage.

Remove any soiling immediately.

- Clean the interior with a clean sponge, lukewarm water and a little washing-up liquid.
- Rinse all parts by hand. Do not wash in a dishwasher.
- The **wooden** shelves should only be wiped with a well wrung-out moist cloth. They must **not** be allowed to get wet.

 Risk of damage from unsuitable cleaning agents.

Cleaning the labelling strips (NoteBoards) with a cleaning agent may damage the coating on them. Use clean water only to wipe the NoteBoards.

- After cleaning, wipe with a damp cloth and dry with a soft cloth.
- Leave the door open to air the wine conditioning unit sufficiently for a short while and to prevent odour build-up.
- Clean the appliance door with a proprietary glass cleaner.

Replacing the Active AirClean filter

New Active AirClean filters are available from Miele Customer Service, from a specialist dealer or on the Miele website.

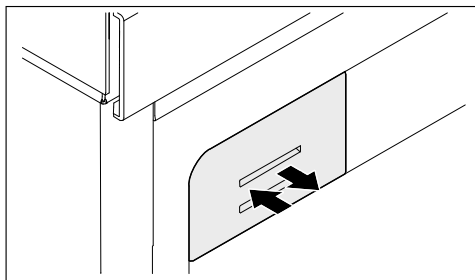

- Press in the filter holder, release it again and pull it out.

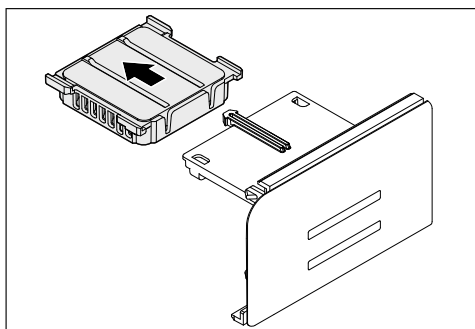

- Remove the used Active AirClean filter.
- Used Active AirClean filters can be disposed of with normal household waste.

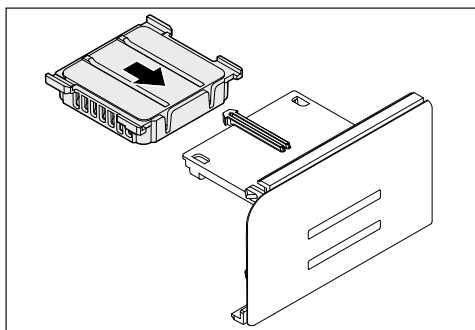

- Insert the new Active AirClean filter.

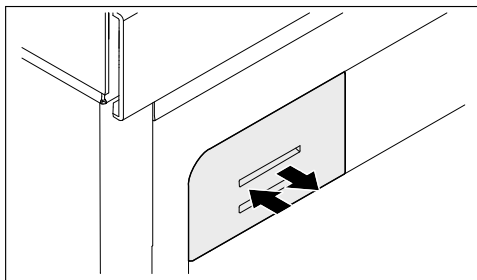

Automatic defrosting

The wine conditioning unit defrosts automatically.

- Push the filter cover in as far as it will go.

Cleaning the door seal

 Risk of damage due to incorrect cleaning.

If you treat the door seal with oils or grease, it can become porous.

Do not use any oils or grease on the door seals.

- The door seal should be cleaned regularly with clean water, and then wiped dry with a soft cloth.

Cleaning the ventilation gaps

A build-up of dust will increase the energy consumption of the appliance.

- The ventilation gaps should be cleaned on a regular basis with a brush or vacuum cleaner (you could use a Miele Vacuum Cleaner dusting brush, for example).

After cleaning

- Refit all shelves and accessories in the wine conditioning unit.
- Switch the wine conditioning unit on.
- Place the wine bottles in the wine conditioning unit and close the appliance door.

Problem solving guide

Many malfunctions and faults can be easily remedied. You can save time and money in many cases, as you do not need to contact Customer Service.





More information to help you remedy faults yourself can be found at www.miele.com.au/support/customer-assistance or www.miele.co.nz/support/customer-assistance.















To prevent cold from escaping, open the appliance as little as possible until the fault has been corrected.

Problem	Possible cause and remedy
The compressor is switching on more frequently and for longer periods of time. The temperature in the wine conditioning unit is falling.	<p>The ventilation openings are covered or have become too dusty.</p> <ul style="list-style-type: none">■ Do not block the ventilation openings.■ Clean the dust from the ventilation openings on a regular basis.
	<p>The appliance door has been opened too frequently. A large number of wine bottles have been placed in the appliance.</p> <ul style="list-style-type: none">■ Only open the appliance door when necessary and for as short a time as possible. <p>After a while, the temperature will return to normal by itself.</p>
	<p>The appliance door is not properly closed.</p> <ul style="list-style-type: none">■ Close the appliance door. <p>After a while, the temperature will return to normal by itself.</p>
	<p>The ambient temperature is too high. The higher the ambient temperature, the longer the compressor runs.</p> <ul style="list-style-type: none">■ See the information in “Installation – Installation site”.
	<p>The temperature in the wine conditioning unit is set too low.</p> <ul style="list-style-type: none">■ Correct the temperature setting.











General problems with the wine conditioning unit

Problem	Possible cause and remedy
There is no audible alarm even though the appliance door has been open for a long time.	<p>This is not a fault. The alarm has been switched off in Settings mode. If you want to switch the audible alarm back on again:</p> <ul style="list-style-type: none"> ■ Tap . ■ Swipe left or right until  is shown in the middle. ■ Tap . ■ Select the volume you want by swiping the segment bar to the right. ■ Confirm the setting you want by tapping the segment bar. <p>When the alarms and buzzers are switched on,  orange will appear.</p>







Messages in the display

Message	Possible cause and remedy
 lights up in the display and the wine conditioning unit is not getting cold. However, the appliance and the interior lighting are working fine.	<p>Demo mode has been activated.</p> <ul style="list-style-type: none"> ■ Tap . ■ Tap . ■ Swipe left or right until  is shown in the middle. ■ Tap . <p>After demo mode  has been switched off, the wine conditioning unit shuts down and must be switched on again.</p>
Nothing is visible in the display. The display is dark.	<p>Sabbath mode  is switched on: the interior lighting is switched off and the wine conditioning unit is cooling.</p> <ul style="list-style-type: none"> ■ Tap on the black display. <p> will appear in the display.</p> <ul style="list-style-type: none"> ■ Tap . <p> lights up orange.</p> <ul style="list-style-type: none"> ■ Tap the  icon again. <p>When Sabbath mode is switched off, the  symbol will light up white.</p> <p>Energy-saving mode is switched on: if you do not interact with the display for a certain period of time, it switches to energy-saving mode and goes dark.</p>

Problem solving guide

Message	Possible cause and remedy
 lights up in the display and the wine conditioning unit cannot be used.	<p>The lock function has been activated.</p> <ul style="list-style-type: none"> ■ Unlock the wine conditioning unit temporarily or switch the lock function off completely (see “Adjusting settings”).
 lights up in the display and a buzzer sounds.	<p>The Active AirClean filter display  is reminding you that the Active AirClean filter needs to be changed.</p> <ul style="list-style-type: none"> ■ Replace the Active AirClean filter (see “Cleaning and care – Replacing an Active AirClean filter (charcoal filter)”). Confirm that you have changed the Active AirClean filter by touching  in the display. <p> will go out in the display.</p>
 will light up yellow in the display; an alarm will also sound and the interior lighting will flash.	<p>The door alarm has been activated.</p> <ul style="list-style-type: none"> ■ Tap . <p>The alarm will stop,  will go out and the interior lighting will light up again constantly.</p>
 lights up red in the display and an alarm also sounds.	<p>The temperature alarm has been activated; the temperature has risen higher or fallen lower than the temperature set.</p> <p>Possible reasons for this include:</p> <ul style="list-style-type: none"> – The appliance door has been opened too frequently. – The ventilation openings have been blocked. – A prolonged power cut (mains outage) has occurred. <ul style="list-style-type: none"> ■ Tap . <p> goes out and the alarm will stop.</p> <p>The warmest temperature recorded in the wine conditioning unit will flash for about 1 minute in the temperature display. Then the temperature display will change to the current temperature.</p> <p>You can exit the flashing temperature display early:</p> <ul style="list-style-type: none"> ■ Touch the temperature display. <p>The warmest temperature displayed will disappear. The temperature display then reverts to showing the current temperature in the wine conditioning unit.</p> <ul style="list-style-type: none"> ■ Rectify the cause of the alarm.

Problem solving guide









Message	Possible cause and remedy
<p> lights up red in the display and an alarm also sounds.</p>	<p>Indication of a power failure: the temperature in the wine conditioning unit over the last few days or hours has risen too high because of a power failure or interruption to the power supply.</p> <ul style="list-style-type: none"> ■ Tap . <p> goes out and the alarm will stop.</p> <p>The warmest temperature recorded in the wine conditioning unit will flash for about 1 minute in the temperature display. Then the temperature display will change to the current temperature.</p> <p>You can exit the flashing temperature display early:</p> <ul style="list-style-type: none"> ■ Tap the temperature display. <p>The warmest temperature displayed will disappear. The temperature display will revert to showing the current temperature. The wine conditioning unit will go back to the last temperature setting when the power is back on.</p> <ul style="list-style-type: none"> ■ Rectify the cause of the alarm.
<p> lights up red in the display and a fault code F with numbers may appear. An alarm tone also sounds.</p>	<p>There is a fault.</p> <ul style="list-style-type: none"> ■ Tap  on the display to switch the alarm off. ■ Call Customer Service. <p>To report the fault, you need the fault code and also the model identifier and serial number of your wine conditioning unit. You can access this information in the display.</p> <ul style="list-style-type: none"> ■ To do this, touch  in the display. <p>The appliance data required will be shown in the display.</p> <p>Confirm with  to exit the information display and the fault code will be shown again in the display.</p> <p>The wine conditioning unit can be switched off directly from the fault message display.</p> <hr/> <p>There is an appliance fault: this display always has priority over any settings which have just been selected.</p> <p>An appliance fault has priority over any current door and/or temperature alarms in the display.</p>

Problem solving guide

Interior lighting

Problem	Possible cause and remedy
 Risk of electric shock due to exposed, live electrical components! When removing the lighting cover, there is a risk of coming into contact with live electrical components. Do not remove the lighting cover. The LED lighting must only be repaired or replaced by a qualified technician.	

 Danger of injury from LED lighting. This lighting corresponds to risk group RG 2. If the cover is defective, there is a risk of eye injury. Do not look from a close range directly into the lighting with optical instruments (e.g. magnifying glass or similar).	
---	--

Problem	Possible cause and remedy
The interior lighting is not working.	The wine conditioning unit is not switched on. ■ Switch the wine conditioning unit on.
	Sabbath mode  is switched on: the display is dark and the wine conditioning unit is cooling. ■ Tap on the black display.  will appear in the display. ■ Tap  .  lights up orange. ■ Tap the  icon again. When Sabbath mode is switched off,  will light up white.
	To avoid overheating, the interior lighting switches itself off automatically after approx. 15 minutes if the appliance door is left open. If this is not the case, there is a fault. ■ Call Customer Service.
The interior lighting is on even when the appliance door is closed.	This is not a fault. The feature lighting is switched on. ■ To switch off the feature lighting, touch the sensor control for the feature lighting  in the display. The  sensor control no longer lights up orange.

You can find information on how to remedy faults yourself at www.miele.com.au/support/customer-assistance or www.miele.co.nz/support/customer-assistance and about Miele spare parts at www.miele.com.au/service or www.miele.co.nz/service.

Warranty

The manufacturer's warranty for this appliance is 2 years.

For more information about country-specific warranty terms and conditions, please contact Miele.

Contact in case of fault

In the event of a fault which you cannot remedy yourself, please contact Miele.

You can book a Miele customer service call-out online at www.miele.com.au/service or www.miele.co.nz/service.

Contact information for Miele can be found at the end of this booklet.

Please quote the model and serial number of your appliance when contacting Miele. Both of these can be found on the data plate inside the refrigeration appliance or, depending on the model, in the settings mode under information **i**.

Optional accessories

Miele all purpose microfibre cloth

Light soiling and fingerprints on stainless steel fronts, control panels and furniture can be easily removed with this microfibre cloth.

Charcoal filter (Active AirClean filter)

The Active AirClean filter ensures optimum air quality in the wine conditioning unit by filtering the incoming air.

Optional accessories can be ordered from the Miele webshop. They can also be ordered directly from Miele (see end of this booklet for contact details).

Installation site

 Risk of damage and injury from the wine conditioning unit tipping over.

The wine conditioning unit is very heavy and can tip forward when the appliance door is open.

Keep the appliance door shut until the wine conditioning unit has been built in and secured in its building-in niche in accordance with these operating and installation instructions.

 Fire risk and danger of damage from open flames!

Open flames can set fire to the wine conditioning unit.

Keep open flames (e.g. a candle) away from the wine conditioning unit.

 Fire hazard and risk of damage from appliances that give off heat.

Appliances which give off heat can catch fire and set fire to the wine conditioning unit.

This wine conditioning unit must not be installed underneath a cooktop.

 Risk of damage caused by appliances discharging vapours. Installing appliances that discharge vapours behind the wine conditioning unit will put it at risk of damage.

Do not install appliances that discharge air or vapours behind the wine conditioning unit. Provide a separate air guide or install a partition wall between the appliances.

 Risk of damage due to high humidity.

In environments with high humidity, condensation can build up on the external wine conditioning unit panels.

This condensate can cause corrosion on external appliance panels.

Install the wine conditioning unit with sufficient ventilation in a dry and/or air-conditioned room.

After installation, please make sure that the appliance door closes properly and that the specified ventilation openings are adhered to.

This appliance should be installed in a dry, well-ventilated room.

When deciding on the installation site, please bear in mind that the energy consumption increases if the wine conditioning unit is installed near a heater, a cooker or another appliance that gives off heat. Direct sunlight should also be avoided.

The higher the room temperature, the longer the compressor runs and the higher the energy consumption is.

When installing the wine conditioning unit, please note the following:

- The mains socket must not be located directly behind the appliance and should be easily accessible.
- The mains plug and power supply cord must not touch the rear of the wine conditioning unit as they could be damaged by vibrations from the wine conditioning unit.
- Other appliances should not be plugged into a socket located directly behind this wine conditioning unit.

Installation

- When installing the wine conditioning unit, make sure that the power supply cord does not get trapped or damaged.
- Do not position or operate multi-socket adapters, distributor strips or other electronic devices (such as halogen transformers) at the rear of the appliance.
- The floor at the installation site must be horizontal and level and must be as high as the surrounding floor.



Risk of injury from broken glass.
If installed at altitudes above 1500 m there is a risk of the glass in the door breaking because of changes in air pressure. Shards of glass can cause severe injury.
The wine conditioning unit must not be installed at altitudes above 1500 m.

Climate range

This wine conditioning unit is designed for use within specific ambient temperatures (climate range). Do not use it in ambient temperatures for which it is not designed. The climate range is stated on the data plate inside the wine conditioning unit.

Climate range	Ambient temperature
SN	10 to 32 °C
N	16 to 32 °C
ST	16 to 38 °C
T	16 to 43 °C
SN-ST	10 to 38 °C
SN-T	10 to 43 °C

A lower ambient temperature will cause the compressor to switch off for longer periods, meaning that the wine conditioning unit is unable to maintain the required temperature in some circumstances.

Ventilation

Ventilation takes place through a ventilation grille in the wine conditioning unit plinth.



Risk of fire and damage due to insufficient ventilation!
If the wine conditioning unit is not ventilated sufficiently, the compressor will run more frequently and for longer periods. This will result in increased energy consumption and a higher operating temperature of the compressor. This, in turn, can result in damage to the compressor.
Please ensure that there is adequate ventilation around the wine conditioning unit.
It is essential to observe the required ventilation openings.
The ventilation openings must not be covered or blocked in any way.
They must also be cleaned on a regular basis to remove dust.

Side-by-side units

This wine conditioning unit can be installed side by side with another refrigeration appliance.

The side-by-side installation kit is available from Miele.

Miele will be able to advise you which combination of models is possible with your wine conditioning unit.

Instructions for installing appliances side by side can be found in the side-by-side installation kit installation instructions.

 Risk of injury and damage!

The glass door can drop.
When changing the door hinging, make sure that all fixing parts are securely screwed into position.

Be careful not to damage the door seal. If the door seal is damaged, the appliance door may not close properly and cooling will be insufficient.

Changing the door hinging

 Danger of injury and damage to the appliance due to heavy door.

There is an increased danger of injury and damage if the door hinging is installed by a single person.

Always change the door hinging with the help of a second person.

 Risk of crushing at the hinge.

Fingers can get trapped in or around the hinge.

Do not reach into the hinge when opening and closing the door.

The wine conditioning unit is supplied with right-hand hinging. If left-hand hinging is required, the door hinging must be changed (see accompanying installation instructions) before the wine conditioning unit is installed in the niche.

Useful tip: Place a suitable cover on the floor in front of the wine conditioning unit to protect the appliance door and your floor from damage.

Installation

Installation dimensions

Niche/side view

All dimensions are given in mm.

The wine conditioning unit will function correctly if the specified ventilation openings are kept clear.

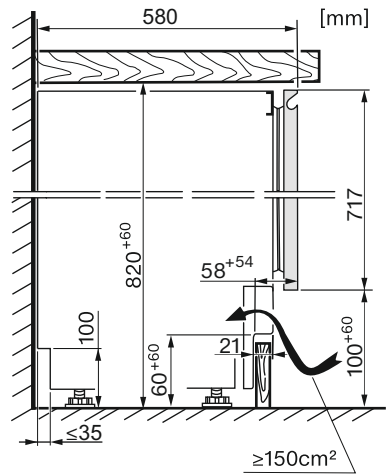
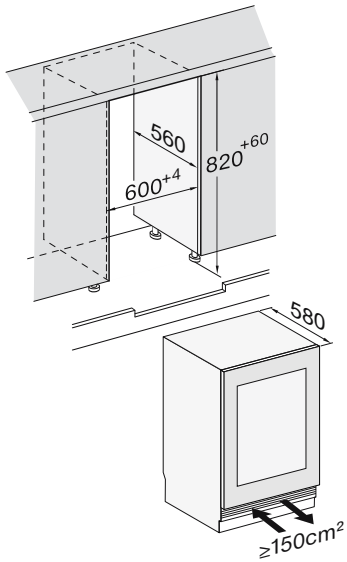

Connections

All dimensions are given in mm.

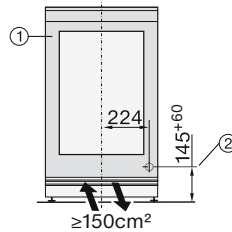
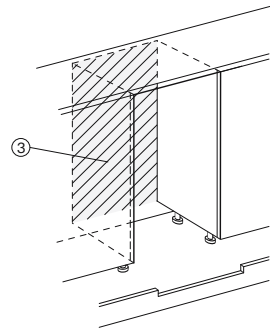
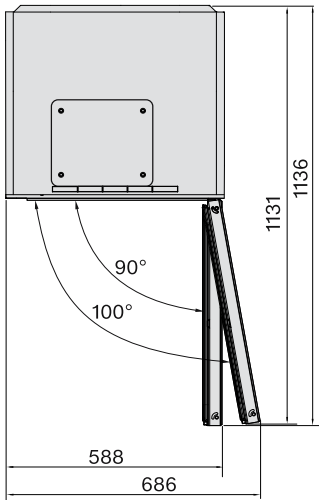









- ① Front view
- ② Power supply cord, length = 2200 mm
- ③ No connections permitted in the rear panel

Installation

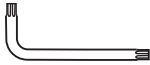
Installing the wine conditioning unit

To install the wine conditioning unit, you will need the following tools:

 TX 15, TX 20	 13
 TX 15	 6
 8	
	
	

Useful tip: Store the enclosed metal rod in a safe place. It is required for adjusting the rear appliance feet.

Preparing the wine conditioning unit

- Position the wine conditioning unit in front of the housing unit.
- Grasp the plinth panel at the side and pull it off towards the front.

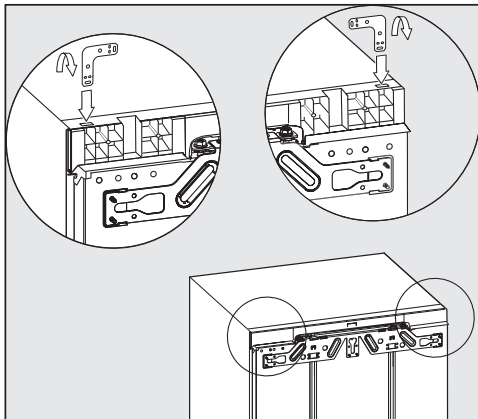

- Fit the bracket in the opening in the appliance lid.
- Bend the bracket at the perforated point.

Pushing in the wine conditioning unit

 Risk of damaging the power supply cord.
When pushing the wine conditioning unit into its niche, the power supply cord can get trapped and damaged. Push the wine conditioning unit carefully into the niche.

 Risk of damaging the floor.
Moving the wine conditioning unit can cause damage to the floor. Move the wine conditioning unit carefully on floors that are sensitive to scratching.

 Risk of damaging the appliance feet.
The appliance feet can break off. The feet should be almost fully screwed in when you push the wine conditioning unit into the niche.

Useful tip: Loosen the two rear feet by half a turn before pushing the appliance in. After pushing it into the niche, the feet will be easier to adjust from the front (see “Aligning the wine conditioning unit”).

- Position the power supply cord so that the wine conditioning unit can be connected easily once installed.

Useful tip: To help you push the appliance into position, tie a piece of string around the mains plug to “increase” the length of the power supply cord. Then pull the power supply cord by the end of the string through the housing unit.

If the wine conditioning unit is pushed too far into the niche, the appliance door may not close properly once the furniture panel has been fitted. This can cause ice to build up, condensate to accumulate and lead to faults in the appliance. These can all lead to increased energy consumption.

Push the wine conditioning unit into the building-in niche, making sure a gap of **42 mm** is maintained all round between the appliance carcass and the front of the housing unit side walls.

- Push the refrigeration appliance into the niche until the front edges of the hinges at the top and bottom are flush with the front edge of the housing unit side wall.

This will create a gap all round of **42 mm** to the front edges of the housing unit side walls.

With **furniture with door fittings (e.g. stubs, seals etc.)** the dimension of these must be taken into account when making sure there is a gap all round of **42 mm**.

- Pull the wine conditioning unit forwards by the appropriate dimension.
- Check again to make sure there is a gap of **42 mm** to the front edges of the door fittings.

Useful tip: If possible, remove door fittings and push the wine conditioning unit into the niche until all fixing brackets at the top and bottom are in line with the front edge of the housing unit side wall.

Aligning the wine conditioning unit

When securing the wine conditioning unit in the niche at the top, it should sit lightly tensioned between the floor and the worktop.

- Adjust the front and rear feet alternately according to the niche height and make sure the wine conditioning unit is correctly aligned.

Proceed as follows:

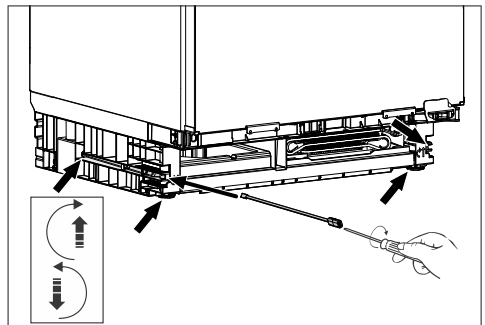

Installation

- Adjust both rear feet with appropriate screws at the front right and left in the appliance plinth using the rod supplied and a flat-tip screwdriver.
- Unscrew the two front feet alternately with the rear ones. The maximum adjustment range is 6 cm.

Useful tip: As soon as the feet have been unscrewed slightly, you can adjust them with a screwdriver at the bottom of the foot.

The foam ① attached to the ventilation grille ensures the airflow is separated to prevent malfunctioning of the appliance.

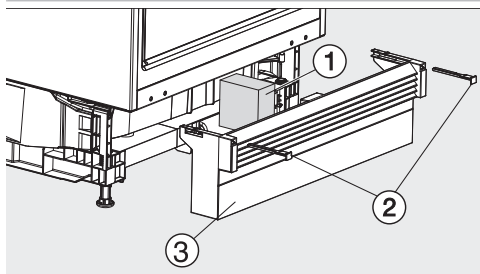

- Replace the plinth panel with the ventilation grille ③, but do not fix it in place yet.

Without a continuous plinth panel:

- Pull the plinth panel ③ forwards until the ventilation slots are in alignment with adjacent cabinet plinth panels.

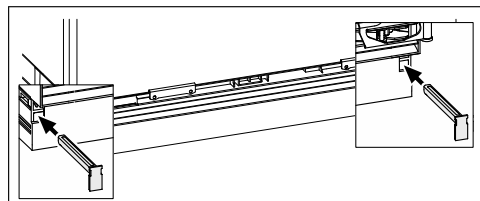

- Hold the plinth panel securely and attach it to the right and left using the bolts supplied ②.

With the plinth panel attached, the rear feet can only be adjusted when the plinth panel is fully inserted. Otherwise, the rod is not long enough.

With a continuous plinth panel:

- Push the plinth panel with the ventilation grille ③ right up against the wine conditioning unit, and attach it to the right and left using bolts ②.

If a continuous plinth panel is to be fitted, a suitable ventilation gap will need to be made in it for the ventilation grille of the wine conditioning unit.

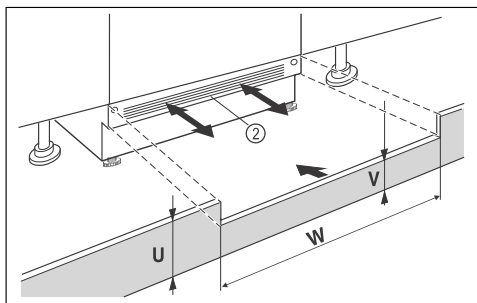

- Trim the furniture plinth panel (U) to the correct height.
- Adjust the height (V) along the niche width (W) underneath the appliance plinth ②.

Aligning the wine conditioning unit to taller furniture doors

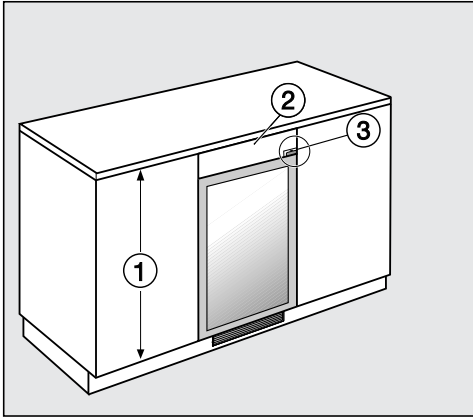

If adjacent furniture doors ① are taller than the wine conditioning unit door, the wine conditioning unit can be aligned to the adjacent furniture doors using a filler panel ②.

The filler panel must be made exactly to measure. Please also take into account the door hinge ③ when having the filler panel made (depending on the model).

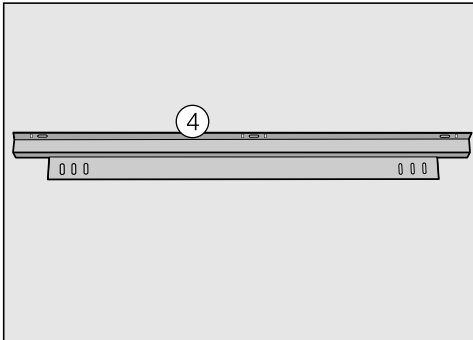

A fixing bracket ④ is required to secure the filler panel. This is available from Miele Customer Service or from specialist dealers. The fixing bracket is fitted on the wine conditioning unit:

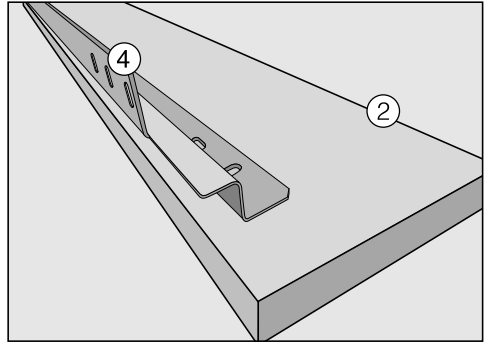
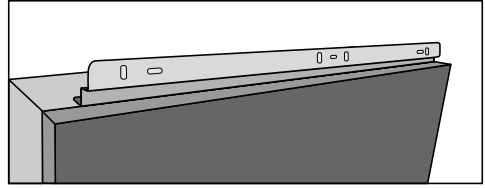

- Fix the fixing bracket ④ to the back of the filler panel ②.
- Pull the wine conditioning unit as far as you need to out of the niche so that you can tilt it towards you.
- Loosely screw the fixing bracket ④ with the filler panel ② to the wine conditioning unit.
- Align the filler panel to the wine conditioning unit door to give a flush finish.
- Now tighten the screws.
- You can now push the wine conditioning unit into the niche.

Installation

Securing the wine conditioning unit in the niche

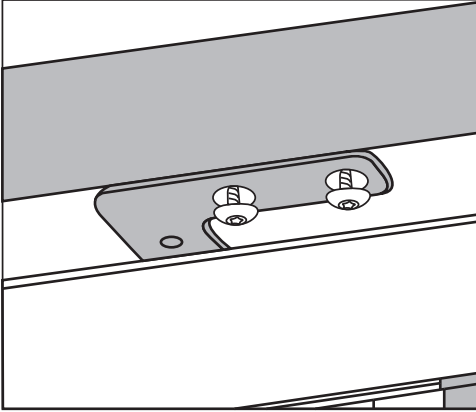

- Screw the wine conditioning unit in place underneath the worktop with two screws in each case.

Electrical connection

The refrigeration appliance must only be connected to an earthed socket using the connection cable supplied.

The socket should be easily accessible after the refrigeration appliance has been installed. If the socket is not easily accessible, ensure that a suitable means of disconnection is provided on the installation side for each pole.

 Risk of fire from overheating.

Connecting the appliance to a multi-socket plug adapter or to an extension lead can overload the cable.

For safety reasons, do not use an extension cable or multi-socket adapter.

All electrical work must be carried out by a suitably qualified and competent person in strict accordance with national and local safety regulations.

For safety reasons, we recommend using a suitable residual current device (RCD) in the relevant electrical installation for connecting the refrigeration appliance.

If the mains connection cable is damaged, it must only be replaced with a specific mains connection cable of the same type (available from Miele).

The data plate indicates the nominal power consumption and the connection data. Compare this information with the data of the on-site electrical connection. If in any doubt, consult a qualified electrician.

Temporary or permanent operation with a self-sufficient or non-mains synchronous energy supply system (e.g. isolated networks, back-up systems) is possible. A requirement for the

operation is that the energy supply system complies with all current local and national requirements that apply to stand-alone, solar and/or battery systems.

The protective measures provided in the domestic installation and in this Miele product must also be assured in their function and operation in isolated operation or in non-mains synchronous operation, or replaced with equivalent measures in the installation.

Connecting the appliance

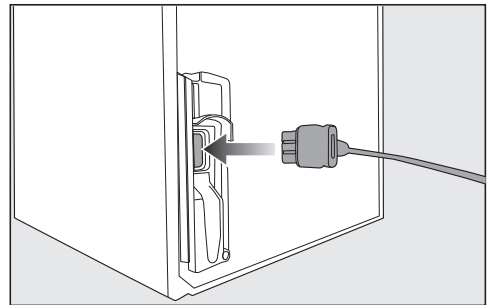

■ Insert the plug connector into the back of the appliance.

Make sure that the plug connector has locked into position correctly.

■ Insert the plug of the appliance into the socket and switch it on.

The appliance is now connected to the electricity supply.

Miele Australia Pty. Ltd.

ACN 005 635 398, ABN 96 005 635 398

Miele Head Office Melbourne:

Level 4, 141 Camberwell Road

Hawthorn East, VIC 3123

1300 464 353 (1300 4 MIELE)

info@miele.com.au

www.miele.com.au

Hong Kong, China

Miele (Hong Kong) Ltd.

41/F - 4101, Manhattan Place

23 Wang Tai Road, Kowloon Bay

Hong Kong

Tel.: (852) 2610 1025

Fax: (852) 3579 1404

E-mail: customerservices@miele.com.hk

Website: www.miele.hk

India

Miele India Pvt. Ltd.

1st Floor, Copia Corporate Suites,

Commercial Plot 9,

Mathura Road, Jasola,

New Delhi - 110025

E-mail: customercare@miele.in

Website: www.miele.in

Malaysia

Miele Sdn Bhd

Suite 12-2, Level 12

Menara Sapura Kencana Petroleum

Solaris Dutamas No. 1, Jalan Dutamas 1

50480 Kuala Lumpur, Malaysia

Phone: +603-6209-0288

Fax: +603-6205-3768

Miele Global Headquarters Germany

Miele & Cie. KG, Carl-Miele-Straße 29, 33332 Gütersloh, Federal Republic of Germany

Miele New Zealand Ltd.

IRD 98 463 631

Head Office:

8 College Hill

Freemans Bay, Auckland 1011

0800 464 353 (0800 4 MIELE)

customercare@miele.co.nz

www.miele.co.nz

Singapore

Miele Pte. Ltd.

29 Media Circle

#11-04 ALICE@Mediapolis

Singapore 138565

Tel: +65 6735 1191

Fax: +65 6735 1161

E-mail: info@miele.com.sg

Internet: www.miele.sg

South Africa

Miele (Pty) Ltd

63 Peter Place, Bryanston 2194

P.O. Box 69434, Bryanston 2021

Tel.: (011) 875 9000

Fax: (011) 875 9035

E-mail: info@miele.co.za

Internet: www.miele.co.za

Thailand

Miele Appliances Ltd.

BHIRAJ TOWER at EmQuartier

43rd Floor Unit 4301-4303

689 Sukhumvit Road

North Klongton Sub-District

Vadhana District

Bangkok 10110, Thailand

KWTUS 7054 ...

en - AU, NZ

M.-Nr. 12 794 630 / 01