

linärie

GRENOBLE
INDUCTION
COOKTOP

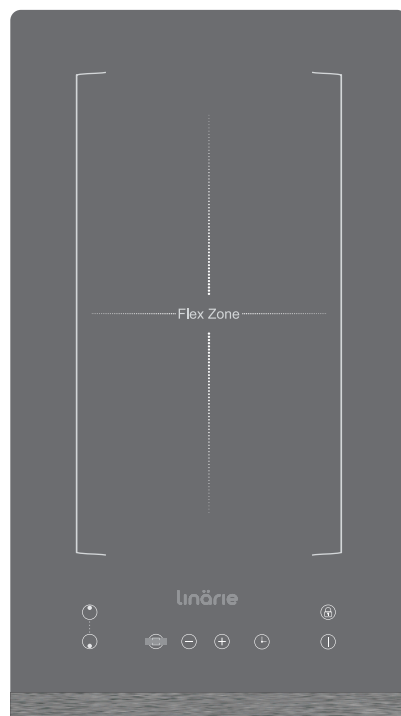

LS3011F

EN Operation, Installation
& Instruction Manual

www.linärie.com.au

Register
your
product
online

CONGRATULATIONS

Congratulations and thank you for choosing Linärie to introduce a new comfort of cooking in your home. We are sure you will find your new appliance a pleasure to use and a great asset to your kitchen.

This appliance complies with all relevant safety requirements in Australia. Inappropriate use can, however, lead to personal injury and damage to property.

In order to operate the unit correctly and safely, please read this instruction manual carefully before installation and usage. This user manual which provides you with all required instructions related to safety, installation, use and maintenance of the appliance.

For future reference, please store this booklet in a safe place and ensure that all users are familiar with the contents. Pass them on to any future owner of the appliance.

Record Model & Serial Number

Model:.....

Serial Number

Register your product www.linärie.com.au

IMPORTANT

Adherence to the directions for use in this manual is extremely important for health and safety. Failure to strictly adhere to the requirements in this manual may result in personal injury, property damage and affect your ability to make a claim under Linärie's manufacturer's warranty provided with your product. Products must be used, installed and operated in accordance with this manual. You may not be able to claim on Linärie's manufacturer's warranty in the event that your product fault is due to failure to adhere this manual.

Correct Conditions of Use

- The appliance is intended for use in the home and similar environments only. It is not intended for commercial use.
- The appliance is not suitable for outdoor use, non-stationary installation.
- The cooktop is to be used solely for preparing food at home. It may not be used for any other purpose.

 The electricity connection must be made by a qualified specialist. Installation must comply with the valid standards, regulations and laws. All safety and warning information and the operating and installation instructions must be complied with.

TABLE OF CONTENTS

1. General Information	03	5.3 How to use your induction cooktop	08
1.1 Appliance information		5.3.1 Start cooking	
2. General Safety Instructions	03	5.3.2 Finish cooking	
2.1 General safety information		5.3.3 Using the boost function	
2.2 Safety instruction - Installation		5.3.4 Locking the controls	
2.3 Correct use & Operation	04	5.3.5 Timer control	
2.4 Disassembling and Disposal of the Appliance		5.3.6 Flex zone	
2.5 Accessories and Spare parts		6. Cooking guidelines	10
3. Product introduction	04	6.1 Cooking tips	
3.1 Technical specification		6.2 Detection of small particles	
3.2 Top view		7. Heat settings	10
3.3 Touch control panel		8. Care and Cleaning	11
3.4 Working theory.....	05	9. Troubleshooting	11
4. Installation	05	10. Environmental tips	13
4.1 Selection of installation equipment		10.1 Disposal considerations	
4.2 Before installation	06	10.2 Disposing your old appliance	
4.3 After installation		11. Warranty and After sales	13
4.4 Before locating the fixing bracket		11.1 Warranty	
4.5 Adjusting the bracket position		11.2 After sales service	
4.6 Caution		11.3 Replacement of spare parts	
4.7 Connecting the cooktop to the main supply .	07		
5. Operation	07		
5.1 Touch control			
5.2 Choosing the right cookware			

Additional information on products, accessories, warranty, replacement parts and services can be found at www.linärie.com.au

1. GENERAL INFORMATION

1.1 Appliance Information

- A damaged appliance can be dangerous. If you find the appliance is damaged or marked, you must report it within 7 days if you wish to claim for damage/marks under the manufacturer's warranty. This does not affect your statutory rights. Do not use a damaged appliance.
- The manufacturer's warranty will be invalidated if the appliance is not repaired by a Linärie approved service technician.
- Faulty components must only be replaced by genuine Linärie spare parts. The manufacturer can only guarantee the safety of the appliance when Linärie replacement parts are used.
- If the power cord is damaged, it must only be replaced by a Linärie authorized service technician or suitably qualified electrician in order to avoid a hazard.
- Linärie cannot be held liable for noncompliance with these instructions, resulting from incorrect or improper use or operation.

2. GENERAL SAFETY INSTRUCTIONS

 The appliance complies with the stipulated safety requirements in Australia. The user is responsible for appliance cleaning and maintenance as well as its safe use. Improper use can lead to personal injury and damage to property.

2.1 General Safety Instructions

Children and People with Special Needs

WARNING

This appliance is not intended for use by persons (including children) with reduced physical, sensory or mental capabilities, or lack of experience and knowledge, unless they have been given supervision or instruction concerning use of the appliance by a person responsible for their safety.

- The appliance is NOT suitable for use by children without supervision.
- Young children should be supervised near the appliance to ensure they do not play with this appliance.
- Children may be able to wrap themselves in packing material or pull it over their heads with the risk of suffocation. Keep children away from any packing material.

Cleaning & Maintenance

The device must be cleaned regularly. Dirt can lead to damage or the buildup of odors. (See "Cleaning and maintenance" section).

- Always clean the appliance exactly as indicated in the operating instructions.
- Always ensure the appliance is switched off before cleaning or replacing parts.
- There is a risk of fire if cleaning is not carried out as described in these operating instructions.
- In areas which may be subject to infestation by cockroaches or other vermin, pay particular attention to keeping the machine and its surroundings in a clean condition at all times. Any damage which may be caused by cockroaches or other vermin will not be covered by the machine warranty.
- In order to avoid any potential hazard, the installation instructions must be followed.
- Do not cook on a broken or cracked cooktop. If the cooktop surface should break or crack, switch the appliance off immediately at the mains power supply and contact a qualified technician.

Unauthorized Modifications

Unauthorised modifications can cause the appliance to pose risks. Do not conduct any modifications to the appliance.

2.2 Safety Instructions - Installation

WARNING

The appliance must only be installed and assembled by trained specialists who are familiar with and comply with the standard national regulations and supplementary regulations of ventilation systems.

- Observe all regional regulations for the installation of ventilation systems.
- During installation, maintenance and repair work, the appliance must be disconnected from the mains electricity supply. It is only completely isolated from the electricity supply when:
 - the mains circuit breaker is switched off, or
 - it is switched off at the wall socket and the plug is withdrawn from the socket.
- Do not pull the mains connection cable but the mains plug to disconnect your appliance from the mains electricity supply.
- Do not connect the appliance to the mains electricity supply by a multi-socket unit or an extension lead.
- Tampering with electrical connections or components and mechanical parts is highly dangerous to the user and can cause operational faults. Only open the housing as described in the instructions given in "Installation" and in the "Cleaning & Maintenance" sections of this booklet. Under no circumstances should any other parts of the housing be opened.
- This appliance complies with electromagnetic safety standards.
- THIS APPLIANCE MUST BE PROPERLY EARTHED. It is most important that this basic safety requirement is present and tested regularly and, where there is any doubt, the household wiring system should be inspected by a qualified electrician.
- Linärie cannot be held liable for noncompliance with these instructions, resulting from incorrect or improper use or operation.

2.3 Correct Use & Operation

- For safety reasons, this appliance may only be used after it has been built in.
- Reliable and safe operation of this appliance can only be assured if it has been connected to the mains electricity supply.
- Before using the appliance, ensure that all packaging materials are removed from the appliance and make sure that the connection data on the data plate [voltage (V) and frequency (Hz)] indicated on the appliance corresponds to the voltage and frequency of the power supply in your household. Consult a qualified electrician if in doubt.
- Never leave the appliance unattended when in use. Boilover causes smoking and greasy spillovers may ignite.
- Never leave utensils or any objects on the appliance.
- Never use the appliance for warming or heating the room.

- After use, always turn off the cooking zones and the cooktop as described in this manual. Do not rely on the pan detection feature to turn off the cooking zones when you remove the pans.
- Only use the appliance on a dry, stable, level and horizontal surface and distance 10 cm back-round surrounding.
- When cooking, pay attention to the heat-up speed of the cooking zones. Avoiding boiling the pots dry as there is a risk of the pots overheating!
- Do not place empty pots and pans on cooking zones which have been switched on.
- Always switch off the cooktop after using.
- Fats and oils may ignite fire. Always be careful in preparing food with fats and oils. Never extinguish ignited fats and oils with water! Put the lid on the pan and switch off the cooking zone.

2.4 Disassembling and Disposal of the Appliance

(see the "Environmental Tips" section for best practices on disposing of this appliance).

The device must only be disassembled by trained specialists who are familiar with and comply with the standard national regulations and supplementary regulations of the local utility companies.

Work on electrical components must only be conducted by trained electrical personnel.

2.5 Accessories and Spare parts

Incorrect components can lead to personal injury or damage to the appliance. Only use original Linärie spare parts for repairs.

Modifications, additions or alterations to the appliance can lead to safety risks. If spare parts or accessories from other manufacturers are used, the warranty will be invalidated, and Linärie cannot accept liability.

Please check www.linarie.com.au for more information.

3. PRODUCT INTRODUCTION

3.1 Technical specification

Cooking cooktop	LS3011F
Cooking zones	2 Zones
Supply voltage	220-240V~50Hz or 60Hz
Installed electric power	3300W
Product size LxWxH (mm)	300x535x58
Building-in Dimensions A x B (mm)	278x492

Weight and dimensions are approximate.

Because we continually strive to improve our products that we may change the specifications and designs without prior notice.

3.3 Touch control panel

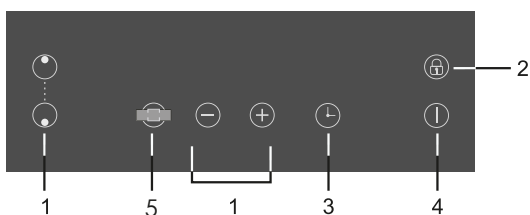

1. Cooking zone selector
2. Key lock
3. Timer
4. On/ Off
5. Flex zone

3.2 Top view

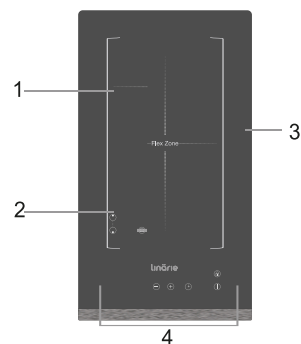

1. Max. 1500/1800 W zone
2. Max. 1200/1500 W zone
3. Glass plate
4. Control panel

cont. product introduction

3.4 Working Theory/ Advantage of Induction cooktop

Induction cooking is safe, advance, efficient, and economical cooking technology. It works by electromagnetic vibrations generating heat directly in the pan, rather than indirectly through heating the glass surface. The glass become hot only because the pan eventually warms it up. Energy-saving.

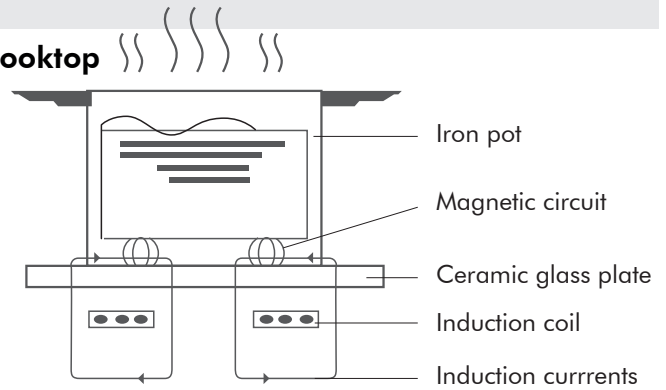

4. INSTALLATION

4.1 Selection of installation equipment

Cut out the work surface according to the sizes shown in the drawing. For the purpose of installation and use, a minimum of 5 cm space shall be preserved around the hole. Be sure the thickness of the work surface is at least 30mm. Please select heat resistant and insulated work surface material (wood and similar fibrous or hygroscopic material shall not be used as work surface material unless impregnated) to avoid the electrical shock and larger deformation caused by the heat radiation from the hotplate. As shown.

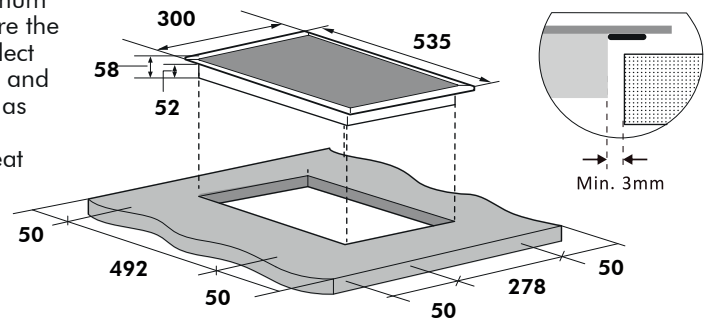

⚠ The safety distance between the sides of the cooktop and the inner surfaces of the worktop should be at least 3mm.

Under any circumstances, make sure the Induction cooktop is well ventilated and the air inlet and outlet are not blocked. Ensure the induction cooktop is in good work state. As shown below

⚠ : The safety distance between the hotplate and the cupboard above the hotplate should be at least 60mm. **Unit (mm)**

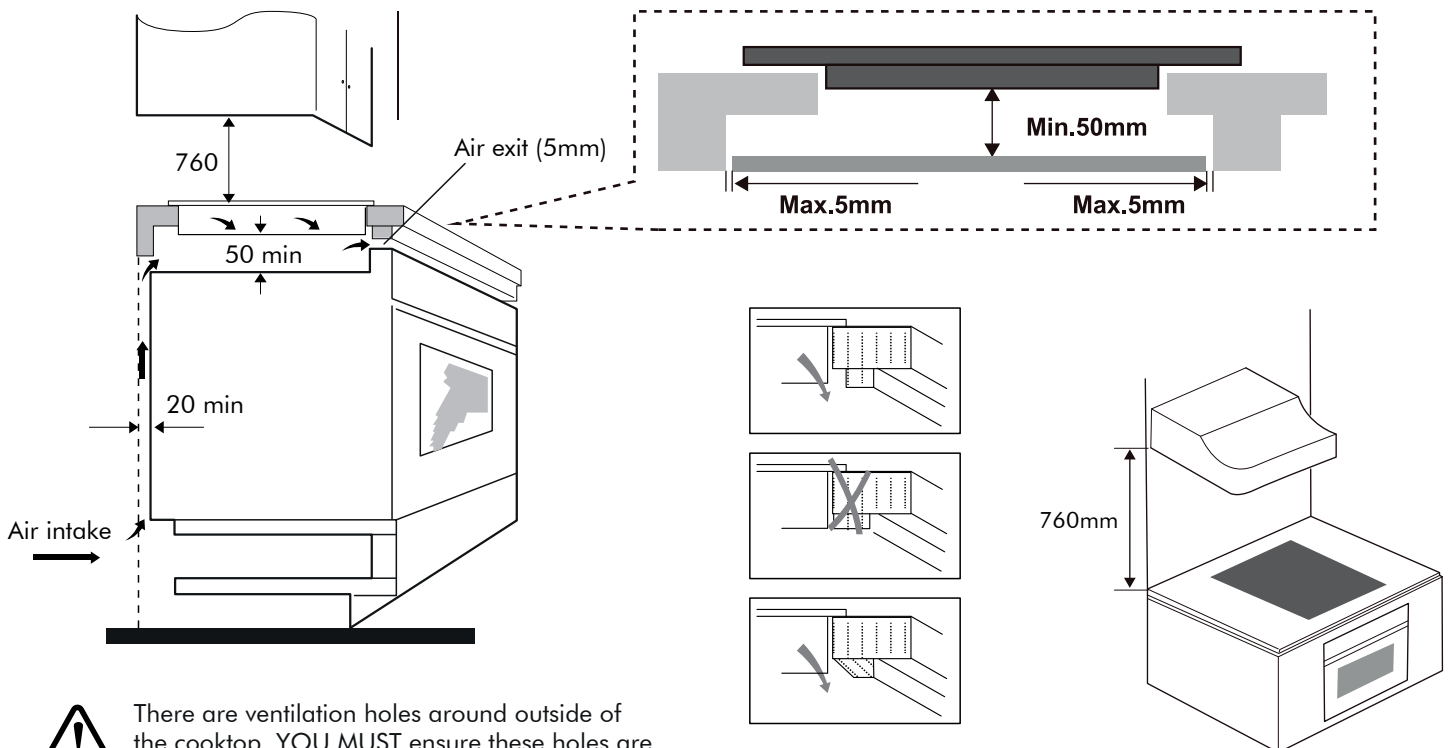

⚠ There are ventilation holes around outside of the cooktop. YOU MUST ensure these holes are not blocked by the worktop when you put the cooktop into position.

cont. installation



- The adhesive that join the plastic or wooden material of the furniture, **MUST** be heat resistant of not below 150°C.
- The rear wall, adjacent and surrounding surfaces must be able to withstand a temperature of 90°C.

4.2 Before Installation

- Be sure the work surface is square and level, and no obstruction with space requirements.
- The work surface is made of heat – resistant and insulated material.
- If the cooktop is installed above an oven, the oven must have a cooling fan.
- The installation will comply with all clearance requirements and applicable standards regulations.
- A suitable isolating switch providing full disconnection from the mains power supply is incorporated in the permanent wiring, mounted and position to comply with the local wiring rules and regulations.
- The isolating switch must be on an approved type and provide a 3 mm distance that separate all poles or in all active phase conductors if the local wiring rules allow for this variation of the requirements.
- The isolating switch will be easily accessible to the customer with the cooktop installed. You consult local building authorities and by- laws if in doubt regarding installation.
- You use heat resistant and easy to clean finishes such as ceramic tiles for the wall surfaces surrounding the cooktop.

4.3 After installation

- The power supply cable does not come in contact with cupboard doors or drawers.
- There is adequate flow of fresh air from outside the cabinet to the base of the cooktop.
- If the cooktop is installed above a drawer or cupboard space, a thermal protection barrier is installed below the base of the cooktop.
- The isolating switch is easily accessible.

4.4 Before locating the fixing brackets

- Gently place the unit on a stable and smooth surface. (You can use the packaging.)
- Do not apply force on the controls that showed from the cooktop.

4.5 Adjusting the bracket position

1. Gently place the appliance on a stable and smooth surface (use the packaging). Do not carry out any physical force on the control panel of the appliance.

2. Install and fix the brackets on the appliance as shown.

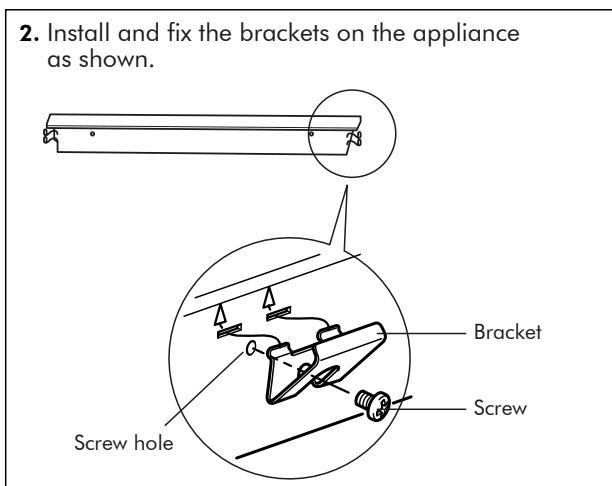

3. Insert and align the appliance into the installation opening.

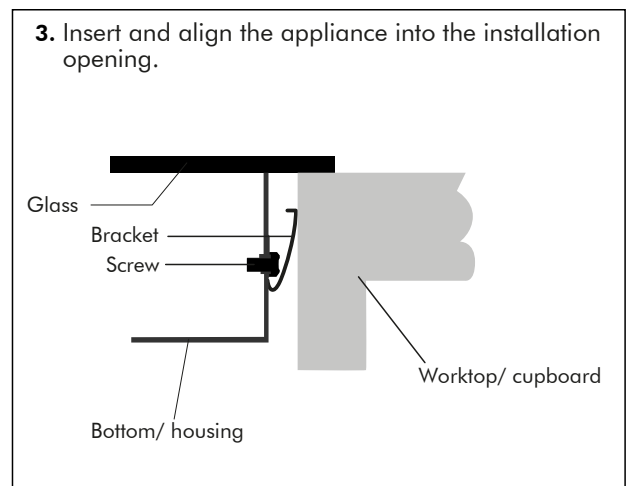

4.6 Caution

1. The induction hotplate must be installed by a qualified personnel or technicians. We have professionals at your service. Please never conduct the operation by yourself.
2. Do not install the cooktop directly above a dishwasher, fridge, freezer, washing machine or clothes dryer, as the humidity may damage the electronics
3. The induction hotplate shall be installed such that better heat radiation can be ensured to enhance its reliability.
4. The wall and induced heating zone above the table surface shall withstand heat.
5. To avoid any damage, the middle layer and adhesive must be resistant to heat.
6. Do not use a steam cleaner.

cont. installation

4.7 Connecting the cooktop to the mains power supply

> Suitable Only (for the model without plug).

The appliance must be connected to the mains by a qualified professional, who is familiar with and adheres to the local requirements and supplementary regulations of your electricity supplier.

1. Your household power supply must meet the power consumption of the appliance.
2. The voltage and power cord must meet the values on the technical data sheet.
3. Do not use adapters, reducers and branching devices as they can cause overheating.
4. The power chord must not come in contact with hot areas; and its temperature must not exceed 5°C.
5. When the socket is not accessible for the user or a fixed electrical connection of the appliances is required, an all-pole disconnecting device must be incorporated during installation. Disconnecting devices are switches with a contact opening distance of at least 3mm. These include LS – switches, fuses and protectors EN30335. Read the information on the technical data sheet and the connection diagram below before connecting the appliance to the mains. The electricity supply must be formed from a 16A automatic cut-out.
If in doubt, always contact the local building authorities and consult the relevant legal provisions.
6. Do not bend or compress the power chord.
7. Check the power chord regularly. The power chord must be replaced by a qualified professional only.

Installation (380V) rare

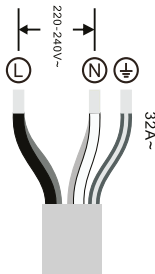
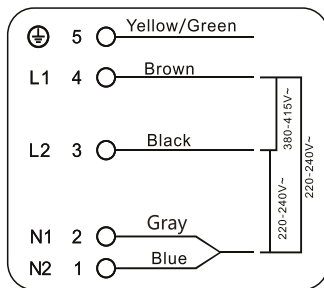

Installation (220V) common

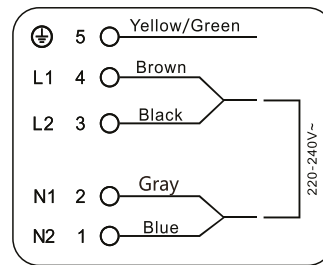

5. OPERATION

Before using your induction cooktop

- Read this guide, taking special note "Safety Warnings" section.
- Remove any protective film that may be still on your induction cooktop.

5.1 Touch control

- The controls respond to touch, so you don't need to apply any pressure.
- Use the ball of your finger, not its tip.
- You will hear a beep each time a touch is registered.
- Make sure the controls are always clean, dry, and that there is no object (e.g. a utensil or a cloth) covering them. Even a thin film of water may make the controls difficult to operate.

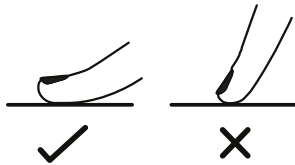

5.2 Choosing the right Cookware

- Only use cookware with a base suitable for induction cooking. Look for the induction symbol on the packaging or on the bottom of the cookware.
- You can check whether your cookware is suitable by carrying out a magnet test. Move a magnet towards the base of the pan. If it is attracted, the pan is suitable for induction.

If you do not have a magnet:

1. Put some water in the pan you want to check.
2. If  does not flash in the display and the water is heating, the pan is suitable.



- Cookware made from the following materials is not suitable: pure stainless, aluminum or copper without a magnetic base, glass, wood, porcelain, ceramic, and earthenware. Do not use cookware with jagged edges or a curved base.

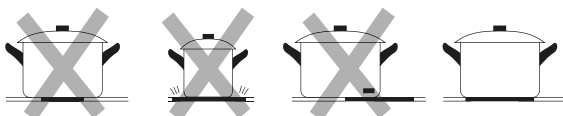

Always lift pans off the induction cooktop – do not slide, or they may scratch the glass.

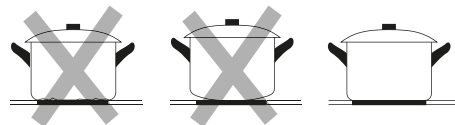
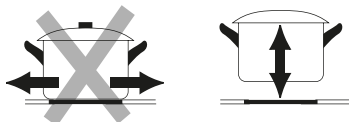

- Make sure that the base of your pan is smooth, sits flat against the glass, and is the same size as the cooking zone. Use pan whose diameter is as large as the graphic of the zone selected.
- Using a pot a slightly wider energy will be used at its maximum efficiency. If you use smaller pot efficiency could be less than expected. Pot less than 140 mm could be undetected. Always centre your pan on the cooking zone.

cont. operation

5.3 How to use your induction cooktop

5.3.1 Start cooking (please check control panel on page 3)

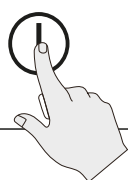
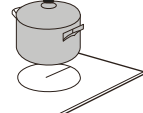
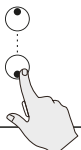
<p>While on the standby mode, touch the main power "ⓘ" key, the induction cooktop will make a "beeping sound" once indicating that it is ready to use. If only the indicator light above the "ⓘ" key is lit up, the cooking zone key is ON, or Locked key are not chosen within 30 seconds, the unit will automatically return to standby mode.</p>	
<p>Place a suitable pan on the cooking zone that you wish to use. Make sure the bottom of the pan and the surface of the cooking zone are clean and dry.</p>	
<p>To turn on one or more cooking zone, place a compatible pot or pan on the desired cooking zone. Touch the cooking zone selector key (corresponding to the chosen cooking zone), the power display will show a "-". Touch the chosen cooking zone key within 5 seconds.</p>	

5.3.2 Finish cooking

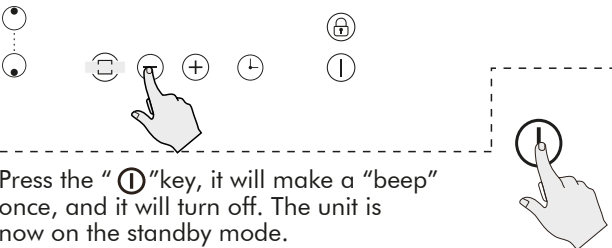
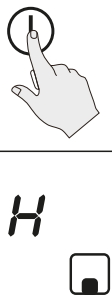
<p>Touch the key of the cooking zone you use, the digital display will blink, press "⊖" key to adjust "-", the cooktop will switch off.</p>	
<p>Press the "ⓘ" key, it will make a "beep" once, and it will turn off. The unit is now on the standby mode.</p> <p>H Beware of hot surfaces H will show which cooking zone is hot to touch. It will disappear when the surface has cooled down to a safe temperature. It can also be used as an energy saving indicator as you can use the cooking zone that is still hot.</p>	

5.3.3 Using the Boost function

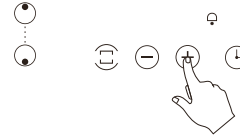
Activate the boost function	
<p>Boost is the highest power level, designed for quickly heating or boiling larger quantities. Boost will operate for maximum of 5 minutes. After 5 minutes, it will automatically revert to power level 9.</p>	
<p>Touching the "P/B" key will show on the display as a "P/B" boosting the heating power to the highest level.</p>	
	

If the display flashes alternately with the heat setting

This means that: You have not place a pan on the correct cooking zone or, the pan you are using is not suitable for the induction cooking or, the pan is too small or not properly centered on the cooking zone.

No heating takes place unless there is a suitable pan on the cooking zone.

5.3.4 Locking the controls

- You can lock the controls to prevent unintended use for example children accidentally turning the cooking zones on.
- When the controls are locked, all the controls except the ON/OFF control are disabled.



When the cooktop is in the lock mode, all the controls are disabled except the ON/OFF, you can always turn the induction cooktop off with the ON/OFF control in an emergency, but you shall unlock the cooktop first in the next operation

To lock the controls	
<p>Touch or hold the "Ⓛ" key for 2 seconds to activate the function. The unit will make a "beep" sound and the indicator light will turn on above the "Ⓛ" key. The controls are now locked.</p>	
To unlock the control	
<p>While in lock mode, Touch or hold the "Ⓛ" key for two seconds to deactivate the function. The indicator light will turn off.</p>	

cont. operation

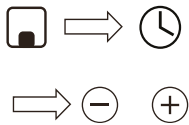
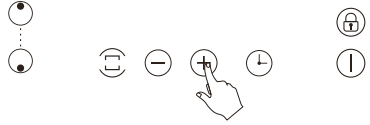
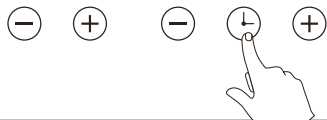

5.3.5 Timer control

You can use the timer in two different ways:

<p>With the desired heating zone Powered ON and flashing, press the "Time" key. The timer display will flash and show a "00" or "30", Press the "+" or "-" to increase or decrease to the desired time. Choose up to 99 minutes. Once the timer is set, timer starts if no other key is touch after 3 to 5 seconds, the timer display will flash and remain active for that particular cooking zone. When the time reaches "-" a "beeping" sound will go off indicating that the time is up, and selected heating zone shut off automatically.</p>	
<p>If you want to set another zone to switch-off automatically, choose the cooking zone and press "Time" key. Repeat the same steps above.</p>	
<p>If you want to check the remaining time for another cooking zone, press the cooking zone selector key, until the indicator for the desired burner flashes.</p>	
<p>If more than one switch - off time is programmed, the one with shortest remaining time will show on the display, the indicator for that particular zone will flash.</p>	
<p>Cancelling the timer: Choose the cooking zone key for the desired burners, then touch the "timer", then the timer of the selected cooking zone has been cancelled.</p>	

5.3.6 Flex zone (applicable on selected Models only/ Cannes, Dijon, Grenoble and Toulouse)

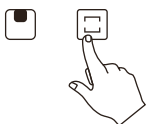
- This area can be used as a single zone or as two different zones, accordingly to the cooking needs anytime.
- Free area is made of two independent inductors that can be controlled separately.

<p style="text-align: center;">As a large flex zone</p>	
<p>To activate the free area as a large flex zone, simply touch the dedicated key. When the flex zone of the cooktop is flashing, press the  key, the indicator display read "5" flashes.</p>	
<p>Press the "P", "B", "-" key to increase or decrease the heating power.</p>	

As a large flex zone, we suggest the used as the follow:

Cookware: 250mm or 280 mm diameter cookware (Square or oval cookware are acceptable)

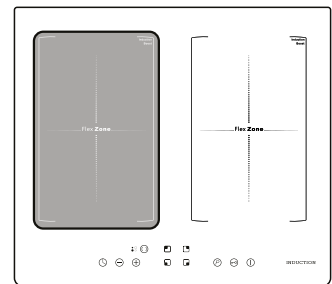
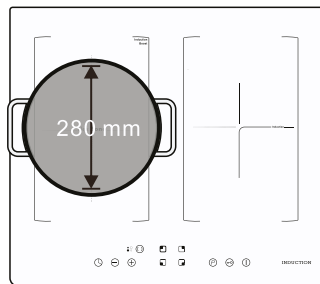
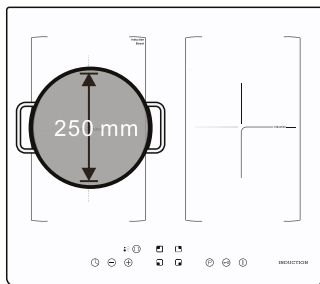

We don't recommend other except for above mentioned three operations because it might effect the heating off appliance

As two independent zones

- a. Put a pan on the right up side or the right down side of the large flexible zone.

- b. Put two pans on both sides of the large flexible zone.

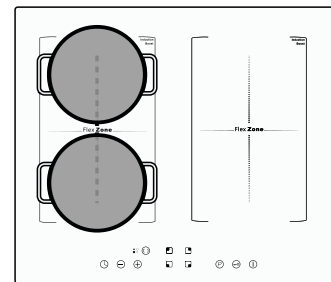
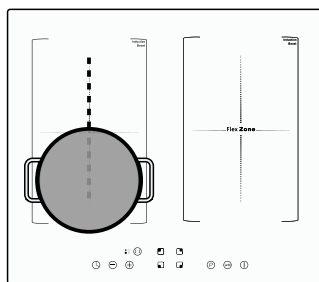
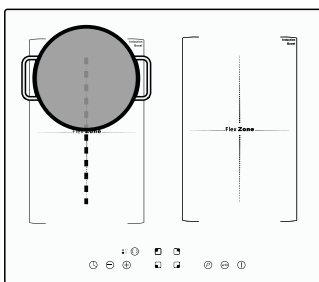

Notice: Make sure the pan is bigger than 12cm.

6. COOKING GUIDELINES



Take care when frying as oils and fats heat up very quickly, particularly if you are using PowerBoost. At extremely high temperatures oils and fats will ignite spontaneously and this presents a serious risk.

6.1 Cooking Tips

- Reduce the temperature when food is cooked or heated.
- Using a lid will reduce cooking times and save energy by retaining the heat.
- Minimize the amount of liquid or fat to reduce cooking times.
- Start cooking on a high setting and reduce the setting when the food has heated through.

6.1.1 Simmering, cooking rice

- Simmering occurs below boiling point, at around 85°C, when bubbles are just rising occasionally to the surface of cooking liquid. It is the key to delicious soups and tender stews because the flavours develop without overcooking the food. You should also cook egg-based and flour thickened sauces below boiling point.
- Some tasks, including cooking rice by the absorption method, may require a setting higher than the lowest setting to ensure the food is cooked properly in the time recommended.

6.2 Detection of small particles

- When an unsuitable size or non - magnetic pan (e.g. aluminum, or some other small item e.g. knife, fork, key) has been left on the cooktop, the cooktop automatically go on standby in 1 minute. The fan will keep cooking down the induction cooktop for a further 2 minutes.

6.1.2 Searing steak

To cook juicy flavoursome steak:

- Stand the meat at room temperature for about 20 minutes before cooking.
- Heat up a heavy - based frying pan.
- Brush both sides of the steak with oil, drizzle a small amount of oil into the hot pan and then lower the meat onto the hot pan.
- Turn the steak only once during cooking. The exact cooking time will depend on the thickness of the steak and how cooked you want it. Times may vary from about 2-8 minutes per side. Press the steak to gauge how cooked it is – the firmer feels the more 'well done' it will be.
- Leave the steak to rest on a warm plate for a few minutes to allow it to relax and become tender before serving.

6.1.3 For stir – frying

- Choose an induction compatible flat- based wok or a large frying pan.
- Have all the ingredients and equipment ready. Stir – frying should be quick. If cooking large quantities, cook the food in several smaller batches.
- Preheat the pan briefly and add two tablespoons of oil.
- Cook any meat first, put it aside and keep warm. stir- fry the vegetables. When they are hot but still crisp, turn the zone to a lower setting, return the meat to the pan and add your sauce.
- Stir the ingredients gently to make sure they are heated through.
- Serve immediately.

7. HEAT SETTINGS

The settings below are guidelines only. The exact setting will depend on several factor, including your cookware and the amount you are cooking. Experiment with the induction cooktop to find the settings that best suit you.

Heat setting	Suitability
1-2	<ul style="list-style-type: none"> • Delicate warming for small amount of food. • Melting chocolate, butter and foods that burn quickly. • Gentle simmering • Slow warming
3-4	<ul style="list-style-type: none"> • Reheating • Rapid simmering • Cooking rice
5-6	<ul style="list-style-type: none"> • Pancakes
7-8	<ul style="list-style-type: none"> • Sauteing • Cooking paste
9/P	<ul style="list-style-type: none"> • Stir - frying • Searing • Bringing soup to the boil • Boiling water

8. CARE AND CLEANING

Situation	What to do	Remarks
Everyday soiling on the glass. (fingerprints, marks stains left by food or non sugary spillovers on the glass)	<ol style="list-style-type: none"> 1. Switch the power of the cooktop OFF. 2. Apply a cooktop cleaner while the glass is still warm not hot. 3. Rinse and wipe dry with a clean cloth or paper towel. 4. Switch the power of the cooktop back ON. 	<ul style="list-style-type: none"> • When the power is switch off, there will be no “hot surface” indication but the cooking zone may still be hot! Take extreme care. • Always read the label to check if your cleaner is suitable. • Never leave cleaning residue on the cooktop; the glass may become stained.
Boilovers, melts and hot sugary spills on the glass.	<p>Remove these immediately with a fish slice, palette knife or razor blade scraper suitable for induction glass cooktops, but beware of hot cooking zone surfaces:</p> <ol style="list-style-type: none"> 1. Switch the power off the wall. 2. Hold the blade or utensils at a 30° angle and scrape off. 3. Clean the soiling or spill up with a dish cloth or paper towel. 4. Follow steps 2 to 4 for “Everyday soiling on glass” above. 	<ul style="list-style-type: none"> • Remove stains left by melts and sugary food or spillovers as soon as possible. If left to cool on the glass, they may be difficult to remove or even permanently damage the glass surface. • Cut hazard: when the safety cover is retracted, the blade in a scraper is razor-sharp. Use with extreme care and always store safely and out of reach of children.
Spillovers on the touch controls.	<ol style="list-style-type: none"> 1. Switch the power off. 2. Soak up the spill. 3. Wipe the touch control area with a clean damp sponge or cloth. 4. Wipe the area completely dry with a paper towel. 5. Switch the power back ON. 	<ul style="list-style-type: none"> • The cooktop may beep and turn itself off, and the touch controls may not function while there is liquid on them. Make sure you wipe the touch control dry enough before turning the cooktop back on.

9. TROUBLESHOOTING

Problem	Possible causes	Possible solution
The induction cooktop cannot be turned on.	No power.	Make sure the induction cooktop is connected to the power supply and the switch is on. Check whether there is a power outage in your area. After checking, and the problem persists, call a qualified technician.
The touch controls are unresponsive	The controls are locked.	Unlock the controls, See section “Using your induction cooktop” for instructions.
The touch controls are difficult to operate.	There maybe a slight film of the water over the controls or you may be using the tip of your finger when touching the controls.	Make sure the touch control area is dry and use the ball of your finger when touching the controls.
The glass is being scatched.	Rough - edged cookware. Unsuitable, abrasive scourer or cleaning products used.	Use cookware with flat and smooth bases. See “Choosing the right cookware”.
Some pans make crackling noises.	This may be caused by the construction of your cookware (layers of different metal vibrating differently).	This is normal for cookware and does not indicate fault.
The cooktop makes a humming noise when used on a high heat setting.	This is cause by the technology of induction cooking.	This is normal but the noise should be slowing down or disappear when you decrease the heat setting.
Fan noise coming from the cooktop.	A cooling fan built into your cooktop prevents the electronics from overheating.	This is normal and needs no action.
Pans is not heated and appears on the display.	Pan is suitable for induction cooking or it is too small for the cooking zone or it is not properly centered.	Use the cookware that is suitable for induction cooking. See “choosing the right cookware”.
The cooktop turned OFF unexpectedly. An error code is displayed.	Technical fault.	Please note down the error code, switch the power of the induction cooktop OFF at the wall, and contact a qualified technician.

cont. troubleshooting

The induction cooktop is equipped with a self-diagnostic function. With this test the technician is able to check the function of several components without disassembling or dismantling the cooktop from the working surface.

1. Failure code that occur when customer is using and Solution;

ERROR	CHECK POINTS		
Plug in, No "Bl" heard	- Is there blackouts? - Check for damaged fuse and socket.	*E4	- Check IGBT open for short-circuits.
*U	- Check if cooking vessel suits for the cooker. - Check if the pot is centered. - Check if the bottom diameter is not larger than 12cm.	*E5	- Surface temperature is higher than 280°C.
*E1	- Check for low voltage.	*E6	- Check ambient temperature if it is high. - Check suction and exhaust outlets and see if the fan is running. - Check under warm/ milk section if the set temperature has been reached. - Check the protective device if triggered or not. Wait for 10minutes to confirm.
*E2	- Check for high voltage.	*Er	- Signal problem between control pcb and main pcb.
*E3	- Check sensor open for short-circuits.		

*IGBT- insulated – gate bipolar transistor, A semiconductor device use to control the load of power supply.

2. Specific Failure and Solution

FAILURE	PROBLEM	SOLUTION
The LED does not turn on when unit is plugged in	No power supplied. Accessorial power board and display board failure. Accessorial power board is damaged. The display board is damaged.	Check if the outlet is working and tightly secure the plug. Check connection. Replace the accessorial power board. Replace the display board.
Some keys wont work, or LED display is not normal	The display board is damaged.	Replace the display board.
Heating suddenly stops and the display flashes " <u>U</u> ".	Pan type is wrong. Pot diameter is too small.	Use a proper pot. (refer to page 7) Pan detection circuit is damaged.
Cooking mode indicator comes on, but heating does not start.	High temperature of the cooktop. There is something wrong with the fan. The power board is damaged.	Ambient temperature may be too high. Air intake or air vents maybe blocked. Check if the fan is running smoothly. If not, replace the fan. Replace the power board
Heating zones of the same side (Such as the 1st and 2nd zone) would display "Er"	Power board and display board connection failure. Display board communication part is damaged. The main board is damaged.	Check connection. Replace the display board. Replace the power board.
Fan motor sounds is not normal	The fan motor is damaged.	Replace the fan.

 If you have completed the above check and still having difficulty, please contact your local Linarie Service Center. See "Warranty and Spare parts section".

GENERAL INFORMATION

- Allow the appliance to cool down completely before cleaning and maintenance.
- The surface and controls are susceptible to scratches and abrasion. Please observe the following cleaning instructions.

WARNING

Observe all safety and warning information during operation (see the "General Safety Instructions" section). Before maintenance or cleaning, the appliance should always be disconnected from the power supply. Make sure that the appliance is switch off and the plug has been removed. Exterior surfaces are prone to scratches and dents. Therefore, please follow the cleaning instructions to achieve the best possible result without damage.

10. ENVIRONMENTAL TIPS

Observe all safety and warning information during operation (see the "General Safety Instructions" section).

10.1 Disposal considerations

The transport and protective packaging has been selected from materials which are environmentally friendly for disposal, and can normally be recycled.

Recycling the packaging reduces the use of raw materials in the manufacturing process and also reduces the amount of waste in landfill sites. Ensure that any plastic wrappings, bags etc. are disposed of safely and kept out of the reach of babies and young children. Danger of suffocation.



10.2 Disposing of your old appliance

Electrical devices marked with this label may not be disposed of in domestic waste at the end of their service life.

Electrical and electronic appliances often contain valuable materials. They also contain specific materials, compounds and components, which were essential for their correct function and safety. These could be hazardous to human health and to the environment if disposed of with your domestic waste or if handled incorrectly. Please do not, therefore, dispose of your old appliance with your household waste.

Please dispose of those materials by contacting your local authorities and ask for the correct method of disposal. Please ensure that your old appliance poses no risk to children while being stored prior to disposal.

By disposing of this product in accordance with the regulations, you protect the environment and the health of those around you from negative consequences.

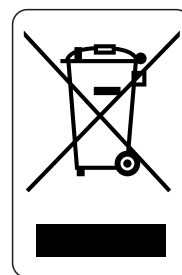

11. WARRANTY & AFTER SALES SERVICE

Observe all safety and warning information during operation (see the "General Safety Instructions" section).

In the event of a fault which you cannot remedy yourself, please contact Linärie.

11.1 Warranty

The manufacturer's warranty for this appliance is 2 years.

11.2 After sales service

The contact details for Linärie are given at the beginning and of these instructions.

When contacting Linärie, please quote the model and serial number of your appliance. These can be found on the data plate, after removing the grease filter.

Record model & serial number

Model:.....

Serial Number:.....

Register your product www.linarie.com.au

11.3 Replacement of spare parts

Incorrect components can lead to personal injury or damage to the appliance. Use only genuine original Linärie spare parts.



Modifications, additions or alterations to the appliance can lead to safety risks. If spare parts or accessories from other manufacturers are used, the warranty will be invalidated, and Linärie cannot accept liability.

Please check www.linarie.com.au for more information.

LIKE TO KNOW MORE?

For further information on all Linärie appliances,
or to obtain detailed dimension and installation
information, phone or email our Customer Care
team or visit our website:

Australia
hello@linarie.com.au
www.linarie.com.au

Follow Us
[@Linarie.Appliances](#)
  

© Linärie

Operating and installation instructions:

Original

√ Translation

Mart Online Services Pty Ltd.
ACN 657 824 050

Linärie Contact
hello@linarie.com.au
www.linarie.com.au

The distribution and duplication of this document, as well as the use and disclosure of its contents are prohibited unless expressly authorised.

These operating and installation instructions have been drawn up with the greatest of care. But it cannot be ruled out that subsequent technical modifications have not yet been incorporated or the relevant content has not yet been adapted. Please accept our apologies in this eventuality. An updated version can be requested from our team. Subject to printing errors and mistakes.

© Linärie

All rights reserved.