

Foreword

This supplement contains explanations and instructions for correctly operating the following systems.

- Navigation System
- Audio and Visual System
- Handsfree System
- APPS

If your vehicle contains one of the systems above, be sure to check the contents of this supplement carefully.

If you transfer the ownership of the vehicle to another person, make sure that this supplement is provided with the Owner's Manual inside the vehicle.

The information, specifications and illustrations in this supplement are valid at the time of publication. SUBARU CORPORATION reserves the right to change the specifications and design without prior notice, with no obligation to perform the same or equivalent changes to vehicles sold in the past.

This Owner's Manual supplement applies to all models, and describes all devices, including manufacturer-installed options. This means that information may be included about devices that are not installed in your vehicle.

Refer to P.14 for details on each of the different models.

SUBARU
STARLINK

SUBARU STARLINK is the "in-car connectivity system" available on select Subaru vehicles.

SUBARU CORPORATION, TOKYO, JAPAN

"SUBARU" and the six-star cluster design are registered trademarks of SUBARU CORPORATION.

©Copyright 2022, SUBARU CORPORATION

TABLE OF CONTENTS

1 Quick Guide

2 Basic Function

3 Settings

4 Phone

5 Apps

6 Audio

7 Navigation System (8-inch with Navi system only)

8 Siri/Voice Recognition System

9 Appendix / What To Do If / Index

· System Types... 14 · Main Product Features... 16 · Overview Buttons... 18 · Home Screen... 19
· Steering Wheel Controls... 30

13

· Basic Information Before Operation... 32 · Rear View Camera... 43

31

· Registering A Bluetooth Phone/Device For The First Time... 52 · Registering A Bluetooth Phone/Device... 56
· General Settings... 63 · Sound Settings... 77 · Vehicle Customization... 80 · Clock Settings... 82

51

· Calling On The Bluetooth Phone... 90 · Receiving On The Bluetooth Phone... 94
· Talking On The Bluetooth Phone... 95 · Bluetooth Phone Message Function... 97

85

· SUBARU STARLINK... 107 · aha™... 112 · Pandora®*... 116 · Apple CarPlay... 119 · Android Auto... 121
· SiriusXM Travel Link... 123 · "SUBARU STARLINK Safety and Security"...See "SUBARU STARLINK Safety and Security" Owner's Manual

103

· Basic Operation... 128 · Radio Operation... 132 · Media Operation... 149 · Audio Remote Controls... 161

127

· Basic Operation... 172 · Destination Search... 182 · Route Guidance... 190 · Setup... 197
· SUBARU Map Update... 201

171

· Siri... 210 · Voice Recognition System Operation... 213

209

· Troubleshooting... 230 · Index... 247

221

*: Pandora is only available in certain countries. Please visit pandora.com/legal for more information.

INTRODUCTION

The symbols described below are found in this instruction manual as well as on the unit itself to ensure its proper and safe usage and to prevent injury or damage to property. Make sure you understand the meaning of these symbols before reading the rest of this manual.

READ FIRST

We recommend that you wait until the positioning stabilizes before starting to drive.

If you start to drive while the positioning is not complete, the indicated position may differ from the actual vehicle position.

The screens shown in this manual may differ from the actual screens depending on the data type or when the map data was created.

When maps are created, land surveys are conducted and information on road improvements and reopening is collected to provide the most accurate information possible. However, modifications to roads, place names and facilities may be carried out at any time. Consequently, we cannot guarantee that map data contains no errors in road positions, configuration and names, or in facility names.

Information in this manual that must be observed for the unit, and information that is useful to know is indicated as follows.

WARNING

- This sign indicates a situation in which incorrect handling through disregard of written information might result in death or serious personal injury.

CAUTION

- This sign indicates a situation in which incorrect handling through disregard of written information might result in personal injury or damage to property.

NOTE

- Useful information for the user is described.
- Be sure to read all materials such as manuals and warranties that come with the product. SUBARU CORPORATION is not responsible for problems that arise due to failure to follow these instructions.
- Changes to product specifications may result in differences between the content of the manual and the features of the unit.

SYMBOLS USED IN ILLUSTRATIONS

Safety symbol



The symbol of a circle with a slash through it means “Do not”, “Do not do this” or “Do not let this happen”.

Arrows indicating operations

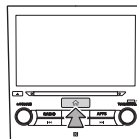

Indicates the action (pressing, turning, etc.) used to operate switches and other devices.

PRECAUTIONS FOR USE

WARNING

- The main unit requires a 12 V DC power supply. The main unit should not be installed in any vehicle which does not have a 12 V power system with a ground-connected negative side. An installation other than the one intended may cause severe damage to the main unit, and electric shock or serious injury to the users.
- Even when using the route guidance of the navigation system, be sure to drive by following the actual traffic regulations. If you drive by following only the route guidance of the navigation system, you may violate the actual traffic regulations and cause a traffic accident.
- To ensure safety, the driver should not operate the navigation system while driving. Operating the navigation system while driving may result in an accidental steering wheel operation or otherwise cause an accident. Stop the vehicle before operating the navigation system. Also, do not watch the screen while driving because doing so may be dangerous (ETC). Inattention to road conditions ahead may result in an accident.
- The driver should not perform operations such as volume adjustment while driving. Inattention to road conditions ahead may result in an accident, so be sure to stop the vehicle in a safe place before performing the operation.

- The driver should not change discs while driving. Inattention to road conditions ahead may result in an accident, so be sure to stop the vehicle in a safe place before performing the operation.
- The driver should not perform operations such as adding a location or setting the memory while driving. Inattention to road conditions ahead may result in an accident, so be sure to stop the vehicle in a safe place before performing the operation.
- Before viewing a video, be sure to stop the vehicle in a safe place and apply the parking brake. To ensure safety, videos are not displayed during driving.
- To ensure safety, never operate a cell phone while driving.
- Do not let foreign objects enter the disc slot. Doing so may result in a fire or electric shock.
- Do not disassemble or modify the unit. Doing so may result in an accident, fire or electric shock.
- Do not let water or foreign objects enter the internal parts of the unit. Doing so may result in smoke, fire or an electric shock.
- Do not use the unit when it is malfunctioning, such as when the screen is not lit or no sound comes out. Doing so may result in an accident, fire or electric shock.
- Always replace fuses with fuses of the same specified capacity (amperage). Using a fuse with a higher capacity than the specification may result in a fire.

- If a foreign object or water enters the unit, smoke or a strange odor may be emitted. If such an abnormality occurs, stop using the unit immediately and contact your SUBARU dealer. An accident, fire or electric shock may result if you continue to use the unit under these conditions.
- In a thunderstorm, do not touch the antenna line or the unit. Lightning may cause an electric shock.
- Do not park or stop in prohibited areas to use the unit.
- If direct sunlight shines into the vehicle, light may reflect off the product. Be very careful while driving.
- Never use headphones or earphones while driving. Driving while not being able to hear sounds from outside the vehicle may result in a traffic accident.
- Do not remove the SUBARU genuine navigation and/or audio system. If the SUBARU genuine navigation and/or audio system is removed, the rear view camera image and help lines (distance marker, dynamic guidelines and vehicle width lines) will no longer be displayed.
 - For some models with Reverse Automatic Braking, even if the Reverse Automatic Braking and object detection warning is ON, the visible alert of Reverse Automatic Braking will not be displayed. However, the audible alert and its function will operate.

CAUTION

- Although the unit can be used when the ignition switch is set to either "ACC" or "ON" position, to protect the battery, start the engine before using the unit.
- Do not use the unit anywhere other than in a vehicle. Doing so may result in an electric shock or other injury.
- While driving, keep the volume low enough for you to hear outside sounds. Driving while not being able to hear sounds from outside the vehicle may result in an accident.
- Be careful of the volume when turning on the power. If a loud noise is emitted suddenly when you turn on the power, it may damage your hearing.
- Do not apply a strong force to the display. Doing so may result in a malfunction.
- Do not put your fingers or hands into the disc slot. Doing so may result in an injury.
- Do not touch the hot parts of the unit. The hot parts may burn you.
- Do not use while there is an abnormality such as sound breakup or distortion. Doing so may result in a fire.
- Using the unit during extremely high or low temperature may result in mistaken operation or a malfunction. In particular, the temperature inside the vehicle can often rise to a high level during the summer. Cool the vehicle, for example by opening a window, before using the unit.
- Be careful if metal or water enters the unit, or the unit is exposed to a strong impact, because it may result in a malfunction.

- The touch buttons on the display screen may not operate correctly if condensation forms inside them. If this happens, do not attempt to operate the switches until the condensation has disappeared.
- If juice or similar liquid is spilled on the display, wipe off immediately. Failure to do so may result in product malfunction.
- The screen is easily marked by fingerprints and tends to attract dust, and should therefore be cleaned occasionally. When cleaning, turn off the power, and wipe lightly with a soft, dry cloth. To remove dirt, soak a soft cloth in neutral detergent and squeeze well before wiping. Do not use a wet floor-cloth, organic solvents (benzene, ethanol, thinner, etc.), acids, or alkalis. Using such agents will result in screen deterioration. Furthermore, do not hit the screen or rub it with hard objects.

NOTE

- SUBARU CORPORATION is not responsible for any damages to the purchaser or third parties that occur from using the map data.
- We do not provide any replacements or refunds for any mistakes there may be in the map data displays or contents, such as misspelling, omissions or misaligned positions.
- SUBARU CORPORATION makes no guarantee that the functions included in the map data will be appropriate for the specific objectives of the purchaser.
- Functions that cannot be operated while driving have their colors toned down when the vehicle is being driven, and their operation is disabled. Touching a disabled switch may result in the display of an operation prohibited message on the screen.
- During strong vibrations, such as when driving on a poor road surface, the unit may no longer be able to read the data from the disc, and it will not operate correctly. When the vibration lessens, normal operation will return after a short time.
- Immediately after turning on the heater when the temperature is low, dew (water drops) may adhere to the lens of the CD reader (condensation). If this happens, leaving the unit for about an hour should remove the condensation and return the unit to normal operation.
If the unit does not return to normal operation even after several hours, contact your SUBARU dealer.
- When using the unit for the first time after purchase, or after the battery was removed for a long time, the current position may not be displayed correctly. Wait a short time until the GPS positioning corrects the displayed position.

NOTE

- This device is precision-engineered equipment and the recorded data can be lost as a result of static electricity, electrical noise, vibration, or other influences. To protect the device against data loss, we recommend keeping a separate record of the data that you record after purchase.
- The screen may be adversely affected or disturbed by noise if electrical equipment that generates powerful electrical noise is used near the system. In such cases, keep the electrical equipment at a distance, or refrain from use.
- The display may appear brighter when the temperature is low, or immediately after starting the engine, however, this is a characteristic of the LED elements, and does not indicate a fault. The display will return to its original brightness when the vehicle cabin has warmed up.
- When you look at the screen through polarized material such as polarized sunglasses, the screen may be dark and hard to see. If so, look at the screen from different angles, adjust the screen settings on the general settings screen or take off your sunglasses.
- It may be difficult to view the screen if the display is exposed to sunlight from an awkward angle.
- The LCD screen may not function normally if covered with a protective film. Do not affix a protective film.
- The touch panel may function incorrectly or fail to respond if operated with objects other than fingers (nails, operation when wearing gloves, pens, etc.)
- When inserting or removing CDs, take care not to touch the touch panel. The touch panel will respond if inadvertently touched by hand.

NOTE

- If the system functions unexpectedly such as an area other than the one touched being selected, or failure to respond when touched, there is a possibility that another finger or part of the hand is in contact with display.
- Scratches on the system panel surface are easily noticeable, and it should therefore be handled with care.

SAFETY INSTRUCTION (8-inch system only)



To use this system in the safest possible manner, follow all the safety tips shown below.

Do not use any feature of this system to the extent it becomes a distraction and prevents safe driving. The first priority while driving should always be the safe operation of the vehicle. While driving, be sure to observe all traffic regulations.

Prior to the actual use of this system, learn how to use it and become thoroughly familiar with it. Read the entire manual to make sure you understand the system. Do not allow other people to use this system until they have read and understood the instructions in this manual.

For your safety, some functions may become inoperable when driving. Unavailable screen buttons are dimmed.

! WARNING

- For safety, the driver should not operate the system while he/she is driving. Insufficient attention to the road and traffic may cause an accident.

SAFETY INSTRUCTION (8-inch with Navi system only)

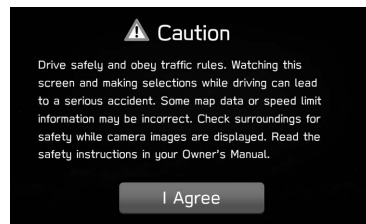

To use this system in the safest possible manner, follow all the safety tips shown below.

This system is intended to assist in reaching the destination and, if used properly, can do so. The driver is solely responsible for the safe operation of your vehicle and the safety of your passengers.

Do not use any feature of this system to the extent it becomes a distraction and prevents safe driving. The first priority while driving should always be the safe operation of the vehicle. While driving, be sure to observe all traffic regulations.

Prior to the actual use of this system, learn how to use it and become thoroughly familiar with it. Read the entire manual to make sure you understand the system. Do not allow other people to use this system until they have read and understood the instructions in this manual.

For your safety, some functions may become inoperable when driving. Unavailable screen buttons are dimmed. Only when the vehicle is not moving, can the destination and route selection be done.

WARNING

- For safety, the driver should not operate the system while he/she is driving. Insufficient attention to the road and traffic may cause an accident.
- While driving, be sure to obey the traffic regulations and maintain awareness of the road conditions. If a traffic sign on the road has been changed, route guidance may not have the updated information such as the direction of a one way street.

While driving, listen to the voice instructions as much as possible and glance at the screen briefly and only when it is safe. However, do not totally rely on voice guidance. Use it just for reference. If the system cannot determine the current position correctly, there is a possibility of incorrect, late, or non-voice guidance.

The data in the system may occasionally be incomplete. Road conditions, including driving restrictions (no left turns, street closures, etc.) frequently change. Therefore, before following any instructions from the system, look to see whether the instruction can be done safely and legally.

This system cannot warn about such things as the safety of an area, condition of streets, and availability of emergency services. If unsure about the safety of an area, do not drive into it. Under no circumstances is this system a substitute for the driver's personal judgement.

Use this system only in locations where it is legal to do so. Some states/provinces may have laws prohibiting the use of video and navigation screens next to the driver.

HOW TO READ THIS MANUAL

Bluetooth® SETTINGS

► When setting the Bluetooth phone/device

4. Select the desired Bluetooth phone/device.
5. Select the item to be set.

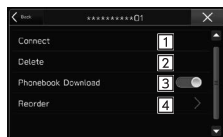

No.	Function	Page
1	Connecting or disconnecting Bluetooth phones/devices	58
2	Deleting Bluetooth phones/devices	60
3	Setting phonebook download	61
4	Setting the automatic connection priority	62

NOTE

- The phone settings screen can also be displayed by selecting **Change Device** (Change Device) on the phone overview screen (→P.86) or Bluetooth audio operation screen (→P.156).

REGISTERING A Bluetooth PHONE/DEVICE

Up to 5 Bluetooth phones/devices can be registered.

Bluetooth compatible phones (HFP) and devices (AVP) can be registered simultaneously.

This operation cannot be performed while driving.

1. Display the phone settings screen. (→P.55)
2. Select **Add Device** (Add Device).



- If a message appears, follow the guidance on the screen.

No.	Name	Description
1	Operational Outlines	An outline of the operation is explained.
2	Main Operations	The steps of an operation are explained.
3	Supplemental information	Describes supplemental information relating to main operation.

- When a panel button should be selected, button names are shown as **○○○**.
- When a touch button on the screen should be selected, button names are shown as **○○○**.



Quick Guide



System Types	14
Main Product Features	16
Basic Function	18
Overview Buttons	18
Home Screen	19
“Phone” Screen	20
“Map” Screen	22
“Radio” Screen	24
“Media” Screen	25
“Apps” Screen	26
“Settings” Screen	28
Steering Wheel Controls	30
Steering Wheel Controls	30

SYSTEM TYPES

This manual describes the following two operation methods.

Note that all of the descriptions in the manual are based on the 8-inch with Navigation system.

8-inch system

Features: - 8-inch touch screen
- **PHONE** button

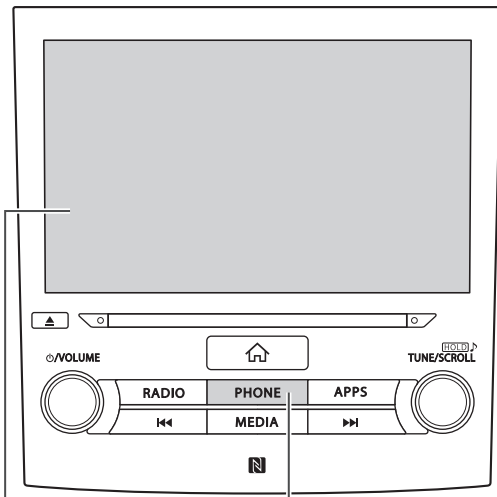

8-inch touch screen

PHONE button

» MAIN FUNCTIONS

Function	Page
Pairing (Bluetooth 3.0)	20
Apps	26
Apple CarPlay	119
Android Auto	121
AM/FM radio	24
HD Radio receiver	134
SiriusXM® satellite radio	138
Media operation	CD:149 USB:151 iPod:153 Bluetooth audio:156 AUX:159
Phone	20
Voice recognition system	213
NFC	56
Steering wheel controls	30
Rear view camera	43

8-inch with Navi system

- Features: - 8-inch touch screen
- **MAP** button

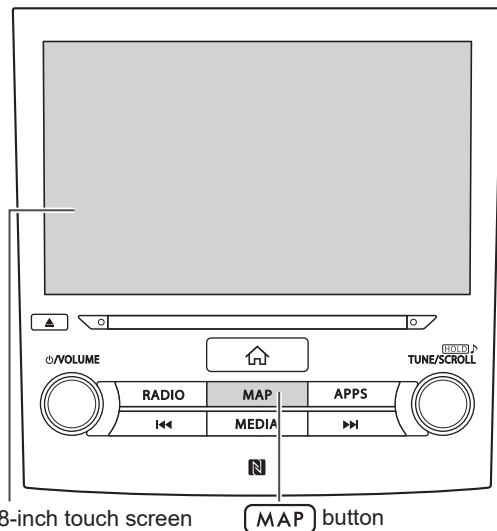

» MAIN FUNCTIONS

Function	Page
Pairing (Bluetooth 3.0)	20
Navigation system	22
Apps	26
Apple CarPlay	119
Android Auto	121
AM/FM radio	24
HD Radio receiver	134
SiriusXM® satellite radio	138
Media operation	CD:149 USB:151 iPod:153 Bluetooth audio:156 AUX:159
Phone	20
Voice recognition system	213
NFC	56
Steering wheel controls	30
Rear view camera	43

MAIN PRODUCT FEATURES

Adoption of intuitive and easy-to-use smartphone-like graphical user interface



STANDARDIZED OPERATION SCREEN LAYOUT FOR ALL FUNCTIONS

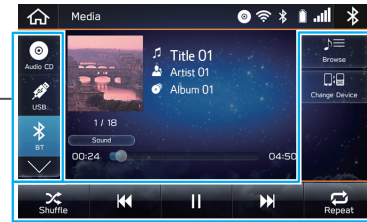

Mode switching buttons, etc. Operation buttons, etc.

Mode switching buttons on the left and operation buttons on the right and at the bottom prevents users becoming lost in operation no matter which functions are used.

USE OF POP-UP SCREENS

Close pop-up screen to return to original screen

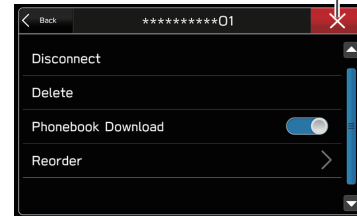

Pop-up screens are used instead of screen switching, preventing users from losing the current screen.

Easy-to-view map screen display* P.173

Maps appear wider by minimizing constantly displayed buttons.

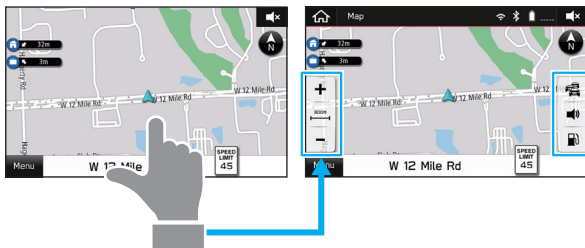

Touch screen to display automatically hidden buttons.

Rough destination search function* P.183

Start a search with a variety of words such as addresses, facility names, intersection names, or latitude/longitude.

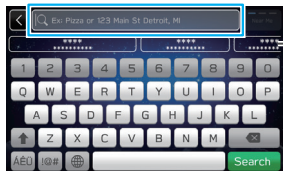

Displays search prediction

- Search results are predicted and candidates displayed even if only partial words are known
- Searches can even be performed with multiple keywords.

*: 8-inch with Navi system only

Customized home screen layout P.40

Frequently used functions and operations can be added to the home screen.



Example: For calling specific phone numbers, listening to specific radio stations, etc.

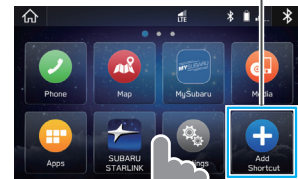

Button positions can be changed freely.

System and Bluetooth phone / device pairing P.20

Functions such as hands-free and applications can be used by connecting the system with Bluetooth phones / devices wirelessly.



Apple CarPlay / Android Auto

Support for Apple CarPlay and Android Auto allows access to functions such as maps, phone calls, and music.

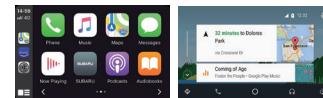

P.119

P.121

BASIC FUNCTION

OVERVIEW BUTTONS

TOUCH SCREEN

Operations are performed by touching the touch screen directly with your finger. P.34

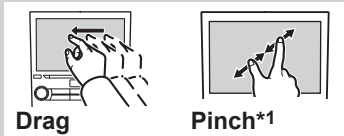

Press to eject a disc. P.33



Turn the knob to adjust the volume.



Press the knob to turn the volume mute on/off and pause playback of cache radio and other media devices.

Press and hold to turn the audio system off, and press to turn it on again.

Press and hold the knob for 10 seconds or longer to reset the system if the touch screen becomes unresponsive during operation or if any other system error occurs.

Insert a disc into this slot. The CD player turns on immediately. P.33

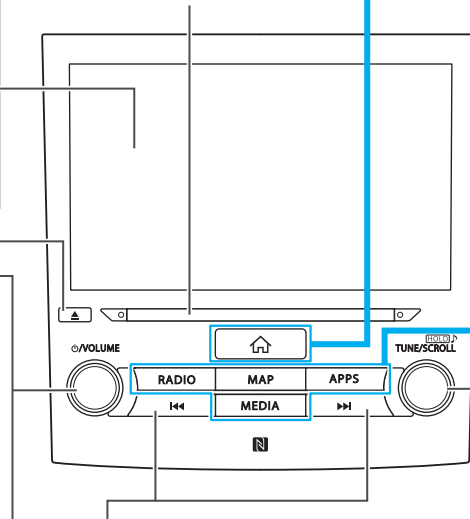

Press button to seek up or down for a radio station or to access a desired track/file.

Press and hold button to fast forward/rewind files or tracks.

Radio P.132,138 CD P.149

USB P.151 iPod P.153 Bluetooth audio P.156

Displays the home screen

Shortcut to each screen

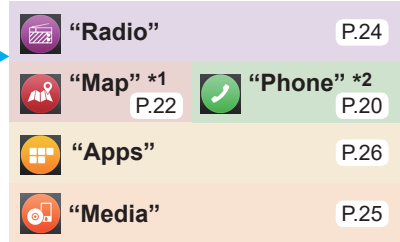

Audio operation screen:



Turn the knob to select a radio station or skip to the next or previous track/file.



Press and hold the knob to display the sound settings screen. P.78

List display screen:



Turn the knob to move the cursor.



Press the knob to select the item selected with the cursor.

*1: 8-inch with Navi system only
*2: 8-inch system only

HOME SCREEN

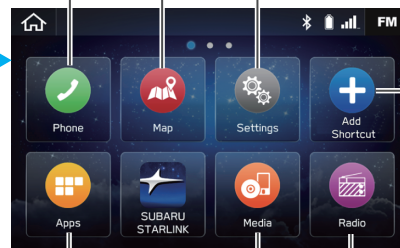
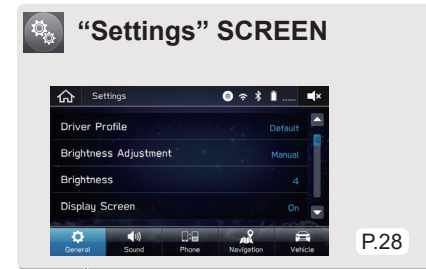
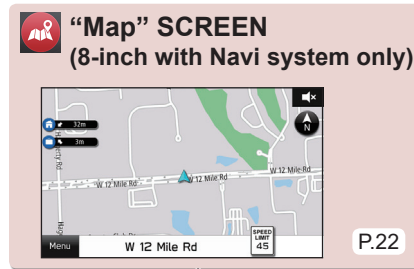
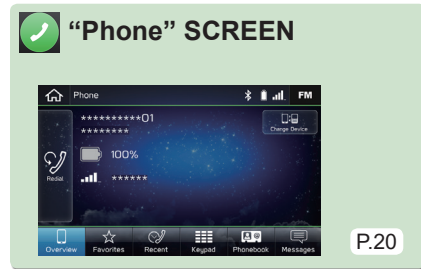

Frequently used functions and operations can be added to the home screen. P.40

Button positions can be changed freely. P.41

By connecting an iPhone or Android device to the USB port, a CarPlay or Android Auto icon will display on the home screen.

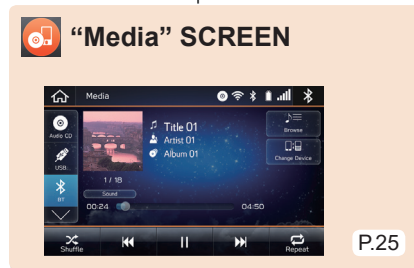
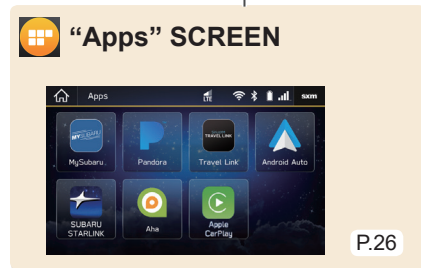

“Phone” SCREEN

Call or send a text message to a registered favorite
P.92,101

Call or send a text message to a recent contact P.92,101



Call or send a text message to a contact in the phonebook on the Bluetooth connected phone P.93,101

Check or reply to messages/place calls from received message list P.99,100,102

Directly input a number to place a call P.93

- Operation Flow: Pairing the System with a Bluetooth Phone/Device -

» Display the “Phone” screen.

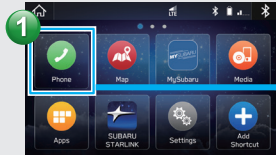

Prepare the Bluetooth phone/device to be paired.

» Operate the Bluetooth phone/device.

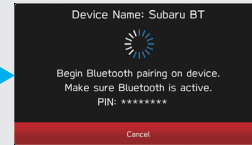
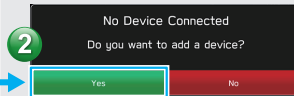

Turn the Bluetooth phone/device Bluetooth function ON and select “Subaru BT”. If registering an NFC compatible device, hold it against the NFC logo of the audio system until a connection is established.

» Register the Bluetooth phone/device.

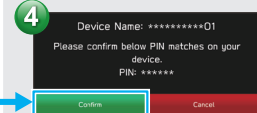

If unable to pair, check whether your Bluetooth phone/device is compatible with the system.

- Operation Flow: Placing Calls/Sending Messages from the Phonebook -

» Select call recipient from phonebook.



If unable to select the button, the setting for downloading the phonebook for the Bluetooth phone may be OFF. P.61

» Select number for making call/sending message.

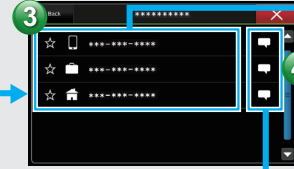

Place call

Send message

» Select message.



» Send message.

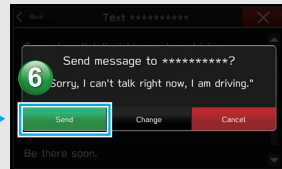

» In-call screen is displayed.

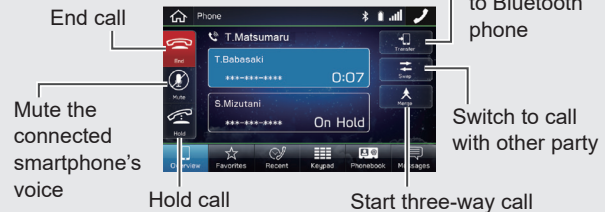

In-call screen display and operation may differ, or may not be possible depending on the Bluetooth phone used.

“Map” SCREEN (8-inch with Navi system only)

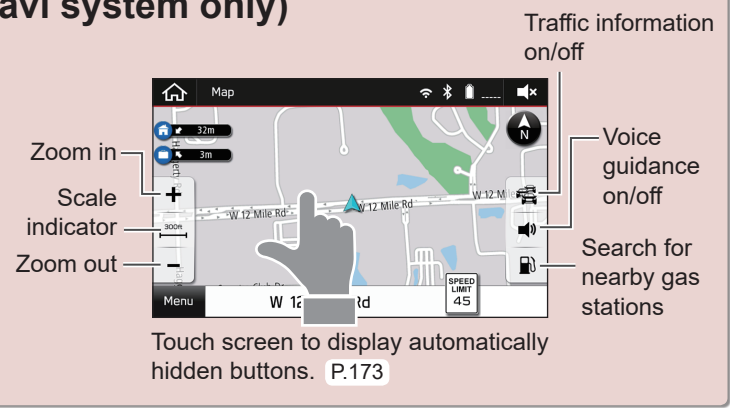
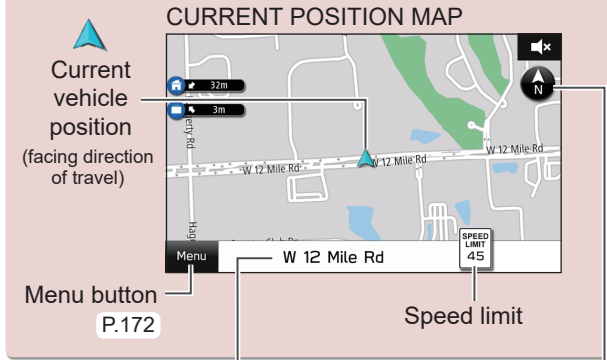

Current street
Touch the current street name to display details of the current location, allowing that location to be registered.



The orientation of the map can be changed between 2D north-up, 2D heading-up and 3D. P.175



2D North-up screen 2D Heading-up screen 3D screen

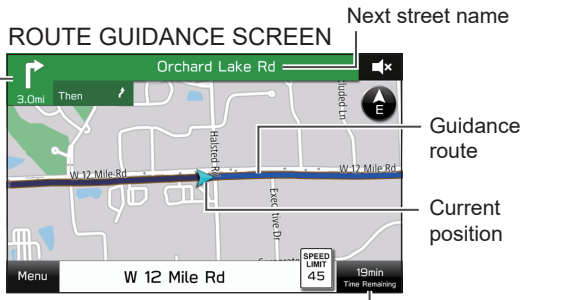

Distance to the next turn and an arrow indicating the turning direction
Remaining time/remaining distance/estimated arrival time
Destination search P.182
Route guidance P.190

- Operation Flow: Route Guidance -

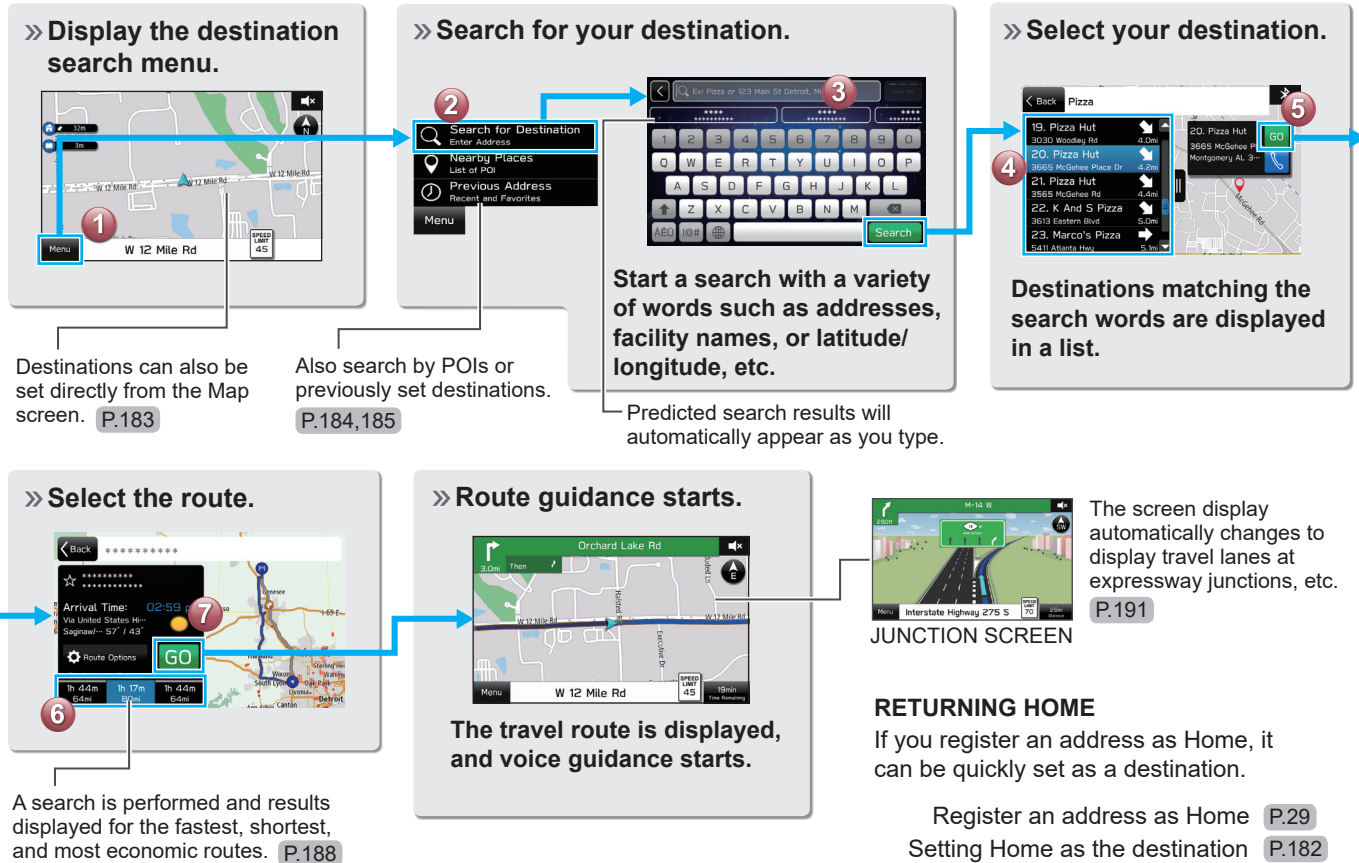



“Radio” SCREEN

Select to adjust the sound settings. P.130

Change radio mode



Preset stations/channels

Select to scan for receivable stations/channels.

Select to turn HD Radio mode on/off (AM/FM). P.134

PAUSE AND PLAYBACK LIVE RADIO

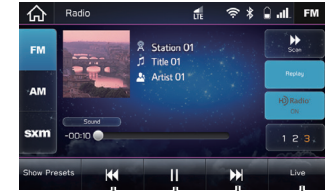

Previous Next
Pause/play Current program

Radio programs can be temporarily saved and played back later. P.136

- Operation Flow: Presetting a Radio Station -

» Select the radio band.



1

A valid subscription to SiriusXM® Satellite Radio is required to receive satellite radio service.

» Select the radio station.



2

Scan

OR



3

Press to seek for a station/channel.

» Register the radio station.



4

Mix preset function
Multiple stations can be registered as presets. (AM, FM or SiriusXM® Satellite Radio) P.134,142

Select and hold one of the screen buttons.





“Media” SCREEN

Select to adjust the sound settings. P.130

Playback tracks and programs, etc.
in a variety of playback modes

Change
media source

Random
playback on/off

Change tracks

Select and hold to fast rewind

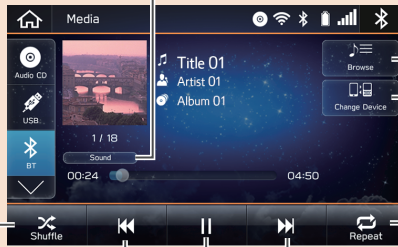

Pause/play

Change tracks

Select and hold to fast forward

Change to other
Bluetooth audio device/
register new device

Repeat current track →
repeat current album/
folder → cancel repeat

SUPPORTED MEDIA

CD P.165

USB/iPhone/iPod P.168

Bluetooth audio P.53

- Operation Flow: Using Playback Modes -

» Display the playback
mode list.

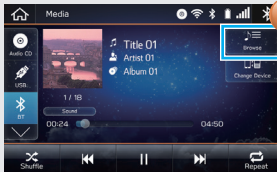

» Select the playback mode.

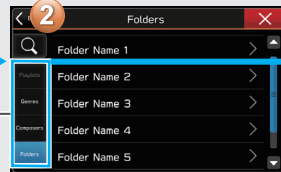

Depending on the audio source, several
items from these categories are displayed
in a list.

» Play a track.

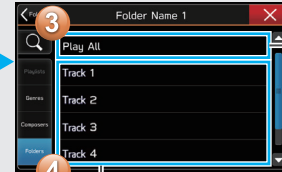

Play all tracks from
the selected
category.

Play the selected track.

“Apps” SCREEN

List of usable applications

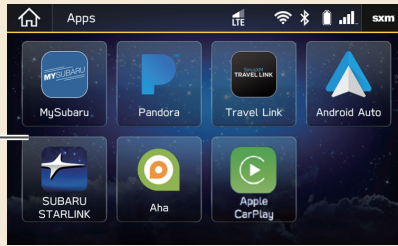

ABOUT USING APPLICATIONS

In order to use an application on this system, the corresponding application must be installed on your smartphone. P.104

Apple CarPlay does not require an application to be installed.



Pandora*1

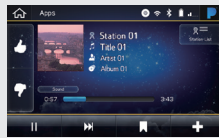

Pandora is free personalized radio that offers effortless and endless music enjoyment and discovery. P.116

*1: Pandora is only available in certain countries. Please visit pandora.com/legal for more information.



aha™



aha™ is a cloud-based application that connects to the system and gives you access to your favorite web content safely and easily. P.112



SUBARU STARLINK

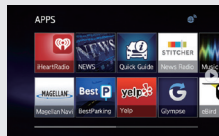

The SUBARU STARLINK function allows the system to link with a smartphone. P.107



MySubaru*2

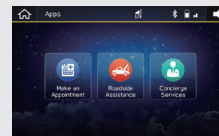

Access SUBARU STARLINK “SUBARU STARLINK Safety and Security” for a variety of remote services. Refer to the “SUBARU STARLINK Safety and Security” Owner’s Manual for details.

*2: Only in vehicles with “SUBARU STARLINK Safety and Security”



Apple CarPlay

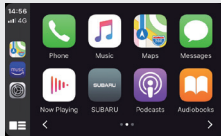

CarPlay can be used to view iPhone maps, play music, and place calls by connecting your iPhone to the system. Supported applications can also be run.

P.119



Android Auto

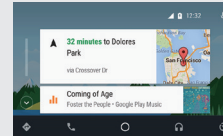

Android Auto can be used to view Android maps, play music, and place calls by connecting your Android device to the system. Supported applications can also be run. P.121



SiriusXM Travel Link

SiriusXM Travel Link is a service provided by SiriusXM® Satellite Radio, and can be used to view information on fuel information, sports, stocks, and weather.

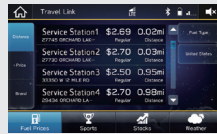

Fuel information



Sports

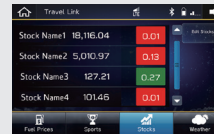

Stocks



Weather

P.123

8-inch with Navi system: Weather information can be viewed by linking with the navigation function.

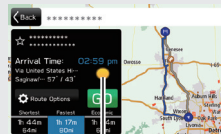

Weather information

Current weather information for your destination can be viewed at the route calculation screen. P.188



Weather information broadcast by weather stations en route to your destination can be viewed during route guidance. P.196

SiriusXM Travel Link subscription is required.

“Settings” SCREEN

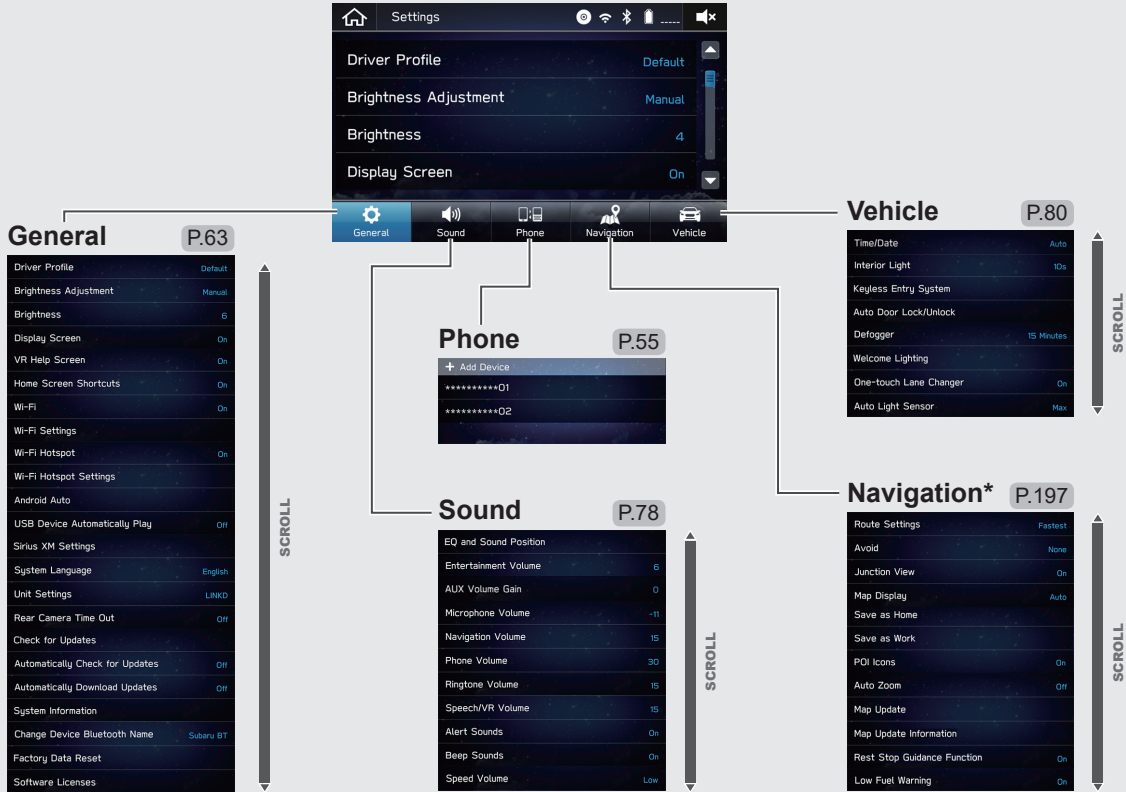

*: 8-inch with Navi system only

- Operation Flow: Create a driver profile -

CREATE A DRIVER PROFILE

Create a driver profile and register your cellular phone, address, etc. You can store and call registered information at any time.

» Add a new profile.

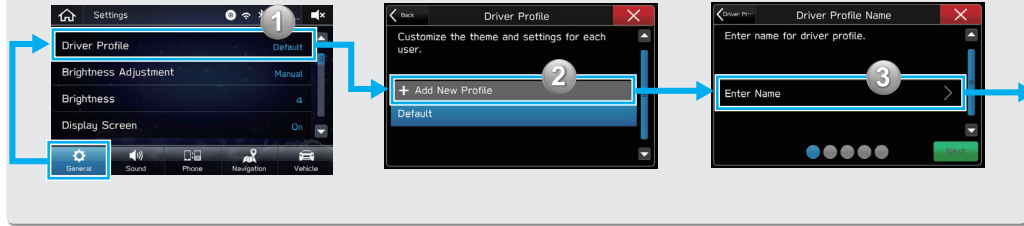

Enter a name.

» Registering a Bluetooth phone

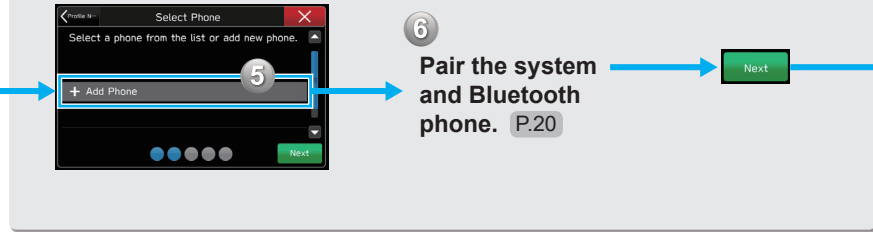

Pair the system and Bluetooth phone. P.20

» Register your home/office.*

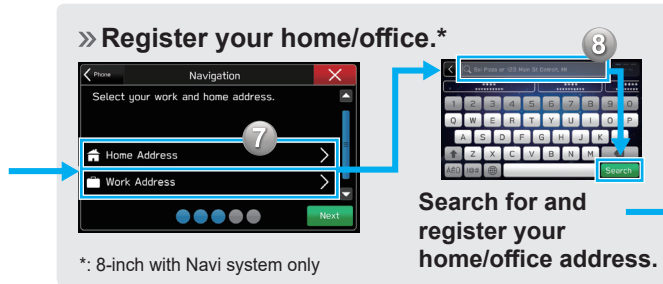

*: 8-inch with Navi system only

» Register wallpaper.



Procedure complete.

STEERING WHEEL CONTROLS

STEERING WHEEL CONTROLS

Some parts of the audio system can be controlled using the steering wheel controls.

P.161

RADIO

Press: Preset station/channel up/down

Press and hold: Scan and stop at the first received station when the switch is released

MEDIA

Press: Change a track/file

Press and hold: Fast forward/rewind

Press: Volume up/down

Press and hold: Volume up/down continuously

Press the switch to change audio sources between radio modes and media modes.

Press: Start the voice recognition system*1 P.213

Press and hold: Start Siri*2 P.210

*1: The system's voice recognition function cannot be used while using Siri, Apple CarPlay or Android Auto. Start the voice recognition function after exiting Siri, Apple CarPlay or Android Auto.

*2: If connected to iPhone

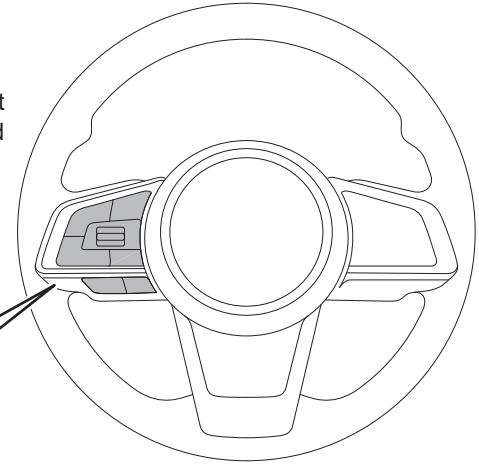
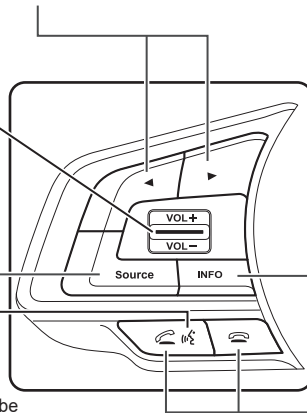

Operate the multi function display. See vehicle Owner's Manual.

Press the switch to receive/end a call without taking your hands off the steering wheel. P.88

2

Basic Function



Basic Information Before Operation	32
Initial Screen	32
Initial Screen	32
Loading And Unloading A Disc	33
Loading A Disc	33
Unloading A Disc	33
Connecting And Disconnecting	
A USB Memory Device/Portable Device	34
Connecting A Device	34
Touch Screen Gestures	34
Touch Screen Operation	36
Entering Letters And Numbers/	
List Screen Operation	37
Entering Letters And Numbers	37
List Screen Operation	38

Screen Adjustment	39
Adjusting Brightness	39
Changing Between Day And Night Mode	39
Status Display	39
Home Screen Operation	40
Adding Shortcut Icons To The Home Screen	40
Moving And Deleting Shortcut Icons	41
Sirius XM Weather Alert	42

Rear View Camera	43
Rear View Camera	43
How To Use The Rear View Camera	45
Viewing Range On The Screen	45
Help Line	47

BASIC INFORMATION BEFORE OPERATION

INITIAL SCREEN

INITIAL SCREEN

! WARNING

- When the vehicle is stopped with the engine running, always apply the parking brake for safety.

1. When the ignition switch is in the “ACC” or “ON” position, the initial screen will be displayed and the system will begin operating.



- After a few seconds, the “Caution” screen will be displayed.

2. Select **I Agree** (I Agree).



LOADING AND UNLOADING A DISC

LOADING A DISC

CAUTION

- Never try to disassemble or oil any part of the CD player. Do not insert anything other than a disc into the slot.

1. Insert a disc into the disc slot.

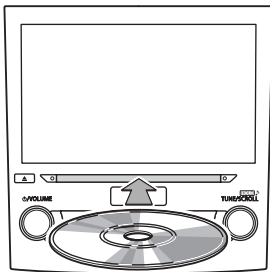

- After insertion, the disc is automatically loaded.

NOTE

- Compatible Disc: →P.165
- When inserting a disc, gently insert the disc with the label facing up.

UNLOADING A DISC

1. Press  and remove the disc.

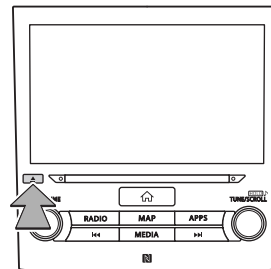

NOTE

- Discs can be unloaded even when the ignition switch is turned off.

CONNECTING AND DISCONNECTING A USB MEMORY DEVICE/PORTABLE DEVICE

CONNECTING A DEVICE

1. Connect a device.

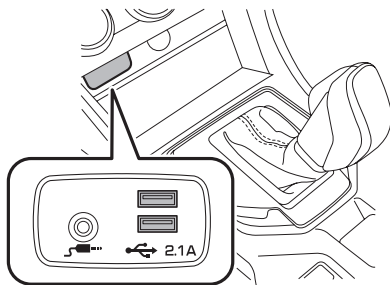



- Turn on the power of the device if it is not turned on.



NOTE

- Compatible USB memory device: →P.168
- Compatible iPhone/iPod: →P.168
- This unit does not support commercially available USB hubs.
- By connecting a device such as a cellular phone, charging starts depending on the device.

TOUCH SCREEN GESTURES

Operations are performed by touching the touch screen directly with your finger.

Operation method	Outline	Main use
	Touch Quickly touch and release once.	Changing and selecting various settings
	Double Touch with one finger*1 Quickly touch and release twice with one finger.	Enlarging the scale of the map screen
	Double Touch with two fingers*1 Quickly touch and release twice with two fingers.	Reducing the scale of the map screen

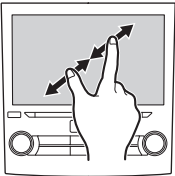
Operation method	Outline	Main use
	<p>Drag^{*2} Touch the screen with your finger, and move the screen to the desired position.</p>	<ul style="list-style-type: none"> • Scrolling the lists • Scrolling the map screen^{*1}
	<p>Swipe^{*2} Quickly move the screen by swiping with your finger.</p>	<ul style="list-style-type: none"> • Scrolling the lists • Scrolling the map screen^{*1}
	<p>Pinch^{*1} Move your two fingers further apart (pinch-out) to zoom in the map. Move your two fingers closer together (pinch-in) to zoom out the map.</p>	<p>Changing the scale of the map screen</p>

*1: 8-inch with Navi system only

*2: The above operations may not be performed on all screens.

NOTE

- Swipe operations may not be performed smoothly in high altitudes.

TOUCH SCREEN OPERATION

This system is operated mainly by the buttons on the screen. (Referred to as screen buttons in this manual.)

- When a screen button is touched, a beep sounds. The beep sound can be turned on/off. (→P.77)





CAUTION

- To prevent damaging the screen, lightly touch the screen buttons with your finger.
- Do not use objects other than your finger to touch the screen.
- Wipe off fingerprints using a glass cleaning cloth. Do not use chemical cleaners to clean the screen, as they may damage the touch screen.

NOTE

- If the system does not respond to touching a screen button, move your finger away from the screen and then touch it again.
- Dimmed screen buttons cannot be operated.
- The displayed image may become darker and moving images may be slightly distorted when the screen is cold.
- In extremely cold conditions, the map may not be displayed and the data input by a user may be deleted. Also, the screen buttons may be harder than usual to depress.

NOTE

- When  is displayed on the screen, select  to close a pop-up screen.

ENTERING LETTERS AND NUMBERS/LIST SCREEN OPERATION

ENTERING LETTERS AND NUMBERS

When searching by an address, name, etc., or entering data, letters and numbers can be entered via the screen.



No.	Information/Function
1	Input field <ul style="list-style-type: none"> The input field contains text to assist the user in completing tasks. The position of the cursor can be moved by selecting the desired location in the input field.
2	Select to clear the input field.
3	Displays candidate items based on the input letters. The desired item can be selected.
4	Select to erase one character.
5	Select to enter the item.
6	Select to change keyboard types.
7	Select to enter symbols.
8	Select to enter characters in lower case or in upper case.

NOTE

- The appearance of the keyboard may change or the input method may be limited depending on the circumstances where the software keyboard is displayed.

LIST SCREEN OPERATION

The list screen can be scrolled by a swipe gesture.

For details on the operation: →P. 34

The list screen can also be scrolled by the “TUNE/SCROLL” knob and pressing the knob will enter it.



No.	Information/Function
3	Some lists contain character screen buttons which allow users to jump directly to list entries that begin with the same letter as the character screen button. Every time the same character screen button is selected, the list starting with the subsequent character is displayed.

No.	Information/Function
1	Select to skip to the next or previous page.
2	This indicates the displayed screen's position. Faster scrolling is possible by dragging the position indicator.

SCREEN ADJUSTMENT

ADJUSTING BRIGHTNESS

The brightness of the screen can be adjusted. (→P.63)



CHANGING BETWEEN DAY AND NIGHT MODE (8-inch with Navi system only)



By setting “Map Display” to auto on the navigation settings screen, the map screen will change between day and night mode depending on the position of the headlight switch or illumination control dial and the surrounding brightness. (→P.197)

STATUS DISPLAY

The status of the Bluetooth connection, etc. is displayed on the screen.



No.	Name	Conditions
1	Screen name	Displays the screen name.
2	CD indicator	This icon is displayed when a disc has been inserted.
3	The level of Wi-Fi® reception	<div style="display: flex; align-items: center; justify-content: center;"> <div style="margin-right: 10px;">  <p>Poor</p> </div> <div style="margin: 0 20px;">  </div> <div style="margin-left: 10px;">  <p>Excellent</p> </div> </div> <p>When Wi-Fi® function is off, no item is displayed.</p>

No.	Name	Conditions
4	The Bluetooth connection indicator	This icon is displayed when the Bluetooth connection is established.
5	Remaining battery charge	 <p>The amount displayed does not always correspond with the amount displayed on the Bluetooth device.</p>
6	Reception level	 <p>The level of reception does not always correspond with the level displayed on the cellular phone. The level of reception may not be displayed depending on the phone you have.</p>
7	Active audio source	Select to display the active audio source information, radio frequency, and name of the artist and track currently playing, etc.

HOME SCREEN OPERATION

ADDING SHORTCUT ICONS TO THE HOME SCREEN

Shortcut icons for various functions can be added to the home screen when the home screen shortcut function is turned on. (→P.63)

1. Press .
2. Select **Add Shortcut** (Add Shortcut).

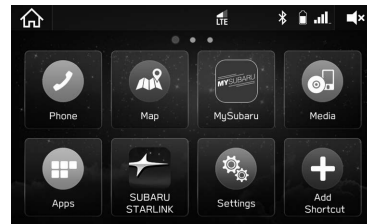

3. Select the desired function.

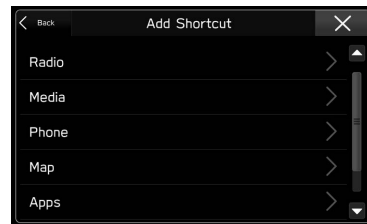

4. Select the desired shortcut function.

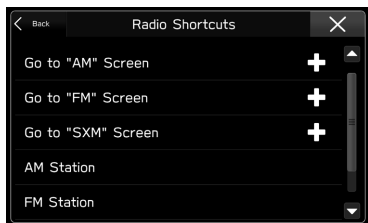

- Depending on the function, select other items and enter necessary information.
5. Check that the shortcut icon is displayed on the home screen.

NOTE

- The home screen has 3 pages, and shortcut icons can be added to each page. The page can be changed by swiping.

MOVING AND DELETING SHORTCUT ICONS

Users can rearrange the home screen buttons when the home screen shortcut function is turned on. (→P.63)

1. Select and hold the shortcut icon.

► When moving shortcut icons

2. Drag the button to the desired position.

- User can move buttons to another page by dragging them to the corresponding end of the screen if the number of buttons allows for multiple pages.

► When deleting shortcut icons

2. Drag the button to the bottom of the screen.

Sirius XM WEATHER ALERT (8-inch with Navi system only)

When a Sirius XM alert is received, a pop-up screen is displayed.



- **Settings** (Settings): Select to set the Sirius XM alert display conditions.
- To receive Sirius XM alerts, a subscription to the SiriusXM® Satellite Radio Service is necessary following a free trial. (→P.139)

REAR VIEW CAMERA

REAR VIEW CAMERA

A rear view camera is attached to the trunk lid or rear gate.

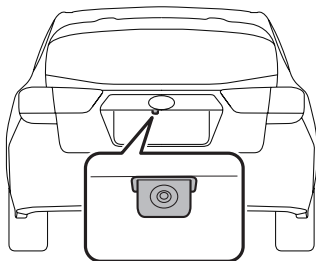

When the ignition switch is “ON” and the shift lever (Manual transmission models) or select lever (Continuously variable transmission models) is set to “R”, the rear view camera automatically displays the rear view image behind the vehicle. The rear view camera image is displayed on this system.

⚠ WARNING

- Since the rear view camera uses a wide-angle lens, the image on the monitor is different from the actual view in terms of distance.
- Since the range of the image on the monitor is limited, you should always check the rear view and the surrounding area with your eyes and mirrors, and move backward at a slow speed. Moving backward only by checking the rear view image from the camera could cause an accident.
- Do not disassemble or modify the camera, switch or wiring. If smoke comes out or you smell a strange odor, stop using the rear view camera immediately. Contact your SUBARU dealer for an inspection. Continued use may result in accident, fire or electric shock.
- Do not remove the SUBARU genuine navigation and/or audio system. If the SUBARU genuine navigation and/or audio system is removed, the rear view camera image and help lines (distance marker, dynamic guidelines and vehicle width lines) will no longer be displayed.

 **CAUTION**

- If your vehicle is washed with a high-pressure washer, do not allow water to contact the camera directly. Water entering the camera may cause condensation on the inside of the camera lens, damage and malfunction of the camera.
- Since the camera is a precision device, do not subject it to strong impacts. Otherwise, malfunction, fire or electric shock may occur.
- If mud or snow sticks to the camera, or it freezes up, you must be very careful when removing it. Pour water or lukewarm water over the camera to remove mud and ice, and wipe it with a soft, dry cloth.
- Do not try to melt snow or ice off of the camera using heat. Otherwise, damage to the camera may occur.
- When replacing the fuse, be sure to use a fuse with the specified rating. Using a fuse with a different rating may result in a malfunction.
- If the rear view camera is used for a long time while the engine is not operated, the battery may become completely discharged.

NOTE

- Do not wipe the camera with alcohol, benzine or paint thinner. Otherwise, discoloration may occur. To remove contamination, wipe the camera with a cloth moistened with a diluted neutral detergent and then wipe it with a soft, dry cloth.
- When waxing the vehicle, be careful not to apply the wax to the camera. If it comes in contact with the camera, moisten a clean cloth with a diluted neutral detergent to remove the wax.
- The camera lens has a hard coating to help prevent scratches. However, when washing the vehicle or cleaning the camera lens, be careful not to scratch the camera lens. Do not use a washing brush directly on the camera lens. The image quality of the rear view camera may deteriorate.
- Strong light shined on the camera lens may develop vertical lines around the light source. This is not a malfunction.
- Under fluorescent light, the display may flicker. However, this is not a malfunction.
- The image of the rear view camera may be slightly different from the actual color of the objects.

HOW TO USE THE REAR VIEW CAMERA

When the shift lever/select lever is set to “R”, the rear view camera automatically displays the rear view image from the vehicle. When the lever is set to other positions, the image before setting to “R” is displayed.

1. Set the ignition switch to “ON”.
2. Set the shift lever/select lever to “R”.

NOTE

- 8-inch with Navi system only: While the navigation system is activated, the image of the rear view camera will not be displayed. However, the image of the rear view camera has priority over other screen displays.
- The image of the rear view camera is horizontally reversed as is the case with the vehicle rearview mirror or the side view mirror.
- It may be difficult to see the image of the rear view camera in the following cases. This is not a malfunction of the camera.
 - The vehicle is in a dark place (at night, in a tunnel, etc.).
 - The vehicle is in an extremely hot or cold place.
 - An object (such as raindrops, snow, dirt, etc.) that disturbs the view of the rear view camera sticks to the lens of the camera.
 - Strong light shined directly on the camera lens (occasionally, there are vertical lines on the screen).
 - The vehicle is used for towing or a trailer hitch is installed.

SETTING THE CAMERA IMAGE DISPLAY TIME

The length of time that the camera image remains displayed when the shift lever/select lever is shifted from “R” to other position can be set. (→P.63)

VIEWING RANGE ON THE SCREEN

CAUTION

- The range that can be viewed with the rear view camera is limited. Always be sure to check with your eyes when moving backward and proceed slowly.

The area from the rear end of the bumper can be viewed. Areas at both ends of the bumper and areas just under the bumper cannot be viewed. Also, the image from the rear view camera looks shorter than the actual distance.

► Range of view

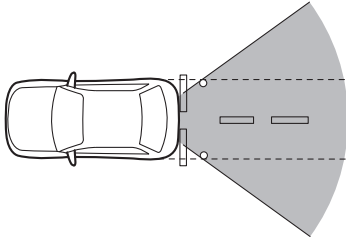
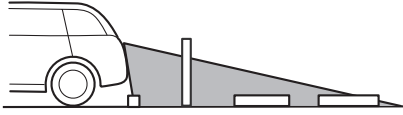

► Image from camera

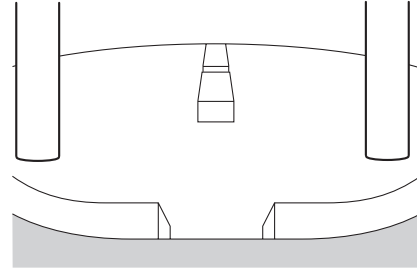

The area above the camera cannot be viewed. If there is an object that has a wide projection on its upper part such as a sign pole behind the vehicle, the projection cannot be seen on the screen.

► Range of view

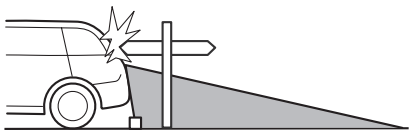

► Image from camera

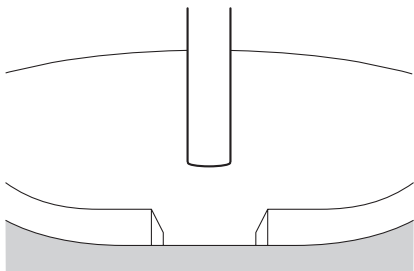

HELP LINE

The help line (distance marker, dynamic guidelines and vehicle width line) is a guide to help you realize the actual distance and course from the screen image.

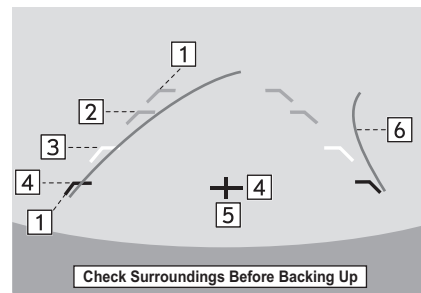

No.	Information
1	Vehicle width line (oblique vertical line)
2	Approx. 6 feet (2 m) from the bumper (green horizontal line)
3	Approx. 3 feet (1 m) from the bumper (yellow horizontal line)
4	Approx. 1.5 feet (0.5 m) or less from the bumper (red horizontal line)

No.	Information
5	Vehicle centerline
6	Dynamic guidelines

- When the shift lever/select lever is set to position “R”, the monitor screen displays the help lines together with the rear view image.

CAUTION

- When moving backward, always check the back with your eyes without relying on the help lines.
- The actual position and course may be different from the indication of the help lines.
- Differences may occur due to number of passengers or loaded cargo.
- When the vehicle is on a slope or when the vehicle is inclined against the road, the indication is different from the actual position.
- Be sure to observe the displayed warning message “Check Surroundings Before Backing Up”.

NOTE

- If you set the shift lever/select lever to “R” shortly after turning on the ignition switch, the warning message “Check Surroundings Before Backing Up” may not be displayed. Wait for several seconds or more after turning on the ignition switch before setting the shift lever/select lever to “R”. Then the warning message will be displayed.

DIFFERENCE BETWEEN SCREEN IMAGE AND ACTUAL ROAD

The distance markers show the distance for a level road when the vehicle is not loaded. It may be different from the actual distance depending on the loading conditions or road conditions.

► When there is an upward slope at the back

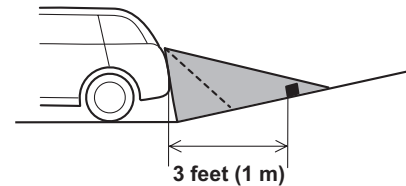

- The distance on the screen looks farther than the actual distance.

► When there is a downward slope at the back

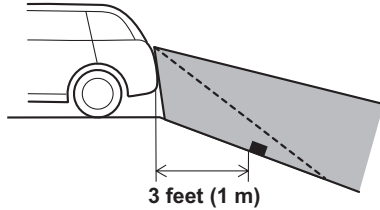

- The distance on the screen looks nearer than the actual distance.

NOTE

- When cargo is loaded, the rear view distance on the screen looks farther than the actual distance as in an upward slope.

FEATURE OF DISTANCE MARKER

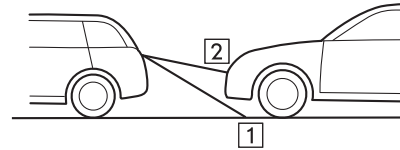

No.	Information
1	3 feet (1 m) line
2	6 feet (2 m) line

- The distance marker shows the distance on the road. If there is a vehicle or other object close behind, distance cannot be correctly displayed.

3 Settings

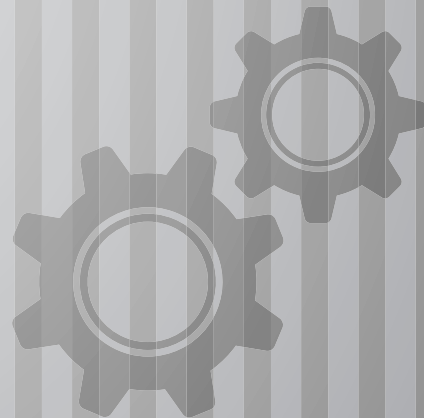

Bluetooth® Settings 52

Registering A Bluetooth Phone/ Device For The First Time	52
Profiles	53
Bluetooth Settings	55
Registering A Bluetooth Phone/Device	56
Connecting Or Disconnecting Bluetooth Phone/Device	58
Deleting Bluetooth Phones/Devices	60
Setting Phonebook Download	61
Setting The Automatic Connection Priority ..	62

Other Settings 63

General Settings	63
General Settings Screen	63
Setting The Driver Profile	66
Setting Wi-Fi® Connection	69
Updating The System	72
Sound Settings	77
Changing Volume Settings For Each Function	77
Sound Settings Screen	78
Vehicle Customization	80
Vehicle Settings Screen	80

Clock Settings 82

Clock Settings	82
Preparation For Clock Adjustment Setting ..	82
Setting The Clock Automatically	82
Setting The Clock Manually	83

Bluetooth® SETTINGS

REGISTERING A Bluetooth PHONE/ DEVICE FOR THE FIRST TIME



The Bluetooth® word mark and logos are registered trademarks owned by Bluetooth SIG, Inc.

To use the hands-free system or the Bluetooth audio system, it is necessary to register a Bluetooth phone/device with the system.

Once the Bluetooth phone/device has been registered, it is possible to use the hands-free system and the Bluetooth audio system.

This operation cannot be performed while driving.

For details on registering a Bluetooth phone/device:
→P.56

1. Turn the Bluetooth connection setting of your Bluetooth phone/device on.
 - This function is not available when the Bluetooth connection setting of your Bluetooth phone/device is set to off.
2. Display the phone screen. (→P.86)
3. Select **Yes** (Yes) to register a Bluetooth phone/device.



4. Follow the steps in “REGISTERING A Bluetooth PHONE/DEVICE” from “STEP 3” to “STEP 7”. (→P.56)

PROFILES

This system supports the following services.

Bluetooth Device	Spec.	Function	Requirements	Recommendations
Bluetooth Phone/Device	Bluetooth Specification	Registering a Bluetooth phone/device	Ver. 1.1	Ver. 3.0+EDR

Bluetooth Device	Profile	Function	Requirements	Recommendations
Bluetooth Phone	HFP (Hands-Free Profile)	Hands-free system	Ver. 1.0	Ver. 1.6
	PBAP (Phone Book Access Profile)	Transferring the contacts	Ver. 1.0	Ver. 1.1.1
	MAP (Message Access Profile)	Bluetooth phone message	-	Ver. 1.0
	PAN (Personal Area Networking Profile)	APPS function	-	PAN 1.0
	SPP (Serial Port Profile)	APPS function	-	Ver. 1.1

Bluetooth Device	Profile	Function	Requirements	Recommendations
Bluetooth Device	A2DP (Advanced Audio Distribution Profile)	Bluetooth audio system	Ver. 1.0	Ver. 1.2
	AVRCP (Audio/Video Remote Control Profile)		Ver. 1.0	Ver. 1.4

NOTE

- If your cellular phone does not support HFP, registering the Bluetooth phone or using PBAP, MAP or SPP profiles individually will not be possible.
- If the connected Bluetooth phone/device version is older than recommended or incompatible, the Bluetooth phone/device function may not work properly.
- If the application is not running smoothly or is unstable, disconnect and reconnect the Bluetooth phone/device via Bluetooth (→P.58) and/or USB cable (→P.34). If the problem continues, reboot the Bluetooth phone/device.

Bluetooth SETTINGS

1. Press .

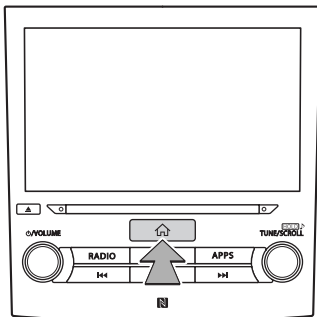

2. Select **Settings** (Settings).
 3. Select **Phone** (Phone).

► When registering a Bluetooth phone/device

4. Select **Add Device** (Add Device).

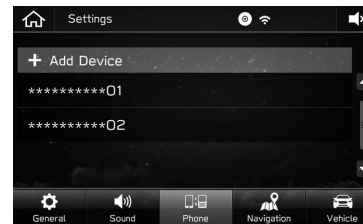

- For details on registering a Bluetooth phone/device:
→P.56

► When setting the Bluetooth phone/device

4. Select the desired Bluetooth phone/device.
5. Select the item to be set.

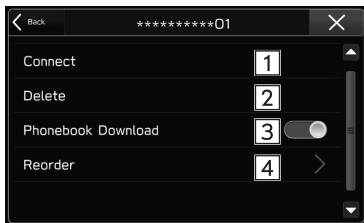

No.	Function	Page
1	Connecting or disconnecting Bluetooth phones/devices	58
2	Deleting Bluetooth phones/devices	60
3	Setting phonebook download	61
4	Setting the automatic connection priority	62

NOTE

- The phone settings screen can also be displayed by selecting **Change Device** (Change Device) on the phone overview screen (→P.86) or Bluetooth audio operation screen (→P.156).

REGISTERING A Bluetooth PHONE/DEVICE

Up to 5 Bluetooth phones/devices can be registered.

Bluetooth compatible phones (HFP) and devices (AVP) can be registered simultaneously.

This operation cannot be performed while driving.

1. Display the phone settings screen. (→P.55)
2. Select **Add Device** (Add Device).

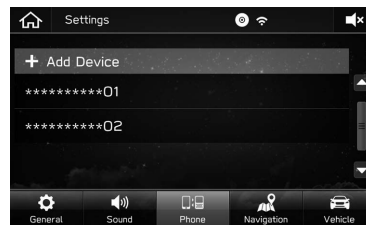

- If a message appears, follow the guidance on the screen.

- When this screen is displayed, search for the device name displayed on this screen on the screen of your Bluetooth phone/device.



- **Cancel** (Cancel): Select to cancel the registration.
 - For details on operating the Bluetooth phone/device, see the manual that comes with it.
- Register using your Bluetooth phone/device.
 - A PIN-code is not required for SSP (Secure Simple Pairing) compatible Bluetooth phones/devices. Depending on the type of Bluetooth phone/device being connected, a message confirming registration may be displayed on the Bluetooth phone's/device's screen. Respond and operate the Bluetooth phone/device according to the confirmation message.
 - When registering an NFC compatible device, registration is performed when the Bluetooth phone/device is held against the NFC logo of the audio system until a connection is established.

NOTE

- To re-register your Bluetooth phone/device after having deleted it from the system, operate the Bluetooth phone/device and register it after deleting the previously registered system information from the Bluetooth phone/device.

- Select **Confirm** (Confirm).

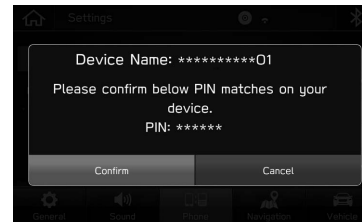

- **Cancel** (Cancel): Select to cancel the registration.
- Check that the following pop-up screen may be displayed.

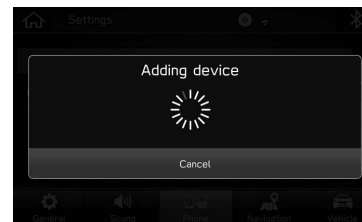

- **Cancel** (Cancel): Select to cancel the registration.

7. Check that the following pop-up screen is displayed when the connection is complete.

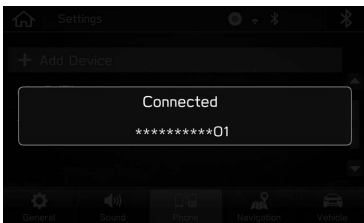

- If a confirmation message appears asking whether to transfer the phone's contact data to the system, select the appropriate button.
- If an error message appears, follow the guidance on the screen to try again.

CONNECTING OR DISCONNECTING Bluetooth PHONE/DEVICE

Up to 5 Bluetooth phones/devices (Phones (HFP) and devices (AVP)) can be registered.

If more than 1 Bluetooth phone/device has been registered, select which Bluetooth phone/device to connect to.

1. Display the phone settings screen. (→P.55)
2. Select the Bluetooth phone/device to be connected or disconnected.

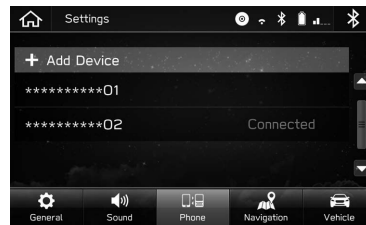

- “Connected” is displayed next to the currently connected Bluetooth phone/device.
- If the desired Bluetooth phone/device is not on the list, select **Add Device** (Add Device) to register the Bluetooth phone/device. (→P.56)

3. Select **Connect** (Connect) or **Disconnect** (Disconnect).

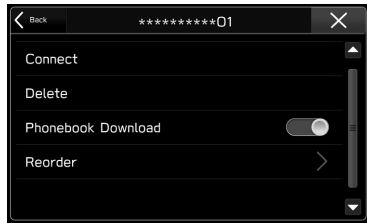

4. Check that “Connected” is displayed next to the Bluetooth phone/device when the connection is complete.
- If an error message appears, follow the guidance on the screen to try again.

NOTE

- It may take time if the Bluetooth phone/device connection is carried out during Bluetooth audio playback.
- Depending on the type of Bluetooth phone/device being connected, it may be necessary to perform additional steps on the Bluetooth phone/device.

AUTO CONNECTION MODE

Leave the Bluetooth phone/device in a location where the connection can be established.

- When the ignition switch is in the “ACC” or “ON” position, the system searches for a nearby registered Bluetooth phone/device.
- The system will connect with the registered Bluetooth phone/device that was last connected, if it is nearby.

CONNECTING MANUALLY

When the auto connection has failed, it is necessary to connect Bluetooth phones/devices manually.

1. Press , and then select **Settings** (Settings).
2. Select **Phone** (Phone).
3. Follow the steps in “CONNECTING OR DISCONNECTING Bluetooth PHONE/DEVICE” from “STEP 2”. (→P.58)

RECONNECTING THE Bluetooth PHONE/DEVICE

If a Bluetooth phone/device is disconnected due to poor reception from the Bluetooth network when the ignition switch is turned to the “ACC” or “ON” position, the system automatically reconnects the Bluetooth phone/device.

- If a Bluetooth phone/device is disconnected on purpose, such as turning it off, this does not happen. Reconnect the Bluetooth phone/device manually.

DELETING Bluetooth PHONES/DEVICES

1. Display the phone settings screen. (→P.55)
2. Select the desired Bluetooth phone/device.

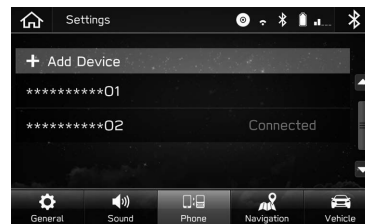

3. Select **Delete** (Delete).

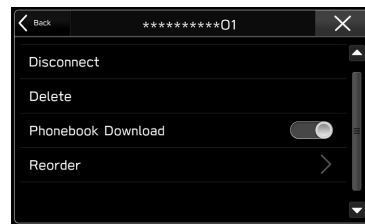

4. Select **Delete** (Delete) when the confirmation message appears.

NOTE

- The Bluetooth phone/device will still contain information from this system even after the Bluetooth phone/device has been deleted. Operate the Bluetooth phone/device to delete the system information saved inside the Bluetooth phone/device.

SETTING PHONEBOOK DOWNLOAD

When this function is activated, the phonebook data of the connected phone will be downloaded automatically.

1. Display the phone settings screen. (→P.55)
2. Select the Bluetooth phone to be set.

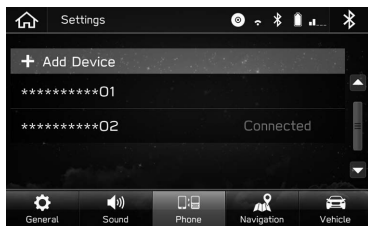

3. Select to turn “Phonebook Download” on/off.

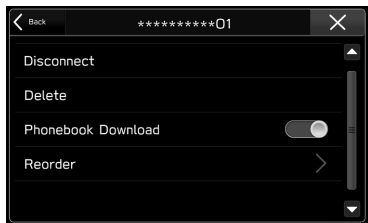

NOTE

- The profile version of the connected Bluetooth phone may not be compatible with transferring phonebook data. For details, contact your SUBARU dealer.
- Up to 2000 contacts in the phonebook of a registered Bluetooth phone can be downloaded. If the phonebook of the Bluetooth phone has over 2000 contacts, part of the phonebook will not be downloaded.
- The notification setting on the Bluetooth phone may need to be activated in order to download the phonebook. For details, check the instructions for the connected Bluetooth phone. When the system's clock settings are set to auto, the auto-adjustment function (→P.82) and message function (→P.97) will not function properly if the phonebook is not downloaded.
- The Bluetooth phone's favorite list will not be downloaded automatically even after the phonebook data has been downloaded from the Bluetooth phone. This system does not currently support transfer of data from the Bluetooth phone favorites list. To add the Bluetooth phone's favorites list to the system's favorites list, you need to register it through the system phonebook contacts list. (→P.93)

SETTING THE AUTOMATIC CONNECTION PRIORITY

The automatic connection priority of the registered Bluetooth phones/devices can be changed.

1. Display the phone settings screen. (→P.55)
2. Select the Bluetooth phone/device to be set.

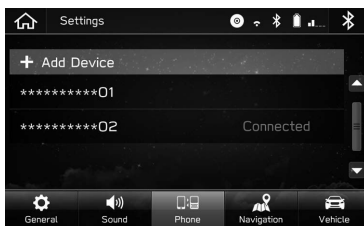

3. Select **Reorder** (Reorder).

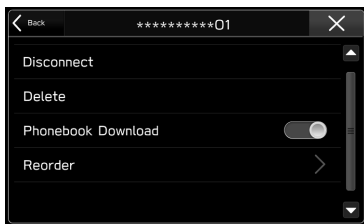

4. Select **☰** next to the desired Bluetooth phone/device, and then drag it to the desired position.

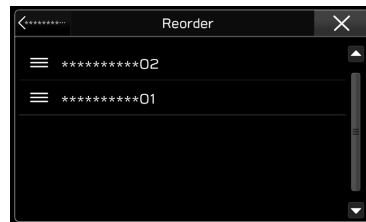

OTHER SETTINGS

GENERAL SETTINGS

1. Press .

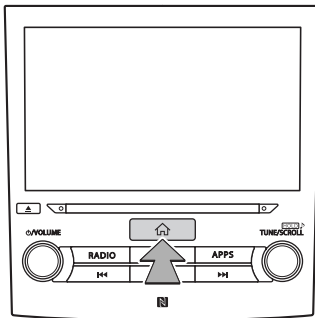

2. Select **Settings** (Settings).
 3. Select **General** (General).
 4. Select the items to be set.

GENERAL SETTINGS SCREEN

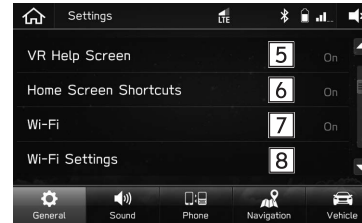
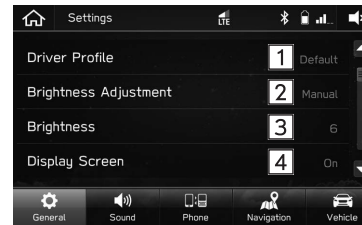

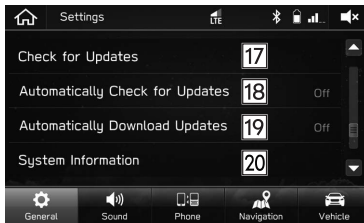
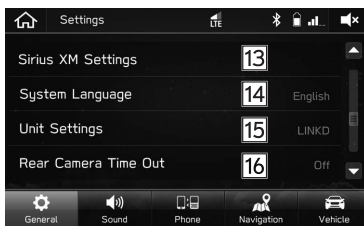

No.	Function	Page
1	Select to set the driver profile.	66
2	Select to switch screen brightness adjustment between Auto/Manual.	-

No.	Function	Page
3	Select to adjust the screen brightness manually. This function is available when "Brightness Adjustment" is set to "Manual".	-
4	Select to turn the screen on/off.	-
5	Select to turn the voice recognition prompts on/off.	-
6	Select to turn the home screen shortcuts function on/off.	40
7	Select to turn the Wi-Fi® function on/off.	-
8	Select to set Wi-Fi® connection settings.	69
9 *1	Select to turn the Wi-Fi Hotspot connection on/off.	-
10 *1	Select to set the Wi-Fi Hotspot settings.	-
11	Select to set whether to automatically change to the Android Auto screen when an Android device is connected.	-
12	Select to set whether to automatically start playing when an iPhone/iPod or a USB memory device containing audio files is connected.	-

No.	Function	Page
13	Select to display Sirius XM subscription. Select to turn the Tune Start function on/off. Select to turn the Sports Flash function on/off.	-
	Select to set the Sirius XM alert display conditions.*2	42
14	Select to change the language. When Synchronized Language Settings (Synchronized Language Settings) is selected, the language setting in the system is synced to the language setting in the meter cluster.	-
15 *2	Select to change the unit of measure for distance. When Units Synchronized (Units Synchronized) is selected, the unit of measure setting in the system is synced to the unit of measure setting in the meter cluster.	-
16	Select to set the length of time that the camera image remains displayed when the shift lever/select lever is shifted from "R" to other position.	-
17	Select to update system software versions.	72
18	Select to turn the available new system software version check on/off.	72
19	Select to turn the automatic downloading of updates on/off.	72

No.	Function	Page
20	Select to display the system information.	-
21	Select to change the Bluetooth system name.	-
22	Select to reset all setup items. The audio system restarts automatically after resetting factory data. To complete the reset process, turn the ignition switch to the "LOCK"/"OFF" position after the audio system has restarted, and then turn to the "ACC" or "ON" position after approximately 3 minutes. • Vehicles equipped with "SUBARU STARLINK Safety and Security" and an 8-inch system only: When resetting the system, it is necessary to pair your smartphone via Bluetooth. Please contact your SUBARU dealer for details.	-
23	Select to display the software license.	-

*1: Only in vehicles with "SUBARU STARLINK Safety and Security"
Refer to the "SUBARU STARLINK Safety and Security" Owner's Manual for details.

*2: 8-inch with Navi system only

SETTING THE DRIVER PROFILE

ADDING A NEW PROFILE

1. Display the general settings screen. (→P.63)
2. Select **Driver Profile** (Driver Profile).
3. Select **Add New Profile** (Add New Profile).

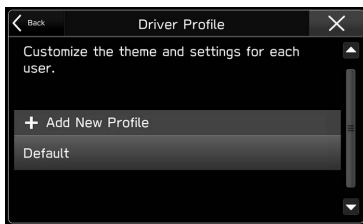

4. Select **Enter Name** (Enter Name).

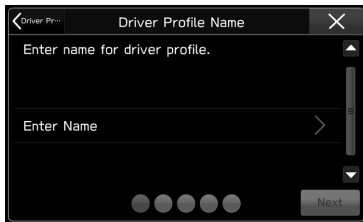

5. Enter a name, and then select **Next** (Next).

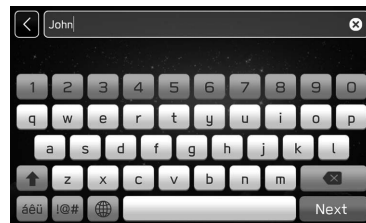

6. Select **Next** (Next).

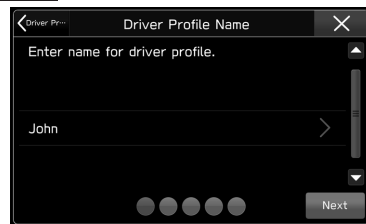

7. Select **Add Phone** (Add Phone) to register a Bluetooth phone/device.

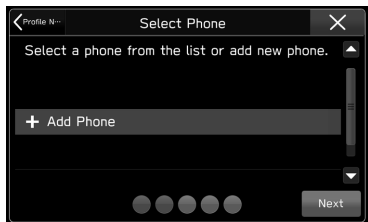

- To skip registration, select **Next** (Next) before registration, and then select **Skip** (Skip).
8. Follow the steps in “REGISTERING A Bluetooth PHONE/DEVICE” from “STEP 3” to “STEP 7”. (→P.56)
9. Select **Next** (Next).

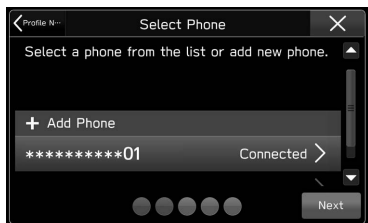

▶ **8-inch system**

10. Proceed to “STEP 15”.

▶ **8-inch with Navi system**

10. Select **Home Address** (Home Address).

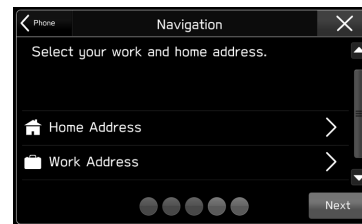

- To skip registration, select **Next** (Next) before registration.

11. Enter an address, and then select **Search** (Search).



12. Select the desired item from the list, and then select **Save** (Save).

13. Select **Work Address** (Work Address) and register in the same way as a home address.

14. Select **Next** (Next).

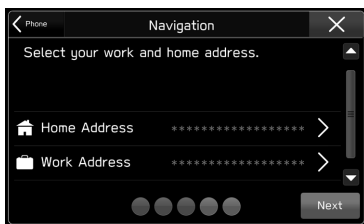

15. Select the desired wallpaper, and then select **Next** (Next).

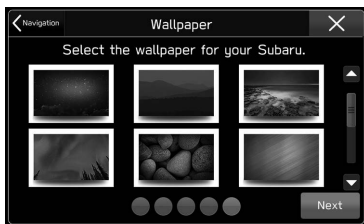

- To skip registration, select **Next** (Next) before registration.

16. Select **Finish** (Finish).

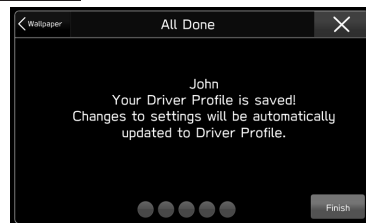

After setting up, you can change home or work address and phone settings, etc.

- Changing the home/work address: →P.180
- Changing the Bluetooth phone/device: →P.55
- Editing the driver profile: →P.69

NOTE

- Up to 4 driver profiles can be registered.

EDITING THE DRIVER PROFILE

1. Display the general settings screen. (→P.63)
2. Select **Driver Profile** (Driver Profile).
3. Select the desired profile.
4. Select the desired item to be set.

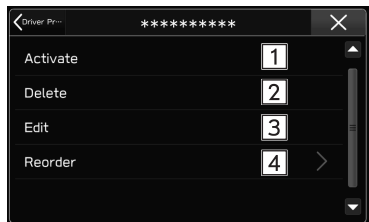

No.	Function
1	Select to change the driver profile.
2	Select to delete the driver profile.
3	Select to edit the driver profile. Follow the steps in “ADDING A NEW PROFILE” from “STEP 4”. (→P.66)
4	Select to reorder the driver profile.

SETTING Wi-Fi® CONNECTION

CONNECTING OR DISCONNECTING A Wi-Fi® NETWORK

1. Display the general settings screen. (→P.63)
2. Select **Wi-Fi Settings** (Wi-Fi Settings).
3. Select the desired network.



- **Add New Network** (Add New Network): Select to add a Wi-Fi® network. (→P.70)

4. Select **Connect** (Connect) or **Disconnect** (Disconnect).



- When a network with **🔒** is selected and the password entry screen is displayed, enter the password, and then select **Join** (Join).
 - **Forget This Network** (Forget This Network): Select to delete the item.
5. Check that a confirmation message appears when the connection is complete.
- If an error message appears, follow the guidance on the screen to try again.

ADDING A WI-FI® NETWORK

Available networks which are not displayed by searching can be added.

1. Display the general settings screen. (→P.63)
2. Select **Wi-Fi Settings** (Wi-Fi Settings).
3. Select **Add New Network** (Add New Network).
4. Enter the network name, and then select **Join** (Join).
5. Select the security type.

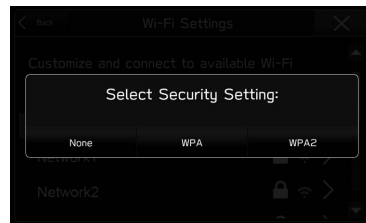

6. Enter the password, and then select **Join** (Join).
7. Check that a confirmation message appears when the connection is complete.

⚠ WARNING

- Use Wi-Fi® devices only when safe and legal to do so.
- This system is fitted with Wi-Fi® antennas. People with implantable cardiac pacemakers, cardiac resynchronization therapy-pacemakers or implantable cardioverter defibrillators should maintain a reasonable distance between themselves and the Wi-Fi® antennas. The radio waves may affect the operation of such devices.
- Before using Wi-Fi® devices, users of any electrical medical device other than implantable cardiac pacemakers, cardiac resynchronization therapy-pacemakers or implantable cardioverter defibrillators should consult the manufacturer of the device for information about its operation under the influence of radio waves.

Radio waves could have unexpected effects on the operation of such medical devices.

SUPPORTED Wi-Fi NETWORK SPECIFICATIONS

The system can connect to a Wi-Fi network that supports the following standards.

- Communication standards:
 - 802.11b
 - 802.11g
 - 802.11n (2.4GHz/5GHz)
 - 802.11a
- Security:
 - WPA™
 - WPA2™

NOTE

- WPA and WPA2 are registered mark of the Wi-Fi Alliance®.

UPDATING THE SYSTEM

BEFORE UPDATE

WARNING

- The engine does not need to be running to update the system. If you leave the engine running while downloading or installing an update, do not park the vehicle in a confined space, such as a garage. Doing so could cause serious injury or death.

CAUTION

- **When performing an update using Wi-Fi or a smartphone, make sure to park the vehicle in an area with low electrical noise and network signal is strong enough.**
- **8-inch with Navi system: Park the vehicle in an area where GPS signals can be received normally.**
- **If an update is performed in an area with electrical noise and/or weak network signal, it may take a long time to complete or an error may occur.**

NOTE

- Update using Wi-Fi or a smartphone may not be available in some countries.
- After performing an update, various settings may be reset to their default setting. In this case, it will be necessary to set them to your desired setting again.

UPDATE THE CLOCK

In order to accurately check for software updates, the clock of the system needs to be set to the correct time.

Perform either of the following procedures to set the clock using GPS signals or a smartphone.

Once the clock is set, it will not need to be adjusted unless the power supply is cut due to the battery being depleted or replaced.

► 8-inch with Navi system

1. Check that the current vehicle position is correctly displayed on the navigation system screen.
 - If the position is correct, proceed to “CONNECTING TO THE NETWORK”. (→P.73)
2. If the position is not correct, move the vehicle to an area where GPS signals can be received normally (outside, etc.).
 - Once the vehicle is correctly positioned, proceed to “CONNECTING TO THE NETWORK”. (→P.73)

► 8-inch system

1. Pair the smartphone with the system using Bluetooth. (→P.56) Transfer the phonebook data at this time. (→P.61)
2. On the Bluetooth settings screen of the smartphone, check that the phonebook transfer and notification permission settings are both set to on for the “SUBARU BT” paired device.

NOTE

- It may take some time before the correct time is displayed.

CONNECTING TO THE NETWORK

► When updating via a Wi-Fi connection

1. Connect to a Wi-Fi network device (router, access point, etc.) (→P.69)
 - When a connection is established, the Wi-Fi connection status icon will be displayed. Check that the connection is sufficiently strong and stable. (→P.39)

► When updating via the Aha application on a smartphone

1. Download the Aha application to the smartphone to be connected, or update the app if already installed.
2. Start the Aha application on the smartphone.
3. If updates are to be downloaded using mobile data, turn the “Download on WiFi Only” setting of the Aha application off.
 - If the smartphone is to be connected to a Wi-Fi network device, it is not necessary to turn this setting off.
4. Connect the smartphone to the system.
 - When using an Android OS smartphone, connect it via Bluetooth. (→P.58)
 - When using an iOS device, connect it via Bluetooth or undamaged genuine USB cable. (→P.34, 58)

DOWNLOAD UPDATE

1. Display the general settings screen. (→P.63)
2. Select **Check for Updates** (Check for Updates).
 - When the system is started, **Check for Updates** (Check for Updates) will be greyed out and cannot be selected for approximately 1 minute.
 - If the “Software Update Ready To Download” pop-up is displayed:
Select **Download Now** (Download Now) to download the latest software update.

3. Wait for the download progress to reach 100%.



- When downloading updates using the Aha application on a smartphone, the download progress will be displayed on the system screen after the update has been downloaded to the smartphone and the smartphone begins transferring it to the system. Therefore, it may take some time before the download progress is displayed.
- Approximate time to complete download to the system
 - Wi-Fi: 5-20 minutes (Depending on connection speed and signal strength.)
 - Aha application via Bluetooth: 10-50 minutes (Depending on smartphone OS (Android or iOS).)
 - Aha application via USB (iOS only): 5-10 minutes

4. After downloading has completed, check that “Software Update Ready To Install” is displayed.
- If you are ready to install the update, proceed to “INSTALL UPDATE”. (→P.75)
 - If you wish to install the update later, select **Cancel** (Cancel).
 - If **Cancel** (Cancel) is selected, it will be necessary to perform the “DOWNLOAD UPDATE” procedure again from “STEP 1”. (→P.74)
 - If the “Connect To Wi-Fi” pop-up is displayed:
Perform the “CONNECTING TO THE NETWORK” procedure again. (→P.73)
 - If the “Your device’s software is up to date.” pop-up is displayed:
The system software is already the latest version and update is not necessary.
 - If the “Software download failed. Do you want to retry?” pop-up is displayed:
The system clock may not be set correctly.
Move the vehicle to where GPS signals can be received normally or connect a smartphone via Bluetooth to adjust the clock.
Perform the “UPDATE THE CLOCK” procedure again. (→P.72)
 - If the update procedure fails, refer to the “WHAT TO DO IF” section. (→P.237)

INSTALL UPDATE

WARNING

- The engine does not need to be running to update the system. If you leave the engine running while downloading or installing an update, do not park the vehicle in a confined space, such as a garage. Doing so could cause serious injury or death.

CAUTION

- Park your vehicle in a safe place and do not operate it while the update is installing.
- The following system functions are restricted during the update installation.
 - It will not be possible to use general system functions.
 - The rear view camera may be fully or partially disabled during the update. The help line (distance marker, dynamic guidelines and vehicle width line) will not be displayed.

1. Select **Install Now** (Install Now).
 - The update will begin installing.
2. Wait until the update installation has completed.
 - Approximate time to complete installation: 10 minutes
3. After installation has completed, check that the system restarts automatically.
 - The update may be performed in 2 steps. In this case, the system will restart 2 times. Wait for the home screen to be displayed.
 - Depending on the system, an update may be performed in 3 steps. In this case, the system will restart 3 times. This does not indicate a malfunction.
4. Press 
 - If the home screen is displayed, the update has completed normally.
 - To check the software version, select **System Information** (System Information) on the general settings screen. (→P.63)
5. Operation is complete.

CAUTION

- If the “Software update install failed” screen is displayed, contact your SUBARU dealer immediately. If this screen is displayed, none of the system functions, other than the rear camera, will operate. When using the rear camera, only the camera image will be displayed. The help line (distance marker, dynamic guidelines and vehicle width line) will not be displayed.

NOTE

- Vehicles with an active SUBARU STARLINK Safety and Security contract:
The functions of this service which are operable using the system screen will not be able to be used. However all other functions of the service can still be used by operating the “SOS” button or “i” button on the overhead console.

SOUND SETTINGS





CHANGING VOLUME SETTINGS FOR EACH FUNCTION

The volume can be adjusted by turning the “**VOLUME**” knob or operating the volume control switch of the steering switches.

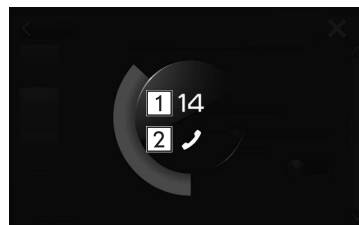
The adjusted volume will change depending on the screen displayed and system status.

When adjusting the volume, a volume display will temporarily be displayed and the volume of which function is being adjusted and the current volume can be checked.



No.	Icon	Function
1	-	Current volume
2		Hands-free system volume setting (→P.94)
		Audio volume setting (→P.128)
	 *	Navigation voice guidance volume setting (→P.193)
		Voice recognition system volume setting (→P.214)

*: 8-inch with Navi system only

SOUND SETTINGS SCREEN

1. Press .

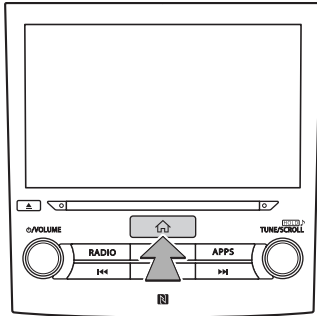

2. Select **Settings** (Settings).
3. Select **Sound** (Sound).
4. Select the items to be set.

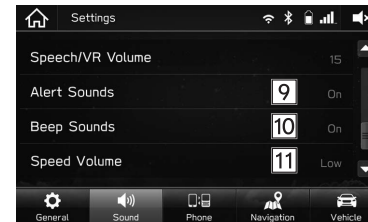
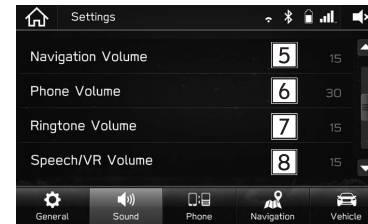
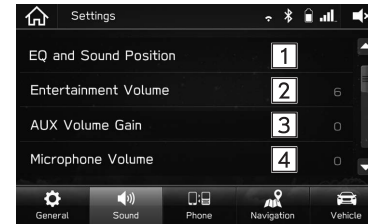

No.	Function
1	Select to set sound settings. (→P.130)
2	Select to set audio volume.
3	Select to set AUX volume gain.
4	Select to adjust the mic sensitivity. This adjusts the speaker's voice during hands-free communication.
5 *1	Select to set the navigation prompt volume.
6	Select to set to adjust the default volume of the other party's voice.
7	Select to adjust the ringtone volume.
8	Select to set the voice recognition prompts volume.
9	Select to turn the alert sound when traffic, weather, or SXM game information is updated on/off.
10	Select to turn the sound beeps on/off.

No.	Function
11 *2	Select to set the speed volume. The system adjusts to the optimum volume and tone quality according to vehicle speed to compensate for increased vehicle noise.

*1: 8-inch with Navi system only

*2: This setting can be made depending on the connected amplifier type.

VEHICLE CUSTOMIZATION

1. Press .

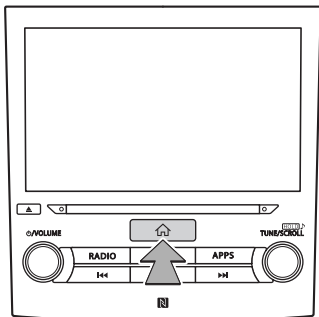

2. Select **Settings** (Settings).
 3. Select **Vehicle** (Vehicle).
 4. Select the desired item to be set.

NOTE

- When the settings screen is displayed on the combination meter display or multi function display, vehicle customization cannot be performed at the vehicle settings screen.

VEHICLE SETTINGS SCREEN

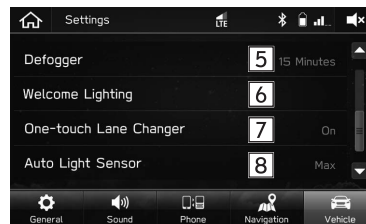

No.	Function
1	Select to change the displayed time and format (12/24 hour display) settings of the clock displayed on the multi function display. The set display format will also be used for all time displays on the system screen. For details, refer to "CLOCK SETTINGS". (→ P.82)
2	Select to set and customize the interior light off delay timer.
3	Select to set the settings used when the keyless access function was operated.

No.	Function
4	Select to set the lock/unlock conditions.
5	Select to set and customize the operation of the defogger.
6	Select to set the leaving time and approaching time.
7	Select to turn the one-touch lane changer on/off.
8	Select to set and customize the sensitivity of the auto light sensor.

CLOCK SETTINGS

CLOCK SETTINGS

The clock can be adjusted using either “Auto” mode or “Manual” mode.

- “Auto” mode: automatic clock adjustment
- “Manual” mode: manual clock adjustment

PREPARATION FOR CLOCK ADJUSTMENT SETTING

Before setting the clock, the setting mode (“Auto” or “Manual”) will need to be selected.

To select the mode, perform the following procedure.

1. Press .

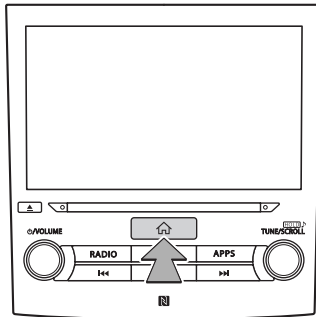

2. Select **Settings** (Settings).
3. Select **Vehicle** (Vehicle).
4. Select **Time/Date** (Time/Date), and then select either “Manual” or “Auto”.

NOTE

- **Time/Date** (Time/Date) cannot be set when the charging connector is inserted to the charge port.
- Select the clock format between “12 Hour” mode or “24 Hour” mode.

SETTING THE CLOCK AUTOMATICALLY

To set the clock automatically, the “Auto” mode must be selected in the clock adjustment setting preparation procedure.

► 8-inch with Navi system

The clock will be set automatically where a GPS signal is available.

► 8-inch system

The clock will be set and adjusted automatically when a smartphone is connected via Bluetooth for transferring phonebook data.

1. Register the smartphone to the audio system.
 - For details, refer to “Bluetooth® SETTINGS”. (→P.52)
2. Transfer phonebook data to the system.
 - For details, refer to “SETTING PHONEBOOK DOWNLOAD”. (→P.61)
 - The clock will be adjusted automatically.

NOTE

- Depending on the model of smartphone, setting of connected smartphone may need to be changed. (ex: For iOS or other models, notification setting may need to be activated.) For details, check the instruction of connected smartphone.

SETTING THE CLOCK MANUALLY

To set the clock in manual mode, “Manual” must be selected in the clock adjustment setting preparation procedure.

1. Select “Manual” mode.
2. Adjust “Hour”.
3. Adjust “Minute”.
4. Adjust “Month”.
5. Adjust “Day”.
6. Adjust “Year”.

4 Phone





Phone Operation	86
Phone Screen	86
Some Basics	87
Registering/Connecting A Bluetooth Phone	88
Using The Phone Switch/Microphone	88
Voice Recognition System	89
About The Contacts In The Contact List	89
When Selling Or Disposing Of The Vehicle	90
Calling On The Bluetooth Phone	90
By The Last Number	91
By Favorites List	92
By Recent Calls List	92
By Keypad	93
By Contacts List	93

Receiving On The Bluetooth Phone	94
Incoming Calls	94
Talking On The Bluetooth Phone	95
Sending Tones	95
Call Waiting	96
Bluetooth Phone Message Function	97
Receiving A Message	98
Checking Messages	99
Replying To A Message (Quick Reply)	100
Sending A New Short Message	101
Calling The Message Sender	102

PHONE OPERATION (HANDS-FREE SYSTEM FOR CELLULAR PHONES)

PHONE SCREEN

The phone screen can be accessed with the following methods:

- Press , and then select **Phone** (Phone).
- 8-inch system only: Press .



	Function	Page
Phone operation	Registering a Bluetooth phone/device	52
	Calling on the Bluetooth phone	90
	Receiving on the Bluetooth phone	94
	Talking on the Bluetooth phone	95
Message function	Using the Bluetooth phone message function	97
Setting up a phone	Setting the Bluetooth phone/device	55

SOME BASICS

The hands-free system enables calls to be made and received without having to take your hands off the steering wheel.

This system supports Bluetooth. Bluetooth is a wireless data system that enables cellular phones to be used without being connected by a cable or placed in a cradle.

The operating procedure of the phone is explained here.

WARNING

- While driving, do not use a cellular phone or connect the Bluetooth phone.
- This system is fitted with Bluetooth antennas. People with implantable cardiac pacemakers, cardiac resynchronization therapy-pacemakers or implantable cardioverter defibrillators should maintain a reasonable distance between themselves and the Bluetooth antennas. The radio waves may affect the operation of such devices.
- Before using Bluetooth phones, users of any electrical medical device other than implantable cardiac pacemakers, cardiac resynchronization therapy-pacemakers or implantable cardioverter defibrillators should consult the manufacturer of the device for information about its operation under the influence of radio waves. Radio waves could have unexpected effects on the operation of such medical devices.

CAUTION

- Do not leave your cellular phone in the vehicle. The temperature inside may rise to a level that could damage the phone.

NOTE

- If your cellular phone does not support Bluetooth, this system cannot function. Certain functions may not be available depending on the type of cellular phone.
- In the following conditions, the system may not function:
 - The cellular phone is turned off.
 - The current position is outside the communication area.
 - The cellular phone is not connected.
 - The cellular phone has a low battery.
- When using the hands-free function and other Bluetooth functions at the same time, the following problems may occur:
 - The Bluetooth connection may be cut.
 - Noise may be heard when playing back voice with the Bluetooth function.
- The other party's voice will be heard from the front speakers. The audio system will be muted during phone calls or when hands-free voice commands are used.
- Talk alternately with the other party on the phone. If both parties speak at the same time, the other party may not hear what has been said. (This is not a malfunction.)
- Keep call volume down. Otherwise, the other party's voice may be audible outside the vehicle and voice echo may increase. When talking on the phone, speak clearly towards the microphone.

NOTE

- The other party may not hear you clearly when:
 - Driving on an unpaved road. (Making excessive traffic noise.)
 - Driving at high speeds.
 - Driving with a window open.
 - When air from the ventilator blows directly toward the microphone.
 - The sound of the air conditioning fan is loud.
 - There is a negative effect on sound quality due to the phone and/or network being used.

REGISTERING/CONNECTING A Bluetooth PHONE

To use the hands-free system for cellular phones, it is necessary to register a cellular phone with the system. (→P.52)

Bluetooth PHONE CONDITION DISPLAY

The condition of the Bluetooth phone appears on the upper right side of the screen. (→P.39)

USING THE PHONE SWITCH/MICROPHONE

► Steering switch

By pressing the phone switch, a call can be received or ended without taking your hands off the steering wheel.

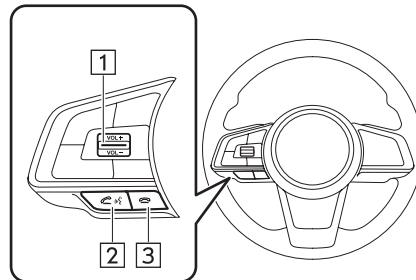

- 1 Volume control switch
 - Press the switch upwards to increase the volume.
 - Press the switch downwards to decrease the volume.
- 2 Off hook switch
- 3 On hook switch

► Microphone

The microphone is used when talking on the phone.

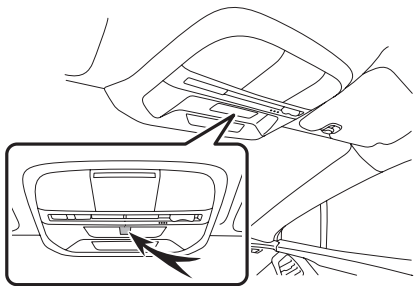
**VOICE RECOGNITION SYSTEM**

Press this switch to operate the voice recognition system.

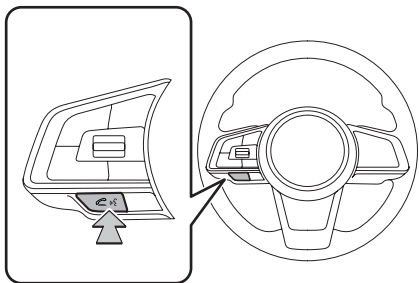

- The voice recognition system and its list of commands can be operated. (→P.213)

ABOUT THE CONTACTS IN THE CONTACT LIST

- The following data is stored for every registered phone. When another phone is connected, the following registered data cannot be read:
 - Contact data
 - Call history data
 - Favorites data
 - All phone settings

NOTE

- When a phone's registration is deleted, the above-mentioned data is also deleted.

WHEN SELLING OR DISPOSING OF THE VEHICLE

A lot of personal data is registered when the hands-free system is used. When selling or disposing of the vehicle, reset all setup items. (→P.63)

- The following data in the system can be reset:
 - Contact data
 - Call history data
 - Favorites data
 - All phone settings

NOTE

- Once reset, the data and settings will be erased. Pay close attention when resetting the data.

CALLING ON THE Bluetooth PHONE

After a Bluetooth phone has been registered, a call can be made using the hands-free system. There are several methods by which a call can be made, as described below.

1. Press .

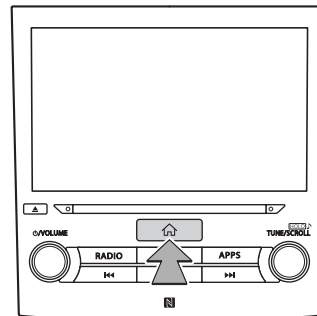

2. Select **Phone** (Phone).

3. Select the desired button to call from.

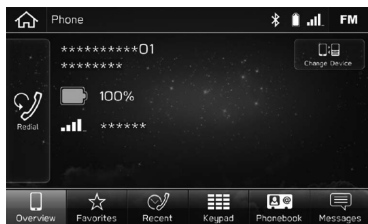

- 8-inch system only: The phone screen can be displayed by pressing **PHONE**.

How to make a call list	Page
By the last number	91
By favorites list	92
By recent calls list	92
By keypad*1	93
By contacts list	93
By SMS/MMS	102
By POI call*2	183, 184, 187
By voice recognition system	213

*1: The operation cannot be performed while driving.

*2: 8-inch with Navi system only

BY THE LAST NUMBER

Calls can be made using the latest call history item.

1. Display the phone screen. (→P.90)
2. Select **Overview** (Overview).
3. Select **Redial** (Redial).



4. Check that the "Calling" screen is displayed.

BY FAVORITES LIST

Calls can be made using registered contacts which can be selected from a contact list.

1. Display the phone screen. (→P.90)
2. Select **Favorites** (Favorites), and then select the desired contact.

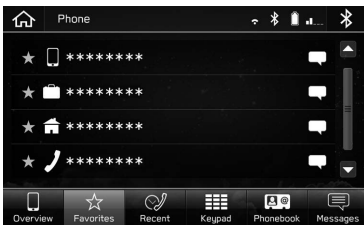

3. Check that the “Calling” screen is displayed.



NOTE

- This system’s favorites list and that of your Bluetooth phone are not synchronized. This system does not currently support transfer of favorites list data from the Bluetooth phone. To add the Bluetooth phone’s favorites list to the system’s favorites list, you need to register it through the system phonebook contacts list. (→P.93)

BY RECENT CALLS LIST

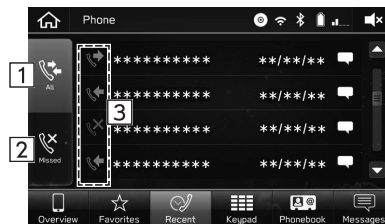
1. Display the phone screen. (→P.90)
2. Select **Recent** (Recent), and then select the desired contact.



No.	Information/Function
1	Select to display all latest call history items.
2	Select to display missed calls.
3	Displays the call type icons.  : Missed call  : Incoming call  : Outgoing call

3. Check that the “Calling” screen is displayed.

NOTE

- When a phone number registered in the contact list is received, the name is displayed.

NOTE

- International phone calls may not be made depending on the type of cellular phone you have.

BY KEYPAD

1. Display the phone screen. (→P.90)
2. Select **Keypad** (Keypad), and then enter the phone number.



3. Select **Call** (Call).
4. Check that the “Calling” screen is displayed.

NOTE

- Depending on the type of Bluetooth phone being connected, it may be necessary to perform additional steps on the phone.

BY CONTACTS LIST

Calls can be made by using contact data which is transferred from a registered cellular phone.

1. Display the phone screen. (→P.90)
2. Select **Phonebook** (Phonebook), and then select the desired contact.

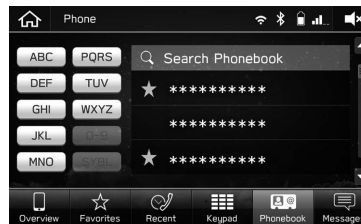

- A contact can be searched by entering the contact's name.

3. Select the desired number.

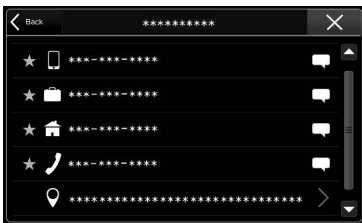

- 8-inch with Navi system only: When the address is selected, the search screen is displayed. (→P.183)
- Numbers may include home, work, and mobile as categories depending on the phonebook data of the connected cellular phone.
- When ☆ is selected, ☆ changes to ★ (yellow).
 - The number is registered in the favorites list. (→P.92)
- Each time the symbol is selected, the symbol changes between ☆ and ★ (yellow).

4. Check that the “Calling” screen is displayed.



NOTE

- When “Phonebook Download” is set to on, contacts is transferred automatically. (→P.61)



RECEIVING ON THE Bluetooth PHONE

INCOMING CALLS

When a call is received, the incoming call screen pops up with sound.

1. Select  or press the  switch on the steering wheel to talk on the phone.



To refuse to receive the call: Select  or press the  switch on the steering wheel.

To adjust the volume of a received call: Turn the “/VOLUME” knob, or use the volume control switch on the steering wheel.

NOTE

- During international phone calls, the other party's name or number may not be displayed correctly depending on the type of cellular phone you have.
- The ringtone volume can also be set from the sound settings screen.(→P.77)

TALKING ON THE Bluetooth PHONE

While talking on the phone, this screen is displayed. The operations outlined below can be performed on this screen.



No.	Function
1	Select to transfer the call. Select Transfer (Transfer) to change from a hands-free call to a cellular phone call. Select Transfer Back (Transfer Back) to change from cellular phone call to hands-free call.
2	Select to put a call on hold.
3	Select to mute your voice to the other party.
4	Select to hang up the phone.

NOTE

- Changing between cellular phone call and hands-free call can be performed by operating the cellular phone directly.
- Transferring methods and operations will be different depending on the type of cellular phone you have.
- For the operation of the cellular phone, see the manual that comes with it.
- Turn the “**VOLUME**” knob, or use the volume control switch on the steering wheel to adjust the volume of the other party’s voice.

SENDING TONES

BY KEYPAD



This operation cannot be performed while driving.

1. Select **Keypad** (Keypad).
2. Enter the desired number.





CALL WAITING

When a call is interrupted by a third party while talking, the incoming call screen pops up with sound.

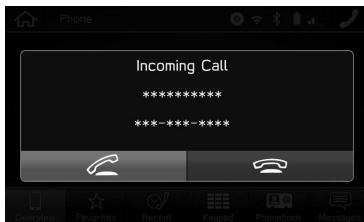
1. Select  or press the  switch on the steering wheel to start talking with the other party.





To refuse to receive the call: Select  or press the  switch on the steering wheel.

- The first call is put on hold.

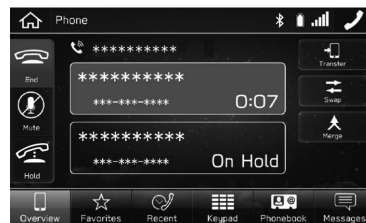
2. Check that the call waiting screen is displayed.



- **Swap** (Swap): Select to change parties. Each time **Swap** (Swap) is selected, the party who is on hold will be switched.
- **Merge** (Merge): Select to change to a conference call.
- Select  or press the  switch on the steering wheel to end the call and return to the conversation with the party on hold when having a two-way conversation, and to end the call with both parties when having a three-way conversation.

Bluetooth PHONE MESSAGE FUNCTION

Received messages can be forwarded from the connected Bluetooth phone, enabling checking and replying using the system.

Depending on the type of Bluetooth phone connected, received messages may not be transferred to the message inbox.

If the phone does not support the message function, this function cannot be used.

Depending on the Bluetooth phone type, the screen display may differ, and it may not be possible to use certain functions.

To use this function, it is necessary to set the phonebook download function to on. (→P.61)

NOTE

- Depending on the model of your Bluetooth phone, the setting of the connected phone may need to be changed. (ex: For iOS or other models, the notification setting may need to be activated.) For details, check the instructions for the connected Bluetooth phone.

1. Press .

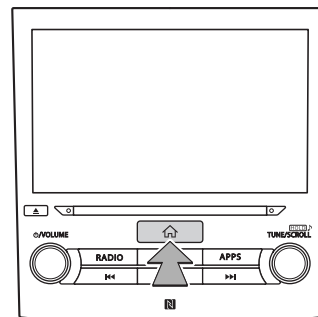

2. Select **Phone** (Phone).
3. Select **Messages** (Messages).
 - 8-inch system only: The phone screen can be displayed by pressing **PHONE**.

4. Check that the message inbox screen is displayed.

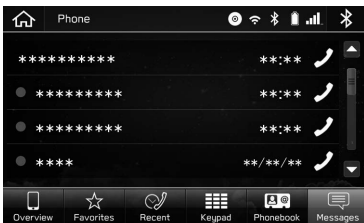

● : Unread message icon

Function	Page
Receiving a message	98
Checking messages	99
Replying to a message (quick reply)	100
Sending a new short message	101
Calling the message sender	102

RECEIVING A MESSAGE

When an SMS/MMS is received, the incoming message screen pops up with sound and is ready to be operated on the screen.

1. Select **Play** (Play) to have messages read out.

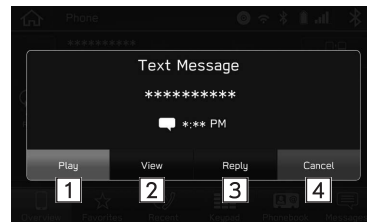

No.	Function
1	Select to read out the message.
2	Select to check the message.
3 *	Select to reply the message. (→P.100)
4	Select to cancel this function.

*: Depending on the Bluetooth phone that is connected to the audio system, this function is not available.

► If there are any unread messages



- **Inbox** (Inbox): Select to display the message inbox screen.
- **Ignore** (Ignore): Select to not open the message.

NOTE

- Depending on the cellular phone used for receiving messages, or its registration status with the system, some information may not be displayed.
- When multiple text messages are received, a pop-up screen displays. Select **Messages** (Messages) to store the messages in the message inbox.

CHECKING MESSAGES

1. Display the message inbox screen. (→P.97)
2. Select the desired message from the list.
3. Select **View** (View).

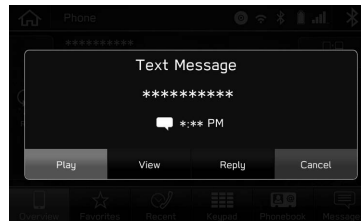

4. Check the message.

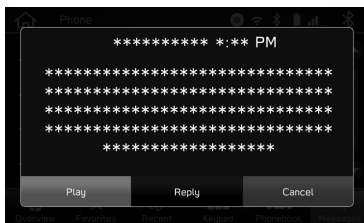

- **Play** (Play): Select to have messages read out.
- **Reply** (Reply)*: Select to reply the message. (→P.100)
- **Cancel** (Cancel): Select to cancel this function.

*: Depending on the Bluetooth phone that is connected to the audio system, this function is not available.

NOTE

- Depending on the type of Bluetooth phone being connected, it may be necessary to perform additional steps on the phone.
- Only received messages on the connected Bluetooth phone can be displayed.
- The text of the message is not displayed while driving.
- Turn the “**VOLUME**” knob, or use the volume control switch on the steering wheel to adjust the message readout volume.

REPLYING TO A MESSAGE (QUICK REPLY)*

*: Depending on the Bluetooth phone that is connected to the audio system, this function is not available.

1. Display the message inbox screen. (→P.97)
2. Select the desired message from the list.
3. Select **Reply** (Reply).

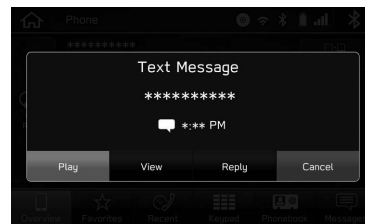

4. Select the desired message.



5. Select **Send** (Send).

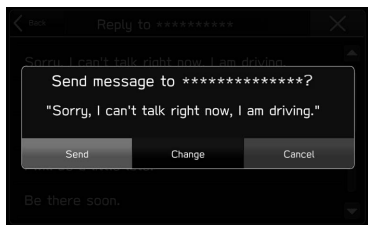

- **Change** (Change): Select to change the message.
- **Cancel** (Cancel): Select to cancel sending the message.

NOTE

- 10 messages have already been stored.

SENDING A NEW SHORT MESSAGE

1. Display the favorites list screen (→P.92), the recent calls list screen (→P.92) or the contact detail screen (→P.93).
2. Select  next to the desired number.
3. Select the desired message.



4. Select **Send** (Send).

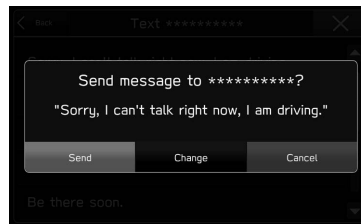

- **Change** (Change): Select to change the message.
- **Cancel** (Cancel): Select to cancel sending the message.

CALLING THE MESSAGE SENDER

Calls can be made to an SMS/MMS message sender's phone number.

1. Display the message inbox screen. (→P.97)
2. Select  next to the desired sender.
3. Check that the "Calling" screen is displayed.

5 Apps

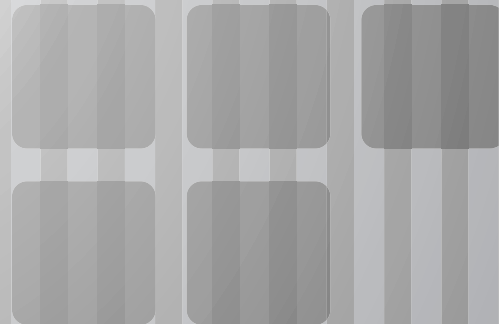

Before Using Applications 104

Before Using Applications	104
Settings Required To Use Applications	105
About App-based Connected Content	105

SUBARU STARLINK 107

SUBARU STARLINK	107
Displaying SUBARU STARLINK Information ..	107
Legal Notice	108

aha™ by HARMAN 112

aha™ by HARMAN	112
Overview	112

Pandora® 116

Pandora®	116
Overview	116

Apple CarPlay 119

Apple CarPlay	119
Overview	119

Android Auto 121

Android Auto	121
Overview	121

SiriusXM Travel Link 123

SiriusXM Travel Link	123
Displaying Sports Information	123
Displaying Weather Information	124
Displaying Stocks Information	125
Displaying Fuel Information	125

BEFORE USING APPLICATIONS

BEFORE USING APPLICATIONS

Precautions to be aware of when using applications are shown below.

In this chapter, iPhone or Android devices will be referred to as a smartphone.

 **WARNING**

- Do not connect or operate the smartphone while driving.
- Be sure to park the vehicle in a safe place before connecting or operating the smartphone.

 **CAUTION**

- Do not leave your smartphone in the vehicle. In particular, high temperatures inside the vehicle may damage the smartphone.
- Do not push down on or apply unnecessary pressure to the smartphone while it is connected as this may damage the smartphone or its terminal.
- If connecting your smartphone via USB, do not insert foreign objects into the USB port as this may damage the smartphone or its terminal.

NOTE

- Depending on the application, certain functions are not available while driving for reasons of safety.
- In order to maximize signal reception, performance and precision of the smartphone, please ensure the smartphone is placed as close to the system as possible, while ensuring it is stowed and secure while driving.
- When connecting your smartphone via USB, use the original cables provided with your smartphone or equivalent third-party (certified) cables.
- When the ignition switch is in the “ACC” or “ON” position, the battery of the connected smartphone is charged.
- If connecting your smartphone via USB, smartphone may not be recognized when the ignition switch is in the “ACC” or “ON” position. In this case, remove the smartphone and reconnect it.
- The accuracy of the displayed information or the signal reception performance depends on the smartphone or the connected device, and its wireless connection.
- For operating the smartphone, see the instruction manual that comes with it.
- Follow the specific operation procedures for the smartphone application.
- When connecting the device via Bluetooth, the communication speed may become slower than via USB.
- If the application is not running smoothly or is unstable, disconnect and reconnect the smartphone via Bluetooth (→P.58) and/or USB cable (→P.34). If the problem continues, reboot the smartphone.

SETTINGS REQUIRED TO USE APPLICATIONS

In order to use an application on this system, the application must be installed on your smartphone.

- Search and download the application from your smartphone app.
 - iPhone: App Store via iTunes
 - Android device: Google Play Store
- Create an account and login to the application on the smartphone.

NOTE

- Please use the latest version of the application.
- Apple CarPlay does not require an application to be installed. Refer to “Apple CarPlay” for details on Apple CarPlay operation. (→P.119)

ABOUT APP-BASED CONNECTED CONTENT

Requirements for using the connected content services of the application on this system.

- The latest version of the system is compatible with connected content application(s) for the smartphones, and is downloaded to your smartphone.
- A current account with a wireless content service provider.
- A smartphone data plan: If the data plan for your smartphone does not provide for unlimited data usage, additional charges from your carrier may apply for accessing app-based connected content via 3G, 4G, Wi-Fi, or 4G LTE wireless networks.
- Connection to the internet via 3G, 4G, Wi-Fi, or 4G LTE networks.

NOTE

- Changes to product specifications may result in differences between the content of the manual and features of the product.
- Be careful not to exceed the data usage limits for your smartphone. Doing so will result in additional data usage charges from your phone carrier.

NOTE

- **Limitations:**
 - Access to app-based connected content will depend on the availability of wireless cellular and/or Wi-Fi network coverage for the purpose of allowing your smartphone to connect to the internet.
 - Service availability may be geographically limited by region. Consult the wireless connected content service provider for additional information.
 - Ability of this product to access connected content is subject to change without notice and could be affected by any of the following: compatibility issues with future firmware versions of the smartphone; compatibility issues with future versions of the connected content application(s) for the smartphone; changes to or discontinuation of the connected content application(s) or service by its provider.
- Since some applications use signals from GPS satellites and wireless communication lines, they may not work properly in the following locations.
 - In tunnels
 - In underground parking lots
 - Outside wireless communication range, such as some countryside areas
 - Where the wireless communication network is congested, or where communications are restricted
- Depending on the circumstances and environment, the signal may be weak or not be received. In such cases, an error may occur.

NOTE

- Communication and phone call charges for smartphones should be paid by the wireless subscriber.
- If you lose the data in a smartphone or other device while using it with the system, no compensation will be given for the lost data.
- SUBARU CORPORATION does not guarantee content provided by the application.
- The application may not work due to factors on smartphones, smartphone applications or stations. SUBARU CORPORATION accepts no responsibility for this.

SUBARU STARLINK

SUBARU STARLINK

The SUBARU STARLINK function allows the system to link with a smartphone either by Bluetooth or USB connection.

When connecting iPhone or Android devices with the SUBARU STARLINK application installed, you can control SUBARU STARLINK content through the system.

To use the SUBARU STARLINK application, connect your iPhone to the USB port or via Bluetooth, or connect your Android device via Bluetooth.

8-inch system only: It is necessary to pair your smartphone via Bluetooth (→P.58), set the phonebook download function to on (→P.61), and then adjust the time so that it is the same at both your smartphone and the system.

When using the application, read the precautions indicated in “BEFORE USING APPLICATIONS”. (→P.104)

NOTE

- SUBARU STARLINK may not be able to be used when connecting to an external Wi-Fi source from this system if the source IP address is 192.168.1.x.

DISPLAYING SUBARU STARLINK INFORMATION

1. Run the SUBARU STARLINK application on your smartphone.
2. Connect the iPhone to the USB port, or connect your iPhone or Android device by utilizing the Bluetooth connection.
 - For details on connecting your iPhone to the USB port: →P.34
For details on registering or connecting your iPhone or Android device: →P.52
3. Select **SUBARU STARLINK** (SUBARU STARLINK) on the “Apps” screen. (→P.26)

NOTE

- There may be times when **SUBARU STARLINK** (SUBARU STARLINK) does not appear immediately when the ignition switch is set in the “ACC” or “ON” position. If so, please wait.

ABOUT THE SUPPORTED DEVICES

This system supports the following devices.

- iPhone: iOS 9 or later
- Android: Android 4.0.3 or later

LEGAL NOTICE

► For iPhone

- Caution
For your safety, do not attempt to operate any feature of this device unless it is safe to do so without distraction from safe driving. This device is informational only. Check and abide by your local laws and always obey safe driving rules, and posted signs and signals. Operate this device only in locales in which it is legal. Read the instruction manual for proper operation of this device. This product uses the Smart Phone's data plan for features and services. Please consult carrier data plan usage, pricing, data overage charges, limitations and usage guidelines.
- Permission
You may be asked to provide your personal and/or non-personal information solely for the purpose specified.

- Warranty Disclaimer

Any use of this product (the "Product"), the STARLINK software, and any applications that are supported with the Product (collectively with the Product and the STARLINK software, the "Product System"), including any reliance upon any of the content displayed by the Product System, shall be at your sole risk. SUBARU CORPORATION and its subsidiaries ("SUBARU CORPORATION") disclaims any and all responsibility or liability for the accuracy, content, completeness, legality, reliability, or operability or availability of any information from the use of the Product System. The telecommunication network used and the particular version of the iPhone, Android or other smart phone (each, a "Smart Phone") and the related Apple iOS, Android OS or other smart phone OS (collectively, the Smart Phone and the OS, the "Phone System") used are the responsibility of the customer, and SUBARU CORPORATION shall have no responsibility for the interoperability of the Product System with any telecommunications network/Phone System combination not explicitly supported by SUBARU CORPORATION in written documentation of the Product System.

The user's sole and exclusive remedies for any app downloaded from the iTunes Store, Google Play or other application stores (each, an "Application Store") (including the STARLINK app), or otherwise installed on customer's Smart Phone, shall be as provided in the Application Store Terms and Conditions or other similar document and SUBARU CORPORATION assumes no responsibility for those apps or their operation. Any services provided by the Product System shall be covered by a separate Services Agreement.

TO THE FULLEST EXTENT PERMITTED UNDER APPLICABLE LAW, THE PRODUCT SYSTEM IS PROVIDED "AS IS" AND "AS AVAILABLE," WITHOUT WARRANTY OF ANY KIND, EITHER EXPRESS OR IMPLIED OR STATUTORY, INCLUDING THE IMPLIED WARRANTIES OF MERCHANTABILITY, FITNESS FOR A PARTICULAR PURPOSE, OR NON-INFRINGEMENT. SUBARU CORPORATION AND ITS AFFILIATES, OFFICERS, EMPLOYEES, AGENTS, PARTNERS, SUPPLIERS AND LICENSORS (COLLECTIVELY, "SUBARU CORPORATION PARTIES") DISCLAIM ANY AND ALL WARRANTIES REGARDING THE SECURITY, RELIABILITY, TIMELINESS, COMPLETENESS, ACCURACY AND PERFORMANCE OF THE PRODUCT SYSTEM. SUBARU CORPORATION PARTIES DO NOT WARRANT OR COVENANT THAT ANY DEFECTS OR ERRORS ASSOCIATED WITH THE PRODUCT SYSTEM WILL BE CORRECTED, OR THAT THE PRODUCT SYSTEM IS FREE OF VIRUSES, ERRORS, OR OTHER HARMFUL COMPONENTS, OR WILL OPERATE UNINTERRUPTED OR ON ANY SCHEDULE. BECAUSE SOME JURISDICTIONS DO NOT ALLOW THE EXCLUSION OF IMPLIED WARRANTIES, THE ABOVE EXCLUSION OF IMPLIED WARRANTIES MAY NOT APPLY TO YOU.

► For Android devices

- Caution

For your safety, do not attempt to operate any feature of this device unless it is safe to do so without distraction from safe driving. This device is informational only. Check and abide by your local laws and always obey safe driving rules, and posted signs and signals. Operate this device only in locales in which it is legal. Read the instruction manual for proper operation of this device. This product uses the Smart Phone's data plan for features and services. Please consult carrier data plan usage, pricing, data overage charges, limitations and usage guidelines.

- Permission

You may be asked to provide your personal and/or non-personal information solely for the purpose specified.

- Warranty Disclaimer

Any use of this product (the "Product"), the STARLINK software, and any applications that are supported with the Product (collectively with the Product and the STARLINK software, the "Product System"), including any reliance upon any of the content displayed by the Product System, shall be at your sole risk. SUBARU CORPORATION and its subsidiaries ("SUBARU CORPORATION") disclaims any and all responsibility or liability for the accuracy, content, completeness, legality, reliability, or operability or availability of any information from the use of the Product System. The telecommunication network used and the particular version of the iPhone, Android or other smart phone (each, a "Smart Phone") and the related Apple iOS, Android OS or other smart phone OS (collectively, the Smart Phone and the OS, the "Phone System") used are the responsibility of the customer, and SUBARU CORPORATION shall have no responsibility for the interoperability of the Product System with any telecommunications network/Phone System combination not explicitly supported by SUBARU CORPORATION in written documentation of the Product System.

The user's sole and exclusive remedies for any app downloaded from the iTunes Store, Google Play or other application stores (each, an "Application Store") (including the STARLINK app), or otherwise installed on customer's Smart Phone, shall be as provided in the Application Store Terms and Conditions or other similar document and SUBARU CORPORATION assumes no responsibility for those apps or their operation. Any services provided by the Product System shall be covered by a separate Services Agreement.

TO THE FULLEST EXTENT PERMITTED UNDER APPLICABLE LAW, THE PRODUCT SYSTEM IS PROVIDED "AS IS" AND "AS AVAILABLE," WITHOUT WARRANTY OF ANY KIND, EITHER EXPRESS OR IMPLIED OR STATUTORY, INCLUDING THE IMPLIED WARRANTIES OF MERCHANTABILITY, FITNESS FOR A PARTICULAR PURPOSE, OR NON-INFRINGEMENT. SUBARU CORPORATION AND ITS AFFILIATES, OFFICERS, EMPLOYEES, AGENTS, PARTNERS, SUPPLIERS AND LICENSORS (COLLECTIVELY, "SUBARU CORPORATION PARTIES") DISCLAIM ANY AND ALL WARRANTIES REGARDING THE SECURITY, RELIABILITY, TIMELINESS, COMPLETENESS, ACCURACY AND PERFORMANCE OF THE PRODUCT SYSTEM. SUBARU CORPORATION PARTIES DO NOT WARRANT OR COVENANT THAT ANY DEFECTS OR ERRORS ASSOCIATED WITH THE PRODUCT SYSTEM WILL BE CORRECTED, OR THAT THE PRODUCT SYSTEM IS FREE OF VIRUSES, ERRORS, OR OTHER HARMFUL COMPONENTS, OR WILL OPERATE UNINTERRUPTED OR ON ANY SCHEDULE. BECAUSE SOME JURISDICTIONS DO NOT ALLOW THE EXCLUSION OF IMPLIED WARRANTIES, THE ABOVE EXCLUSION OF IMPLIED WARRANTIES MAY NOT APPLY TO YOU.

aha™ by HARMAN

aha is a cloud-based application that connects to the system and gives you access to your favorite web content safely and easily. There are several tens of thousands of stations spanning internet radio, personalized music, audiobooks, Facebook, Twitter, restaurant and hotel searches, weather and more. For more about aha, go to the aha site (<http://www.aharadio.com>).

When connecting iPhone or Android devices with the aha application installed, you can control, view, and hear aha content through the system.

To use the aha application, connect your iPhone or Android device via Bluetooth.

When using the application, read the precautions indicated in "BEFORE USING APPLICATIONS". (→P.104)

With navigation function: You may also display POI information from the aha application on the map screen and route to these POIs.

OVERVIEW

The aha™ by HARMAN operation screen can be accessed with the following methods:

- Run the aha application on your smartphone.
- Connect the iPhone or Android device by utilizing the Bluetooth connection.
 - For details on registering or connecting an iPhone or Android device: →P.52
- Select **Aha** (Aha) on the "Apps" screen. (→P.26)

► Control panel

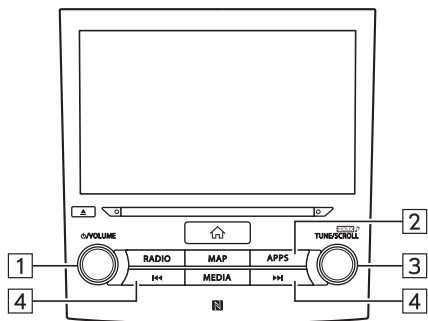

No.	Function
1	Turn to adjust volume. Press to mute the audio system and pause playback. Press and hold to turn the audio system off, and press to turn it on again.
2	Press to display the “Apps” screen.
3	Turn to display the next/previous content item. Press to select an item.
4	Press to display the next/previous content item.

► Control screen



<Top screen>

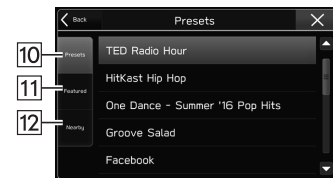

<Station list screen>

No.	Function
1	Displays cover art.
2	Displays station name.
3	Select to display the station list screen.
4	Select to display the track list screen.
5	Select to adjust the sound settings. (→P.130)



No.	Function
6	Top screen operation buttons <ul style="list-style-type: none"> • Content items can be changed, and if content items contain information, calls can be placed and content items can be set* for destinations, etc.
7	Shows progress.
8	Select to upload “Dislike” information to the application server. To cancel “Dislike” information that is being uploaded to the server, select this button again.
9	Select to upload “Like” information to the application server. To cancel “Like” information that is being uploaded to the server, select this button again.
10	Select to display a list of preset stations.
11	Select to display a list of featured stations.
12	Select to display a list of stations using the location information.

*: 8-inch with Navi system only

NOTE

- When you switch to other modes with the aha application activated and then turn the system Off/On with the smartphone device still connected, the home screen will display.
- Top 35 entries in the preset station list on the smartphone are displayed. When there are more than 35 entries in the preset station list, change the order of the entries in the list on the smartphone. You can change the priority of your preset stations within the aha application (after disconnected from this system) to modify the station list shown on the screen. Please see your smartphone aha application “Edit Presets” to modify this list.
- If there are multiple audio files stored on your iPhone, it may take some time until playback starts.
- Playback may be intermittent when you switch to streaming Bluetooth audio from aha on your smartphone device.
- The following operations are not available on this system. Perform these operations on the smartphone.
 - Add/Reorder/Delete stations
 - Log in to Facebook/Twitter (When not logged in, login will be required by the station. It is necessary to do so when the device is disconnected from the system.)
- For the aha function, the following touch screen gestures are not available.
 - Double touch with one finger
 - Double touch with two fingers
- The audio system will turn off when the aha application is closed on the iPhone and/or Android device.
- Use this system to play music with the aha application. If the station or settings are changed frequently via both the audio system and the smartphone, the aha application may not function. Restarting the application from the smartphone may be needed.

ABOUT THE SUPPORTED DEVICES FOR aha

This system supports the following devices.

- iPhone: iOS 11 or later
- Android: Android 3 or later

NOTE

- Note that the warranty does not apply if an unsupported iPhone is connected.
- The available functions may vary depending on the type of Android device.

Pandora®

Pandora is free personalized radio that offers effortless and endless music enjoyment and discovery.

To use the Pandora application, connect your iPhone or Android device via Bluetooth.

Depending on differences between models or software version etc., some models might be incompatible with this system.

The Pandora application must be installed on your smartphone.

When using the application, read the precautions indicated in “BEFORE USING APPLICATIONS”. (→P.104)

NOTE

- Pandora is only available in certain countries. Please visit pandora.com/legal for more information.

OVERVIEW

The Pandora operation screen can be accessed with the following methods:

- Connect the iPhone or Android device by utilizing the Bluetooth connection.
 - For details on registering or connecting an iPhone or Android device: →P.52
- Select **Pandora** (Pandora) on the “Apps” screen. (→P.26)

► Control panel

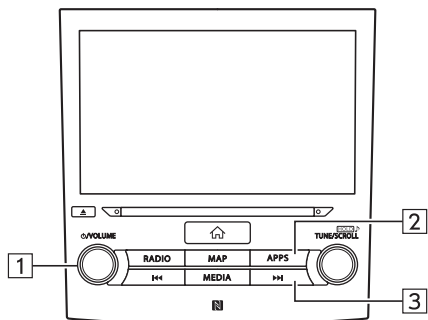

No.	Function
1	Turn to adjust volume. Press to mute the audio system and pause playback. Press and hold to turn the audio system off, and press to turn it on again.
2	Press to display the “Apps” screen.
3	Press to skip to the next track. Press and hold to fast forward.

► Control screen



No.	Function
1	Displays cover art.
2	Select to display the station list screen.
3	Select to adjust the sound settings. (→P.130)
4	Select to create a station from artist or track.
5	Select to bookmark the track currently playing.

No.	Function
6	Select to skip to the next track.
7	Shows progress.
8	Select to pause/play.
9	Select to rate the track currently playing as “Like” or “Dislike”.

NOTE

- Use this system to play music with the Pandora application. If the station or settings are changed frequently via both the audio system and the smartphone, the Pandora application may not function. Restarting the application from the smartphone may be needed.

ABOUT THE SUPPORTED DEVICES

This system supports the following devices.

- iPhone: iOS 11 or later
- Android: Android 4.1.1 or later

Apple CarPlay

Apple CarPlay

CarPlay can be used to view iPhone maps, play music, and place calls by connecting your iPhone to the system. Supported applications can also be run.

- For details on the services or the operations, check the Apple CarPlay site (<https://ssl.apple.com/ios/carplay/>).

To use the Apple CarPlay application, connect your iPhone to the USB port.

When using the application, read the precautions indicated in “BEFORE USING APPLICATIONS”. (→P.104)

NOTE

- Use an undamaged genuine cable when using this function.
- Turn on Apple CarPlay on your iPhone’s Restrictions settings when using this function.
- While using Apple CarPlay, some functions of this system may not operate.

OVERVIEW

The Apple CarPlay operation screen can be accessed with the following methods:

- Connect your iPhone to the USB port.
 - For details on connecting your iPhone to the USB port: →P.34
- Select **Apple CarPlay** (Apple CarPlay) on the “Apps” screen. (→P.26)

► Control panel

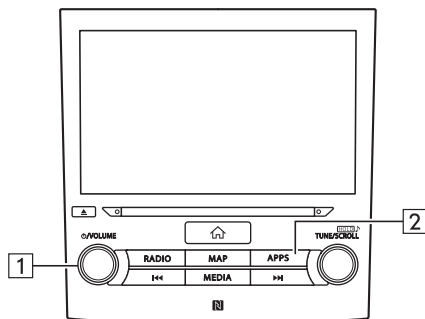

No.	Function
1	Turn to adjust volume. Press to mute the audio system and pause playback. Press and hold to turn the audio system off, and press to turn it on again.
2	Press to display the “Apps” screen.

► Control screen*



*: The displayed screen will differ depending on the connected iPhone.

No.	Function
1	Displays the application buttons. Select to start the application.
2	Select to change the home screen of Apple CarPlay.
3	Select to exit Apple CarPlay.

ABOUT THE SUPPORTED DEVICES

This system compatible with iOS 7.0 or later are supported.

Android Auto

Android Auto

Android Auto can be used to view Android maps, play music, and place calls by connecting your Android device to the system. Supported applications can also be run.

- For details on the services or the operations, check the Android Auto site (<https://www.android.com/auto/>) and (<https://support.google.com/androidauto/>).

To use the Android Auto application, connect your Android device to the USB port.

When using the application, read the precautions indicated in “BEFORE USING APPLICATIONS”. (→P.104)

NOTE

- Use an undamaged genuine cable when using this function.
- To use this function, check to make sure that your Android device is set to accept connection with a new vehicle.
- While using Android Auto, some functions of this system may not operate.

OVERVIEW

The Android Auto operation screen can be accessed with the following methods:

- Connect your Android device to the USB port.
 - For details on connecting your Android device to the USB port: →P.34
- Select **Android Auto** (Android Auto) on the “Apps” screen. (→P.26)

► Control panel

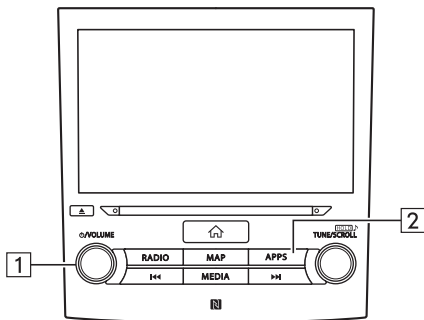

No.	Function
1	Turn to adjust volume. Press to mute the audio system and pause playback. Press and hold to turn the audio system off, and press to turn it on again.
2	Press to display the “Apps” screen.

► Control screen

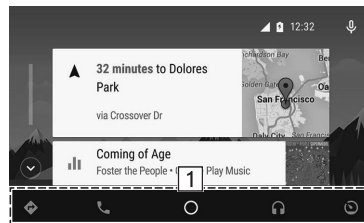

No.	Function
1	Displays the application/information buttons. Select to start the application, or select to display information.

ABOUT THE SUPPORTED DEVICES

This system compatible with Android 5.0 or later are supported.

SiriusXM Travel Link

SiriusXM Travel Link*

*: SiriusXM U.S. satellite and data services are available only in the 48 contiguous USA and DC. SiriusXM satellite service is also available in Canada; see www.siriusxm.ca.

Data service information, which is comprised of sports information, weather information, stock information and fuel information, can be received via the SiriusXM® Radio.

To receive the data service information in the vehicle, a subscription to the SiriusXM® Satellite Radio Service is necessary following a free trial. (→P.139)

Content that uses the SiriusXM® Satellite Radio Service is reset when personal information is initialized by selecting **Factory Data Reset** (Factory Data Reset) at the “GENERAL SETTINGS SCREEN”. (→P.63)

DISPLAYING SPORTS INFORMATION

By registering your favorite team, sports information such as games and results, the status of games still in progress, and future game schedules can be displayed.

1. Select **Travel Link** (Travel Link) on the “Apps” screen. (→P.26)
2. Select **Sports** (Sports).
3. Check that sports information is displayed.



No.	Function
1	Select to change the displayed information.
2	Sports information is displayed.
3	Select to set which sports information is displayed.
4	Select to edit or register your favorite team.

DISPLAYING WEATHER INFORMATION

Weather forecasts, forecast temperature or highest/lowest temperature, and the chances of precipitation, etc. can be displayed in weather information.

1. Select **Travel Link** (Travel Link) on the “Apps” screen. (→P.26)
2. Select **Weather** (Weather).
3. Check that weather information is displayed.

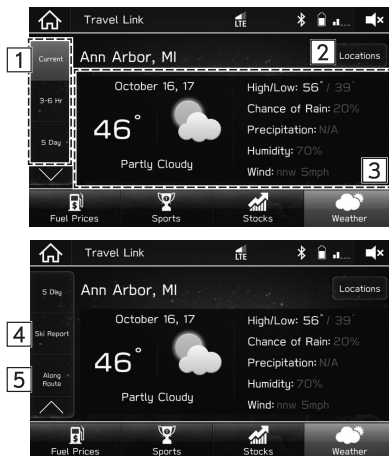

No.	Function
1	Select to switch the timing of the displayed forecast.
2	Select to set the forecast region. 8-inch with Navi system only: The weather forecast from your current location to your destination can also be displayed.
3	Weather information is displayed.
4	Select to display the ski facility operating status, weather, temperature, and snow depth, etc.
5 *	Select to display the weather forecast for the route being travelled during route guidance.

*: 8-inch with Navi system only

DISPLAYING STOCKS INFORMATION

Company names, stock prices, and price fluctuations can be displayed in stock information. Fluctuations greater than zero are displayed with green arrows, and fluctuations less than zero are displayed with red arrows.

1. Select **Travel Link** (Travel Link) on the “Apps” screen. (→P.26)
2. Select **Stocks** (Stocks).
3. Check that stock information is displayed.

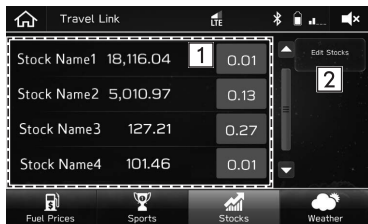

No.	Function
1	Stock information is displayed.
2	Select to add or edit stocks.

DISPLAYING FUEL INFORMATION

Gas station information can be displayed, and gas stations can be set* as the destination. When Bluetooth is enabled on your cellular phone, calls can be placed if the displayed information screen contains phone number information.

*: 8-inch with Navi system only

1. Select **Travel Link** (Travel Link) on the “Apps” screen. (→P.26)
2. Select **Fuel Prices** (Fuel Prices).
3. Check that fuel information is displayed.

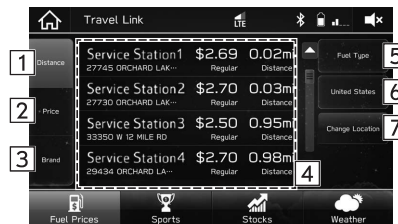

No.	Function
1 *1	Select to sort gas station by distance from the current position.
2	Select to sort gas station by price.

No.	Function
3	Select to sort gas station by brand.
4	Gas station information is displayed.
5	Select to set the fuel type.
6 *2	Select to change between the United States and Canada.
7 *3	Select to change the location in which fuel information is displayed.

*1: 8-inch with Navi system only

*2: If equipped

*3: 8-inch system only

6 Audio



Basic Operation 128

Some Basics	128
Turning The System On And Off	128
Selecting An Audio Source	129
Sound Settings	130
Voice Recognition System	131

Radio Operation 132

AM/FM Radio	132
Overview	132
Presetting A Station	134
Radio Broadcast Data System	134
Available HD Radio™ Technology	134
Caching Radio Programs	136

SiriusXM® Satellite Radio	138
Overview	138
How To Subscribe To SiriusXM® Satellite Radio	139
Displaying The Radio ID	142
Presetting A Channel	142
Caching Radio Programs	142
Searching By Featured Favorites	143
Selecting A Channel From The List	144
Setting Teams For Notifications	145
Setting Tune Mix Channels	146
Setting The Traffic & Weather	148

Media Operation 149

CD	149
Overview	149
USB Memory	151
Overview	151

iPod	153
Overview	153
Bluetooth Audio	156
Overview	156
Connecting A Bluetooth Device	159
AUX	159
Overview	159

Audio Remote Controls 161

Steering Wheel Controls	161
--------------------------------------	-----

Tips For Operating The Audio System 163

Operating Information	163
Radio	163
CD Player And Disc	165
USB Memory Device	168
iPhone/iPod	168
File Information	168

BASIC OPERATION

SOME BASICS

This section describes some of the basic features of the audio system. Some information may not pertain to your system.

Your audio system works when the ignition switch is turned to the “ACC” or “ON” position.

 **CAUTION**

- To prevent the battery from being discharged, do not leave the audio system on longer than necessary when the engine is not running.

NOTE

- The audio system upgrade accessory (dealer option) only works when the ignition switch is in the “ACC” or “ON” position. No audio is output from the amplifier when the ignition switch is “OFF”.

TURNING THE SYSTEM ON AND OFF

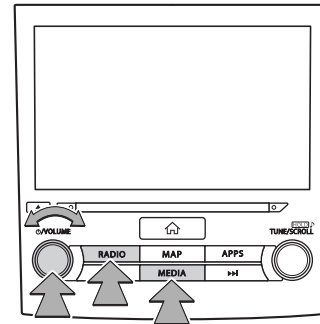

“/VOLUME” knob: Press and hold to turn the audio system off, and press to turn it on again. The system turns on in the last mode used. Turn this knob to adjust the volume. Press to mute the audio system.

RADIO, **MEDIA**: Press to display screen buttons for the audio system.

NOTE

- The audio system will remain off if you change the position of the ignition switch from “LOCK”/“OFF” to “ACC”/“ON” while the audio system is off. If you had set the volume to mute, then the track will start playing from where it was last stopped.

SELECTING AN AUDIO SOURCE

1. Press **RADIO** or **MEDIA**.

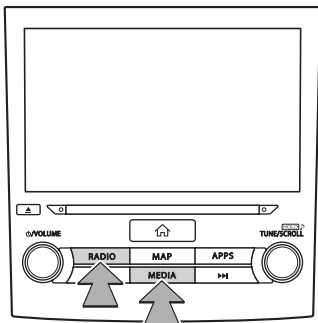

2. Select the desired audio source.

▶ “Radio” screen



▶ “Media” screen

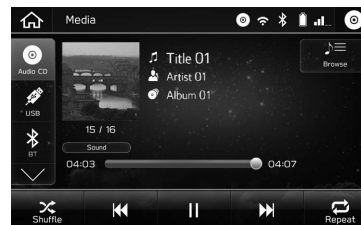

- Each time **RADIO** or **MEDIA** is pressed, the audio source can also be changed.

SOUND SETTINGS

The following sound quality can be adjusted.

TONE:

How good an audio program sounds is largely determined by the mix of the treble, mid and bass levels. In fact, different kinds of music and vocal programs usually sound better with different mixes of treble, mid and bass.

BALANCE:

A good balance of the left and right stereo channels and of the front and rear sound levels is also important.

Keep in mind that when listening to a stereo recording or broadcast, changing the right/left balance will increase the volume of 1 group of sounds while decreasing the volume of another.

1. Press .
2. Select **Settings** (Settings).
3. Select **Sound** (Sound).
4. Select **EQ and Sound Position** (EQ and Sound Position).

5. Set the desired item.

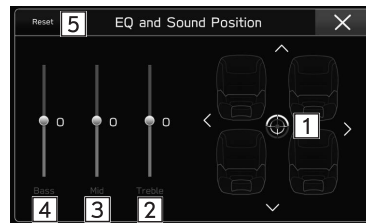

No.	Function
1	Select the icon to adjust sound balance.
2	Select the sliders to adjust high-pitched tones.
3	Select the sliders to adjust mid-pitched tones.
4	Select the sliders to adjust low-pitched tones.
5	Select to reset all setup items.

VOICE RECOGNITION SYSTEM

1. Press this switch to operate the voice recognition system.

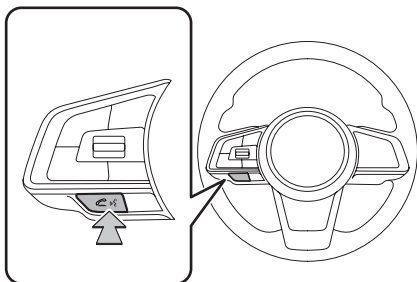

- The voice recognition system and its list of commands can be operated. (→P.213)

RADIO OPERATION

AM/FM RADIO

OVERVIEW

The FM/AM radio operation screen can be accessed by selecting **FM** (FM) or **AM** (AM) on the “Radio” screen. (→P.129)

► Control panel

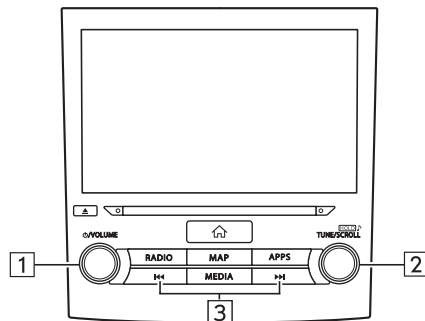

No.	Function
1	Turn to adjust volume. Press to mute the audio system. Press and hold to turn the audio system off, and press to turn it on again.
2	Turn to step up/down frequencies. Press and hold to display the sound settings screen. (→P.78)
3	Press to seek up/down available stations/channels.

► Control screen

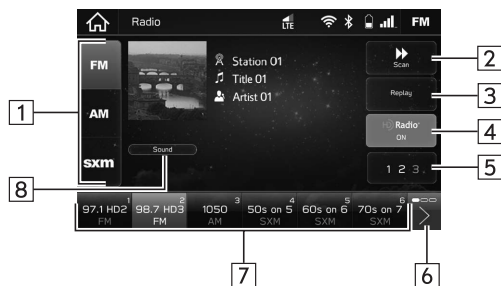

No.	Function
6	Select to scroll the list of preset buttons.
7	Select to tune to preset stations/channels. The preset station list can be scrolled by swiping the list.
8	Select to adjust the sound settings. (→P.130)

NOTE

- The radio automatically changes to stereo reception when a stereo broadcast is received.
- The radio automatically tunes to an HD Radio signal in AM or FM where available.

No.	Function
1	Select to change radio modes.
2	Select to scan for receivable stations/channels. The scan will continue until selected again.
3	Select to display the cache radio operation buttons. (→P.136)
4	Select to turn HD Radio mode on/off.
5	Select to change multicast channels available. (→P.135)

PRESETTING A STATION

Multiple stations can be registered as presets.

1. Tune in the desired station.
2. Select and hold one of the desired preset station buttons.



- To change the preset station to a different one, follow the same procedure.

RADIO BROADCAST DATA SYSTEM

This audio system is equipped with Radio Broadcast Data Systems (RBDS).

RBDS mode allows text messages to be received from radio stations that utilize RBDS transmitters.

RBDS features are available only when listening to an FM station that broadcasts RBDS information.

AVAILABLE HD Radio™ TECHNOLOGY

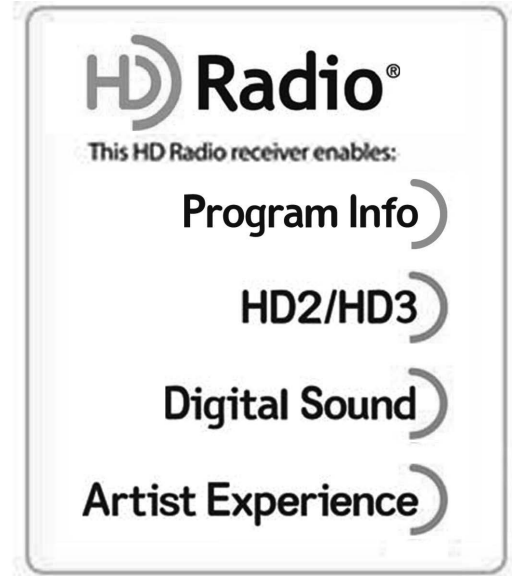

HD Radio Technology manufactured under license from iBiquity Digital Corporation. U.S. and Foreign Patents. HD Radio™ and the HD, HD Radio, and “Arc” logos are proprietary trademarks of iBiquity Digital Corp.

HD Radio™ Technology is the digital evolution of analog AM/FM radio. Your radio product has a special receiver which allows it to receive digital broadcasts (where available) in addition to the analog broadcasts it already receives. Digital broadcasts have better sound quality than analog broadcasts as digital broadcasts provide free, crystal clear audio with no static or distortion. For more information, and a guide to available radio stations and programming, refer to www.hdradio.com.

MULTICAST

On the FM radio frequency most digital stations have additional programs on one FM station.

1. Select .



- Each time  is selected, the channel can be changed.



Digital Sound

- HD Radio™ Technology improves the audio quality of your local stations and delivers a crystal clear digital signal to your receiver. HD Radio Technology enables local radio stations to broadcast a clean digital signal. AM sounds like today's FM and FM sounds like clear digital.

HD2/HD3

- FM stations can provide additional digital-only audio programming on HD2/HD3 Channels.
- EXAMPLE:
101.1 HD1
101.1 HD2
101.1 HD3

NOTE

- HD Radio™ stations can be preset.
- An orange  will be displayed on the screen when in digital. The  will first appear in a gray color indicating the digital station is being acquired. Once the digital signal is acquired, the logo will change to a bright orange color.
- The song title and artist name will appear on the screen when available by the radio station. The radio station can send album pictures when available.
- As a user works through the analog radio stations, (where applicable) the radio receiver will automatically tune from an analog signal to a digital signal within 5 seconds.

Program Info

- Program info provides song name, artist, station ID, and other relevant data to your receiver.

Artist Experience

- Visual images of album cover art and station logos are broadcasted with the audio to your receiver, such as Album Art, historical photographs, still art from live broadcasts, station logos, among other related content.

CACHING RADIO PROGRAMS

A radio program can be cached and played back in a time-shifted manner.

AUTOMATIC PLAYBACK OF THE CACHE

If the radio broadcast is interrupted by another audio output, such as an incoming phone call, the system will automatically cache the interrupted portion. To manually operate the cache operation: (→P.137)

NOTE

- The system can store up to 30 minutes. Cached data will be erased when the radio mode or station is changed or when the audio system is turned off.

PLAYING BACK THE CACHE MANUALLY

The broadcast cached in the program cache can be played back manually.

1. Select **Replay** (Replay). (→P.132)
2. Select the desired cache radio operation button.



No.	Information/Function
1	Shows the current playback location. The playback location can be changed by dragging the sliders.
2	Returns to the live radio broadcast.

No.	Information/Function
3	Select: Skips forward 10 seconds. Select and hold: Fast forwards continuously.
4	Pauses or plays the radio broadcast.
5	Select: Skips backward 10 seconds. Select and hold: Fast rewinds continuously.
6	Exits cached playback.

NOTE

- The time displayed on the bar scale may differ from the actual time.

Live Pause

- Allows HD Radio receivers to store content (songs/programs and data) in a buffer. Playback shall start at any point in the buffer and shall continue until the end of the buffer or until the user has selected to stop playback. Live Pause has the ability to store both analog and digital content in the buffer.

SiriusXM® Satellite Radio

OVERVIEW

The SiriusXM® operation screen can be accessed by selecting **sxm** (sxm) on the "Radio" screen. (→P.129)

► Control panel

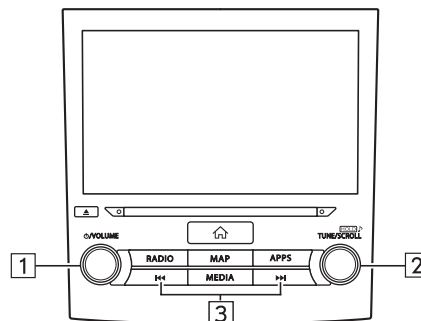

No.	Function
1	Turn to adjust volume. Press to mute the audio system. Press and hold to turn the audio system off, and press to turn it on again.
2	Turn to step up/down channels. Press and hold to display the sound settings screen. (→P.78)
3	Press to seek up/down available channels.

► Control screen

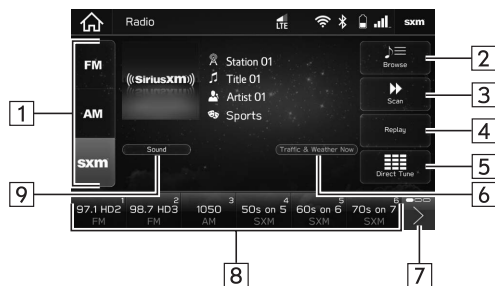

No.	Function
1	Select to change radio modes.
2	Select to search channels. (→P.144)
3	Select to search subscribed channels by category. To use this function, turn “Tune Start” off in “Sirius XM Settings” on the general settings screen. (→P.63)
4	Select to display the cache radio operation buttons. (→P.142)

No.	Function
5	Select to search channels by entering the channel number.
6	Select to play traffic and weather information. (→P.148)
7	Select to scroll the list of preset buttons.
8	Select to tune to preset stations/channels. The preset station list can be scrolled by swiping the list.
9	Select to adjust the sound settings. (→P.130)

HOW TO SUBSCRIBE TO SiriusXM® Satellite Radio

To listen to a satellite radio broadcast in the vehicle, a subscription to the SiriusXM® Satellite Radio service is necessary following a free trial.

A SiriusXM® Satellite Radio is a tuner designed exclusively to receive broadcasts provided under a separate subscription.

HOW TO SUBSCRIBE

SiriusXM audio services require a subscription sold separately, or as a package, by Sirius XM Radio Inc.

Subscription Details: Your SiriusXM service will automatically stop at the end of your trial unless you decide to subscribe. If you decide to continue service, the paid subscription plan you choose will automatically renew and you will be charged the rate in effect at that time and according to your chosen payment method. Fees and taxes apply. You may cancel at any time by calling 1-866-635-2349. See the SiriusXM Customer Agreement for complete terms at www.siriusxm.com. All fees and programming subject to change.

- For complete information on subscription rates and terms, or to subscribe to SiriusXM® Satellite Radio:

► U.S.A.

Refer to www.siriusxm.com or call
1-877-447-0011.

► Canada

Refer to www.siriusxm.ca or call
1-877-209-0079.

⚠ WARNING

● FCC WARNING

Changes or modifications not expressly approved by the party responsible for compliance could void the user's authority to operate the equipment.

● CAUTION: Radio Frequency Radiation Exposure

This equipment complies with FCC radiation exposure limits set forth for an uncontrolled environment and meets the FCC radio frequency (RF) Exposure Guidelines. This equipment should be installed and operated keeping the radiator at least 20cm or more away from person's body in normal use position.

- Co-location: This transmitter must not be co-located or operated in conjunction with any other antenna or transmitter.
- Explicit Language Notice — Channels with frequent explicit language are indicated with an "XL" preceding the channel name. Channel blocking is available for SiriusXM® Satellite Radio receivers by notifying SiriusXM at;

U.S.A. Customers:

Visit www.siriusxm.com or calling
1-877-447-0011

Canadian Customers:

Visit www.siriusxm.ca or calling
1-877-209-0079

CAUTION

- It is prohibited to copy, decompile, disassemble, reverse engineer, hack, manipulate, or otherwise make available any technology or software incorporated in receivers compatible with the SiriusXM® Satellite Radio Services or that support the SiriusXM website, the Online Service or any of its content. Furthermore, the AMBE® voice compression software included in this product is protected by intellectual property rights including patent rights, copyrights, and trade secrets of Digital Voice Systems, Inc.
- Note: this applies to SiriusXM® Satellite Radio receivers only and not SiriusXM Ready devices.

NOTE

- SiriusXM® Satellite Radio Services--Descriptions
 - Get over 175 channels of the best entertainment at the touch of a button, including commercial-free music, plus live games from every major sport, breaking news from around the world, and the best in comedy, talk and entertainment. More information about SiriusXM® Satellite Radio is available online at www.siriusxm.com (U.S.A.) or www.siriusxm.ca (Canada).

NOTE

- SiriusXM® Satellite Radio Services — Subscription Instructions
 - For SiriusXM Services requiring a subscription (such as SiriusXM® Satellite Radio Services, and some Infotainment & data services), the following paragraph shall be included. SiriusXM audio and data services each require a subscription sold separately, or as a package, by Sirius XM Radio Inc. The subscription plan you choose will automatically renew and you will be charged according to your chosen payment method at then-current rates. Fees and taxes apply. To cancel you must call Sirius XM at 1-866-635-2349. See SiriusXM Customer Agreement for complete terms at www.siriusxm.com. All fees and programming subject to change. © 2016 Sirius XM Radio Inc. Sirius, XM, SiriusXM and all related marks and logos are trademarks of Sirius XM Radio Inc. All other marks, channel names and logos are the property of their respective owners. All rights reserved. For more information, program schedules, and to subscribe or extend subscription after complimentary trial period; more information is available at:
USA Customers:
Visit www.siriusxm.com or call 1-877-447-0011
- Customers should have their radio ID ready; the radio ID can be found by tuning to channel "0" on the radio. For details, see "DISPLAYING THE RADIO ID" below.

DISPLAYING THE RADIO ID

Each SiriusXM tuner is identified with a unique radio ID which is 8 alphanumeric characters. The radio ID is required when activating SiriusXM Satellite Services or when reporting a problem.

The radio ID can be checked on the SiriusXM subscription screen (→P.63) or tune to channel “0”.

PRESETTING A CHANNEL

Multiple stations can be registered as presets.

1. Tune in the desired channel.
2. Select and hold one of the desired preset station buttons.



- To change the preset station to a different one, follow the same procedure.

CACHING RADIO PROGRAMS

A radio program can be cached and played back in a time-shifted manner.

The program that is currently being listened to can be cached.

PLAYING BACK THE CACHE

The broadcast cached in the program cache can be played back.

1. Select **Replay** (Replay). (→P.138)

2. Select the desired cache radio operation button.



No.	Information/Function
1	Shows the current playback location. The playback location can be changed by dragging the sliders.
2	Returns to the live radio broadcast.
3	Select: Access the desired program. Skips forward through program. Select and hold: Fast forwards continuously. The fast forward speed increases the longer the button is held down.

No.	Information/Function
4	Pauses or plays the radio broadcast.
5	Select: Access the desired program. Skips back through program. Select and hold: Fast rewinds continuously. The fast rewind speed increases the longer the button is held down.
6	Exits cached playback.

NOTE

- The time displayed on the bar scale may differ from the actual time.

SEARCHING BY FEATURED FAVORITES

Featured Favorites are a collection of channels that are created by the SiriusXM programming team that are updated several times throughout the year.

The desired Featured Favorite channel can be selected from the list screen. (→P.144)

SELECTING A CHANNEL FROM THE LIST

1. Select **Browse** (Browse).
2. Select the desired list, and then select the desired channel.

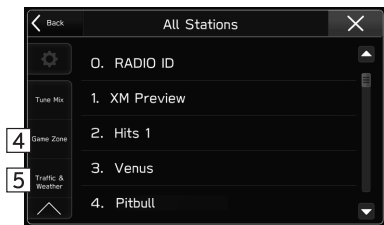
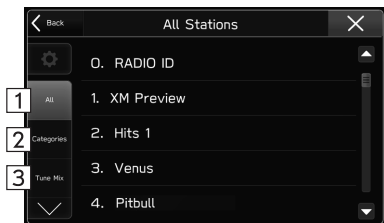

No.	Function	Page
1	Select to display the all channels list.	-
2	Select to display channel categories and Featured Favorite channel list.	144

No.	Function	Page
3	Select to display the tune mix channel.	146
4	Select to set teams for notifying the user of games starting and score updates.	145
5	Select to set the traffic and weather information.	148

SELECTING FROM CATEGORIES AND FEATURED FAVORITE CHANNEL LIST

1. Select **Categories** (Categories).

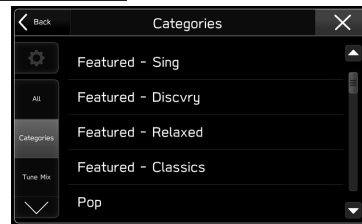

- Received Featured Favorite channels is listed on the top of the list.
2. Select the desired channel.

SETTING TEAMS FOR NOTIFICATIONS

By registering teams, a pop-up screen appears notifying listeners of information on the game progress and so on. You can return to the original point in the regular broadcast by exiting the pop-up screen.

To use this function, turn “Sports Flash” on in “Sirius XM Settings” on the general settings screen. (→P.63)

ADDING TEAMS

1. Select **Browse** (Browse).
2. Select **Game Zone** (Game Zone).
3. Select **Favorite Teams** (Favorite Teams).

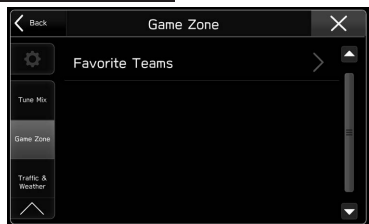

4. Select **Add Teams** (Add Teams).

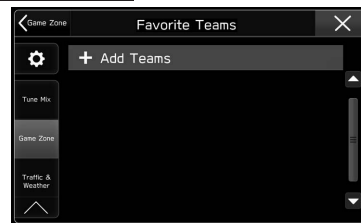

5. Select the desired league.



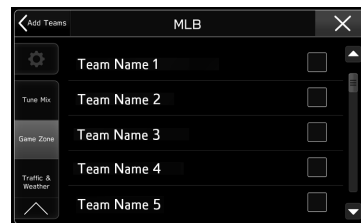

6. Select the desired team.



EDITING THE LIST

1. Select **Favorite Teams** (Favorite Teams) on the “Game Zone” screen. (→P.145)
2. Select .
3. Select the desired item to be set.



- : Select to delete the item.
- : Drag an item to the desired position.

SETTING POP-UP ALERTS

Pop-up alerts can be set to display on the screen.

1. Select **Favorite Teams** (Favorite Teams) on the “Game Zone” screen. (→P.145)
2. Select the desired item.

3. Select the desired item, and then select **Save** (Save).



SETTING TUNE MIX CHANNELS

Tracks on multiple set channels can be played randomly.

To use this function, it is necessary to register the desired channels to the preset channel. (→P.142)

REGISTERING CHANNELS

1. Select **Browse** (Browse).
2. Select **Tune Mix** (Tune Mix).

3. Select **Add Tune Mix** (Add Tune Mix).

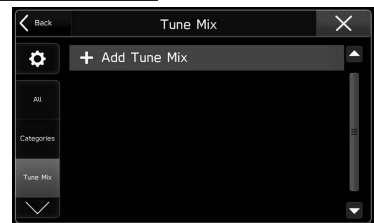

4. Select the desired channels from the preset channel list.



LISTENING TO TUNE MIXED CHANNELS

1. Select the desired channel on the "Tune Mix" screen.



EDITING THE TUNE MIX

1. Select **⚙** on the "Tune Mix" screen.



2. Select the desired item to be set.



- : Select to delete the item.

3. Select the desired channels from the preset channel list.

NOTE

- The Tune Mix name cannot be changed.

SETTING THE TRAFFIC & WEATHER

Traffic and weather information can be played for set cities.

SETTING THE TRAFFIC & WEATHER

1. Select **Browse** (Browse).
2. Select **Traffic & Weather** (Traffic & Weather).

3. Select the city.



LISTENING TO TRAFFIC AND WEATHER INFORMATION

1. Select **Traffic & Weather Now** (Traffic & Weather Now) on the control screen.



- When the latest information is received, **Traffic & Weather Now** (Traffic & Weather Now) changes to green.
- **Return** (Return): Select to return to the original channel.

MEDIA OPERATION

CD

OVERVIEW

The CD operation screen can be accessed with the following methods:

- Insert a disc. (→P.33)
- Select  on the “Media” screen. (→P.129)

► Control panel

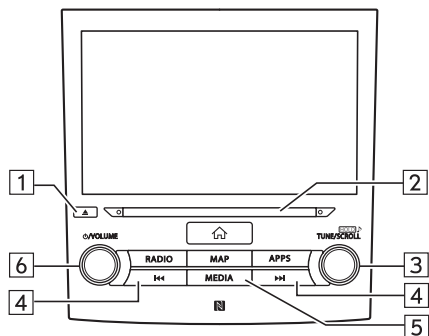

No.	Function
1	Press to eject a disc.
2	Disc slot
3	Turn to change a track. Press and hold to display the sound settings screen. (→P.78)
4	Press to change a track. Press and hold to fast forward/rewind.
5	Press to switch between media sources.
6	Turn to adjust volume. Press to mute the audio system and pause playback. Press and hold to turn the audio system off, and press to turn it on again.

► Control screen



No.	Function
1	Select to switch between other media sources.
2	Displays cover art.
3	Select to display the play mode selection screen. • Select  to narrow down the search for tracks in each play mode.
4	Shows progress. The playback location can be changed by dragging the sliders.

No.	Function
5	Changes between repeat current track → repeat current folder/album → cancel repeat each time this button is selected.
6	Select to change a track. Select and hold to fast forward/rewind.
7	Select to pause/play.
8	Select to enable/disable random playback for the tracks currently playing on the CD.
9	Select to adjust the sound settings. (→P.130)

NOTE

- If a disc contains CD-DA files and MP3/WMA/AAC files, only the CD-DA files can be played back.
- If a CD-TEXT disc is inserted, the title of the disc and track will be displayed.
- Depending on the disc or music file being played, the cover art may not be displayed.

USB MEMORY

Audio files on the USB memory device can be played back.

OVERVIEW

The USB Audio playback screen can be accessed with the following methods:

- Connect a USB memory device. (→P.34)
- Select  on the “Media” screen. (→P.129)

► Control panel

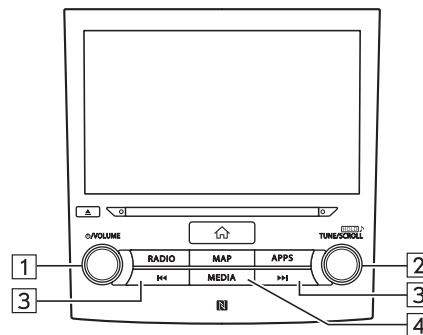

No.	Function
1	Turn to adjust volume. Press to mute the audio system and pause playback. Press and hold to turn the audio system off, and press to turn it on again.
2	Turn to change a track. Press and hold to display the sound settings screen. (→P.78)
3	Press to change a track. Press and hold to fast forward/rewind.
4	Press to switch between media sources.

► Control screen



No.	Function
4	Shows progress. The playback location can be changed by dragging the sliders.
5	Changes between repeat current track → repeat current folder/album → cancel repeat each time this button is selected.
6	Select to change a track. Select and hold to fast forward/rewind.
7	Select to pause/play.
8	Select to enable/disable random playback for the tracks currently playing from the USB memory device.
9	Select to adjust the sound settings. (→P.130)

No.	Function
1	Select to switch between other media sources.
2	Displays cover art.
3	Select to display the play mode selection screen. • Select  to narrow down the search for tracks in each play mode.

⚠ WARNING

- Do not operate the player's controls or connect the USB memory device while driving.

⚠ CAUTION

- Do not leave your portable player in the vehicle. In particular, high temperatures inside the vehicle may damage the portable player.
- Do not push down on or apply unnecessary pressure to the portable player while it is connected as this may damage the portable player or its terminal.
- Do not insert foreign objects into the port as this may damage the portable player or its terminal.

NOTE

- Depending on the device or music file being played, the cover art may not be displayed.

iPod

When an iPhone/iPod is connected, you can play iPhone/iPod music files. On this unit, you can perform operations such as selecting a file from a list or changing to the random playback mode.

At devices which support Apple CarPlay, turn Apple CarPlay off in the device side Restrictions settings.

OVERVIEW

The iPod operation screen can be accessed with the following methods:

- Connect an iPhone/iPod. (→P.34)
- Select  on the "Media" screen. (→P.129)

► Control panel

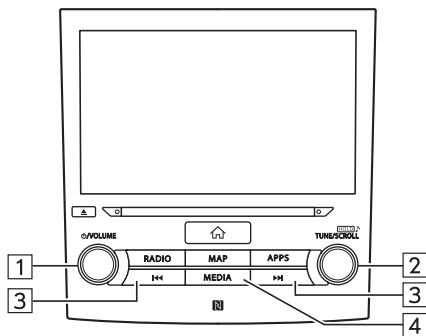

No.	Function
1	Turn to adjust volume. Press to mute the audio system and pause playback. Press and hold to turn the audio system off, and press to turn it on again.
2	Turn to change a track. Press and hold to display the sound settings screen. (→P.78)
3	Press to change a track. Press and hold to fast forward/rewind.
4	Press to switch between media sources.

► Control screen

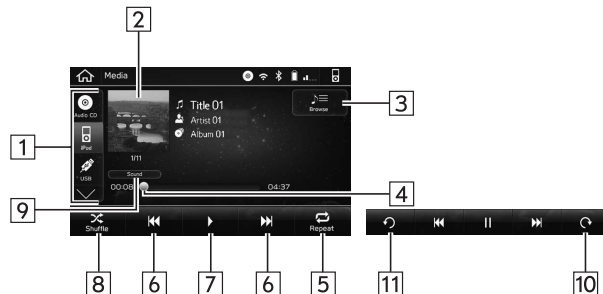

No.	Function
1	Select to switch between other media sources.
2	Displays cover art.
3	Select to display the play mode selection screen. • Select  to narrow down the search for tracks in each play mode.
4	Shows progress. The playback location can be changed by dragging the sliders.

No.	Function
5	Changes between repeat current track → repeat current album → cancel repeat each time this button is selected.
6	Select to change a track. Select and hold to fast forward/rewind.
7	Select to pause/play.
8	Select to enable/disable random playback for the tracks currently playing on the iPhone/iPod.
9	Select to adjust the sound settings. (→P.130)
10 *	Select to fast forward the current content item in fixed intervals.
11 *	Select to rewind the current content item in fixed intervals.

*: Display when playing Audiobooks or Podcasts

! WARNING

- Do not operate the player's controls or connect the iPhone/iPod while driving.

! CAUTION

- Do not leave your portable player in the vehicle. In particular, high temperatures inside the vehicle may damage the portable player.
- Do not push down on or apply unnecessary pressure to the portable player while it is connected as this may damage the portable player or its terminal.
- Do not insert foreign objects into the port as this may damage the portable player or its terminal.

NOTE

- When an iPhone/iPod is connected using a genuine iPhone/iPod cable, the iPhone/iPod starts charging its battery.
- If playing iPhone/iPod music, perform operation at the system. Certain functions may not be available if played directly from the iPhone/iPod. Furthermore, depending on the connected iPhone/iPod, certain functions may not be available.
- Depending on the iPhone/iPod or music file being played, the cover art may not be displayed.
- When an iPhone/iPod is connected and the audio source is changed to iPod mode, the iPhone/iPod will resume playing from the same point it was last used.
- Tracks selected by operating a connected iPhone/iPod may not be recognized or displayed properly.



Bluetooth AUDIO

The Bluetooth audio system enables users to play music files stored on Bluetooth devices through the vehicle speakers via wireless communication.

This audio system supports Bluetooth, a wireless data system capable of playing portable audio music without cables. If your device does not support Bluetooth, the Bluetooth audio system will not function.

OVERVIEW

The Bluetooth audio operation screen can be accessed by selecting  on the “Media” screen. (→P.129)

Depending on the type of portable player connected, some functions may not be available and/or the screen may look differently than shown in this manual.

► Control panel

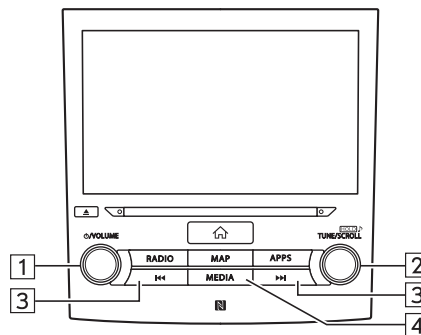

No.	Function
1	Turn to adjust volume. Press to mute the audio system and pause playback. Press and hold to turn the audio system off, and press to turn it on again.
2	Turn to change a track. Press and hold to display the sound settings screen. (→P.78)
3	Press to change a track. Press and hold to fast forward/rewind.
4	Press to switch between media sources.

► Control screen

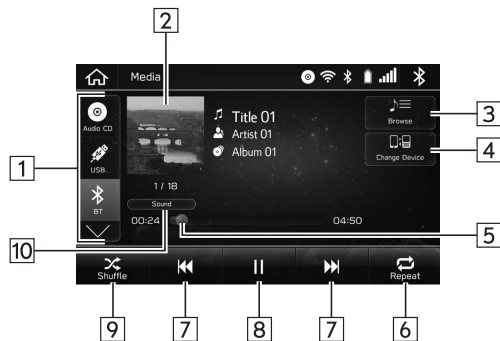

No.	Function
1	Select to switch between other media sources.
2	Displays cover art.
3	Select to display the play mode selection screen. • Select to narrow down the search for tracks in each play mode.
4	Select to display the “Change Device” screen. (→P.159)

No.	Function
5	Shows progress. The playback location can be changed by dragging the sliders.
6	Changes between repeat current track → repeat current folder/album → cancel repeat each time this button is selected.
7	Select to change a track. Select and hold to fast forward/rewind.
8	Select to pause/play.
9	Select to enable/disable random playback for the tracks currently playing on the Bluetooth device.
10	Select to adjust the sound settings. (→P.130)



⚠ WARNING

- Do not operate the player's controls or connect to the Bluetooth audio system while driving.
- This system is fitted with Bluetooth antennas. People with implantable cardiac pacemakers, cardiac resynchronization therapy-pacemakers or implantable cardioverter defibrillators should maintain a reasonable distance between themselves and the Bluetooth antennas. The radio waves may affect the operation of such devices.
- Before using Bluetooth devices, users of any electrical medical device other than implantable cardiac pacemakers, cardiac resynchronization therapy-pacemakers or implantable cardioverter defibrillators should consult the manufacturer of the device for information about its operation under the influence of radio waves. Radio waves could have unexpected effects on the operation of such medical devices.

⚠ CAUTION

- Do not leave your portable player in the vehicle. In particular, high temperatures inside the vehicle may damage the portable player.

NOTE

- Depending on the Bluetooth device that is connected to the system, the music may start playing when selecting  while it is paused. Conversely, the music may pause when selecting  while it is playing.
- In the following conditions, the system may not function:
 - The Bluetooth device is turned off.
 - The Bluetooth device is not connected.
 - The Bluetooth device has a low battery.
- It may take time to connect the phone when Bluetooth audio is being played.
- For operating the portable player, see the instruction manual that comes with it.
- If the Bluetooth device is disconnected due to poor reception from the Bluetooth network when the ignition switch is turned to the "ACC" or "ON" position, the system will automatically reconnect to the portable player.
- If the Bluetooth device is disconnected on purpose, such as it was turned off, this does not happen. Reconnect the portable player manually.
- Bluetooth device information is registered when the Bluetooth device is connected to the Bluetooth audio system. When selling or disposing of the vehicle, remove the Bluetooth audio information from the system. (→P.63)
- Depending on the Bluetooth device or music file being played, the cover art may not be displayed.
- If the Bluetooth device does not play automatically when connected, device operation may be necessary.

CONNECTING A Bluetooth DEVICE

To use the Bluetooth audio system, it is necessary to register a Bluetooth device with the system.

► Registering an additional device

1. Select **Change Device** (Change Device) on the Bluetooth audio control screen.
2. For more information: →P.56

► Selecting a registered device

1. Select **Change Device** (Change Device) on the Bluetooth audio control screen.
2. Select the Bluetooth device to be connected.

AUX

OVERVIEW

The AUX operation screen can be accessed with the following methods:

- Connect a portable audio device. (→P.34)
- Select  on the “Media” screen. (→P.129)

► Control panel

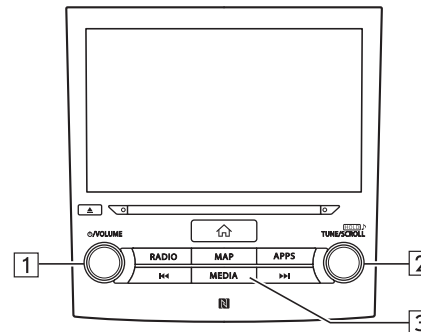

No.	Function
1	Turn to adjust volume. Press to mute the audio system. Press and hold to turn the audio system off, and press to turn it on again.

No.	Function
2	Press and hold to display the sound settings screen. (→P.78)
3	Press to switch between media sources.

► **Control screen**

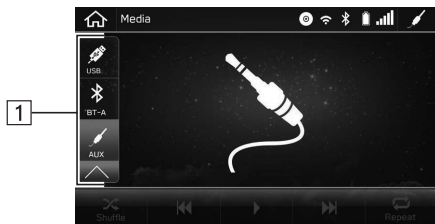

No.	Function
1	Select to switch between other media sources.

! WARNING

- Do not operate the player's controls or connect the portable audio device while driving.

! CAUTION

- Do not leave portable audio device in the vehicle. The temperature inside the vehicle may become high, resulting in damage to the player.
- Do not push down on or apply unnecessary pressure to the portable audio device while it is connected as this may damage the portable audio device or its terminal.
- Do not insert foreign objects into the port as this may damage the portable audio device or its terminal.

AUDIO REMOTE CONTROLS

STEERING WHEEL CONTROLS

Some parts of the audio system can be controlled using the steering wheel controls.

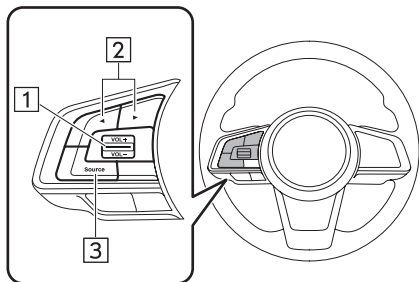

No.	Switch
1	"VOL +/VOL -" switch
2	"</>" switch
3	"Source" switch

▶ "VOL +/VOL -" switch

Mode	Operation	Function
Volume	Press	Volume up/down
	Press and hold	Volume up/down continuously

▶ "</>" switch

Mode	Operation	Function
AM/FM Radio, SiriusXM®	Press	Preset channel up/down
	Press and hold	Scan and stop at the first received station when the switch is released
aha	Press	Content up/down
Audio CD, MP3/WMA/ AAC disc, USB, iPod, Bluetooth audio	Press	Change a track
	Press and hold	Fast forward/rewind
Pandora*	Press	Track up ("▶" only)

*: Pandora is only available in certain countries. Please visit pandora.com/ legal for more information.

▶ “Source” switch

Mode	Operation	Function
All	Press	Change audio modes

NOTE

- In the aha, Pandora* and SUBARU STARLINK mode, some operation may be done on the screen depend on the selected APPS.

*: Pandora is only available in certain countries. Please visit pandora.com/legal for more information.

TIPS FOR OPERATING THE AUDIO SYSTEM

OPERATING INFORMATION

 CAUTION

- To avoid damage to the audio system:
 - Be careful not to spill beverages over the audio system.
 - Do not put anything other than an appropriate disc into the disc slot.

NOTE

- The use of a cellular phone inside or near the vehicle may cause a noise from the speakers of the audio system which you are listening to. However, this does not indicate a malfunction.

RADIO

Usually, a problem with radio reception does not mean there is a problem with the radio — it is just the normal result of conditions outside the vehicle.

For example, nearby buildings and terrain can interfere with FM reception. Power lines or phone wires can interfere with AM signals. And of course, radio signals have a limited range. The farther the vehicle is from a station, the weaker its signal will be. In addition, reception conditions change constantly as the vehicle moves.

Here, some common reception problems that probably do not indicate a problem with the radio are described.

FM

Fading and drifting stations: Generally, the effective range of FM is about 25 miles (40 km). Once outside this range, you may notice fading and drifting, which increase with the distance from the radio transmitter. They are often accompanied by distortion.

Multi-path: FM signals are reflective, making it possible for 2 signals to reach the vehicle's antenna at the same time. If this happens, the signals will cancel each other out, causing a momentary flutter or loss of reception.

Static and fluttering: These occur when signals are blocked by buildings, trees or other large objects. Increasing the bass level may reduce static and fluttering.

Station swapping: If the FM signal being listened to is interrupted or weakened, and there is another strong station nearby on the FM band, the radio may tune in the second station until the original signal can be picked up again.

AM

Fading: AM broadcasts are reflected by the upper atmosphere — especially at night. These reflected signals can interfere with those received directly from the radio station, causing the radio station to sound alternately strong and weak.

Station interference: When a reflected signal and a signal received directly from a radio station are very nearly the same frequency, they can interfere with each other, making it difficult to hear the broadcast.

Static: AM is easily affected by external sources of electrical noise, such as high tension power lines, lightening or electrical motors. This results in static.

SiriusXM®





- Cargo loaded on the roof luggage carrier, especially metal objects, may adversely affect the reception of SiriusXM® Satellite Radio.
- Alternation or modifications carried out without appropriate authorization may invalidate the user's right to operate the equipment.

CD PLAYER AND DISC

- Extremely high temperatures can keep the CD player from working. On hot days, use the air conditioning system to cool the inside of the vehicle before using the player.
- Bumpy roads or other vibrations may make the CD player skip.
- If moisture gets into the CD player, the discs may not be able to be played. Remove the discs from the player and wait until it dries.

⚠ WARNING

- CD players use an invisible laser beam which could cause hazardous radiation exposure if directed outside the unit. Be sure to operate the player correctly.

Audio CDs		
		

- Use only discs marked as shown above. The following products may not be playable on your player:
 - SACD
 - dts CD
 - Copy-protected CD
 - Video CD

► Special shaped discs

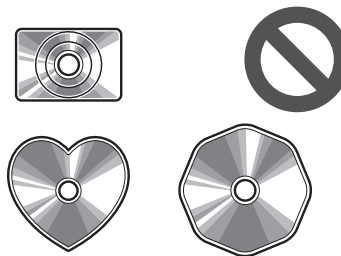

► Transparent/translucent discs

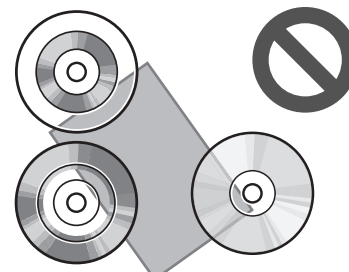

► Low quality discs

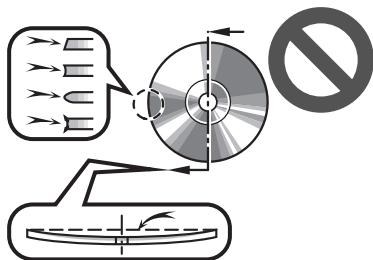

► Labeled discs

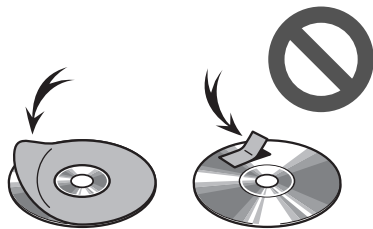

⚠ CAUTION

- Do not use special shaped, transparent/translucent, low quality or labeled discs such as those shown in the illustrations. The use of such discs may damage the player, or it may be impossible to eject the disc.
- This system is not designed for use of Dual Discs. Do not use Dual Discs because they may cause damage to the player.
- Do not use discs with a protection ring. The use of such discs may damage the player, or it may be impossible to eject the disc.
- Do not use printable discs. The use of such discs may damage the player, or it may be impossible to eject the disc.



Correct

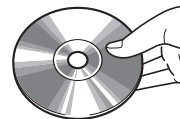

Wrong

- Handle discs carefully, especially when inserting them. Hold them on the edge and do not bend them. Avoid getting fingerprints on them, particularly on the shiny side.

- Dirt, scratches, warping, pin holes or other disc damage could cause the player to skip or to repeat a section of a track. (To see a pin hole, hold the disc up to the light.)
- Remove discs from the players when not in use. Store them in their plastic cases away from moisture, heat and direct sunlight.



To clean a disc: Wipe it with a soft, lint-free cloth that has been dampened with water. Wipe in a straight line from the center to the edge of the disc (not in circles). Dry it with another soft, lint-free cloth. Do not use a conventional record cleaner or anti-static device.

CD-R/RW DISCS

- CD-R/CD-RW discs that have not been subject to the “finalizing process” (a process that allows discs to be played on a conventional CD player) cannot be played.
- It may not be possible to play CD-R/CD-RW discs recorded on a music CD recorder or a personal computer because of disc characteristics, scratches or dirt on the disc, or dirt, condensation, etc. on the lens of the unit.
- It may not be possible to play discs recorded on a personal computer depending on the application settings and the environment. Record with the correct format. (For details, contact the appropriate application manufacturers of the applications.)
- CD-R/CD-RW discs may be damaged by direct exposure to sunlight, high temperatures or other storage conditions. The unit may be unable to play some damaged discs.
- If you insert a CD-RW disc into the player, playback will begin more slowly than with a conventional CD or CD-R disc.
- Recordings on CD-R/CD-RW cannot be played using the DD CD (Double Density CD) system.

USB MEMORY DEVICE

- USB communication formats: USB 2.0 HS (480 Mbps) and FS (12 Mbps)
- File formats: FAT 16/32
- Correspondence class: Mass storage class

iPhone/iPod

The following iPod, iPod nano, iPod touch and iPhone devices can be used with this system.
Made for

- iPhone X
- iPhone 8 Plus
- iPhone 8
- iPhone 7
- iPhone SE
- iPhone 6s Plus
- iPhone 6s
- iPhone 6 Plus
- iPhone 6
- iPhone 5s
- iPhone 5
- iPhone 4s
- iPod touch (5th generation)
- iPod nano (7th generation)

- Depending on differences between models or software versions etc., some models might be incompatible with this system.
- iPod video is not supported.
- For USA customers, please visit www.subaru.com for details. Outside of the USA customers, contact your local dealer to arrange a demonstration in order to confirm whether or not the phone can be paired with the vehicle.

FILE INFORMATION

Codec	Description	Channels	Container/Extension
MPEG-4 AAC LC	8-48 kHz sampling rate 8-320 kbps CBR, VBR	Mono and stereo	.3gp, .m4a, .aac, .mp4
MPEG-4 HE AAC	16-48 kHz sampling rate 8-320 kbps CBR, VBR	Mono and stereo	.3gp, .m4a, .aac, .mp4
MPEG-4 HE AAC v2	16-48 kHz sampling rate 8-320 kbps CBR, VBR	Mono and stereo	.3gp, .m4a, .aac, .mp4
MP3	8-48 kHz sampling rate 8-320 kbps CBR, VBR	Mono, Stereo, and Joint	.mp3
WMA2/7/8/9/9.1/9.2	16-48 kHz sampling rate 8-320 kbps CBR, VBR	Mono and stereo	.wma, .asf

Codec	Description	Channels	Container/ Extension
PCMWAVE	8 bit and 16bit 8000,16000,and 44100Hz sampling frequency	Mono and stereo	.wav

- The player is compatible with VBR (Variable Bit Rate).
- MP3 (MPEG Audio Layer 3), WMA (Windows Media Audio) and AAC (Advanced Audio Coding) are audio compression standards.
- This system can play AAC/AAC+ v2/MP3/WMA files on CD-R, CD-RW discs, USB memory device, and Bluetooth device.
- This system can play disc recordings compatible with ISO 9660 level 1 and level 2 and with the Romeo and Joliet file system.
- When naming an AAC/AAC+ v2/MP3/WMA file, add an appropriate file extension (.mp3/.wma/.m4a).
- This system plays back files with .mp3/.wma/.m4a file extensions as AAC/AAC+ v2/MP3/WMA files respectively. To prevent noise and playback errors, use the appropriate file extension.
- This system can play only the first session when using multi-session compatible CDs.
- MP3 files are compatible with the ID3 Tag Ver. 1.0, Ver. 1.1, Ver. 2.2 and Ver. 2.3 formats. This system cannot display disc title, track title and artist name in other formats.

- WMA/AAC files can contain a WMA/AAC tag that is used in the same way as an ID3 tag. WMA/AAC tags carry information such as track title and artist name.
- This system can play back AAC files encoded by iTunes.
- The sound quality of MP3/WMA files generally improves with higher bit rates. In order to achieve a reasonable level of sound quality, discs recorded with a bit rate of at least 128 kbps are recommended.
- The MP3/WMA player does not play back MP3/WMA files from discs recorded using packet write data transfer (UDF format). Discs should be recorded using “pre-mastering” software rather than packet-write software.
- m3u playlists are not compatible with the audio device.
- MP3i (MP3 interactive) and MP3PRO formats are not compatible with the audio device.
- When playing back files recorded as VBR (Variable Bit Rate) files, the play time will not be correctly displayed if the fast forward or rewind operations are used.
- It is not possible to check folders that do not include AAC/AAC+ v2/MP3/WMA files.

- AAC/AAC+ v2/MP3/WMA files in folders up to 3 levels deep can be played. However, the start of playback may be delayed when using discs containing numerous levels of folders. For this reason, we recommend creating discs with no more than 2 levels of folders.

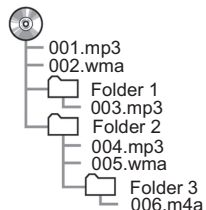

- The play order of the compact disc with the structure shown above is as follows:

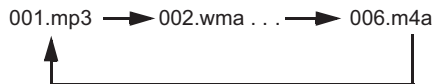

- The order changes depending on the personal computer and AAC/AAC+ v2/MP3/WMA encoding software you use.

Navigation System

(8-inch with Navi system only)



Basic Operation	172
Map Screen	172
Map Screen Overview	172
Map Screen Buttons Overview	173
Map Screen Operation	174
Current Position Display	174
Map Scale	175
Orientation Of The Map	175
Map Screen Information	176
POI Icons	176
Traffic Information	177
Other Information	177
Memory Points	178
Registering Memory Points	178
Editing Memory Points	180
Destination Search	182
Search Operation	182
Setting Home Or Work As The Destination	182
Searching On The Map	183

Searching By Entering A Search Word	183
Searching By POI	184
Searching From Previously Set Destinations	185
Searching From The Favorite Destinations List	186
Searching For Gas Stations	187
Route Calculation	188
Route Calculation Screen	188
Route Guidance	190
Route Guidance	190
Route Guidance Screen	190
Standard Map Icon	192
Typical Voice Guidance Prompts	193
Route Related Functions	193
Checking The Route	193
Editing Route	194
Adding Destinations	194
Checking The Itinerary	195
Reordering Destinations	195
Deleting Destinations	196

Stopping Route Guidance	196
Weather Information	196
Setup	197
Navigation Settings	197
Navigation Settings Screen	197
Tips For The Navigation System	199
GPS (Global Positioning System)	199
Regarding Errors In Current Position Display	199
Limitations Of The Navigation System	199
Map Data	201
Regarding Roads And Place Name Data	201
SUBARU Map Update	201
Updating The Map Data Manually Using A USB Memory Device	202
Updating The Map Data Manually Using Wi-Fi	203
Updating The Map Data Manually Using A Smartphone	204
Updating The Map Data Automatically	208



BASIC OPERATION

MAP SCREEN

MAP SCREEN OVERVIEW

The map screen can be accessed with the following methods:

- Press **MAP**.
- Press **HOME**, and then select **Map** (Map).

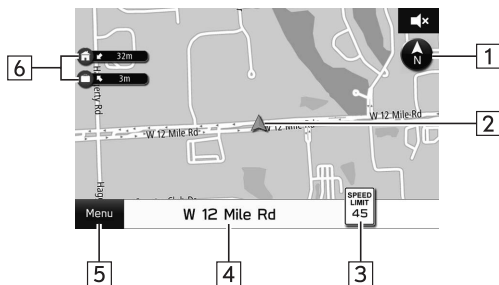

No.	Information/Function	Page
1	Select to change the map display mode between 2D north-up, 2D heading-up, or 3D. In 3D maps, only a heading-up view is available.	175
2	Displays the current vehicle position.	-
3	Displays the speed limit for the road currently being travelled on.	-
4	Displays the current street name. Select to display the current location and geo-coordinates, and register the point as home, work, or favorite.	178
5	Select to display the destination search menu.	183, 184, 185, 186
6	By registering your home or work, (→P.178), the direction and time required are displayed. Select and hold HOME to set home as the destination. Select and hold WORK to set work as the destination.	182

MAP SCREEN BUTTONS OVERVIEW

The map screen buttons can be accessed by selecting any point on the map.

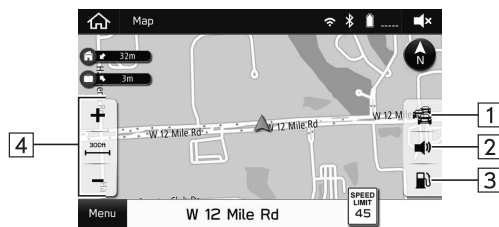

No.	Function	Page
1	Select to turn the traffic information display on/off.	177
2	Select to mute/unmute the voice guidance.	-

No.	Function	Page
3	Select to search for gas stations. When driving on the highway during route guidance, information on gas stations, restaurants, or rest areas near the next three highway exits will be displayed.	187
4	Select to change the map scale.	175

MAP SCREEN OPERATION

CURRENT POSITION DISPLAY

1. Press **MAP**.

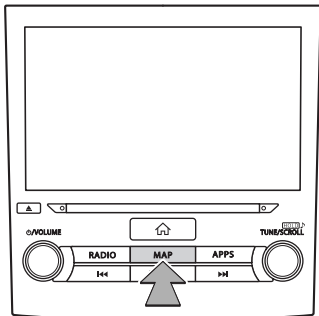

2. Check that the current position map is displayed.



- The current position map can also be displayed by pressing **HOME**, and then selecting **Map** (Map).
- After moving the map, **Resume** (Resume) may be displayed. Select **Resume** (Resume) to return to the previous screen.

NOTE

- While driving, the current position mark is fixed on the screen and the map moves.
- The current position is automatically set as the vehicle receives signals from the GPS (Global Positioning System). If the current position is not correct, it is automatically corrected after the vehicle receives signals from the GPS.
- After the battery disconnection, or on a new vehicle, the current position may not be correct. As soon as the system receives signals from the GPS, the correct current position is displayed.

MAP SCALE

1. Select any point on the map.
2. Select **+** or **-** to change the scale of the map screen.

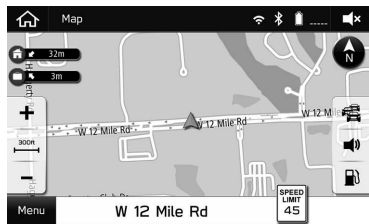



- Select and hold **+** or **-** to continue changing the scale of the map screen.
- When the auto zoom function is ON (→P.197) during route guidance, the map is enlarged automatically when approaching intersections or turning points.

NOTE

- The scale of the map screen can also be changed with the double touch or pinch operation. (→P.34)

ORIENTATION OF THE MAP

The orientation of the map can be changed between 2D north-up, 2D heading-up, and 3D.

1. Select , , or .
 - Each time the symbol is selected, the orientation of the map changes.

▶ 2D north-up

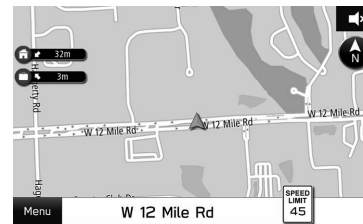

- Regardless of the direction of vehicle travel, north is always up.
- The letter(s) indicate the direction in which the vehicle is heading (e.g. N for north).

▶ 2D heading-up



- The direction of vehicle travel is always up.

▶ 3D heading-up

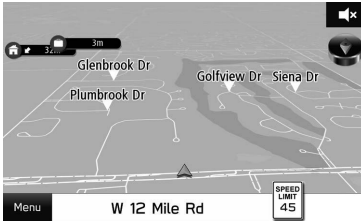

- The direction of vehicle travel is always up.

MAP SCREEN INFORMATION

POI ICONS

Points of Interest such as gas stations and restaurants can be displayed on the map screen. Their location can also be set as a destination.

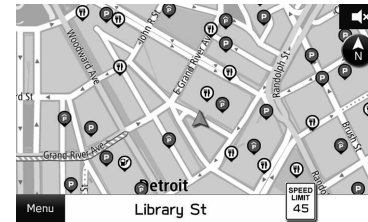

- The display of POI icons can be turned on/off. (→P.197)

TRAFFIC INFORMATION

Road sections affected by traffic conditions are displayed in a different color on the map, and a small icon representing the type of traffic condition is displayed above the road.

To receive the data service information in the vehicle, a subscription to the SiriusXM® Satellite Radio Service is necessary following a free trial. (→P.139)

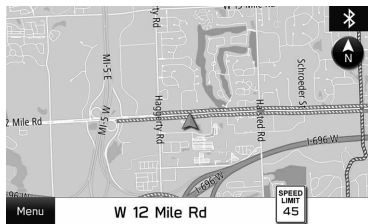

- The display of the traffic information can be turned on/off. (→P.173)

OTHER INFORMATION

A pop-up screen will be displayed based on the driving situation, etc.

► Low fuel warning

When the fuel level is low, a warning message will pop up on the screen.



- **Search** (Search): Select to search for gas stations. (→P.187)
- **Ignore** (Ignore): Select to delete the message.
- Pop-up screens can be turned on/off at “Low Fuel Warning” on the navigation settings screen. (→P.197)

► Periodic rest notification

When you have been driving for a long time, a confirmation message will pop up on the screen.



- **Search** (Search): Select to search for rest areas.
- **Ignore** (Ignore): Select to delete the message.
- Pop-up screens can be turned on/off at the “Rest Stop Guidance Function” on the navigation settings screen. (→P.197)

► Severe weather warning

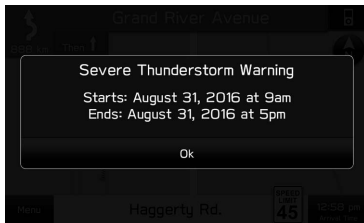

- **OK** (OK): Select to delete the message.

MEMORY POINTS

REGISTERING MEMORY POINTS

The desired point can be registered as home, work, or favorite.

The registered points can be set as a destination.

REGISTERING THE CURRENT POINT

1. Select the current street name.
2. Select **Save** (Save).



3. Select the item for which the street name is to be registered.

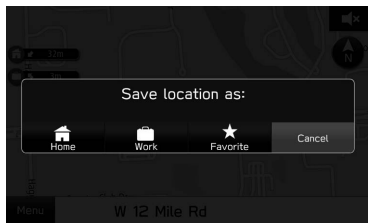

- The point is registered in the favorite destinations list. (→P.186)
- The icons are displayed on the map.

NOTE

- Home and work can also be registered from the navigation settings screen. (→P.197)
- Favorite destinations can also be registered from the route calculation screen. (→P.188)

REGISTERING FROM THE MAP

1. Select and hold the desired point on the map or POI icon.
2. Select ☆.



- ☆ changes to ☆ (yellow), and the point is registered in the favorite destinations list.
- Each time the symbol is selected, the symbol changes between ☆ and ☆ (yellow).

EDITING MEMORY POINTS

1. Select **Menu** (Menu).
2. Select **Nearby Places** (Nearby Places) or **Previous Address** (Previous Address).

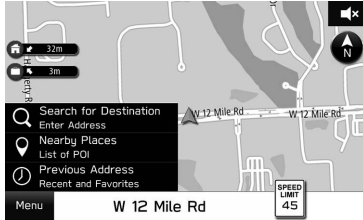

3. Select **Favorite** (Favorite).
4. Select **⚙️**.



- **⚙️**: Select to edit home or work address. (→P.180)
- **🗑️**: Select to delete the item. (→P.180)
- Select the destination to change the name. (→P.181)

EDITING HOME OR WORK ADDRESS

1. Select **⚙️** next to “Home” or “Work”.
2. Enter an address, and then select **Search** (Search).
3. Select the desired item from the list, and then select **Save** (Save).
4. Select **OK** (OK).

NOTE

- Home and work can also be edited from the navigation settings screen. (→P.197)

DELETING FAVORITE DESTINATIONS

1. Select **🗑️** next to the desired item to be deleted.
2. Select **Delete** (Delete).

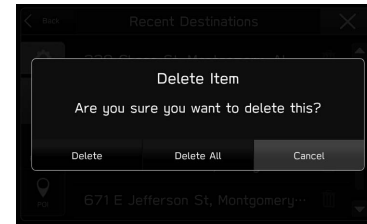

- **Delete All** (Delete All): Select to delete all items.
- **Cancel** (Cancel): Select to cancel deleting.

NOTE

- Favorite can also be deleted from the route calculation screen.
(→P.188)

CHANGING THE FAVORITE DESTINATION NAME

1. Select the desired destination to change the name.
2. Enter a name, and then select **Rename** (Rename).
3. Select **OK** (OK).



DESTINATION SEARCH

SEARCH OPERATION

There are several ways to search for a destination.

Function	Page
Setting home or work as the destination	182
Searching on the map	183
Searching by entering a search word	183
Searching by POI	184
Searching from previously set destinations	185
Searching from the favorite destinations list	186
Searching for gas stations	187
Searching by phonebook	93

SETTING HOME OR WORK AS THE DESTINATION

1. Select and hold  or .



- The estimated travel time and direction to the destination is displayed next to the icon.

2. Check that the route calculation screen is displayed. (→P.188)

NOTE

- To use this function, it is necessary to register the entry. (→P.178)
- Home and work can also be set as the destination from the favorite destinations list. (→P.186)

SEARCHING ON THE MAP

1. Select and hold the desired point on the map or the POI icon.
2. Select **GO** (GO).

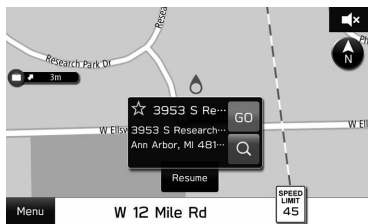

- : Select to search for a destination around the point.
3. Check that the route calculation screen is displayed. (→P.188)

SEARCHING BY ENTERING A SEARCH WORD

The destination can be set by entering a search word, for example an address, a facility name, or latitude/longitude, etc.

1. Select **Menu** (Menu).
2. Select **Search for Destination** (Search for Destination).

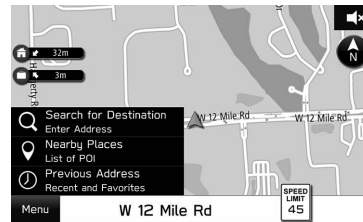

3. Enter the word, and then select **Search** (Search).



No.	Function
1 *	Select to set the radius filter. Once the radius filter has been set, a search will only be performed for items within the radius. Each time the button is selected, the radius filter changes between “Along Route”, “Near Destination”, and “Near Me”.
2	Some candidate destinations are displayed based on the input characters. The route calculation screen is displayed when an item is selected.

*: During route guidance

4. Select the desired item from the list, and then select **GO** (GO).

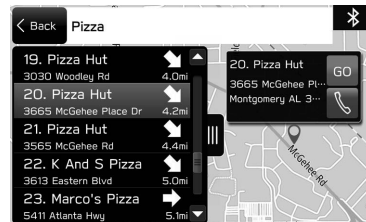

- Select and hold the map to make fine adjustments to the destination.
- : Select to call the registered phone number.
- : Select to open/close the list.

5. Check that the route calculation screen is displayed. (→P.188)

SEARCHING BY POI

1. Select **Menu** (Menu).
2. Select **Nearby Places** (Nearby Places).

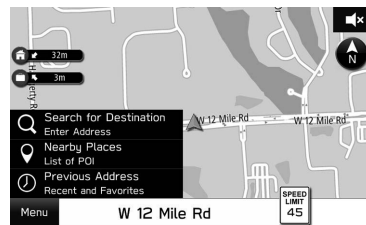



3. Select the desired category.

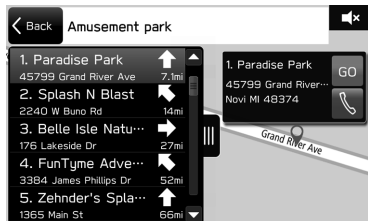

4. Select the desired item from the list, and then select **GO** (GO).



- Select and hold the map to make fine adjustments to the destination.
 - : Select to call the registered phone number.
 - : Select to open/close the list.
5. Check that the route calculation screen is displayed. (→P.188)

SEARCHING FROM PREVIOUSLY SET DESTINATIONS

1. Select **Menu** (Menu).
2. Select **Previous Address** (Previous Address).

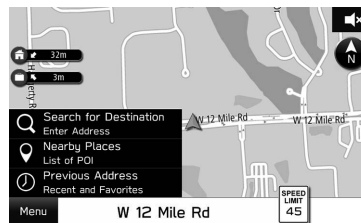



3. Select the desired item.



4. Check that the route calculation screen is displayed. (→P.188)

DELETING THE ITEM IN THE LIST

1. Select  on the “Recent Destinations” screen.
2. Select  next to the desired item to be deleted.



3. Select **Delete** (Delete).

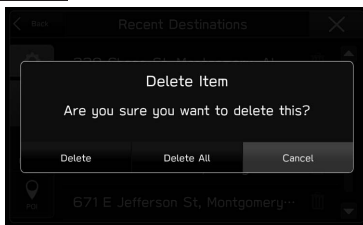

- **Delete All** (Delete All): Select to delete all items.
- **Cancel** (Cancel): Select to cancel deleting.

SEARCHING FROM THE FAVORITE DESTINATIONS LIST

1. Select **Menu** (Menu).
2. Select **Nearby Places** (Nearby Places) or **Previous Address** (Previous Address).

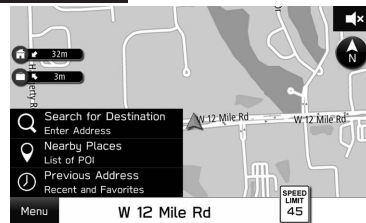

3. Select **Favorite** (Favorite).
4. Select the desired item.

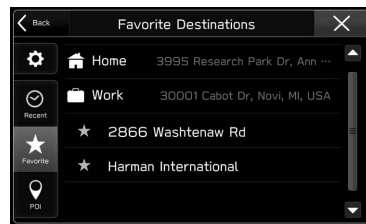

5. Check that the route calculation screen is displayed. (→P.188)

NOTE

- To use this function, it is necessary to register the entry. (→P.178)

SEARCHING FOR GAS STATIONS

1. Select any point on the map.
2. Select .

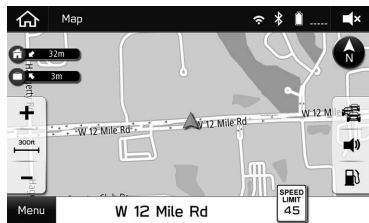

- When driving on the highway during route guidance, information on gas stations, restaurants, or rest areas near the next three highway exits will be displayed.

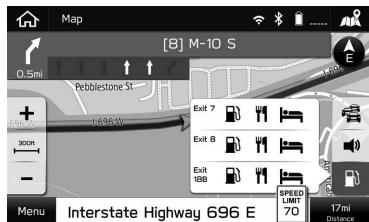

3. Select the desired item from the list, and then select **GO** (GO).

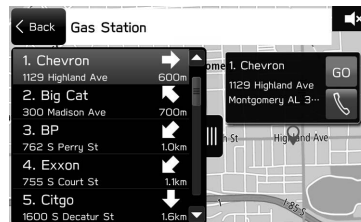

- : Select to call the registered phone number.
4. Check that the route calculation screen is displayed. (→P.188)

ROUTE CALCULATION

ROUTE CALCULATION SCREEN

After searching for the destination, the route calculation screen will be displayed.

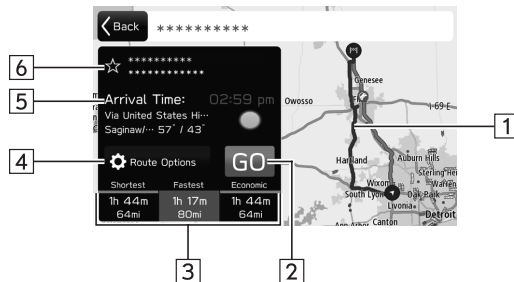

No.	Information/Function
1	Displays the route overview.
2	Select to start route guidance.

No.	Information/Function
3	Select one of the three recommended routes. The route type (→P.197) set in Route Settings is displayed in blue.
4	Select to set the avoidance criteria for the current route. (→P.189)
5	Displays the arrival time. If SiriusXM Travel Link is available, the weather icon name, name of the weather station closest to the destination, and the High/Low temperature for that location will be displayed. For details on SiriusXM Travel Link: →P.123
6	Select to register the point in the favorite destinations list. (→P.186)

WARNING

- Be sure to obey traffic regulations and keep road conditions in mind while driving. If a traffic sign on the road has been changed, the route guidance may not indicate such changed information.

NOTE

- The route for returning may not be the same as that for going.
- The route guidance to the destination may not be the shortest route or a route without traffic congestion.
- Route guidance may not be available if there is no road data for the specified location.

NOTE

- If a destination that is not located on a road is set, the vehicle will be guided to the point on a road nearest to the destination. The road nearest to the selected point is set as the destination.

ROUTE SETTINGS SCREEN

The avoidance criteria for the route calculation can be set.

1. Select **Route Options** (Route Options) on the route calculation screen.
2. Select the desired item.



NOTE

- The avoidance criteria for the route calculation can also be set from the navigation settings screen. (→P.197)

ROUTE GUIDANCE

ROUTE GUIDANCE

ROUTE GUIDANCE SCREEN

During route guidance, various types of guidance screens can be displayed depending on conditions.

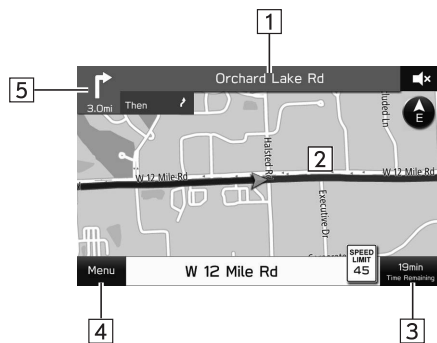

No.	Information/Function
1	Displays the next street name. Select to display the turn/itinerary list. (→P.193, 195)
2	Displays the guidance route.
3	Displays the distance, the estimated travel time to the destination, or the estimated arrival time at the destination. Select the information box, and then select the desired information.
4	Select to search for a destination or stop route guidance. (→P.196)
5	Displays the distance to the next turn with an arrow indicating the turn direction. Select to play the navigation announcement.

► Junction screen

When approaching an expressway exit or a complicated intersection, the map switches to a 3D display if the necessary information can be displayed. An arrow indicates the lane in which you should drive. Signs are also displayed if the information is available.

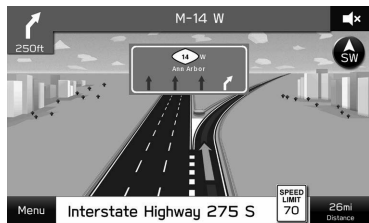

► Lane recommendation screen

When approaching a turning point, the lane recommendation will be displayed automatically.



“Then” will be displayed if necessary to turn again immediately after a turn.



► Auto zoom screen











When the auto zoom function is ON (→P.197), the map is enlarged automatically when approaching intersections or turning points.





NOTE

- If the vehicle goes off the guidance route, the route is searched again.
- For some areas, the roads have not been completely digitized in our database. For this reason, the route guidance may select a road that should not be traveled on.

STANDARD MAP ICON

The following table shows the most frequently displayed route events.

Icon	Explanation
	Turn left
	Turn right
	U-turn left
	U-turn right
	Keep left at the fork in the road.
	Keep right at the fork in the road.
	Turn left & sharp curve.
	Turn right & sharp curve.
	Stay in the left lane.
	Stay in the right lane.
	Go straight ahead at the intersection.

Icon	Explanation
	Turn left at the T junction.
	Turn right at the T junction.
	Go left at the roundabout.
 (blue)	You are half way to your destination.
 (checkered)	You have arrived at your destination.

TYPICAL VOICE GUIDANCE PROMPTS

As the vehicle approaches an intersection, or point, where maneuvering the vehicle is necessary, the system's voice guidance will provide various messages.

⚠ WARNING

- Be sure to obey the traffic regulations and keep the road condition in mind especially when you are driving on IPD roads. The route guidance may not have the updated information such as the direction of a one way street.

NOTE



- Turn the “**VOLUME**” knob, or use the volume control switch on the steering wheel to adjust the voice guidance volume.
- The voice guidance volume can also be adjust from the sound settings screen. (→P.78)
- Voice guidance may be made early or late.
- If the system cannot determine the current position correctly, you may not hear voice guidance or may not see the magnified intersection on the screen.

ROUTE RELATED FUNCTIONS

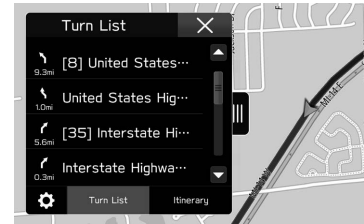

CHECKING THE ROUTE

1. Select the next street name. (→P.190)
2. Select **Turn List** (Turn List).
3. Select the item for which the route is to be checked.



- Select the  displayed when the map is moved to display a screen showing all routes.
- : Select to close the list and display the screen showing all routes.

EDITING ROUTE

1. Select the next street name. (→P.190)
2. Select **Turn List** (Turn List).
3. Select .
4. Select  next to the desired item to be deleted.



- The route will be recalculated automatically.

ADDING DESTINATIONS

1. Search for an additional destination in the same way as a destination search. (→P.182)
2. Select **Add Waypoint** (Add Waypoint).

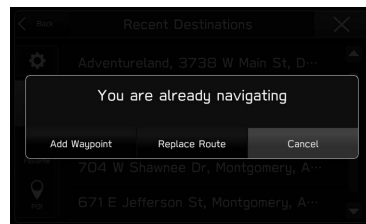

- **Replace Route** (Replace Route): Select to replace the existing destination with a new one.
- **Cancel** (Cancel): Select to cancel adding destinations.
- The route will be recalculated automatically.



NOTE

- The last entered destination is added as the first destination. The destination order can be changed. (→P.195)

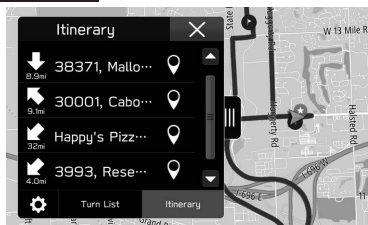

CHECKING THE ITINERARY

1. Select the next street name. (→P.190)
2. Select **Itinerary** (Itinerary).



- Select the  displayed when the map is moved to display a screen showing all routes.
- : Select to close the list and display the screen showing all routes.

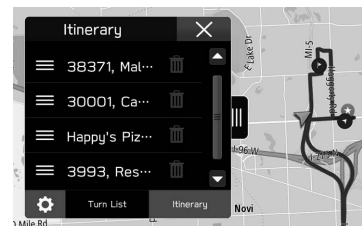

REORDERING DESTINATIONS

1. Select the next street name. (→P.190)
2. Select **Itinerary** (Itinerary).
3. Select .
4. Select  next to the desired destination, and then drag it to the desired position.



- The route will be recalculated automatically.

DELETING DESTINATIONS

1. Select the next street name. (→P.190)
2. Select **Itinerary** (Itinerary).
3. Select .
4. Select  next to the desired item to be deleted.
 - The route will be recalculated automatically.

STOPPING ROUTE GUIDANCE

1. Select **Menu** (Menu).
2. Select **Cancel** (Cancel).



WEATHER INFORMATION

“At Destination” and “Along Route” weather information can be checked during route guidance using the SiriusXM Travel Link function.

For details on SiriusXM Travel Link: →P.123

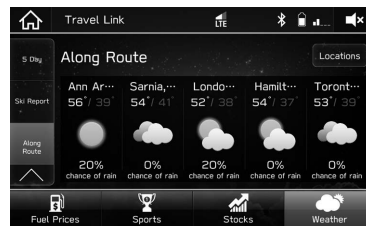

SETUP

NAVIGATION SETTINGS

1. Press .

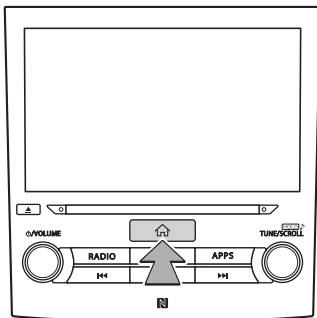

2. Select **Settings** (Settings).
 3. Select **Navigation** (Navigation).
 4. Select the desired item to be set.

NAVIGATION SETTINGS SCREEN

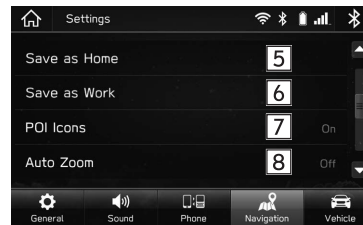
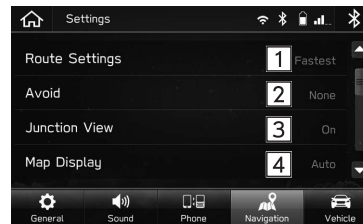

No.	Function
1	Select to set the route type.
2	Select to set avoidance criteria for the route calculation.
3	Select to turn the display for the junction view on/off.
4	Select to set the screen mode. "Auto": Select to change the screen to day or night mode depending on the position of the headlight switch. "Day": Select to always display the map in day mode. "Night": Select to always display the map in night mode.
5	Select to register or edit the home address. • When home has been registered, Change Home (Change Home) is displayed. • For details on registering or editing the address: →P.180
6	Select to register or edit the work address. • When work has been registered, Change Work (Change Work) is displayed. • For details on registering or editing the address: →P.180
7	Select to turn the display for POI icons on/off.
8	Select to set whether to automatically enlarge the map when approaching intersections or turning points during route guidance.
9	Select to set the updating of map data. (→P.201)

No.	Function
10	Select to display the request code for downloading the maps via the website.
11	Select to turn the display for the periodic rest notification pop-up screen on/off.
12	Select to turn the display for the low fuel warning pop-up screen on/off.

TIPS FOR THE NAVIGATION SYSTEM

GPS (GLOBAL POSITIONING SYSTEM)

REGARDING ERRORS IN CURRENT POSITION DISPLAY

The system displays the vehicle current position based on GPS information and data from various sensors and road maps. However, when the radiowave signals from GPS satellites are weak or when signals are received from only two satellites or less, errors may occur in the position. Modifying or adjusting the system will not prevent these errors.

LIMITATIONS OF THE NAVIGATION SYSTEM

This navigation system calculates the current position using satellite signals, various vehicle signals, map data, etc. However, an accurate position may not be shown depending on satellite conditions, road configuration, vehicle condition or other circumstances.

The Global Positioning System (GPS) developed and operated by the U.S. Department of Defense provides an accurate current position, normally using 4 or more satellites, and in some case 3 satellites. The GPS system has a certain level of inaccuracy. While the navigation system compensates for this most of the time, occasional positioning errors of up to 300 feet (100 m) can and should be expected. Generally, position errors will be corrected within a few seconds.

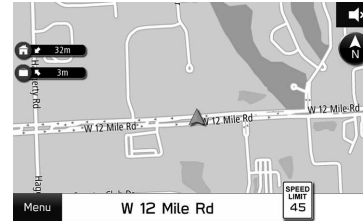

The GPS signal may be physically obstructed, leading to inaccurate vehicle position on the map screen. Tunnels, tall buildings, trucks, or even the placement of objects on the instrument panel may obstruct the GPS signals.

The GPS satellites may not send signals due to repairs or improvements being made to them.

Even when the navigation system is receiving clear GPS signals, the vehicle position may not be shown accurately or inappropriate route guidance may occur in some cases.

 **CAUTION**

- The installation of window tinting may obstruct the GPS signals. Most window tinting contains some metallic content that will interfere with GPS signal reception of the antenna in the instrument panel. We advise against the use of window tinting on vehicles equipped with navigation systems.
- Accurate current position may not be shown in the following cases:
 - When driving on a small angled Y-shaped road.
 - When driving on a winding road.
 - When driving on a slippery road such as in sand, gravel, snow, etc.
 - When driving on a long straight road.
 - When freeway and surface streets run in parallel.
 - After moving by ferry or vehicle carrier.
 - When a long route is searched during high speed driving.
 - After repeating a change of direction by going forward and backward, or turning on a turntable in a parking lot.
 - When leaving a covered parking lot or parking garage.
 - When a roof carrier is installed.
 - When driving with tire chains installed.
 - When the tires are worn.
 - After replacing a tire or tires.
- When using tires that are smaller or larger than the factory specifications.
- When the tire pressure in any of the 4 tires is not correct.
- Inappropriate route guidance may occur in the following cases:
 - When turning at an intersection off the designated route guidance.
 - If you set more than 1 destination but skip any of them, auto reroute will display a route returning to the destination on the previous route.
 - When turning at an intersection for which there is no route guidance.
 - When passing through an intersection for which there is no route guidance.
 - During auto reroute, the route guidance may not be available for the next turn to the right or left.
 - During high speed driving, it may take a long time for auto reroute to operate. In auto reroute, a detour route may be shown.
 - After auto reroute, the route may not be changed.
 - If an unnecessary U-turn is shown or announced.
 - If a location has multiple names and the system announces 1 or more of them.
 - When a route cannot be searched.
 - If the route to your destination includes gravel, unpaved roads or alleys, the route guidance may not be shown.

- Your destination point might be shown on the opposite side of the street.
- When a portion of the route has regulations prohibiting the entry of the vehicle that vary by time or season or other reasons.
- The road and map data stored in the navigation system may not be complete or may not be the latest version.

NOTE

- This navigation system uses tire turning data and is designed to work with factory-specified tires for the vehicle. Installing tires that are larger or smaller than the originally equipped diameter may cause inaccurate display of the current position. The tire pressure also affects the diameter of the tires, so make sure that the tire pressure of all 4 tires is correct.

MAP DATA

REGARDING ROADS AND PLACE NAME DATA

When maps are created, land surveys are conducted and information on road improvements and reopening is collected to provide the most accurate information possible. However, modifications to roads, place names and facilities may be carried out at any time. Consequently, we cannot guarantee that map data contains no errors in road positions, configuration and names, or in facility names.

SUBARU MAP UPDATE

Map data can be updated using the following methods:

- USB memory: All map data can be updated at once. (→P.202)
- Wi-Fi: The map data for up to 8 regions can be selected and updated. (→P.203)
- Smartphone: The map data for up to 8 regions can be selected and updated. This method is for when the map update data is to be downloaded to a smartphone from outside of the vehicle, such as at home, and then transferred to the system. (→P.204)

NOTE

- Map update using Wi-Fi or a smartphone may not be available in some countries.
- When map update data is being installed, a blank map screen will be displayed for the region that is being updated. If the vehicle is operated while the map data is being updated, the map function may not be available until the update procedure is complete.
- For the best possible navigation experience, regularly update maps for all frequented regions, including nearby states. Failure to update maps for surrounding states may result in inaccurate map information during interstate travel. Updates made using a USB memory device will update map information for all states. Please visit Subaru.com for more information and the latest updates.
- If the map update fails or cannot be performed when using Wi-Fi or a connected smartphone, check the communication status of the connected device. If there is a problem with communication, perform the procedure again using a different Wi-Fi access point or smartphone.
- If the map update procedure fails, refer to the “WHAT TO DO IF” section. (→P.241)
- SUBARU, in its sole discretion, may terminate or suspend your access to all or part of the Services for any or no reason, including without limitation, any violation of these Terms.

UPDATING THE MAP DATA MANUALLY USING A USB MEMORY DEVICE

Maps can be updated using a USB memory device.

For details and to download update data, refer to the following URL:

<https://subaru-maps.com/>

UPDATING THE MAP DATA MANUALLY USING WI-FI

The map data may also be updated via Wi-Fi network.

1. Connect to a Wi-Fi network. (→P.69)
2. Select **Map Update** (Map Update) on the navigation settings screen. (→P.197)
3. Select **Select Region (Max up to 8)** (Select Region (Max up to 8)).

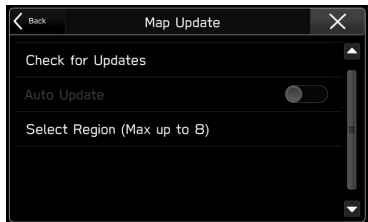

4. Select the regions for which maps are to be updated.

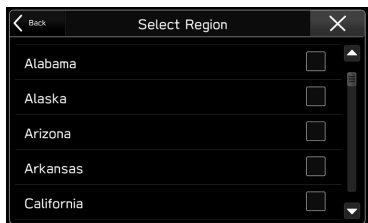

5. Select **Back** (Back) or **X**.

6. Select **Check for Updates** (Check for Updates).



7. Check the confirmation message, and then select **Yes** (Yes).

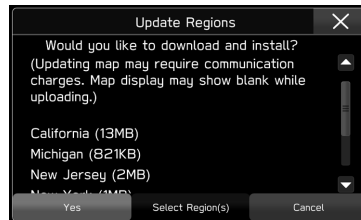

- **Select Region(s)** (Select Region(s)): Return to "STEP 4" and select the region again.
- **Cancel** (Cancel): Select to cancel updating the map data.

8. The following screen is displayed simultaneously with the start of download and installation.

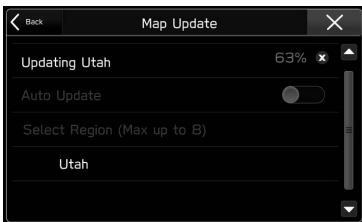

- **X**: Select to cancel the update download and installation. If the download has completed, only installation can be canceled.

If **Cancel Download** (Cancel Download) is selected, the download to the smartphone can later be resumed.

NOTE

- If the Wi-Fi connection is cut while downloading, a blank map screen may be displayed. In this case, reconnect and perform the download and installation procedure again to restore the system.

UPDATING THE MAP DATA MANUALLY USING A SMARTPHONE

If the system cannot connect to a Wi-Fi network, the map data can be updated using a smartphone. Map update data can be downloaded to a smartphone from outside of the vehicle, such as at home, and then transferred to the system to perform the map data update.

When updating the map data using a smartphone, the SUBARU STARLINK application must be installed on the smartphone.

NOTE

- Map update data for each region can be downloaded if it is 30 MB or less.

DOWNLOAD MAP UPDATE DATA TO A SMARTPHONE

1. Connect a smartphone to the system via Bluetooth.
 - When using an iPhone, it can also be connected using a USB cable.
2. Start the SUBARU STARLINK application on the smartphone.
3. Select **Map Update** (Map Update) on the navigation settings screen. (→P.197)
4. Select **Select Region (Max up to 8)** (Select Region (Max up to 8)).

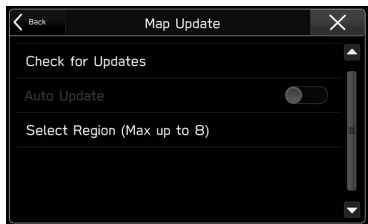

- If **Select Region (Max up to 8)** (Select Region (Max up to 8)) cannot be selected, perform this procedure again from “STEP 1”.

5. Select the regions for which maps are to be updated.

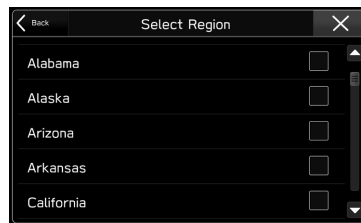

6. Select **Back** (Back) or **X**.
7. Change the mobile data communication setting of the SUBARU STARLINK application on the smartphone to on.
8. Select **Check for Updates** (Check for Updates) on the map update screen.

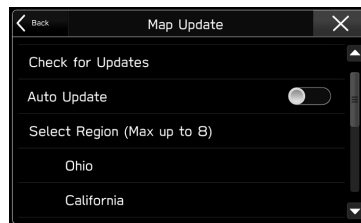

9. Select **Cancel** (Cancel).
10. Connect the smartphone to a Wi-Fi network.
11. Using the SUBARU STARLINK application on the smartphone, download the map update data.

INSTALL MAP UPDATE DATA

1. Connect a smartphone to the system via Bluetooth.
 - When using an iPhone, it can also be connected using a USB cable.
2. Select **Map Update** (Map Update) on the navigation settings screen. (→P.197)
3. Select **Check for Updates** (Check for Updates) on the map update screen.

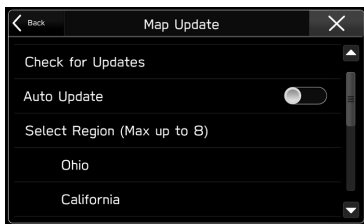

- If “Auto Update” is enabled, the map update data will be installed automatically when the smartphone is connected to the system.

4. Check the confirmation message, and then select **Yes** (Yes).

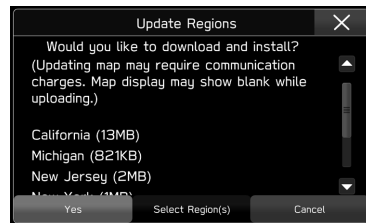

- **Select Region(s)** (Select Region(s)): Return to “STEP 5” in “DOWNLOAD MAP UPDATE DATA TO A SMARTPHONE” and select the desired regions again. (→P.205)
- **Cancel** (Cancel): Select to cancel updating the map data.
- If the mobile data communication setting has not been turned on on the SUBARU STARLINK application, the map update data cannot be downloaded.

5. The following screen is displayed simultaneously with the start of download and installation.

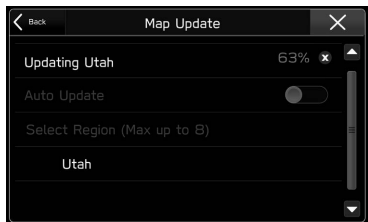

- **X**: Select to cancel the update download and installation. If the download has completed, only installation can be canceled. If **Cancel Download** (Cancel Download) is selected, the download to the smartphone can later be resumed.
- Even if installation is cancelled, the map data downloaded to the smartphone will not be deleted. Therefore, installation can be performed immediately the next time the update procedure is started.

NOTE

- When downloading map data using the SUBARU STARLINK application, make sure there is sufficient storage space on the smartphone for the selected region map data.
- When using an iPhone to perform an update, connecting the iPhone to the system via USB is recommended. In this case, if a genuine Apple USB cable is used, high speed communication is possible.
- While the map update data is being installed, even if another screen is displayed, the update will continue to be installed.
- This product uses the smartphone's data plan for features and services.
Please consult carrier data plan usage, pricing, data overage charges, limitations and usage guidelines.

ABOUT THE SUPPORTED DEVICES

This system supports the following devices.

- iPhone: iOS 11 or later
- Android: Android 7.0 or later

UPDATING THE MAP DATA AUTOMATICALLY

1. Follow “STEPS 1 to 5” in “UPDATING THE MAP DATA MANUALLY USING Wi-Fi”. (→P.203)
2. Set “Auto Update” to on.



3. Check the confirmation message, and then select **I Agree** (I Agree).

8

Siri/Voice Recognition System



Siri	210
Siri	210
Before Using Siri	210
Using Siri	210
Siri Operation	211
Voice Recognition System Operation	213
Voice Recognition System	213
Using The Voice Recognition System	213
Voice Recognition System Operation	214
Command List	215

Siri

Siri is a function that allows your iPhone and iPod touch to be used without any manual operation by connecting your device to the unit.

To use Siri, connect your device via Bluetooth.

BEFORE USING Siri

This section describes the preparation required to use Siri.

- Register your iPhone or iPod touch in the unit. (→P.52)
- Connect your iPhone or iPod touch to the unit. (→P.58)
- Enable Siri in your iPhone or iPod touch settings. (See Apple website for details.)
- An iPhone and iPod touch data plan: If the data plan for your iPhone and iPod touch does not provide for unlimited data usage, additional charges from your carrier may apply for accessing app-based connected content via 3G, 4G, Wi-Fi, or 4G LTE wireless networks.
- Connection to the internet via 3G, 4G, Wi-Fi, or 4G LTE networks.

NOTE

- Available operations will differ based on your iPhone and iPod touch.
- Be careful not to exceed the data usage limits for your iPhone and iPod touch. Doing so will result in additional data usage charges from your phone carrier.

USING Siri

STEERING SWITCH

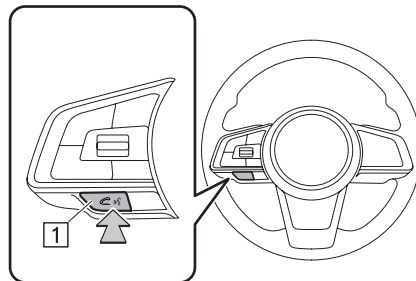

1 Talk switch

- Press and hold the talk switch to start Siri.
- To cancel Siri, press the talk switch.

MICROPHONE

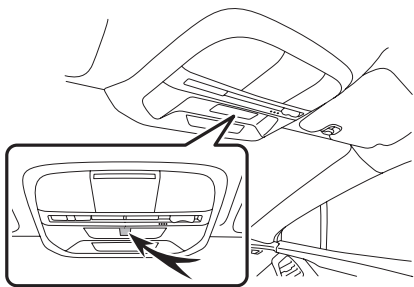

- It is unnecessary to speak directly into the microphone when using Siri.

Siri OPERATION

1. Press and hold the talk switch.
2. Speak when you hear the beep sound.
 - If required to say more, the system will notify you with the beep sound. Continue speaking.
 - If the system fails to recognize what is being said, or to request a different operation, press and hold the talk switch.
 - To cancel Siri, press the talk switch.

NOTE

- Siri cannot be started while placing or receiving hands-free calls with your iPhone and iPod touch (including while holding incoming calls), or while having a hands-free conversation.
- Siri cannot be used while using the system's voice recognition function. Start Siri after exiting the voice recognition function.
- The system screen will display the calling screen when a hands-free call is placed.
- Unit operation while using Siri will differ depending on your iPhone or iPod touch.
- Siri may not recognize what is being said if:
 - Spoken too quickly.
 - Spoken at a low or high volume.
 - Driving with a window open.
 - Passengers are talking while using Siri.
 - The air conditioning speed is set high.
 - When air from the ventilator blows directly toward the microphone.
- In the following conditions, the system may not recognize what is being said properly, and use of Siri may not be possible.
 - What is being said is incorrect or unclear. Note that certain words, accents or speech patterns may be difficult for your iPhone or iPod touch to recognize.
 - There is excessive background noise, such as wind noise.
- Functionality offered by Siri is dependent on the iOS version, and as such, specifications may be subject to change without prior notice.

ABOUT THE SUPPORTED DEVICES FOR Siri

This system supports the following devices.

■ Supported iOS versions

- iOS 6 or later

■ Supported models

- iPhone X
- iPhone 8 Plus
- iPhone 8
- iPhone 7
- iPhone SE
- iPhone 6s Plus
- iPhone 6s
- iPhone 6 Plus
- iPhone 6
- iPhone 5s
- iPhone 5
- iPhone 4s
- iPod touch (5th generation)

VOICE RECOGNITION SYSTEM OPERATION

VOICE RECOGNITION SYSTEM

The voice recognition system enables the navigation, audio, hands-free systems, etc. to be operated using voice commands.

Refer to the command list for samples of voice commands.
(→P.215)

USING THE VOICE RECOGNITION SYSTEM

STEERING SWITCH

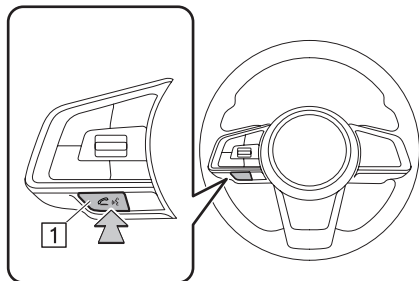

1 Talk switch

- Press the talk switch to start the voice recognition system.
- To cancel voice recognition, press and hold the talk switch or the source switch.

MICROPHONE

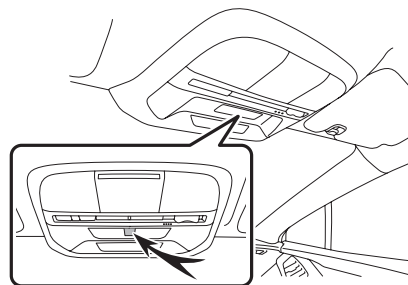

- It is unnecessary to speak directly into the microphone when giving a command.

NOTE

- This function or part of this function may not be available in some languages and countries.
- Wait for the confirmation beep before speaking a command.

NOTE

- Voice commands may not be recognized if:
 - Spoken too quickly.
 - Spoken at a low or high volume.
 - Driving with a window open.
 - Passengers are talking while voice commands are spoken.
 - The air conditioning speed is set high.
 - When air from the ventilator blows directly toward the microphone.
- In the following conditions, the system may not recognize the command properly and using voice commands may not be possible:
 - The command is incorrect or unclear. Note that certain words, accents or speech patterns may be difficult for the system to recognize.
 - There is excessive background noise, such as wind noise.

VOICE RECOGNITION SYSTEM OPERATION**1.** Press the talk switch.

- After the voice recognition top screen has been displayed, speech guidance will commence.

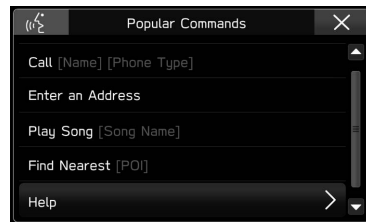
2. Say the command.

- When selecting **Help** (Help) or saying **“Help”**, all commands supported by the system are listed.
- To cancel voice recognition, select **X**, or press and hold the talk switch.

NOTE

- Turn the “**VOLUME**” knob, or use the volume control switch on the steering wheel to adjust the speech guidance volume.
- The system’s voice recognition function cannot be used while using Siri, Apple CarPlay or Android Auto. Start the voice recognition function after exiting Siri, Apple CarPlay or Android Auto.

COMMAND LIST

Recognizable voice commands and their actions are shown below.

- Frequently used commands are listed in the following tables.
- For devices that are not installed in the vehicle, the related commands will not be displayed in the screen. Also, according to conditions, other commands may not be displayed in the screen.
- The functions available may vary according to the system installed.
- Voice recognition language can be changed. (→P.63)

NOTE

- The notations used in the commands are as follows.
 - [○○○]: Numbers, titles, or names to be spoken
 - (○○○): Choose one of the command from within the brackets

► Main commands

Voice command	Function
Enter an Address* ¹	Enables setting a destination by saying the address
Navigate to [House Number, Street, City, State]* ¹	Enables setting a destination by saying the address with city and state
Find Nearest [POI]* ¹	Displays a list of POI category near the current position
Call [Name] [Phone Type]	Place a call to the spoken contact name and phone type of the contact from the phonebook
Dial [Number]	Places a call to the spoken phone number
Play Song [Song Name]	Plays the selected song
Show (Songs / Albums / Artists / Genres / Playlists / Podcasts / Composers / Audiobooks)	Displays the list of Songs/Albums/Artists/Genres/Playlists/Podcasts/Composers/Audiobooks
Tune to [Frequency] (AM / FM)	Switches to AM/FM and tunes to spoken frequency
Preset [Number]	Switches to the preset channel

Voice command	Function
Set Fan Speed to [1-7]	Sets the fan speed to the spoken fan speed
Set Temperature to [Number]* ²	Sets the temperature to the spoken temperature
Change Source to (AM / FM / USB / iPod / Bluetooth / CD / Auxiliary / Satellite Radio)	Changes source to AM/FM/USB/iPod/Bluetooth/CD/Auxiliary/SiriusXM® Satellite Radio
Go to (Radio / Media / Phone / Map* ¹ / Home / Settings / Pandora / Aha / Apps)	Changes screen to Radio/Media/Phone/Map* ¹ /Home/Settings/Pandora/Aha/Apps
Help	Changes to help screen

*¹: 8-inch with Navi system only

*²: When the AC is off, the AC settings will not change even if changes are requested by voice command and the command is accepted.

► Navigation commands*

*: 8-inch with Navi system only

Voice command	Function
Enter an Address	Enables setting a destination by saying the address
Navigate to [House Number, Street, City, State]	Enables setting a destination by saying the address with city and state
Drive Home	Displays the route to home
Drive to Work	Displays the route to work
Find Nearest [POI]	Displays a list of POI category near the current position
Find Gas Station	Displays the list of gas station near the current position
Show Map	Displays the map screen
Stop Route	Cancels route guidance
Where am I	Displays current location on map
Navigation Help	Displays a list of voice commands related to navigation

► Phone commands

Voice command	Function
Send a Text Message to [Name] [Phone Type]	Send the preset message to the spoken contact name and phone type of the contact from the phonebook
Call [Name] [Phone Type]	Place a call to the spoken contact name and phone type of the contact from the phonebook
Dial [Number]	Places a call to the spoken phone number
Redial	Places a call to the phone number of the latest outgoing call
Paired Phones	Displays the phone settings screen
Recent Calls	Displays the call history screen
Missed Calls	Displays the missed call list screen
Reply to Text Message	Reply to text message
View Text Messages	Displays the message inbox screen
Phone help	Displays a list of voice commands related to controlling your phone

► Media commands

Voice command	Function
Track [Number]	Plays the selected track
Play Song [Song Name]	Plays the selected song
Play Album [Album Name]	Plays tracks from the selected album
Play Artist [Artist Name]	Plays tracks from the selected artist
Play Genre [Genre Name]	Plays tracks from the selected genre
Play Playlist [Playlist Name]	Plays tracks from the selected playlist
Play Podcast [Podcast Name]	Plays the selected podcast
Play Audiobook [Book Name]	Plays the selected audiobook
Play Composer [Composer Name]	Plays tracks from the selected composer
Show (Songs / Albums / Artists / Genres / Playlists / Podcasts / Composers / Audiobooks)	Displays the list of Songs/Albums/Artists/Genres/Playlists/Podcasts/Composers/Audiobooks

Voice command	Function
Shuffle (On/Off)	Turns shuffle on/off
Browse Album [Album Name]	Displays the list of songs of the album
Browse Artist [Artist Name]	Displays the list of albums of the artist
Browse Genre [Genre Name]	Displays the list of artists of genre
Browse Playlist [Playlist Name]	Displays the list of playlist
Browse Composer [Composer Name]	Displays the list of albums from the composer
Media Help	Displays a list of commands related to the media

NOTE

- Depending on the device, your iPhone/iPod may not work when operated via voice recognition.

► Radio commands

Voice command	Function
Tune to [Frequency] (AM / FM)	Switches to AM/FM and tunes to the spoken frequency
Preset [Number]	Switches to the preset channel
Satellite Channel [Name / Channel Number]	Switches to satellite channel number
Satellite Category [Category Name]	Displays the list of Satellite Channels of the spoken category
Radio Help	Displays a list of commands related to the radio

► **Climate commands**

Voice command	Function
Auto AC On	Switches on the Auto AC mode on
Set Fan Speed to [1-7]	Sets the fan speed to the spoken fan speed
Set Driver Temperature to [Number]*	Sets the driver temperate to the spoken temperature
Set Passenger Temperature to [Number]*	Sets the passenger temperature to the spoken temperature
Set Temperature to [Number]*	Sets the temperature to the spoken temperature
Set Both Temperatures to [Number]*	Sets the both temperature to the spoken temperature

*: When the AC is off, the AC settings will not change even if changes are requested by voice command and the command is accepted.

► **More commands**

Voice command	Function
Change Source to (AM / FM / USB / iPod / Bluetooth / CD / Auxiliary / Satellite Radio)	Changes source to AM/FM/USB/iPod/Bluetooth/CD/Auxiliary/SiriusXM® Satellite Radio
Go to (Radio / Media / Phone / Map* ¹ / Home / Settings / Pandora / Aha / Apps)	Changes screen to Radio/Media/Phone/Map* ¹ /Home/Settings/Pandora/Aha/Apps
Gas Prices	Changes screen to SiriusXM Travel Link Fuel Prices
Sports Scores	Changes screen to SiriusXM Travel Link Sports Scores
Stocks	Changes screen to SiriusXM Travel Link Stock Prices
Weather	Changes screen to SiriusXM Travel Link Weather
Go to Aha	Changes screen to Aha
Go to Pandora* ²	Changes screen to Pandora
Repeat	Play back last dialog prompt

Voice command	Function
Cancel	Cancels current dialog session

*1: 8-inch with Navi system only

*2: Pandora is only available in certain countries. Please visit pandora.com/legal for more information.

9

Appendix/What To Do If/Index



End User License Agreement	222
Certification	224
Certification	224
SiriusXM® Satellite Radio	224
SiriusXM Data Service	224
Radio Wave Communications	224
Bluetooth	227
iPhone/iPod	227
Apple CarPlay	228
Android Auto	228
Pandora	228

How To Get The Source Code Using The Open Source	229
What To Do If	230
Troubleshooting	230
Troubleshooting Issues Common To This System	230
SUBARU STARLINK	230
Radio Operation	231
Phone	232
Updating The System	237
Map Update	241
Index	247

END USER LICENSE AGREEMENT

These terms are binding between you, as the original purchaser (or original recipient) and Harman International Industries, Incorporated and its affiliates (“Harman”) for the software, services and support material, if any, that are the subject matter of these terms. By downloading, installing, or using the software that accompany these terms (collectively with any software components and related documentation, “Application”) in the product intended for use with the Application (“Product”), you agree to these terms. If you are using the Application and Services under these terms on behalf of a company, then you represent and warrant that you have the authority to contract on behalf of and bind your company. You represent and warrant that you have the legal capacity to enter into a binding agreement and that you are of the age of consent.

1. LICENSE.

1.1 Subject to your compliance with these terms, Harman grants you a non-exclusive and non-transferable license to use the Application as installed on the Product that you own or control. This license does not represent a sale of software or permission to lend, sell, redistribute, sublicense, lease or rent the Application to other parties.

1.2 Harman retains all rights, title and interest in and to the Application.

2. LICENSE RESTRICTIONS.

2.1 You may not use the Application outside of the Product. You may not use the Application on a network or on multiple devices at the same time.

2.2 You may not reproduce, modify, transfer, transmit, sublicense, or export the Application. You may not disassemble, decompile, reverse engineer the Application, and you may not allow others to do the same. To the extent you are permitted under applicable law to reverse engineer for interoperability purpose, you must first make a written request to Harman stating the reason to do so, and allow Harman opportunity to investigate and provide you with the necessary information.

2.3 You may not remove any copyright notices, trademark notices, or other proprietary notices or disclaimers or warnings on or embedded in the Application.

2.4 Harman owns all intellectual property rights in the Application and all modifications, updates, upgrades to and derivative works based upon the Application. Harman reserves all rights not expressly granted under these terms.

3. SERVICES

3.1 The Application may enable access to Harman’s and other third party services and web sites (collectively and individually, “Services”). You must accept any additional terms of services associated with the Services in order to use or access the Services. Harman is not responsible or liability for the Services or content that you may access through the Application (such as the accuracy, completeness, or operation of the content or services).

3.2 By using any of the Services, You may encounter content that may be deemed offensive, indecent, or objectionable to you. Your sole remedy is to simply stop viewing the content. Pages describing the Services are accessible worldwide but this does not mean all Services or service features are available in your country, or that user-generated content available via the Services is legal in your country. Harman may block access to certain Services (or certain service features or content) in certain countries. It is your responsibility to make sure your use of the Services is legal where you use them. Services are not available in all languages.

3.3 Harman may modify, update, or discontinue the Services, Application (including any of their portions or features) at any time without liability to you or anyone else. However, Harman will make reasonable effort to notify you before we make the change.

3.4 You may not reproduce, modify, distribute, sell, rent, lease, or create derivative works of the Services or content in any manner. You may not exploit the Services in any unauthorized way whatsoever, including but not limited to, by trespass or burdening network capacity. You must comply with applicable law. You may not use the Services in any manner to harass, abuse, stalk, threaten, defame or otherwise infringe or violate the rights of any other party, and that Harman is not in any way responsible for your use of the Services.

3.5 Harman may collect and use technical data and related information, including but not limited to technical information about the device, system, application software, and peripherals, that is gathered periodically to facilitate the provision of software updates, product support, and other services related to the Application. Harman may use this data, as long as it does not personally identify you, to improve its products or to provide services or technologies to you.

4. TERMINATION.

4.1 Without prejudice to any other rights, Harman may terminate these terms without notice if you fails to comply with these terms.

4.2 You may terminate these terms without notice to Harman by ceasing use of and destroying all copies of the Application, including all archival copies.

4.3 Upon termination of these terms for any reason, you must immediately cease use of the Application, and destroy all copies of the Application, including all archival copies.

5. DISCLAIMER OF WARRANTIES.

5.1 TO THE MAXIMUM EXTENT PERMITTED BY APPLICABLE LAW, HARMAN PROVIDES THE APPLICATION AND SERVICES “AS IS” AND WITH ALL FAULTS. HARMAN DISCLAIMS ALL OTHER WARRANTIES, WHETHER EXPRESS, IMPLIED OR STATUTORY, OR ARISING BY CUSTOM OR TRADE USAGE, INCLUDING BUT NOT LIMITED TO THE IMPLIED WARRANTIES OF MERCHANTABILITY, FITNESS FOR A PARTICULAR PURPOSE, AND NON-INFRINGEMENT OF THIRD PARTY RIGHTS.

5.2 HARMAN DOES NOT WARRANT THAT THE OPERATION OF THE APPLICATION OR SERVICES WILL BE UNINTERRUPTED OR ERROR-FREE, OR THAT DEFECTS IN THE APPLICATION OR SERVICES WILL BE CORRECTED. NO ORAL OR WRITTEN INFORMATION OR ADVICE GIVEN BY HARMAN OR ITS AUTHORIZED REPRESENTATIVE SHALL CREATE A WARRANTY. SHOULD THE APPLICATION OR SERVICES PROVE DEFECTIVE, YOU ASSUME THE ENTIRE COST OF ALL NECESSARY SERVICING REPAIR, OR CORRECTION.

6. LIMITATION OF LIABILITY.

6.1 In no event will Harman or its suppliers be liable for any special, indirect, consequential, incidental, or punitive damages however caused, regardless of the theory of liability, or whether arising out of the use of or inability to use the Application, even if Harman or its suppliers or licensors have been advised of the possibility of such damages. The limitation or exclusion does not apply to claims that cannot be excluded under applicable law.

6.2 Harman disclaims all liability with respect to damages arising from or caused, directly or indirectly, by the Application, the installation process for the Application or arising from or caused by these terms.

6.3 In no event will Harman's total liability to you for all damages (other than as may be required by applicable law) exceed \$50. The limitations in this Section 7 will apply to the maximum extent permitted by applicable law, even if any remedy fails its essential purpose.

7. GENERAL PROVISIONS.

7.1 These terms are governed by and construed in accordance with the substantive laws of the state of New York, excluding its conflict of law principles. You and Harman agree to exclude the United Nations convention on contracts for the international sale of goods under these terms and any transaction that may be implemented in connection with these terms. You and Harman agree that the subject matter and personal jurisdiction are proper in the courts located in United States of America District Court for the Southern District of New York. The prevailing party in any litigation arising from these terms is entitled to recover reasonable attorneys' fees and related expenses, in addition to any other relief granted. Your use of the Application may also be subject to other local, state, national, or international laws.

7.2 You may not assign or delegate all or any part of your rights or obligations under these terms without the prior written consent of Harman, except to a person or entity that accepts possession or title of the Product and who agrees to be bound by the terms of these terms.

7.3 Articles 4, 5, 6, and 7 will survive any termination or expiration of these terms.

7.4 Any amendment to or modification of these terms must be made in writing and signed by an authorized representative of both You and Harman. These terms are the complete and final agreement between You and Harman with respect to the subject matter of these terms. To the extent that any terms of any Harman policies or programs for support services conflict with these terms, these terms control.

7.5 If any provision of these terms is held to be void, invalid, unenforceable or illegal, the other provisions will continue in full force and effect.

7.6 The failure of either party to enforce any rights or obligations under these terms, or to take any action against the other party in the event of any breach, shall not be considered a waiver to subsequent enforcement of rights or subsequent actions in the event of future breaches.

7.7 Questions, complaints or claims with respect to the Application may be directed to Harman at Harman International Industries, Incorporated, 400 Atlantic Street, Stamford, CT 06901, Attention:

8. Export Controls.

The Application, documentation and technology or direct products supplied by Harman under these terms ("Technology"), are subject to export controls under applicable laws and regulations. You must comply with such laws and regulations governing export, re-export, import, transfer and use of the Technology and will obtain all required U.S. and local authorizations, permits, or licenses. In particular, but without limitation, the Technology may not be exported or re-exported (a) into any embargoed countries or (b) to anyone on the U.S. Treasury Department's list of Specially Designated Nationals or the U.S. Department of Commerce's Denied Persons or Entity List. By using the Application, You represent and warrant that you are not located in any such country or on any such list. You also agree that you will not use the Products for any purposes prohibited by United States law, including without limitation, the development, design, manufacture or production of nuclear, chemical, or biological missiles or weapons. You agree to provide any other information, support documents, and assistance as may reasonably be required in connection with securing authorizations or licenses.

9. Government Users.

The Application and documentation qualify as "Commercial Items," as that term is defined at Federal Acquisition Regulation ("FAR") (48 C.F.R.) §2.101, consisting of "Commercial Computer Software" and "Commercial Computer Software Documentation" as such terms are used in FAR §12.212. Consistent with FAR §12.212 and DoD FAR Supp. §227.7202-1 through §227.7202-4, and notwithstanding any other FAR or other contractual clause to the contrary in any agreement into which these terms may be incorporated, You may provide to a Government end user or, if these terms are direct, a Government user will acquire, the Application and documentation with only those rights set forth in these terms. Use of either the Application or documentation or both constitutes agreement by the Government that the Application and documentation are "Commercial Computer Software" and "Commercial Computer Software Documentation," and constitutes acceptance of the rights and restrictions in these terms.



CERTIFICATION

CERTIFICATION

SiriusXM® Satellite Radio



- © 2016 Sirius XM Radio Inc. Sirius, XM, SiriusXM and all related marks and logos are trademarks of Sirius XM Radio Inc. All other marks, channel names and logos are the property of their respective owners. All rights reserved.

SiriusXM DATA SERVICE

Neither SiriusXM nor Subaru is responsible for any errors or inaccuracies in the SiriusXM data services or its use in vehicle.

RADIO WAVE COMMUNICATIONS

► U.S.A.

- FCC § 15.19 Labelling requirements
 “This device complies with part 15 of the FCC Rules and Industry Canada license-exempt RSS standard(s). Operation is subject to the following two conditions:
 (1) This device may not cause harmful interference, and
 (2) this device must accept any interference received, including interference that may cause undesired operation.”

FCC § 15.21 Information to user

“Changes or modifications not expressly approved by the party responsible for compliance could void the user’s authority to operate the equipment.”

RF Exposure Requirements

To comply with FCC RF exposure compliance requirements, the device must be installed to provide a separation distance of at least 20 cm from all persons.

⚠ WARNING**● FCC WARNING**

Changes or modifications not expressly approved by the party responsible for compliance could void the user's authority to operate the equipment.

● CAUTION: Radio Frequency Radiation Exposure

This equipment complies with FCC radiation exposure limits set forth for an uncontrolled environment and meets the FCC radio frequency (RF) Exposure Guidelines. This equipment should be installed and operated keeping the radiator at least 20cm or more away from person's body in normal use position.

● Co-location: This transmitter must not be co-located or operated in conjunction with any other antenna or transmitter.**► Canada**

This device complies with part 15 of the FCC Rules and Industry Canada license-exempt RSS standard(s).

Operation is subject to the following two conditions:

- (1) This device may not cause harmful interference, and
- (2) this device must accept any interference received, including interference that may cause undesired operation.

Le présent appareil est conforme aux CNR d'Industrie Canada applicables aux appareils radio exempts de licence. L'exploitation est autorisée aux deux conditions suivantes : (1) l'appareil ne doit pas produire de brouillage, et (2) l'utilisateur de l'appareil doit accepter tout brouillage radioélectrique subi, même si le brouillage est susceptible d'en compromettre le fonctionnement.

⚠ WARNING**● CAUTION: Radio Frequency Radiation Exposure**

This equipment complies with IC radiation exposure limits set forth for an uncontrolled environment and meets RSS-102 of the IC radio frequency (RF) Exposure rules. This equipment should be installed and operated keeping the radiator at least 20cm or more away from person's body (excluding extremities: hands, wrists, feet and ankles).

ATTENTION: l'exposition aux rayonnements radiofréquence - Cet équipement est conforme aux limites d'exposition aux rayonnements énoncées pour un environnement non contrôlé et respecte les règles d'exposition aux fréquences radioélectriques (RF) CNR-102 de l'IC. Cet équipement doit être installé et utilisé en gardant une distance de 20cm ou plus entre le dispositif rayonnant et le corps (à l'exception des extrémités: mains, poignets, pieds et chevilles).

► México

- La operación de este equipo está sujeta a las siguientes dos condiciones: (1) es posible que este equipo o dispositivo no cause interferencia perjudicial y (2) este equipo o dispositivo debe aceptar cualquier interferencia, incluyendo la que pueda causar su operación no deseada.

Bluetooth



- The Bluetooth® word mark and logos are registered trademarks owned by Bluetooth SIG, Inc. and any use of such marks by SUBARU CORPORATION is under license. Other trademarks and trade names are those of their respective owners.

iPhone/iPod



- Use of the Made for Apple badge means that an accessory has been designed to connect specifically to the Apple product(s) identified in the badge and has been certified by the developer to meet Apple performance standards. Apple is not responsible for the operation of this device or its compliance with safety and regulatory standards.
- Please note that the use of this accessory with an Apple product may affect wireless performance.
- iPhone, iPod, iPod classic, iPod nano, iPod touch, Lightning and App Store are trademarks of Apple Inc., registered in the U.S. and other countries and regions.

Apple CarPlay



- Use of the Apple CarPlay logo means that a vehicle user interface meets Apple performance standards. Apple is not responsible for the operation of this vehicle or its compliance with safety and regulatory standards. Please note that the use of this product with iPhone or iPod may affect wireless performance.
- Apple, iPhone, iPod, iPod touch and Apple CarPlay are trademarks of Apple Inc., registered in the U.S. and other countries and regions.

Android Auto

androidauto

- Android Auto is a trademark of Google LLC.

Pandora



- Pandora, the Pandora logo, and the Pandora trade dress are trademarks or registered trademarks of Pandora Media, Inc. Used with permission.

HOW TO GET THE SOURCE CODE USING THE OPEN SOURCE

This product contains open source software, some of which is licensed under the GPL. For your convenience, the source code and relevant build instruction for software licensed under the GPL is available at

<http://www.harmanardon.com/opensource.html>.

You may also obtain this information by contacting us at:

[MAILING ADDRESS]

or OpenSourceSupport@Harman.com

WHAT TO DO IF

TROUBLESHOOTING

TROUBLESHOOTING ISSUES COMMON TO THIS SYSTEM

Symptom	Cause	Action
The touch screen becomes unresponsive during operation.	An error has occurred in the system.	Press and hold the “  /VOLUME” knob for 10 seconds or longer to reset the system.
The sound suddenly stops working.		
Only the background is displayed on the screen and no icons appear.		

SUBARU STARLINK

► 8-inch system only

Symptom	Likely cause	Solution	Page
SUBARU STARLINK does not start.	The time does not match.	Connect your smartphone.	58
		Set the phonebook download function to on.	61

RADIO OPERATION

Experience	Cause	Action
Mismatch of time alignment- a user may hear a short period of programming replayed or an echo, stutter or skip.	The radio stations analog and digital volume is not properly aligned or the station is in ballgame mode.	None, radio broadcast issue. A user can contact the radio station.
Sound fades, blending in and out.	Radio is shifting between analog and digital audio.	Reception issue, may clear-up as the vehicle continues to be driven. Turning the indicator of the HD Radio button off can force radio in an analog audio.
Audio mute condition when an HD2/HD3 multicast channel had been playing.	The radio does not have access to digital signals at the moment.	This is normal behavior, wait until the digital signal returns. If out of the coverage area, seek a new station.
Audio mute delay when selecting an HD2/ HD3 multicast channel preset.	The digital multicast content is not available until HD Radio™ broadcast can be decoded and make the audio available. This takes up to 7 seconds.	This is normal behavior, wait for the audio to become available.
Text information does not match the present song audio.	Data service issue by the radio broadcaster.	Broadcaster should be notified.
No text information shown for the present selected frequency.	Data service issue by the radio broadcaster.	Broadcaster should be notified.

PHONE

If there is a problem with the hands-free system or a Bluetooth phone, first check the table below.

► When using the hands-free system with a Bluetooth phone

Symptom	Likely cause	Solution	Page	
			Cellular phone	This system
The hands-free system or Bluetooth phone does not work.	The connected Bluetooth phone may not be a compatible Bluetooth cellular phone.	For a list of specific Bluetooth phones which operation has been confirmed on this system. For USA customers, please visit www.subaru.com for details. Outside of the USA customers, contact your local dealer to arrange a demonstration in order to confirm whether or not the phone can be paired with the vehicle.	*	53
	The Bluetooth version of the connected cellular phone may be older than the specified version.	Use a cellular phone with Bluetooth version 1.1 or higher. Recommended: Ver. 3.0 +EDR or higher	*	53

*: For details, refer to the owner's manual that came with the cellular phone.

► When registering/connecting a cellular phone

Symptom	Likely cause	Solution	Page	
			Cellular phone	This system
A cellular phone cannot be registered.	An incorrect passcode was entered on the cellular phone.	Enter the correct passcode on the cellular phone.	*	-
	The registration operation has not been completed on the cellular phone side.	Complete the registration operation on the cellular phone (approve registration on the phone).	*	-
	Old registration information remains on either this system or the cellular phone.	Delete the existing registration information from both this system and the cellular phone, then register the cellular phone you wish to connect to this system.	*	60
A Bluetooth connection cannot be made.	Another Bluetooth phone is already connected.	Manually connect the cellular phone you wish to use to this system.	-	58
	Bluetooth function is not enabled on the cellular phone.	Enable the Bluetooth function on the cellular phone.	*	-

*: For details, refer to the owner's manual that came with the cellular phone.

► When making/receiving a call

Symptom	Likely cause	Solution	Page	
			Cellular phone	This system
A call cannot be made/received.	Your vehicle is in a "No Service" area.	Move into the service area.	-	-

► When using the phonebook

Symptom	Likely cause	Solution	Page	
			Cellular phone	This system
Phonebook data cannot be transferred automatically.	The profile version of the connected cellular phone may not be compatible with transferring phonebook data.	For a list of specific Bluetooth phones which operation has been confirmed on this system. For USA customers, please visit www.subaru.com for details. Outside of the USA customers, contact your local dealer to arrange a demonstration in order to confirm whether or not the phone can be paired with the vehicle.	*	53
	Automatic contact transfer function on this system is set to off.	Set automatic contact transfer function on this system to on.	-	61

*: For details, refer to the owner's manual that came with the cellular phone.

► **When using the Bluetooth message function**

Symptom	Likely cause	Solution	Page	
			Cellular phone	This system
Messages cannot be viewed.	Message transfer is not enabled on the cellular phone.	Enable message transfer on the cellular phone (approve message transfer on the phone).	*	-

*: For details, refer to the owner's manual that came with the cellular phone.

► In other situations

Symptom	Likely cause	Solution	Page	
			Cellular phone	This system
Even though all conceivable measures have been taken, the symptom status does not change.	The cellular phone is not close enough to this system.	Bring the cellular phone closer to this system.	-	-
	The cellular phone is the most likely cause of the symptom.	Turn the cellular phone off, remove and reinstall the battery pack, and then restart the cellular phone.	*	-
		Enable the cellular phone's Bluetooth connection.	*	-
		Stop the cellular phone's security software and close all applications.	*	-
		Before using an application installed on the cellular phone, carefully check its source and how its operation might affect this system.	*	-

*: For details, refer to the owner's manual that came with the cellular phone.

UPDATING THE SYSTEM

If a problem occurs when attempting to perform a system update, refer to the following table.

Symptom	Cause	Solution
Cannot connect to Wi-Fi network.	Attempted to connect to Wi-Fi network device with wrong device name (SSID)	Check the settings and operation of the Wi-Fi network device.
	Incorrect Wi-Fi password entered.	
	Max number of devices connected already connected to desired Wi-Fi network device.	
	Wi-Fi signal is weak.	
	Vehicle is out of range of Wi-Fi network device.	
	Wi-Fi network device service contract has expired.	

Symptom	Cause	Solution
<p>“Connect To Wi-Fi” is displayed when Check for Updates (Check for Updates) is selected.</p>	System is not connected to Wi-Fi network device.	Connect system to Wi-Fi network device. (→P.69)
	Wi-Fi network device does not have internet access.	Check Wi-Fi network device.
	System is not connected to or has connection problem with Wi-Fi network device.	<p>On the “Wi-Fi” screen, turn the Wi-Fi setting off and then back on. (→P.63)</p> <p>If the symptom reoccurs, perform the following procedure:</p> <ol style="list-style-type: none"> 1) Select the desired Wi-Fi network device (SSID) on the “Wi-Fi Settings” screen. (→P.69) 2) Select Forget This Network (Forget This Network). 3) Select the desired Wi-Fi network device (SSID) again and input the password to connect the device.
<p>“Software download failed. Do you want to retry?” is displayed when Check for Updates (Check for Updates) is selected.</p>	System may not have been able to receive clock information correctly.	<p>8-inch with Navi system: Move the vehicle to where GPS signals can be received.</p> <p>8-inch system: Connect a smartphone to the system using Bluetooth and transfer the phonebook data. (→P.58, 61)</p>
	Wi-Fi network device service contract has expired.	Check the settings and operation of the Wi-Fi network device.
	Communication problem with Aha app.	If updating using the Aha smartphone app, force close and restart the Aha app, then try again.

Symptom	Cause	Solution
Download progress bar is not displayed.	Download of update to smartphone has not completed.	<p>Check the download progress on Aha app of the smartphone. When download of the update to the smartphone has completed, it will transfer the data to the system and the system will then display the download progress.</p> <p>If using the iOS Aha app, the download progress will not be displayed on the app. Wait until download has completed.</p> <p>The download time may vary depending on the size of the update data and communication status.</p>
Download progress stops for a long time.	Communication problem with Aha app.	If updating using the Aha smartphone app, force close and restart the Aha app, then try again.
	Communication problem with smartphone.	If updating using the Aha smartphone app, disconnect the smartphone from the system, close the Aha smartphone app, connect it again using Bluetooth/USB (→P.34, 58) and then start Aha app again.
Download is stopped and cannot be resumed.	Communication with Wi-Fi network device or smartphone was cut.	Check the Wi-Fi network connection. Check the connection of the smartphone (Bluetooth connection and Aha smartphone app status). (→P.39)
Cannot resume install after selecting Cancel (Cancel) on “Software Update Ready To Install” pop-up screen.	-	Downloads cannot be resumed if canceled, perform update procedure again. (→P.74)

Symptom	Cause	Solution
Installation does not complete (system restarts continuously).	-	<p>Wait until the home screen is displayed.</p> <ul style="list-style-type: none"> Depending on the software version you are updating from, updating may be performed in multiple steps and the system may restart multiple times. This is not a malfunction.
"Software update install failed" is displayed.	The system software has been corrupted.	<p>Have the software updated by your SUBARU dealer immediately.</p> <p>In this case, none of the system functions, other than the rear camera, will operate. When using the rear camera, only the camera image will be displayed, guide lines, etc. will not be displayed.</p> <p>If this message is displayed, the system will restart every 180 seconds. In this situation, turn the ignition switch to the "LOCK"/"OFF" position, open and close the driver's side door and check that the system is off. If any door is open when the ignition switch is turned to the "LOCK"/"OFF" position, the system may not turn off.</p>

MAP UPDATE (8-inch with Navi system only)

If a problem occurs when attempting to perform a map update, refer to the following table.

► Errors when updating via Wi-Fi, smartphone

Error code	Cause	Solution
101	The update package received is not valid for this device.	Update the map data using a USB memory device. (→P.202) Then, perform the following procedure: Turn the ignition switch to the "LOCK"/"OFF" position → Open the driver's side door → Close the door → Wait for 3 minutes or more → Start the engine. If the update cannot be completed successfully, contact your SUBARU dealer.
103	There is not enough space for the update package	Perform a factory reset to free up space (→P.63) and perform the update again. (→P.201) Then, perform the following procedure: Turn the ignition switch to the "LOCK"/"OFF" position → Open the driver's side door → Close the door → Wait for 3 minutes or more → Start the engine. If the update cannot be completed successfully, contact your SUBARU dealer. CAUTION: When a factory reset is performed, various settings (driver profile, paired Bluetooth devices, radio presets, audio settings, etc.) will be reset.
104	The update package is older than the current package on the device.	The system map data is the latest version. Update is not necessary.

Error code	Cause	Solution
106	Compatibility error with map data and navigation system	<p>Update the map data using a USB memory device. (→P.202) Then, perform the following procedure: Turn the ignition switch to the "LOCK"/"OFF" position → Open the driver's side door → Close the door → Wait for 3 minutes or more → Start the engine. If the update cannot be completed successfully, contact your SUBARU dealer.</p>
107	Connection Error Wi-Fi/Hotspot internet connection not available or internet not reachable.	<ol style="list-style-type: none"> 1) Check the Wi-Fi network signal. (→P.39) If possible, move the vehicle to an area where the signal is better and communication is possible. 2) Attempt the update again. (→P.201) 3) If the update cannot be performed, perform the following: Turn the ignition switch to the "LOCK"/"OFF" position → Open the driver's side door → Close the door → Wait for 3 minutes or more → Start the engine. 4) Attempt the update again. (→P.201) 5) If the update cannot be performed, update the map data via USB memory. (→P.202) 6) Repeat "STEP 3". 7) If the update cannot be completed successfully, contact your SUBARU dealer.

► Errors when updating via smartphone

Error code	Cause	Solution
108	Aha Phone App error Service Not Authenticated	Update the map data using a USB memory device or Wi-Fi network. (→P.202, 203) Then, perform the following procedure or contact your SUBARU dealer. Turn the ignition switch to the "LOCK"/"OFF" position → Open the driver's side door → Close the door → Wait for 3 minutes or more → Start the engine.
109	Aha Phone App error Service Not Enabled	
110	Aha Phone App error Unknown Error	1) Turn the ignition switch to the "LOCK"/"OFF" position → Open the driver's side door → Close the door → Wait for 3 minutes or more → Start the engine. 2) Attempt the update again. (→P.204) 3) If the update cannot be performed, update the map data using a USB memory device or Wi-Fi network. (→P.202, 203) 4) Repeat "STEP 1". 5) If the update cannot be completed successfully, contact your SUBARU dealer.
111	Aha Phone App error Server Error	

Error code	Cause	Solution
112	Aha Phone App error Timeout	1) Check the network signal. (→P.39) If possible, move the vehicle to an area where the signal may be better and communication is possible.
113	Aha Phone App error Invalid Response	2) Attempt the update again. (→P.204) 3) If the update cannot be performed, perform the following procedure: Turn the ignition switch to the "LOCK"/"OFF" position → Open the driver's side door → Close the door → Wait for 3 minutes or more → Start the engine. 4) Attempt the update again. (→P.204) 5) If the update cannot be performed, update the map data using a USB memory device or Wi-Fi network. (→P.202, 203) 6) Repeat "STEP 3". 7) If the update cannot be completed successfully, contact your SUBARU dealer.
114	Not enough space on phone	Free up sufficient space on the smartphone and attempt to download the map update data again (→P.204), or update the map data using a USB memory device or Wi-Fi network. (→P.202, 203) Then, perform the following procedure: Turn the ignition switch to the "LOCK"/"OFF" position → Open the driver's side door → Close the door → Wait for 3 minutes or more → Start the engine.
115	Data size restriction on phone Reached data restriction on the mobile phone.	The connected smartphone has exceeded its data plan limit. Update the map data using a USB memory device or Wi-Fi network. (→P.202, 203) Then, perform the following procedure: Turn the ignition switch to the "LOCK"/"OFF" position → Open the driver's side door → Close the door → Wait for 3 minutes or more → Start the engine.

Error code	Cause	Solution
116	Invalid request data	<p>Perform a factory reset (→P.63) and attempt the update again (→P.204), or update the map data using a USB memory device or Wi-Fi network. (→P.202, 203) Then, perform the following procedure: Turn the ignition switch to the "LOCK"/"OFF" position → Open the driver's side door → Close the door → Wait for 3 minutes or more → Start the engine.</p> <p>CAUTION: When a factory reset is performed, various settings (driver profile, paired Bluetooth devices, radio presets, audio settings, etc.) will be reset.</p>
117	Internal Error	<ol style="list-style-type: none"> 1) Turn the ignition switch to the "LOCK"/"OFF" position → Open the driver's side door → Close the door → Wait for 3 minutes or more → Start the engine. 2) Attempt the update again. (→P.204) 3) If the update cannot be performed, update the map data using a USB memory device or Wi-Fi network. (→P.202, 203) 4) Repeat "STEP 1". 5) If the update cannot be completed successfully, contact your SUBARU dealer.

Error code	Cause	Solution
128	Installation failed	<p>Perform a factory reset (→P.63) and attempt the update again (→P.204), or update the map data using a USB memory device or Wi-Fi network. (→P.202, 203) Then, perform the following procedure:</p> <p>Turn the ignition switch to the "LOCK"/"OFF" position → Open the driver's side door → Close the door → Wait for 3 minutes or more → Start the engine.</p> <p>CAUTION: When a factory reset is performed, various settings (driver profile, paired Bluetooth devices, radio presets, audio settings, etc.) will be reset.</p>

INDEX

A

aha™ by HARMAN	112
AM radio	132
Android Auto	121
Apple CarPlay.....	119
AUX	159

B

Bluetooth	52
Profiles.....	53
Registering Bluetooth device	52
Bluetooth audio.....	156
Bluetooth phone message.....	97

C

Calling on Bluetooth phone	90
By contacts list.....	93
By favorites list.....	92
By keypad	93
By last number.....	91
By recent calls list.....	92
CD	149
Clock settings	82
Command list.....	215

D

Destination search.....	182
-------------------------	-----

E

Entering letters, numbers/list screen	37
Entering letters/numbers.....	37
List screen operation	38

F

FM radio	132
----------------	-----

G

General settings	63
GPS	199
Limitations.....	199

H

Hands-free system	86
Home screen operation	40
Adding shortcut icons	40
Moving/deleting shortcut icons	41

I

Initial screen	32
iPod	153

M

Map data	201
Update	201
Map screen information	176
Map screen operation	174
Current position display	174
Map scale	175
Orientation of the map	175
Media operation	149
AUX	159
Bluetooth audio	156
CD	149
iPod	153
USB memory	151
Memory points settings	178

N

Navigation settings	197
---------------------------	-----

P

Pandora	116
Phone settings	55

R

Radio operation	132
AM/FM radio	132
SiriusXM® satellite radio	138
Rear view camera	43
Receiving on Bluetooth phone	94
Incoming calls	94
Route guidance	190
Route related functions	193
Adding destinations	194
Checking itinerary	195
Checking route	193
Deleting destinations	196
Editing route	194
Reordering destinations	195
Stopping guidance	196
Weather information	196

S

Screen adjustment.....	39
Adjusting brightness	39
Day and night mode.....	39
Search operation	182
Favorite places list	186
Gas stations.....	187
Home/work.....	182
On the map.....	183
POI.....	184
Previously set destinations	185
Search word.....	183
Setting	51
General.....	63
Navigation.....	197
Phone	55
Sound	77
Vehicle	80
Siri	210
SiriusXM® satellite radio	138
SiriusXM Travel Link.....	123
Sirius XM weather alert	42
Sound settings.....	77
Status display	39
Steering wheel controls	161
SUBARU STARLINK	107

T

Talking on Bluetooth phone	95
Call waiting	96
Sending tones.....	95
Touch screen gestures	34
Touch screen operation	36
Traffic information	177
Troubleshooting.....	230
Typical voice guidance prompts	193

U

USB memory	151
------------------	-----

V

Vehicle customization	80
Voice recognition system.....	213

W

Weather information	196
---------------------------	-----

