



Po Box 6245
Silverwater 2128
www.bdirect.com.au
warranties@bdirect.com.au

Consumer Warranty

MyGenie would like you to enjoy your new purchase
This warranty card is provided to ensure that you get satisfaction

Our goods come with guarantees that cannot be excluded under Australian Consumer Law. You are entitled to a replacement or refund for a major failure for any other reasonably foreseeable loss or damage.

You are also entitled to have the goods repaired or replaced if the goods fail to be of acceptable quality and the failure does not amount to a major failure. The benefits of this warranty are in addition to the consumer's rights and remedies under law.

Warranty Period

The warranty is 12 months from the date of purchase

Registering Your Purchase

Please register your purchase on www.bdirect.com.au –register your purchase

Procedure for claiming under warranty

Should you need to make a claim under this warranty please follow the prompts on www.bdirect.com.au – warranty claims or email direct to warranties@bdirect.com.au

Please retain your original receipt as proof of purchase



X1000 PRO Instruction Manual



Thank you for purchasing this product, which has been made to demanding high quality standards and is guaranteed for domestic use against manufacturing faults for a period of 12 months from date of purchase

For correct usage, read these instructions carefully and keep in a safe place for future reference

Table of Contents







| | |
|---|-------|
| Table of Contents | 01 |
| Safety Instructions | 02 |
| Advanced features | 03-04 |
| Product introduction | 05 |
| Structure of the cleaner | 06 |
| Panel of the cleaner | 07-08 |
| Battery installation for the cleaner | 08 |
| Introduction of the auto charging dock station | 09 |
| Introduction of the remote controller | 10 |
| Settings of the intelligent Water tank | 11 |
| Settings of schedule/time for the remote controller | 12 |
| Introduction of the virtual house | 13 |
| Installation & removal and cleaning of the dust bin | 14 |
| Installation of the intelligent water tank/trailing bar/mop | 15 |
| Common failures and troubleshooting | 16 |
| Dimensions and Parameters | 17 |

Safety Instructions













Before using this product, please read the following safety instructions and follow all routine safety precautions!

- Please read these instructions carefully.
- Please properly keep this book of instructions.
- Any operation not in compliance with this book is likely to cause damage to the product.
- The right to final interpretation resides in the Company.

Warning

| | | | |
|---|---|--|---|
| <p>Anyone except our designated service technicians may not disassemble, repair or modify the product. Otherwise it may lead to fire, electric shock or injury.</p> |  | <p>Do not use any recharger other than the one accompanying this appliance. Otherwise it may cause fire resulting from product damage, electric shock or high voltage.</p> |  |
| <p>Do not touch any high voltage power cable of the appliance with wet hands, as this may cause electric shock.</p> |  | <p>Not over bend the power cord or place heavy objects on it. Doing so may damage the cord, causing a fire or electric shock.</p> |  |
| <p>Attention must be paid to avoid clothes or any part of body (head, fingers, etc.) getting involved in the brush or wheels of the vacuum cleaner. Doing so may result in personal injury.</p> |  | <p>Keep it from cigarettes, lighters, matches and heat source objects and from flammable materials (such as using gasoline to clean the machine).</p> |  |

Attention

| | | | |
|--|---|--|---|
| <p>Turn off the power before transporting or relegating it to prolonged storage. Otherwise, the battery may be damaged.</p> |  | <p>Plug the power cord of the recharger tight, or it may cause electric shock, short circuit, smoke or fire.</p> |  |
| <p>Check the connection between the recharger and the socket for reliability. Otherwise it may result in non-charging and consequential fire.</p> |  | <p>To prolong battery life, recharge it for at least 16 hours after the first use or before reuse after a long idle period. The battery will not achieve its optimum performance until 2-3 complete recharging-discharging cycles.</p> |  |
| <p>Before leave vacuum cleaner to a long idle period, please recharge the battery to its full, then take the battery to a cool place, keep bottom to keep the bottom of the appliance dry.</p> |  | <p>Prior to use, remove all damage-prone objects (luminous objects, fabrics, glass bottles, etc.). Otherwise it may cause damage to these objects, or affect the performance the appliance.</p> |  |
| <p>Please use the cleaner with caution in the presence of children to avoid being starting or hurting them.</p> |  | <p>Do not stand or sit on the vacuum cleaner so as not to cause damage to it or injuries to human.</p> |  |
| <p>Attention: Do not let the robot inhale water and other liquids, Otherwise it may lead to product damage.</p> |  | <p>Do not use the vacuum cleaner in confined spaces (small table, chair) which may lead to product damage.</p> |  |
| <p>Outdoor use is prohibited, as doing so may cause product damage.</p> |  | <p>Do not use the vacuum cleaner on commercial premises, otherwise product damage may follow excessive use.</p> |  |

Advanced features

01. Patent Intelligent programmable water tank

The cleaner can control the water seeping speed of the water tank automatically ,you may select the water seeping speed also through the remote controller to achieve the optimum uniform wet mopping effect. When charging, the water seeping will be shut automatically. This is a protection to prevent current leakage which results from water residue on the ground .

02. Multi-function double dustbin

Each package include two dustbins: one large capacity dustbin 0.9L used for normal vacuum cleaning, and one big capacity water tank (0.6L) combined with one small dustbin (0.25L) used for wet mopping

03. Patent 3D filter

The 3D conditioning level filter (effectively preventing suction plugged when dustbin close to full) + HEPA filter prevent a secondary air pollution. The dust bin and 3D filter can be washed directly.

04. Two-way virtual house

The virtual house can creates one or two infrared beam that the cleaner will not cross; suitable for setting the off-limited areas.

Advanced features

05. Super suction power

The suction power of the cleaner is up to 40W, and even fine dust will be cleaned up;

06. Intelligent suction adjustment

When detecting a lot of rubbish, the cleaner will adjust the suction power automatically, which not only greatly improves the cleaning efficiency, but also save as much as about 30% of the electricity;

07. Garbage detection

When detecting garbage, the cleaner will automatically increase suction power; when the dust bin is full, the cleaner will give automatic voice prompt, and light up the " " icon on the display panel;

08. User-friendly design

Regardless of elders or children, a simple touch on the " " on the cleaner and cleaner will run automatically.

09. Design of super wide off-road wheel

Super wide wheel will resolve the slipping problem which occurs to the cleaner when it wet mopping.

Product introduction

This product can be used in cleaning family homes, hotel rooms, and small offices, and cleans well a variety of short-pile carpets, wood floors, and ceramic tile ,etc.

Functionality overview

It works on a rechargeable lithium-ion battery and under intelligent microcomputer control. It is an intelligent vacuum cleaner featuring UV sterilization, auto cleaning, vacuuming, intelligent wet mopping, timing, schedule cleaning, remote control, multiple identification protection functions, various automatic cleaning modes, and automatic recharging.

Cleaner and accessories

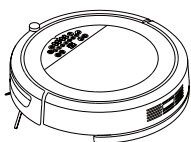

Cleaner × 1

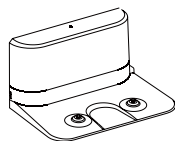

Charging dock station × 1

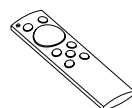

Remote control × 1

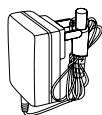

Power adapter × 1

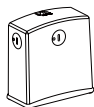

Virtual house × 1

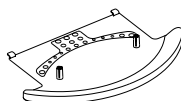

Trailing bar × 1

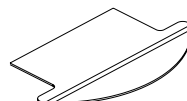

Mop × 2

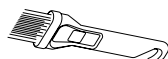

Cleaning brush × 1
(mounted on the dust bin)



HEPA × 1



Instruction manual × 1



small dust bin × 1



water tank × 1

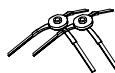

Side brush × 4
(Please fix 2 on the cleaner before
use payattention left or right)

Structure of the cleaner

Unit top

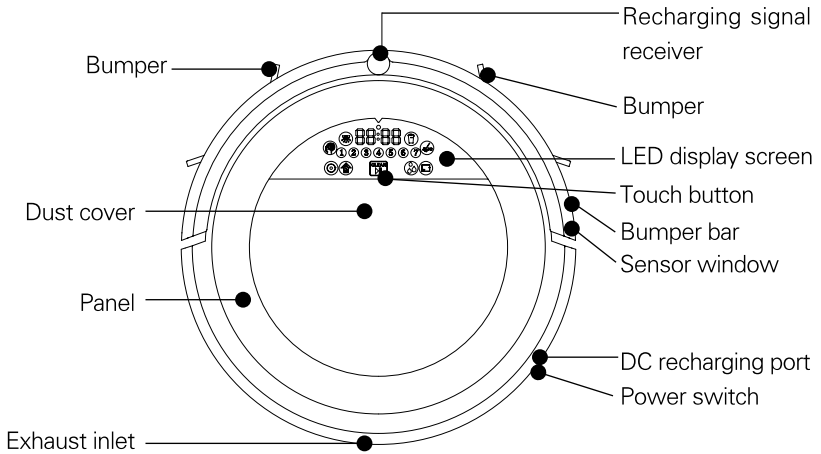

Unit bottom

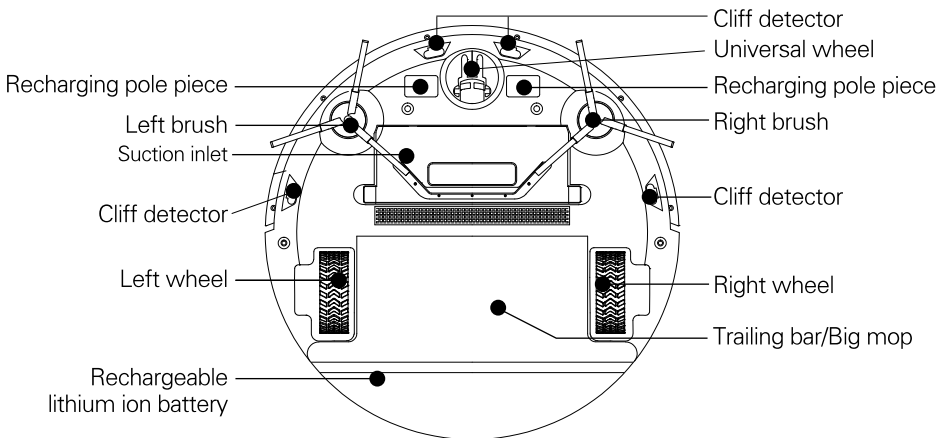

Panel the cleaner

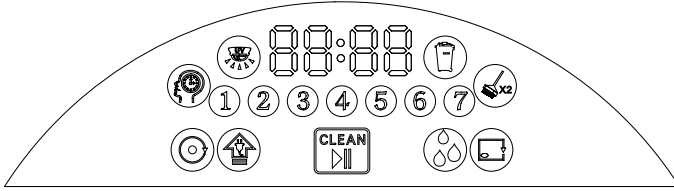

Before cleaning, tidy up the small items or obstacles in the room, especially the power cord and other easy entanglements; where the battery is low during cleaning, the cleaner will stop cleaning and give five beeps, light up the recharging touch light, and automatically rolling back to the docking station.



Auto cleaning button

Press this button and the cleaner will start automatic cleaning until the power is low at which point of time it will automatically go back to the auto charging dock station. In the course of cleaning, touch this button and the cleaner will stop.



Spot cleaning indicator

When this button is on, it will automatically enter into a spot cleaning mode in a spiral pattern within about 1 square meter for approximately 2–3 minutes; in the course of cleaning process, press any button on the remote controller, it will stop.



Docking indicator

Press the "HOME" on the remote control, and as this button is on, the cleaner will seek the docking station for charging automatically.



Schedule indicator

Press TIMER "TIMER" button and SPOT "SPOT" button on the remote controller, the "TIMER" icon on the cleaner panel will be on, and the cleaner enters into the current week day hour/minute setting and schedule week day, hour/minute setting (see page 11 for the schedule setting of the remote controller).



Digital indicator

- a. An error code will be displayed for an error, for instance: E001 will be displayed as "E001"
- b. Display week day, hour/minute, for instance: Tuesday 08:28A.M. will be digitally displayed as 2nd "08:28".
- c. Recharging display: "1111" In the course of recharging, a "1" will be lit up in turn on the When it is charged full capacity, "FULL" is displayed.
- d. Display of weekday: 1,2,3,4,5,6,7



Attention: Before charging, make sure turn the power switch of the cleaner to ON!

Panel of the cleaner



Garbage

The "🗑️" icon lit up on the cleaner indicating the suction inlet is blocked or the dust bin is full, or the garbage sensors is covered with dust.



Display of FULL GO

When the cleaner at stands by status, press the "🔙" on the remote controller and the cleaner will enter the FULL GO mode. (Definition of FULL GO: When choose this function , then the cleaner will automatically clean one more time after it is fully charged again.)



Display of wall follow cleaning

When the cleaner stands by, press "🏠" on the remote controller, and the cleaner will enter the wall follow cleaning mode.



Display of water seeping speed of the Intelligent water tank

First install the small dustbin with the intelligent water tank (refer to page18 for the installation method), the cleaner will automatically launch to the water tank mopping mode. Press the "🚰" button to start auto cleaning& mopping and the "🌀" will be lit up or blinking.

when the water tank runs out of water, this icon will light off, display error code E012; and made a voice prompt"inject water , please"; if want to continue this function during cleaning, please take out the water tank and refill it(The default mode is the indicators are normally on(standard water seeping speed , and blinking indicates it is in fast water seeping speed, as configured in the settings by the remote controller. See page11 for more).



Attention

1. It is suggested to clean the suction inlet and dust sensor each time emptying the dust bin.
2. When the cleaner is at work, the cleaning path follows default Settings but when it detects any dust, it will automatically switch to focused spiral cleaning.
3. To maximize the wet mopping effect; Before start, please refill the water tank to the fullest.

Battery installation for the cleaner

1. To install the cleaner battery, please use a screwdriver to loosen the four screws on the half-moon shaped bottom shell, and remove the battery installation cover (see Fig.1).
2. When installing the battery, please correctly connect the snap joints of the two terminals (see Fig. 2).
3. When not in use, place the cleaner into recharging status, which will maintain the battery in optimal use.
4. If the machine is left unused for a long time, please recharge the cleaner once a month on a regular basis to maintain the battery in optimal use.
5. The battery can only be replaced with the battery from the original manufacturer, otherwise it may cause damages or accidents to the cleaner.

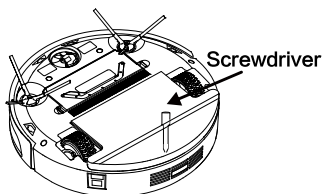

Fig.1

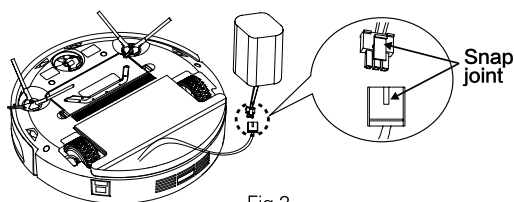

Fig.2

Introduction of the auto charging dock station

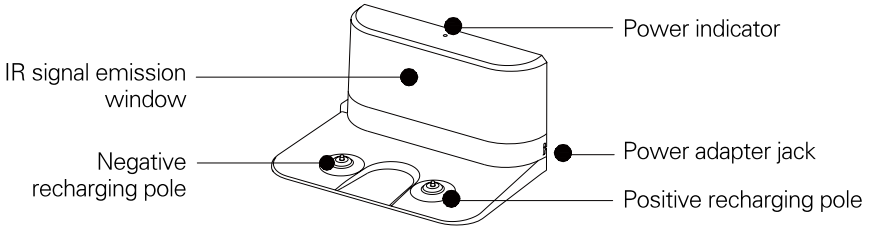

Fig.1

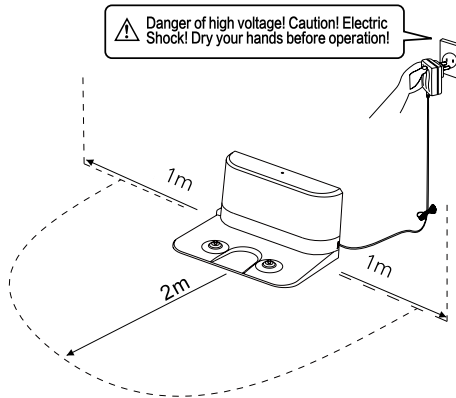

Fig.2

Instructions for the charging dock station

1. Securely mount the charging dock station onto a flat ground and a wall near and perpendicular to the ground.
2. Avoid obstacles and uneven areas within 2m in front of the docking station and 1 m on both sides.
3. If the infrared signal emission surface of the docking station is blocked, the cleaner will be unable to find the docking station for charging .
4. Please keep tidy the DC power cord of the docking station, and do not put the power cord on the ground, otherwise it will affect to search the docking station

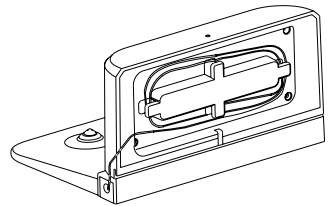

Fig.3

Introduction of the remote controller

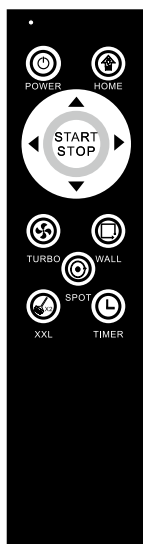

Fig.1

Button functions of the remote controller

- Press "HOME" and the cleaner will enter the auto charging mode.
- Press "POWER" and the cleaner will enter the sleep/wake-up mode (in sleep mode, press and hold this button for 10 seconds to enter the wake-up mode).
- Press "TURBO" and the cleaner will enter the Turbo cleaning mode, suitable for very dirty floor or hairy carpet.
- Press "WALL" and the cleaner will enter the wall follow cleaning mode.
- Press "SPOT" and the cleaner will enter the spot cleaning mode.
- Press "XXL" and the cleaner will enter the FULL GO mode.
- Press "TIMER" and the cleaner will enter the Settings of appointment/time, UV lamp ON/OFF, Water tank outflow (this is a combination button, see page 11-12 for more).
- Press "START/STOP" and the cleaner will enter the automatic cleaning mode.
- Press "▲" and the cleaner will start forward movement.
- Press "▼" and the cleaner will start backward movement.
- Press "◀" and the cleaner will start leftward movement.
- Press "▶" and the cleaner will start rightward movement.

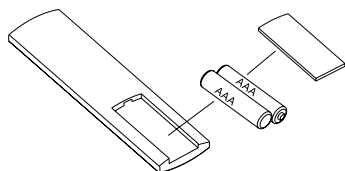

Fig.2

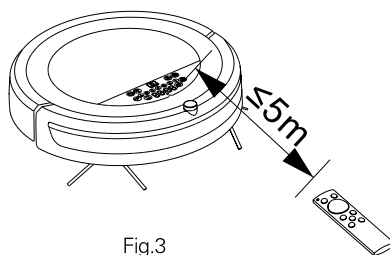

Fig.3











Attention

1. Place two AAA batteries to use the remote controller. (As shown in Fig. 2)
2. When controlling the cleaner with the remote controller, aim the controller at the sensor head of the cleaner, and keep it within 5M from the cleaner.

Settings of the intelligent water tank on the remote controller

1. Settings of the intelligent water tank :

At default mode from the factory, it is standard water seeping mode; if you want to use quick water seeping mode, follow the follow guide for setting.

- a. In standby mode, press the "  "button, then press the "  "button to enter the Settings of the water tank seeping speed (the water droplet icon "  "on the cleaner will flash);
- b. Press the "  "button, and the "  "on the cleaner is on, the screen displays "1111", indicating the water tank is in a standard water seeping mode, suitable for wooden floor, as too much water will ruin the wooden floor. This mode is also suitable for clean floor.
- c. Press the "  "button to save the current settings and return to the standby mode.
- d. Press the "  "button, the "  "on the cleaner is off, the screen displays "0000"; indicating the water tank is in a quick water seeping mode, suitable for tile/marble floor or dirty floor.
- e. Press the "  "button to save the current settings and return to the standby mode.





Attention

**Can only use water tank for floor wet mopping;
Only after vacuum cleaning, or use the floor have less large
garbage.**



Settings of Schedule/time for the remote controller

1. Settings of current week day, hour/minute

a. Settings of current week day:



In the standby mode, press the  "button, then press the  "button to enter the Settings of current week day; press the "◀", "▶" buttons to switch Monday/Sunday; Press the "▲" button until it is normally on to select a week day; press the "▼" button until it flashes to cancel a week day; Press the  "to save the current week day and enter the settings of current hour/minute;

b. Settings of current hour/minute:



After the Settings of current week day is done, press the  "button to enter the specific Settings of current hour/minute.
Press the "◀" and "▶" buttons to switch hour/minute;
Press the "▲" button to increment the current time, and press the "▼" button vice versa;
Press the  "button to save the Settings of appointment hour/minute and exit to the standby mode;

2. Settings of Schedule cleaning

a. Settings of Schedule week day:

In the standby mode, press the  "button, then press the  "button to enter the Settings of schedule week day; press the "◀", "▶" buttons to switch Monday/Sunday; Press the "▲" button until it is normally on to select a week day ; press the "▼" button until it flashes to cancel a week day; Press the  "to save the appointed week day and enter the Settings of appointed hour/minute;

b. Settings of schedule hour/minute:

After the Settings of schedule week day is done, press the  "button to enter the Settings of appointed hour/minute.
Press the "◀" and "▶" buttons to switch hour/minute;
Press the "▲" button to increment the appointed time, and press the "▼" button vice versa;
Press the  "button to save the settings and enter the week day settings of schedule cleaning.

Introduction of the virtual house

Introduction to the virtual house

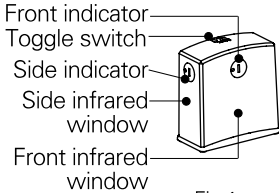

Fig.1

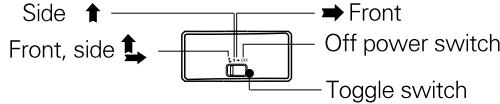









Fig.2

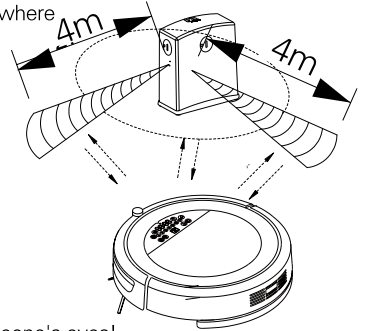

Fig.3

- Toggle “” to turn off the power for virtual house, switch among front, side, and front/side;
- Toggle “” to Off: the power of virtual house is cut off.
- Toggle “” to “” position: it indicates the power of the virtual house on, at this point of time, this is the front position, and the control radius of the virtual house is 4 m.
- Toggle “” to “” position: it indicates the power of the virtual house is on, at this point of time, this is the sidewise position, and the control radius of the virtual house is 4 m.
- Toggle “” to “” position: it indicates the power of the virtual house is on, at this point of time, this is the front/sidewise position, and the control radius of the virtual house is 4 m.

Instructions for the virtual house

1. Before use, remove the underside plate of the battery compartment of the virtual house, and place two D batteries according to the polarity indicated by the instructions into the compartment (Fig. 3). **Attention: Incorrect battery installation will render the virtual house out of order or damaged, and may lead to other accidents.**
2. The discharging length of the battery depending on the emission direction, distance and time of use. To make thrifty use of the battery, please select appropriate emission direction and distance to reduce the transmission power; and when the virtual house is not in use, please turn off the power.
3. Typically, place the virtual at staircase or doorway, or somewhere calling for the virtual house.
4. When using the virtual house, make ensure the virtual house and the vacuum cleaner are placed on the same plane, and that there is no obstruction in front of the virtual house as practical as possible, so as not to affect the barrier effect (Fig. 4).
5. In actual use, the emission distance of the virtual house will be depending on environment, the movement of the main unit and battery level.
6. When installing it, keep the virtual house 50cm or more from the cleaner, or there will be interference.
7. Before use, do not point the infrared emission head at someone's eyes!



Installation & removal and cleaning of the dust bin

1. Installation & removal of the dust bin of the cleaner

01. Press "PUSH" on the panel to pop out the dust cover (Fig. 1).
02. Take out the dust bin (Fig. 2).

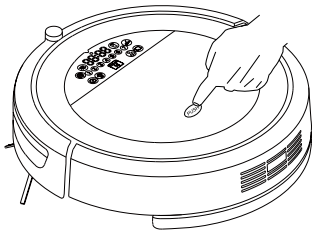

Fig.1

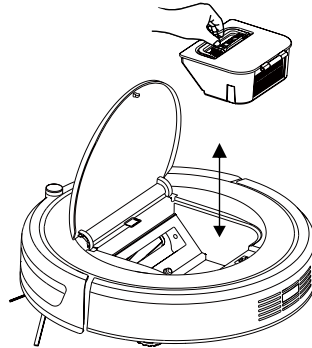

Fig.2

2. Cleaning of the dust bin

01. Open the upper cover of the dust bin, pour out the dirt and other junk (Figs. 3,4, and 5).
02. The dust bin and the filter screen can be rinsed with water (Fig. 6).

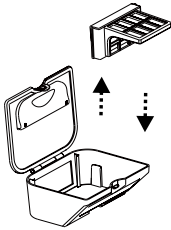

Fig.3

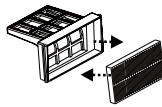

Fig.4

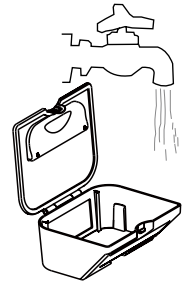

Fig.5



Attention

1. After rinsing, dry the dust bin, filter and HEPA before replacing them (with cool air from an electric hair drier).
2. Please strictly follow the instructions when removing and installing the dust bin.
3. Water tank can not wash!

Installation of the intelligeng water tank/ trailing bar/ mop

1. Installation of the trailing bar/ mop:

1. Install the mop onto the position where it is to be adhered.
2. As shown in Fig. 1, mount the trailing bar onto the unit by aligning it with holes.

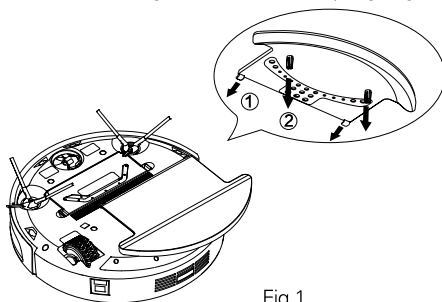

Fig.1

2. Installation of the intelligent programmable tank:

1. As shown in Fig. 2, mount the small dust bin onto the water tank first before use.
2. As shown in Fig. 3, take out the water tank, open the flexible plastic inlet, inject clear water, and replace the inlet lid.
3. As shown in Fig. 4, place the water tank into the cleaner, replace the cover and the unit is ready to mop.

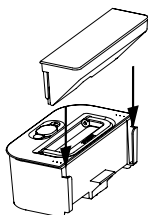

Fig.2

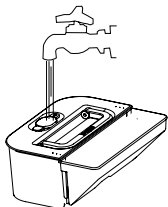

Fig.3

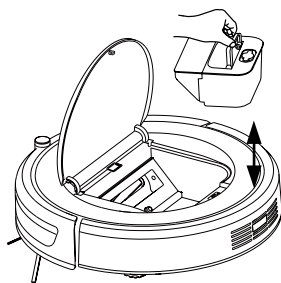

Fig.4



Attention

1. Before injecting water into the water tank, take the tank out rather than directly replenishing the water tank lest any water go into the unit and lead to short circuit.
2. When using the water tank, it is prohibited to turn over the unit, lest water get into the machine and cause damage.
3. After the water tank is refilled, clean it if there is water around the water tank.
4. The cleaner will display error code E012 if the water tank runs out of water (see page 8 for more).

Common Failures and Troubleshooting



Attention

The cleaner will sound the alarm when it stops working or fails to start working in the following circumstances; users may follow the prompts to respond accordingly.

| Failure Code | Cause | Failure Identification | Troubleshooting |
|--------------|--|---|--|
| E001 | Failure of ground detection | The sensor head is blocked or the cleaner is stuck in stairs | Clean the cliff sensor ground detector or manually pick up the cleaner |
| E002 | The suction inlet is blocked | The dust sensor head is covered with dust or the passage is blocked | Clean the foreign objects off the dust sensor head and the suction inlet |
| E003 | The left and right wheels fail to work | The left and right drive wheels are entangled with wires | Clean the foreign objects on the left and right wheels to resume operation |
| E004 | Failure of side brushes | The left or right side brushes are entangled with wires | Clean the foreign objects on the left or right side brushes to resume operation |
| E005 | The left and right wheels are off the ground | The drive wheels are in the air | Place the cleaner back onto a flat ground to resume operation |
| E006 | not in use | not in use | not in use |
| E007 | Low battery | The cleaner won't work properly | Manually move the cleaner back to the docking station recharging |
| E008 | The cleaner won't be recharged | The power switch of the cleaner is not turned on or the battery is not connected in place | Turn the power switch of the cleaner to ON or properly place the battery in place |
| E009 | Wall detection failure | The sensor head for wall detection is blocked | Clean the transparent front collision member of the cleaner to resume operation |
| E010 | Front bumper | The switch and the front bumper blocked | Push heavily the front bumper, then check whether the front bumper can bounce back |
| E011 | Battery NTC | Check if the battery is properly installed | Unplug the battery terminals or replace the battery |
| E012 | Low level of the water tank | Check whether there is water in the water tank | Take out the water tank and fill it with water |



Remark

If failure persists after troubleshooting instructed above, please contact our after-sale service department.

Dimensions and Parameters

Technical specification for the cleaner

| No. | Item | Index parameter | Remark |
|-----|-------------------------------|---------------------|--------|
| 1 | Model | X1000 | |
| 2 | Rated voltage | DC 14.8V | |
| 3 | Rated power | 30W | |
| 4 | Operating temperature range | -10°C ~45°C | |
| 5 | Input voltage/current | DC 24V/0.5A | |
| 6 | Infrared remote control | 38KHZ | |
| 7 | Dimension | Φ 350mmX87.5mm | |
| 8 | Weight | 2.9KG | |
| 9 | Battery | Lithium-ion 2200mAh | |
| 10 | Dust bin capacity | 900ml | |
| 11 | Small dust bin and water tank | 250ml+600ml | |

Technical specification for the charging dock station

| No. | Item | Index parameter | Remark |
|-----|-----------------------------|--------------------------|--------|
| 1 | Applicable model | X1000 | |
| 2 | Dimension | L × W × H: 194X15X105 mm | |
| 3 | Input voltage/current | DC 24V/0.5A | |
| 4 | Operating temperature range | -10°C ~45°C | |
| 5 | Operating humidity range | ≤ 85RH | |

Technical specification for the remote controller

| No. | Item | Index parameter | Remark |
|-----|---------------------------------|-------------------------|--------|
| 1 | Applicable model | X1000 | |
| 2 | Dimension | L × W × H: 146X45X15 mm | |
| 3 | Battery | DC 3V(AAA) | |
| 4 | Remote control method | Infrared | |
| 5 | Emitting and receiving distance | ≤ 5M | |
| 6 | Operating temperature range | -10°C ~45°C | |
| 7 | Operating humidity range | ≤ 85RH | |

Technical specification for the virtual house

| No. | Item | Index parameter | Remark |
|-----|-----------------------------|----------------------|--------|
| 1 | Applicable model | X1000 | |
| 2 | Dimension | L × W × H: 78X64X105 | |
| 3 | Battery | DC 3V(A) | |
| 4 | Emission method | Infrared | |
| 5 | Emitting distance | ≤ 4m | |
| 6 | Operating temperature range | -10°C ~45°C | |
| 7 | range | ≤ 85RH | |