

**NOTHING
SHOULD COME BETWEEN
A MAN
AND HIS FLAME.**

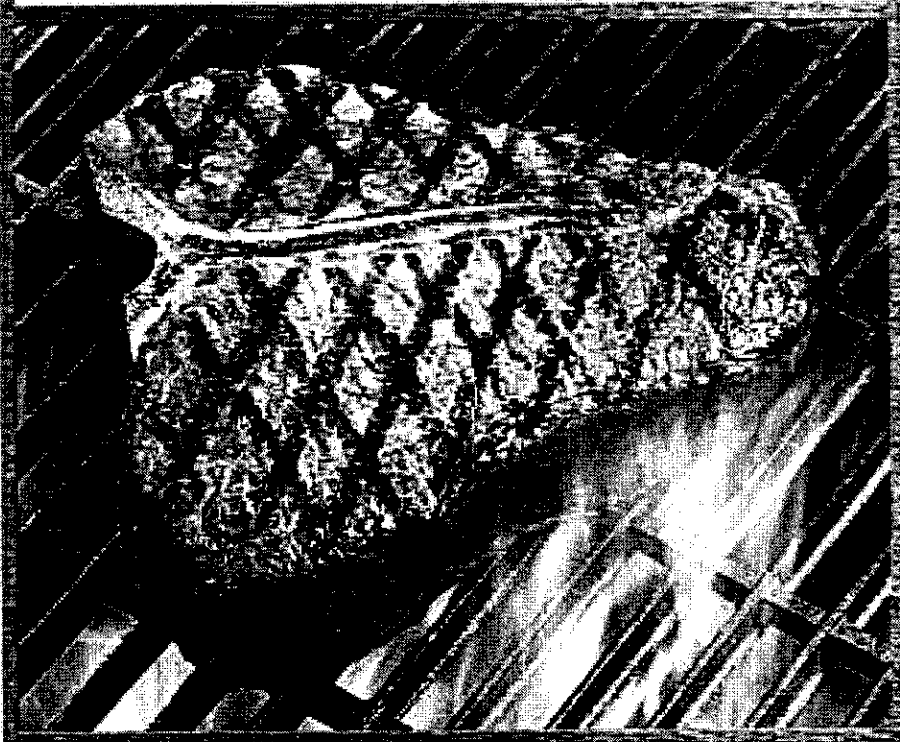

463645004 / 0-4165356 (10-01-03)

QUICKSET[®]

463645004
ASSEMBLY MANUAL



**THIS GRILL IS FOR
OUTDOOR USE ONLY**

CAUTION: Read and follow all safety statements, assembly instructions, and use and care directions before attempting to assemble and cook.

INSTALLER/ASSEMBLER: Leave these instructions with consumer.

CONSUMER: Keep this manual for future reference.

▲ WARNING

Failure to follow all manufacturer's instructions could result in serious personal injury and/or property damage.

▲ CAUTION

Some parts may contain sharp edges – especially as noted in the manual! Wear protective gloves if necessary.

If you have any questions or need assistance during assembly, please call 1-800-241-7548.

Visit us on the web at:
www.charbroil.com

Char-Broil

KEEPERS OF THE FLAME
COLUMBUS, GA

1

Parts to assemble:

- 2 Leg Assembly
- 1 Front Panel
- 1 Side Support Brace
- 4 Carriage Bolt, 2"
- 4 Plastic Tee Knob

- A. Lay leg assemblies on their sides.
- B. Place front panel on legs.
- C. Brace attaches to inside of left legs.
- D. Secure with carriage bolts and tee knobs.

NOTE: Leave tee knobs loose on right side.

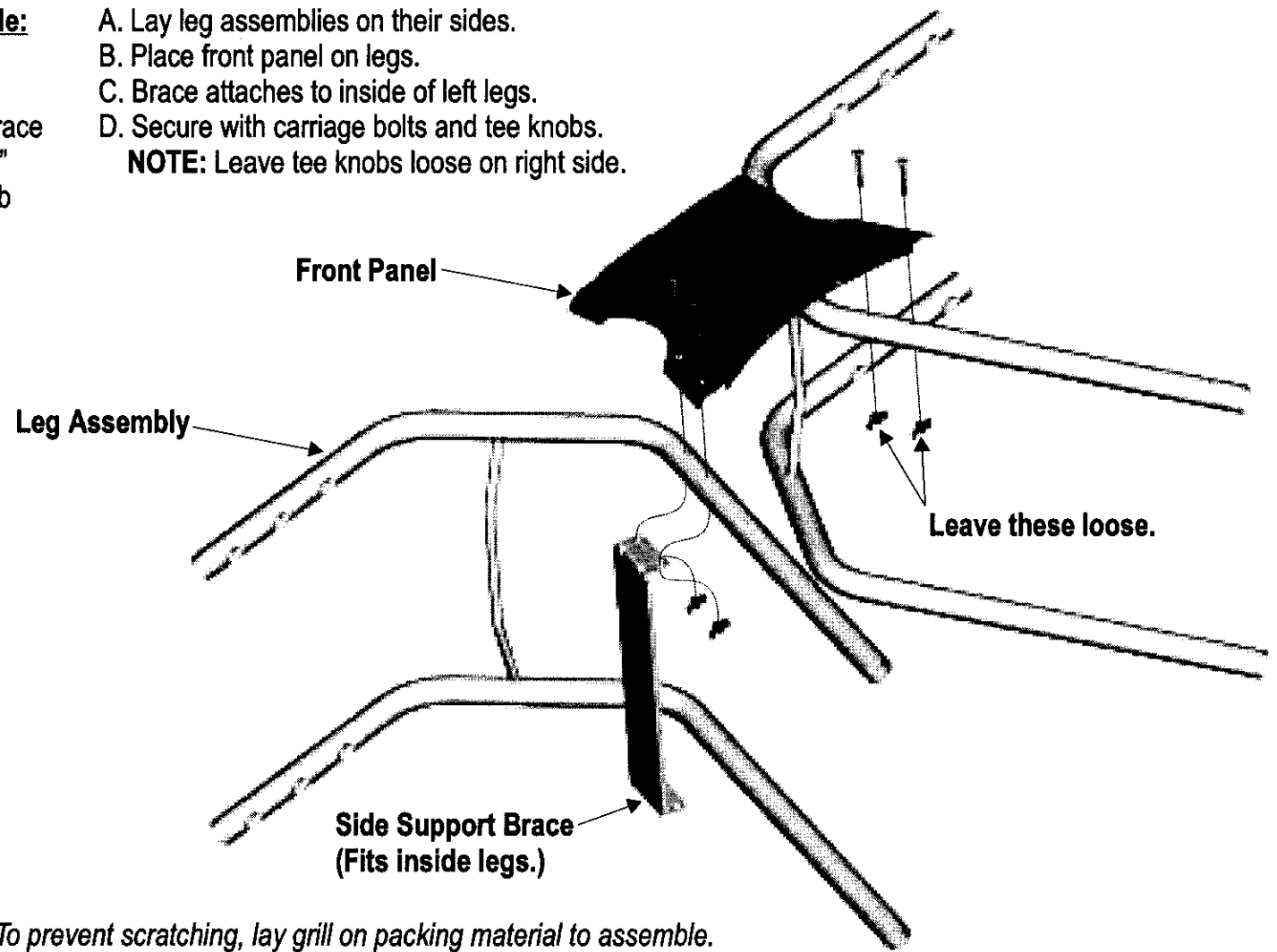
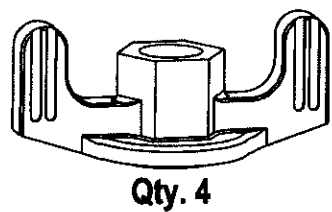
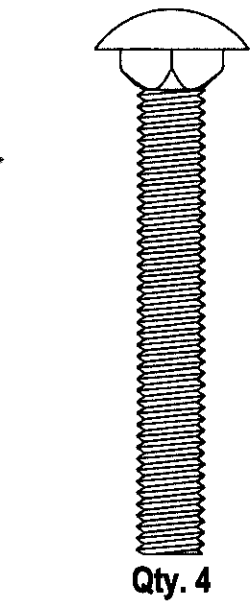

NOTE: To prevent scratching, lay grill on packing material to assemble.

2

Parts to assemble:

- 1 Back Support Brace
- 4 Carriage Bolt, 2"
- 4 Plastic Tee Knob
- 2 Axle Bolt
- 2 Wheel
- 1 Tank Support Bracket
- 2 Hitch Pin
- 2 Leg Extender

- A. Turn assembly upside-down.
- B. Secure back brace and side brace to left leg and back brace to right leg with carriage bolts and tee knobs. **NOTE:** Leave tee knobs loose on right side.
- C. Insert axle bolts through wheels, legs and bracket. Bracket fits inside legs. Secure with hitch pin.
- D. Push leg extenders into right legs.

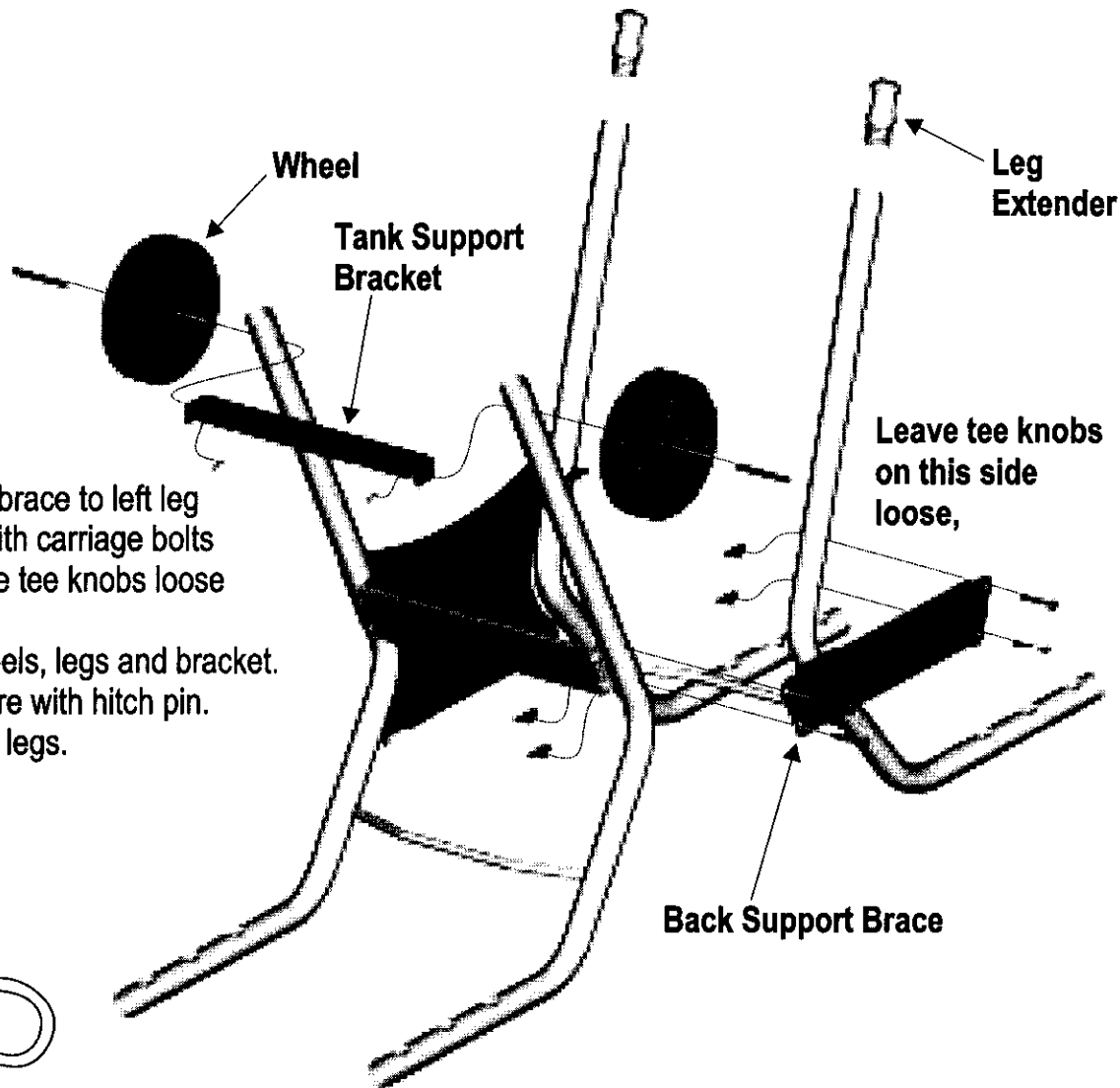
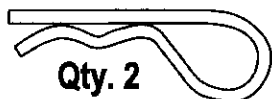
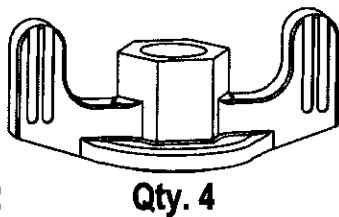
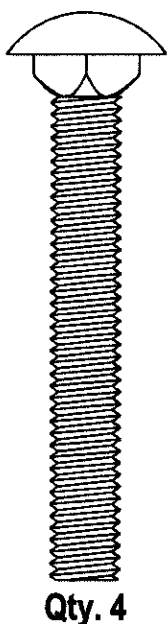
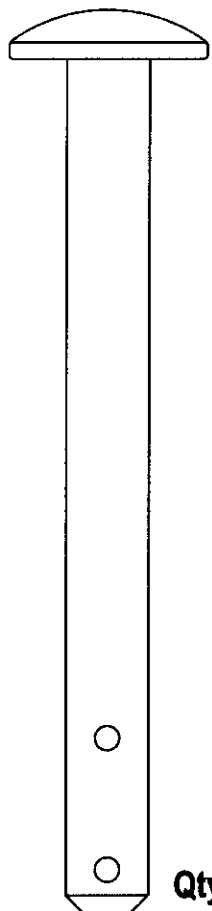

3

Parts to assemble:

1 Condiment Basket

- A. Stand cart upright.
- B. Place condiment basket hooks over front panel bolts on inside of front leg. See inset **A**.
- C.. Place condiment basket hooks over back support brace bolts on outside of brace. See inset **B**.
- D.. Fully tighten tee knobs on both legs.

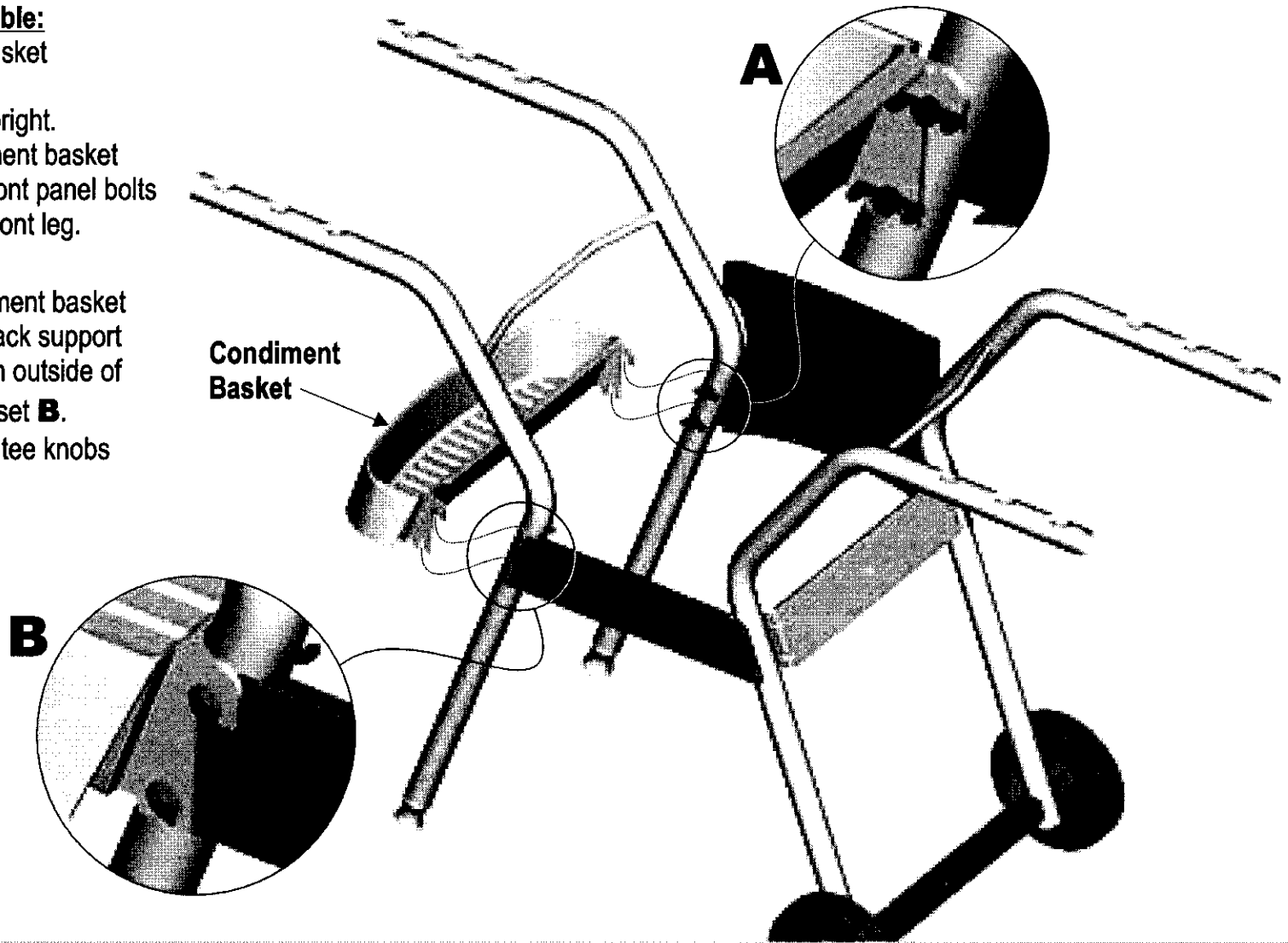

4

Parts to assemble:

- 1 Grill Bottom Assembly
- 4 Carriage Bolt, 1 1/4"
- 4 Metal Wing Nut
- 2 Control Knob

- A. Make sure ignitor wire is connected to ignitor.
- B. Place grill bottom onto supports. Control panel overlaps front panel.
- C. Secure with carriage bolts and wing nuts.
- D. Press control knobs onto valves.

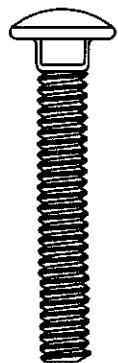

Qty. 4

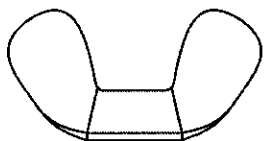

Qty. 4

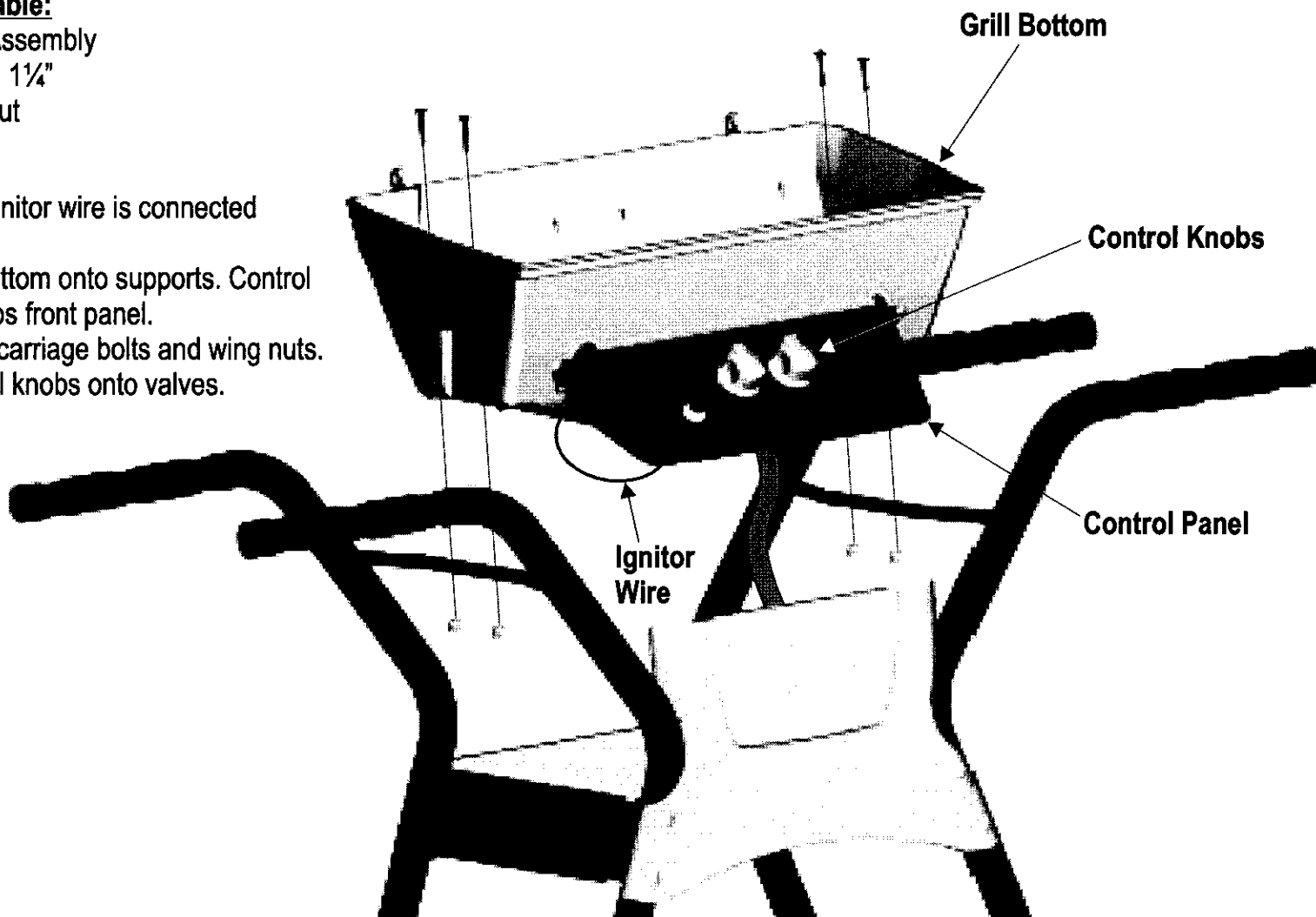

5

Parts to assemble:

- 1 Vaporiser Bar
- 1 Cooking Grate

- A. Place vaporiser bar onto the two inner support ridges at each end of grill bottom. Bar should rest between the outer support ridges. See inset below.
- B. Place cooking grate onto grill bottom.

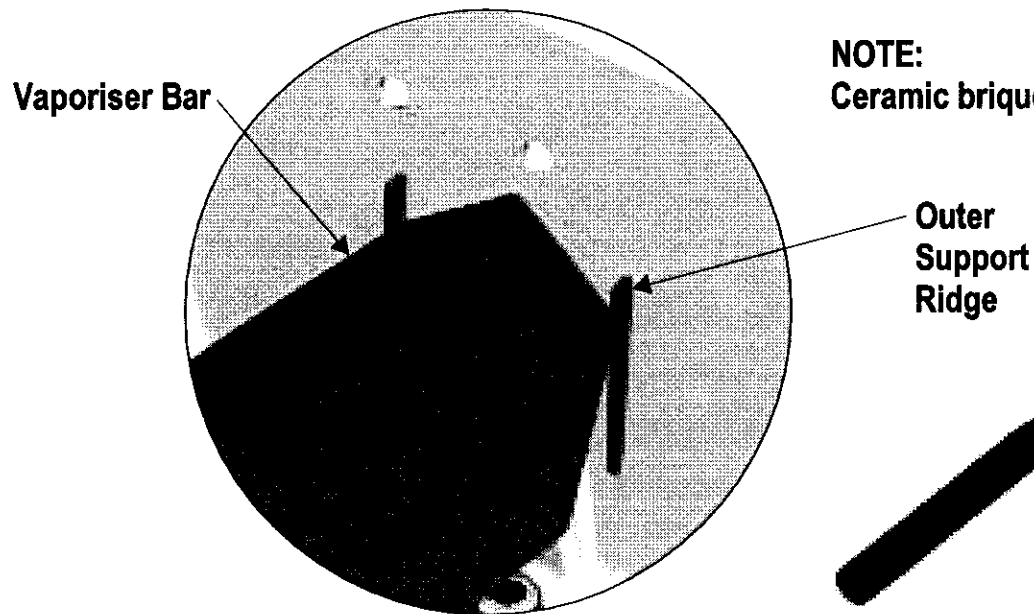

NOTE:
Ceramic briquets are not required.

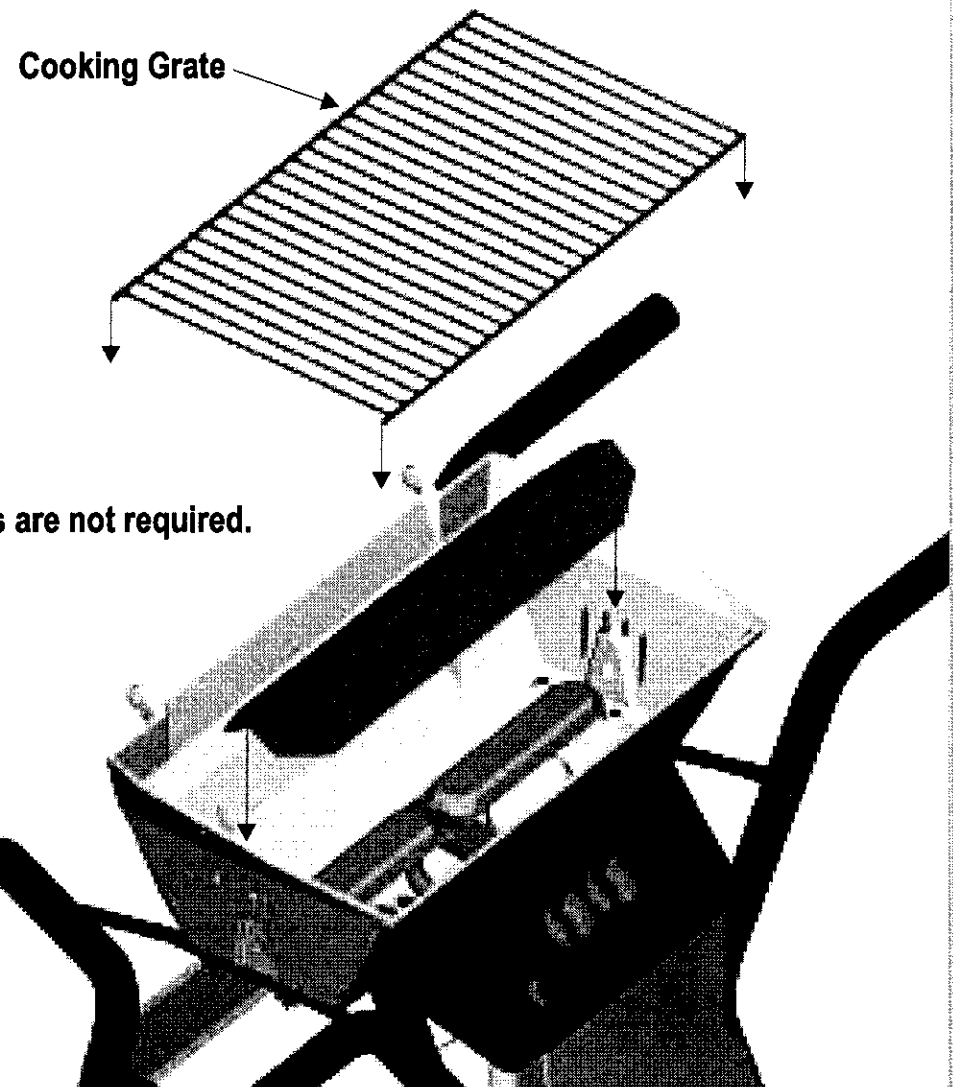

6

Parts to assemble:

2 Side Shelf

8 Carriage Bolt, 2"

8 Crown Fasteners
or Plastic T Knobs

- A. Place shelves onto legs (curved edge inward).
- B. Secure with carriage bolts and crown fasteners or T knobs.

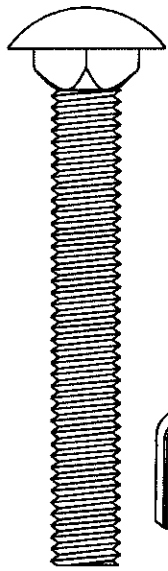

Qty. 8

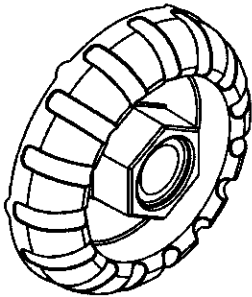

Qty. 8

-OR-

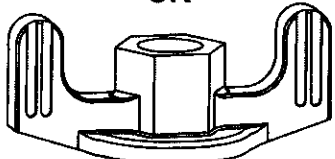

Qty. 8

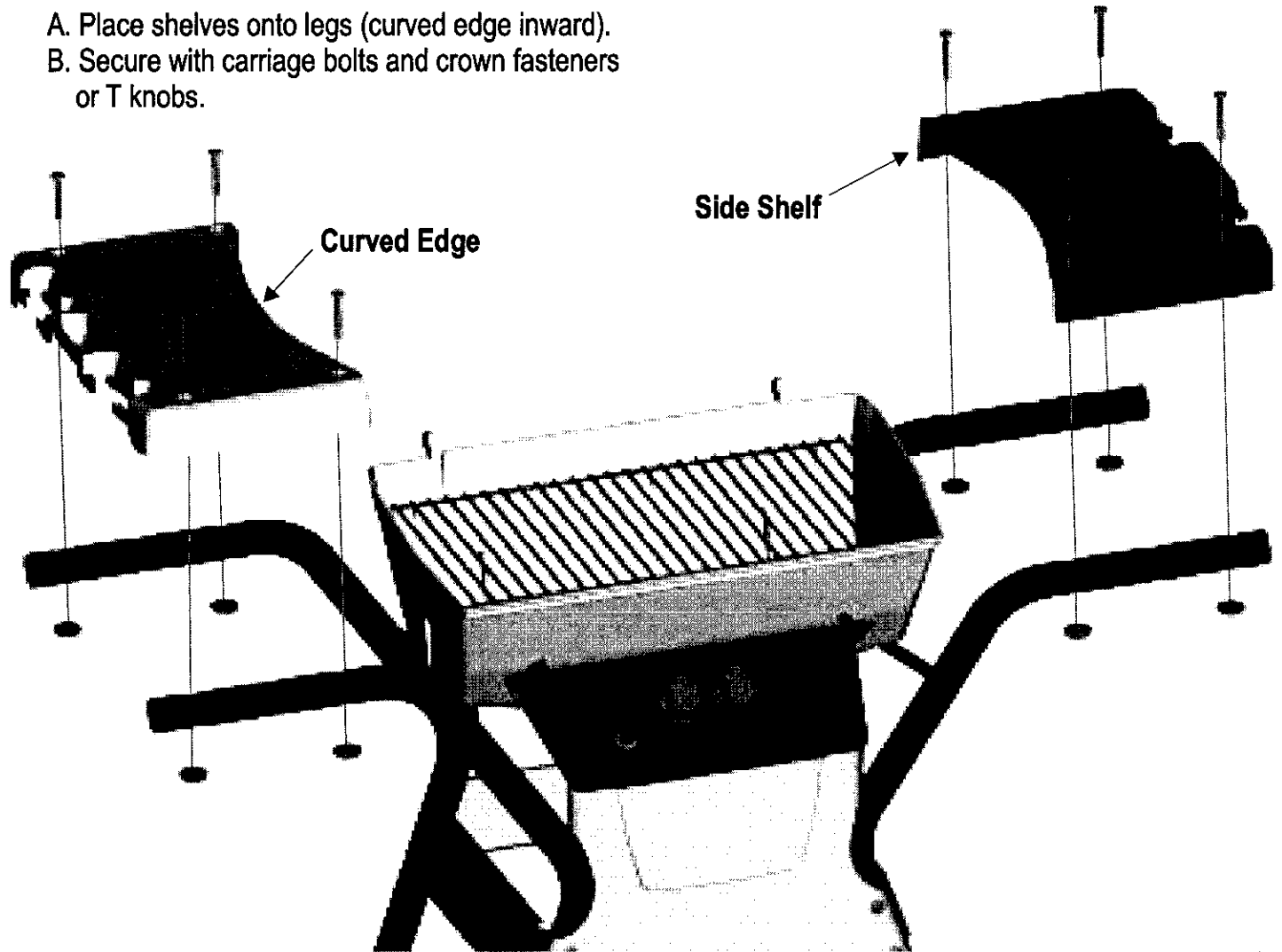

7

Parts to assemble:

- 1 Grill Lid
- 1 Handle
- 1 Machine Screw, 1 $\frac{3}{4}$ "
- 1 Metal Wing Nut
- 2 Hinge Pin
- 2 Hitch Pin
- 1 Logo Plate

- A. Attach lid to grill bottom with hinge and hitch pins.
- B. Attach handle to lid with machine screw and metal wing nut.
- C. Snap logo plate into grill lid.

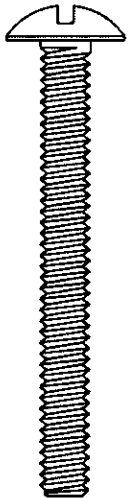

Qty. 1

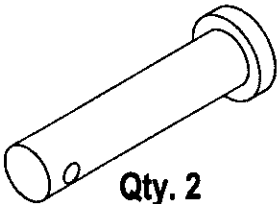

Qty. 2

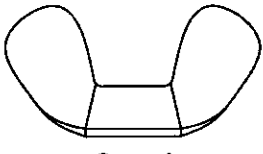

Qty. 1

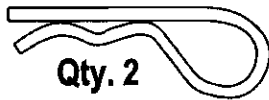

Qty. 2

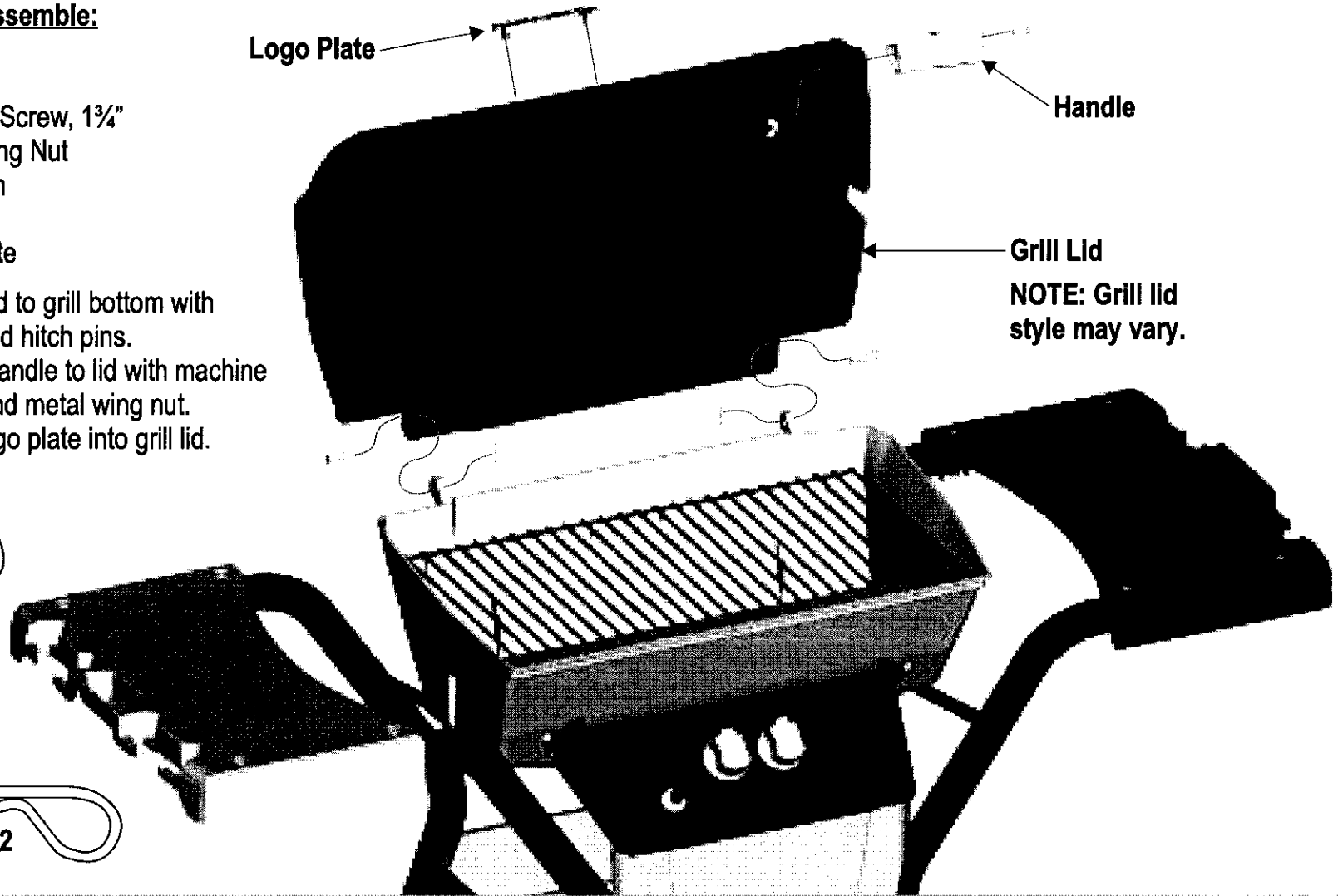

Logo Plate

Handle

Grill Lid

NOTE: Grill lid style may vary.

8

Parts to assemble:

1 SwingAway

- A. Slide rear pivot wire of SwingAway into holes in grill lid.
- B. Insert leg wires into top hole of three-hole pattern in side of grill bottom.

NOTE: Grill lid style may vary.

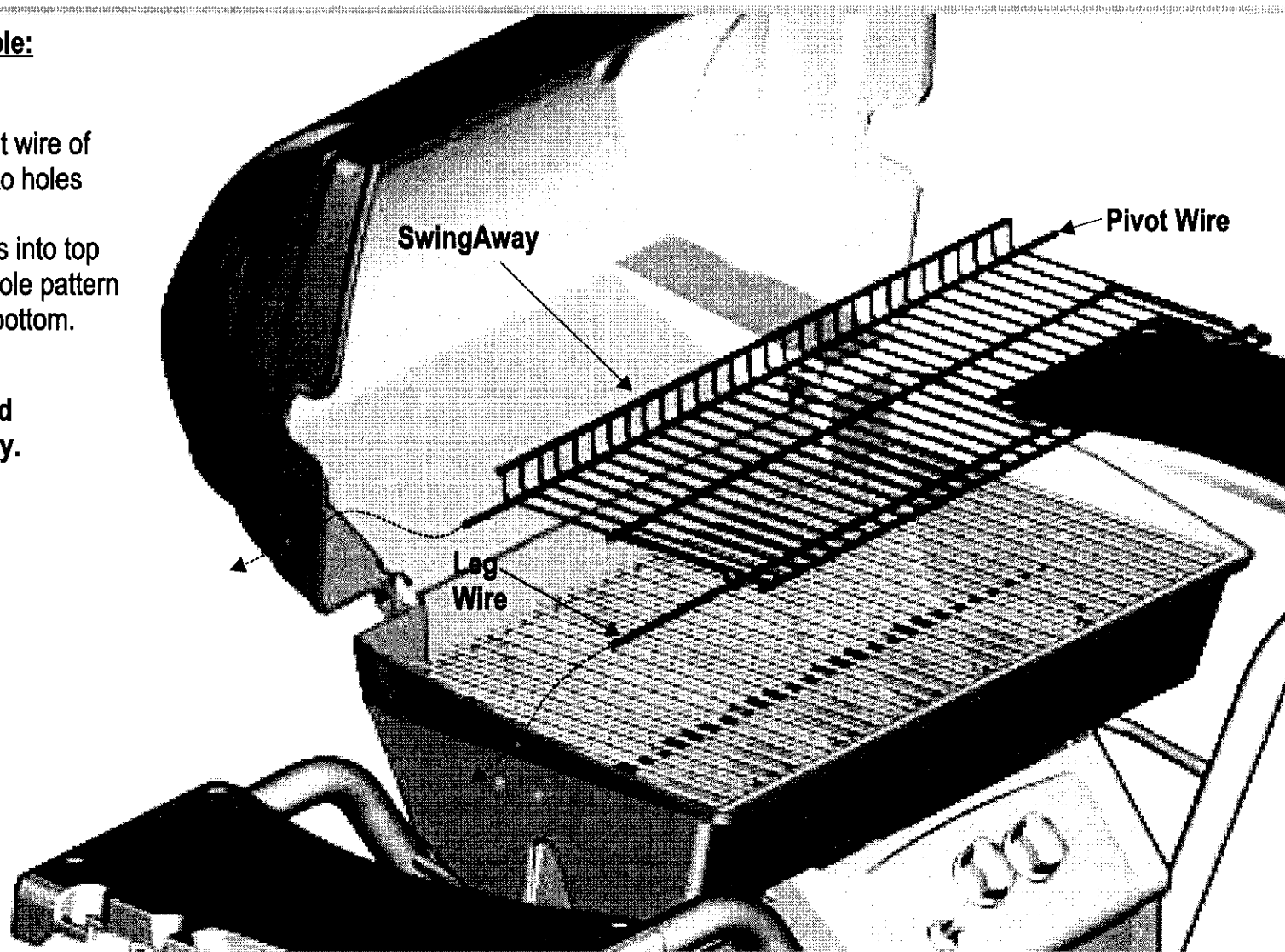

9

Parts to assemble:

- 1 Tank Retainer Wire
- 1 Carriage Bolt, 1 1/4"
- 1 Plastic Tee Knob

A. Attach retainer wire to left side brace with carriage bolt and tee knob. Leave loose.

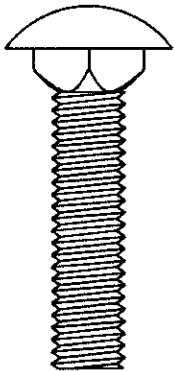

Qty. 1

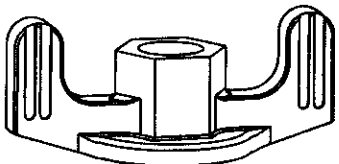

Qty. 1

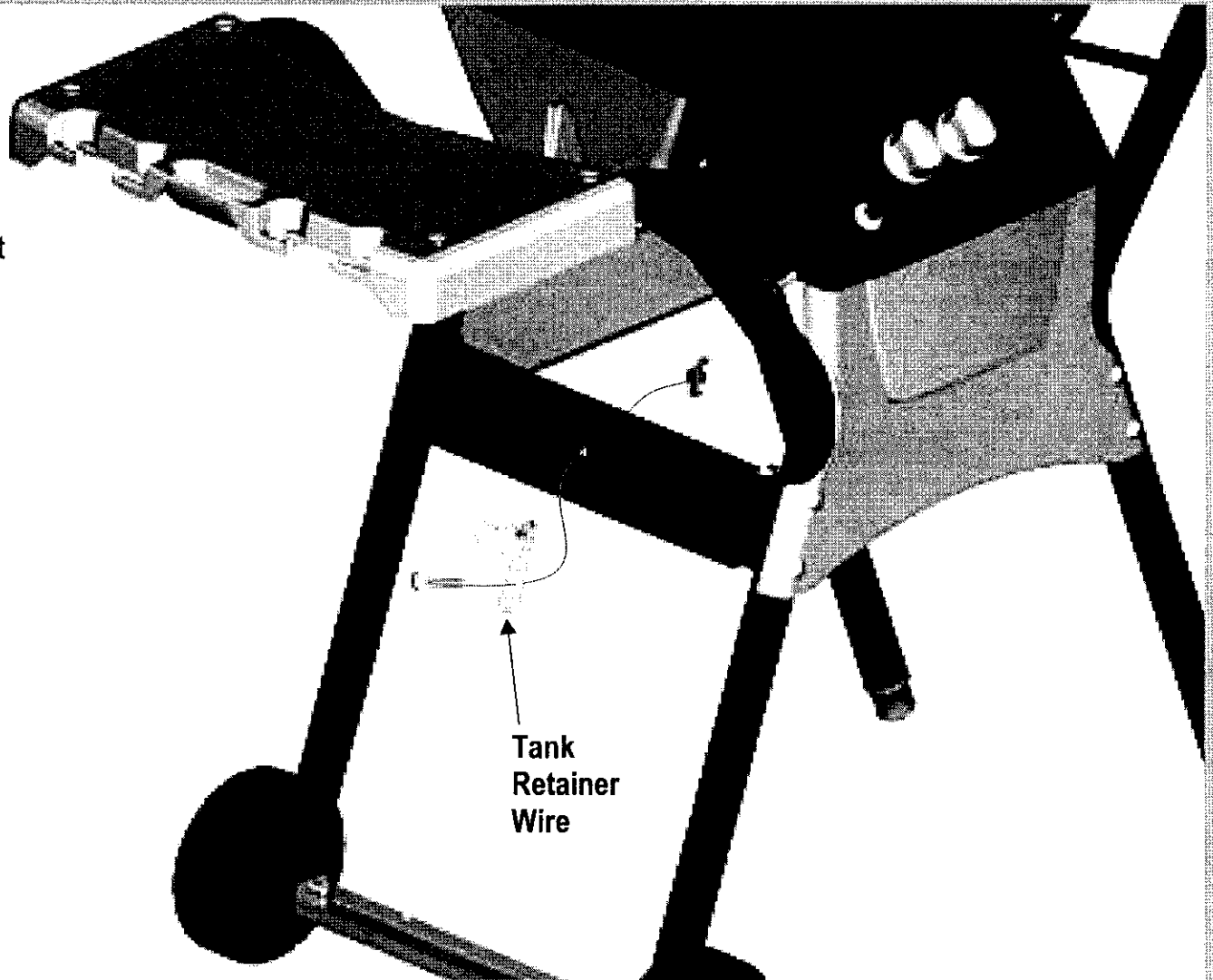

Tank
Retainer
Wire

10

Parts to assemble:

1 LP Gas Tank
(not included)

LP tank is sold separately. Fill and leak check before attaching to grill and regulator.

- A. Center LP tank on support bracket with collar opening to front.
- B. Slide retainer over tank collar and tighten tee knob.



Tank collar opening must face to front of cart once tank is attached.

Failure to install tank correctly may allow gas hose to be damaged in operation, resulting in the risk of fire.

See Use & Care manual to perform the “Burner Flame Check” and for important safety instructions before using.

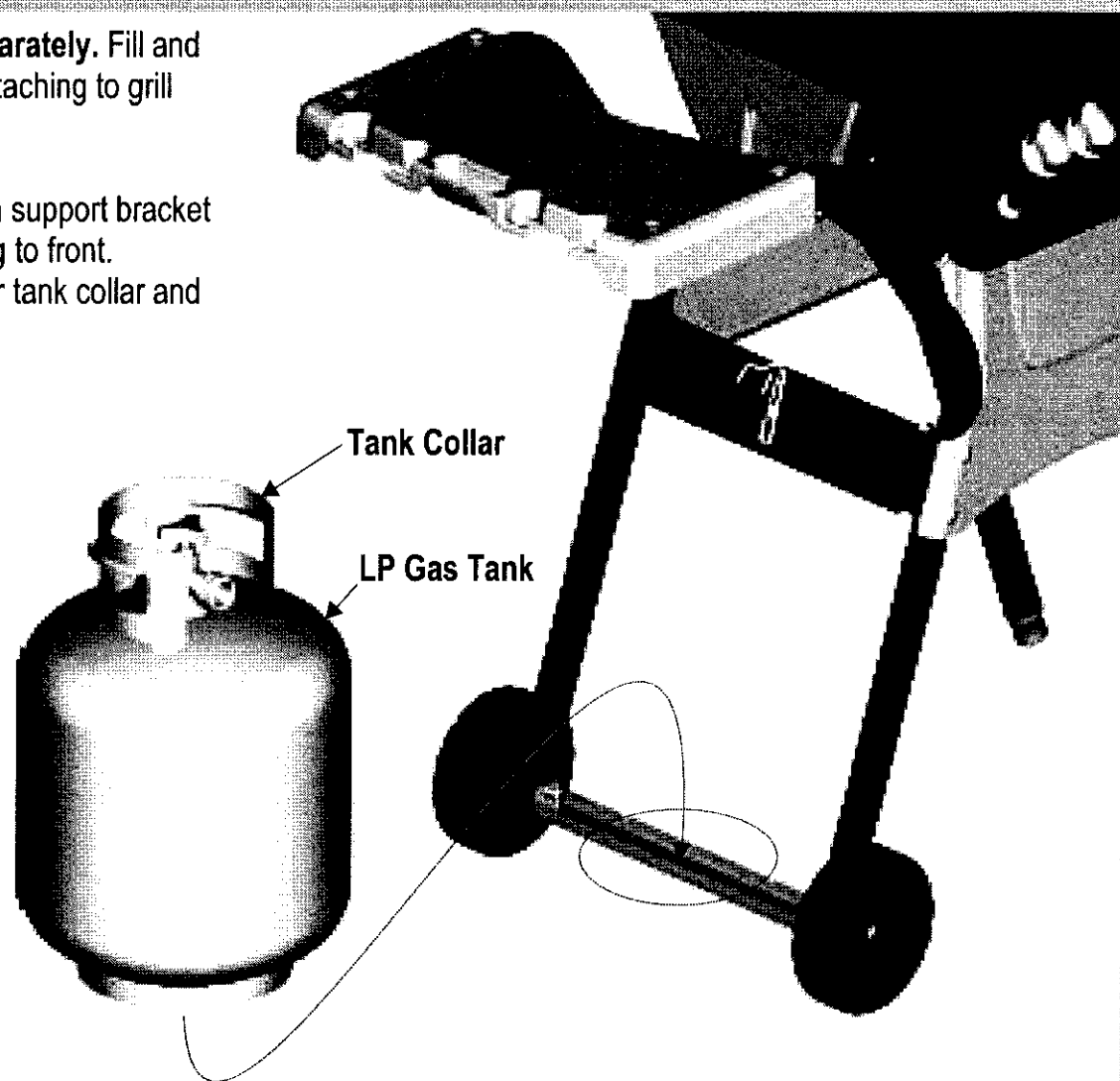

11

Parts to assemble:

1 Grease Clip

- A. Hang grease clip beneath grill bottom.
- B. Hang an empty soup can (not included) from grease clip.



• Failure to install can in clip will cause hot grease to drip from bottom of grill with risk of fire or property damage.

Rear view
of grill.

