

# Z313 SPEAKER SYSTEM WITH SUBWOOFER

## SYSTÈME DE HAUT-PARLEURS Z313

### AVEC CAISSON DE BASSES

Complete Setup Guide  
Guide d'installation complet

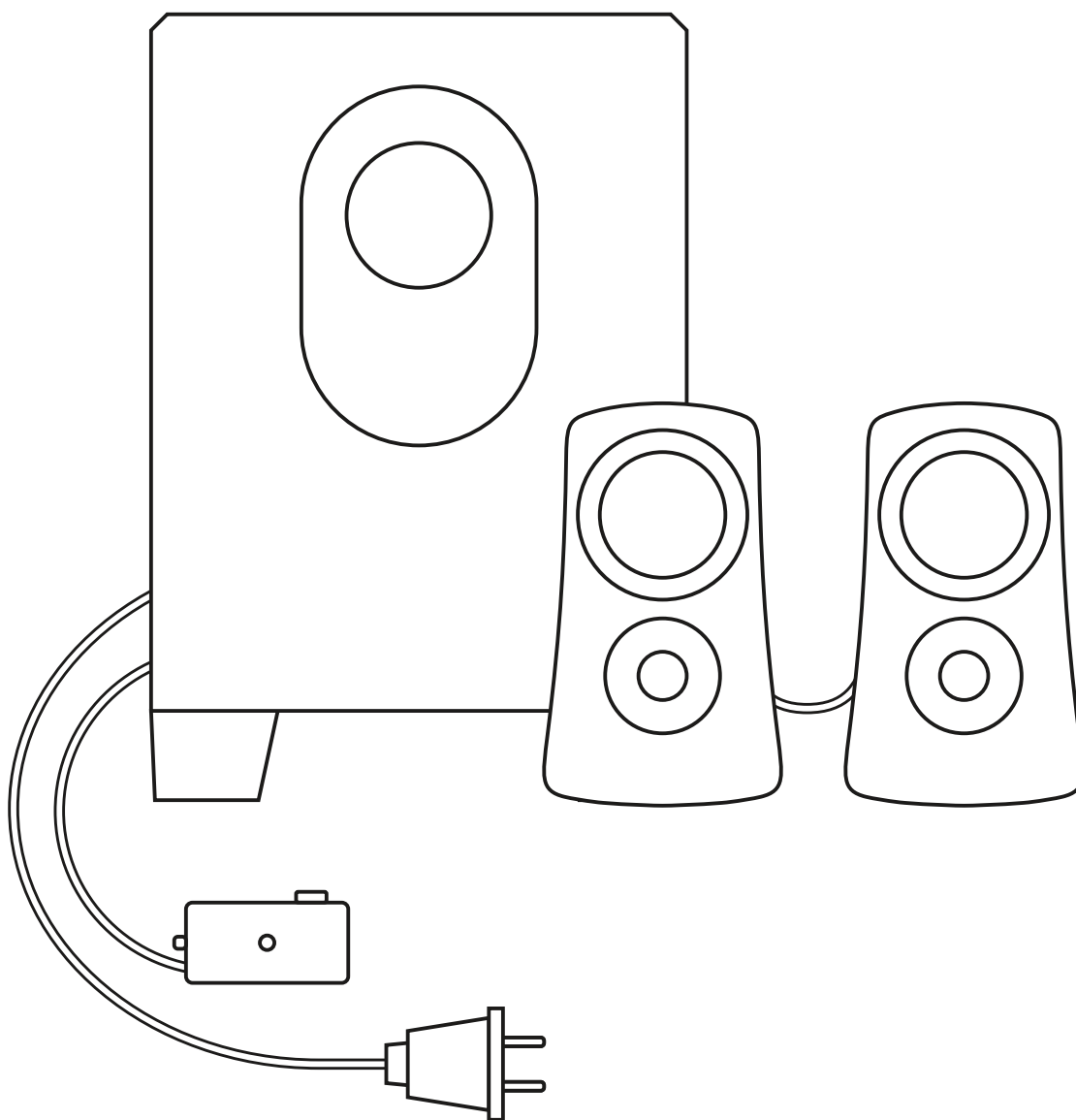

logitech®

## CONTENTS

English . . . . .3

Français . . . . .6

Español . . . . .9

Português . . . . .12

KNOW YOUR PRODUCT

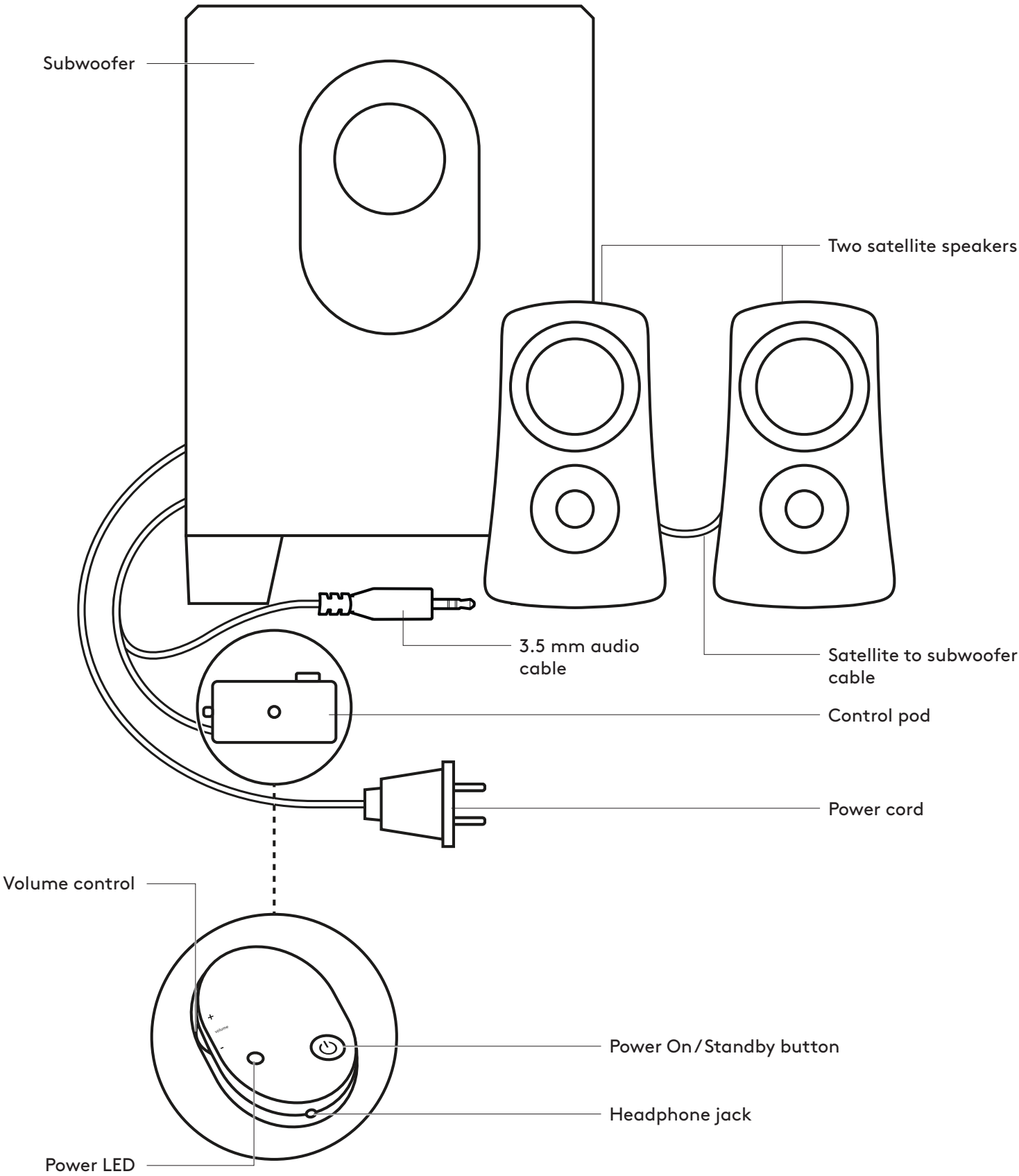

## CONNECT THE SPEAKERS

1. Plug satellites cable into the subwoofer jack.
2. Plug the power plug into an electrical outlet.
3. Insert the 3.5mm connector from the control pad into the audio jack on your device (e.g. computer).
4. Press the power button on the control pad to turn the speakers on.

1

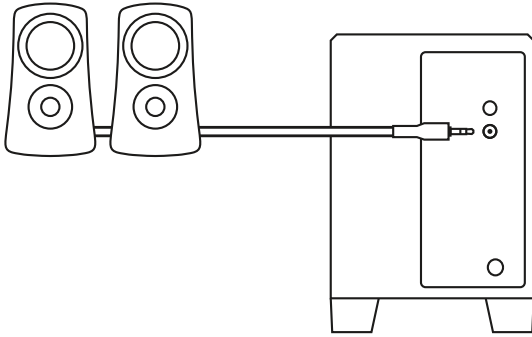

2

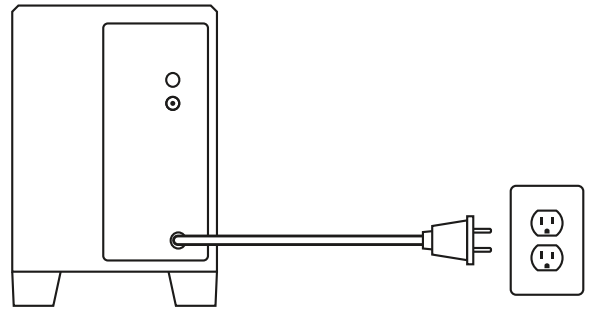

3

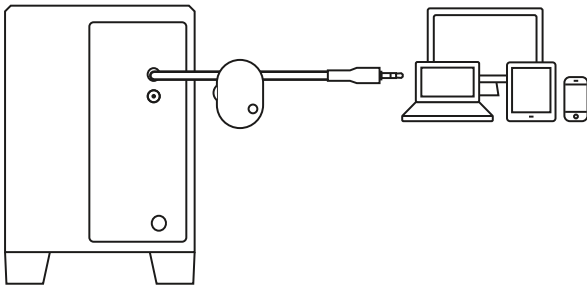

4

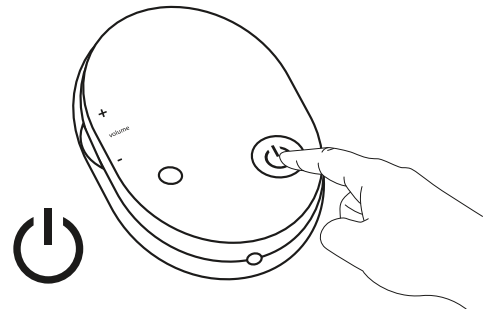

## CONNECT YOUR HEADPHONES

To use headphones with your Z313 speakers, plug them into the headphone jack on the control pod.

To change the volume of your headphones, adjust the volume from your audio input source.

NOTE: The volume control on the control pod does not control the headphone volume

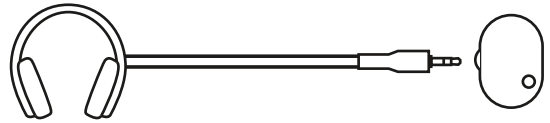

## ADJUST THE VOLUME

Increase (or decrease) the speakers volume by rolling up (or down) the wheel located on the left side of the control pod.

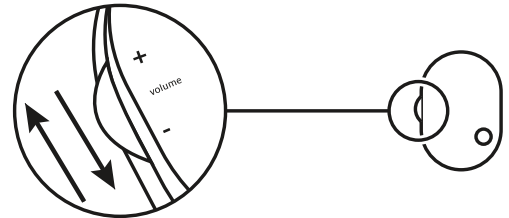

[www.logitech.com/support/Z313](http://www.logitech.com/support/Z313)

# PRÉSENTATION DU PRODUIT

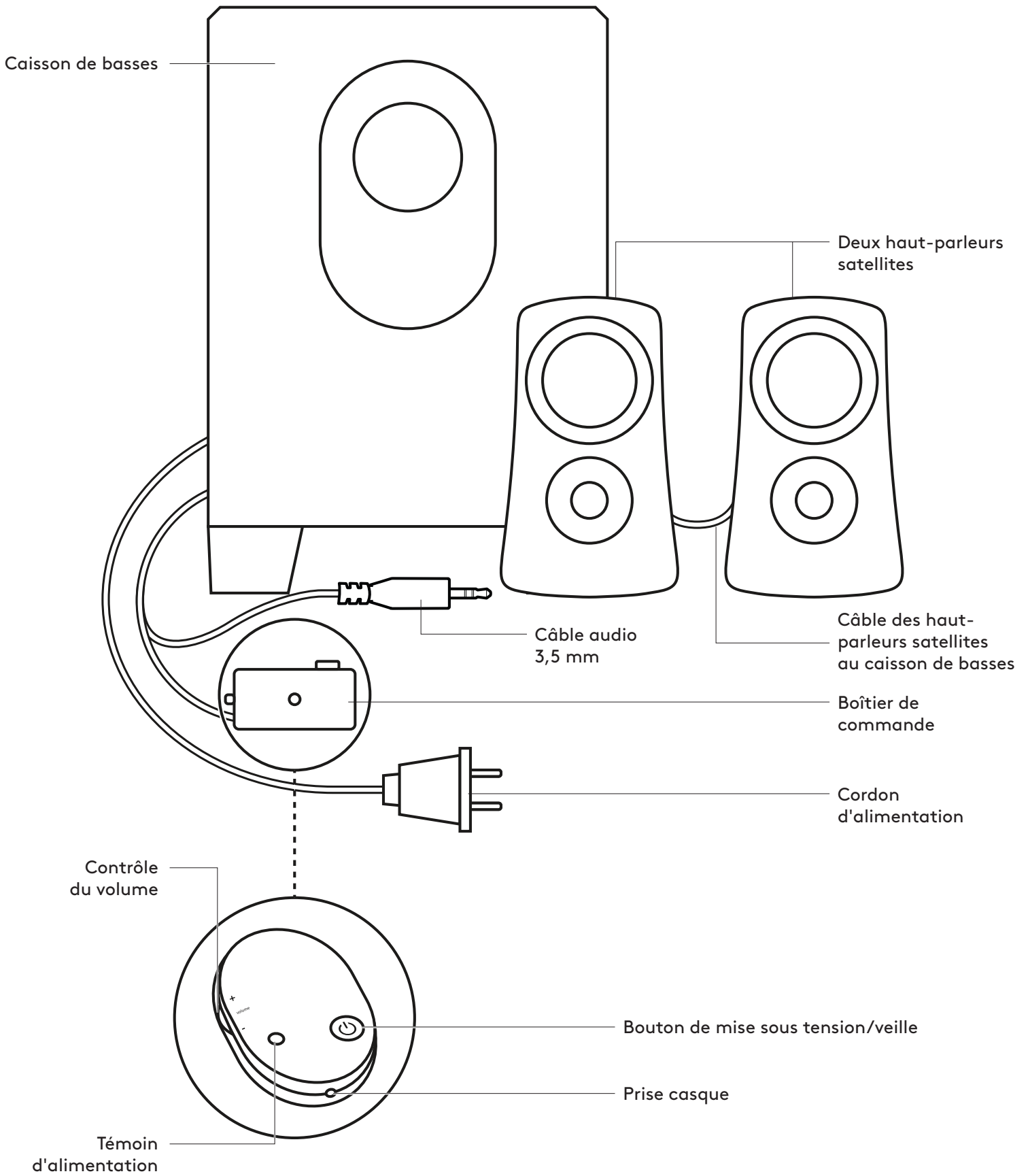

## CONNEXION DES HAUT-PARLEURS

1. Branchez le câble des haut-parleurs satellites sur la prise du caisson de basses.
2. Branchez l'adaptateur secteur à une prise électrique.
3. Branchez le connecteur 3,5mm du boîtier de commande à la prise audio de votre dispositif (par exemple, un ordinateur).
4. Appuyez sur le bouton d'alimentation du boîtier de commande pour mettre les haut-parleurs sous tension.

1

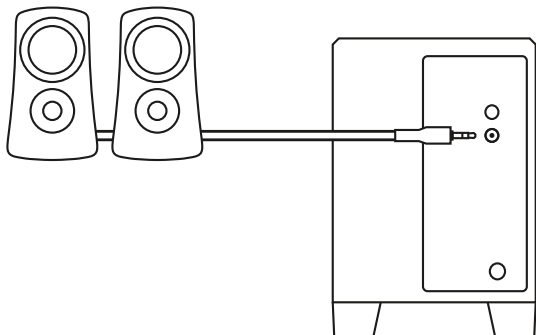

2

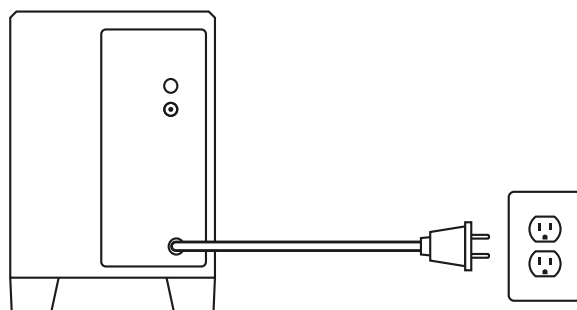

3

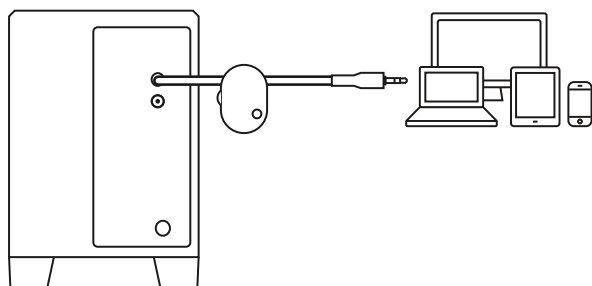

4

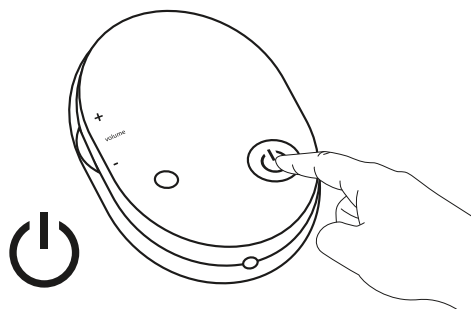

## CONNEXION DE VOS ÉCOUTEURS

Si vous souhaitez utiliser des écouteurs avec votre système de haut-parleurs Z313, branchez-les sur la prise casque située sur le boîtier de commande.

Vous devez régler le volume de vos écouteurs à partir de la source d'entrée audio.

REMARQUE: la commande de volume du boîtier de commande ne contrôle pas le volume des écouteurs.

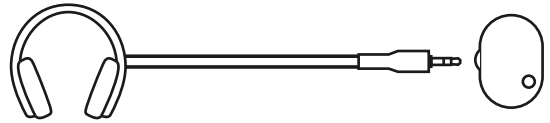

## AJUSTEMENT DU VOLUME

Augmentez (ou diminuez) le volume des haut-parleurs en tournant dans le sens horaire (ou antihoraire) la molette située sur le côté gauche du boîtier de commande.

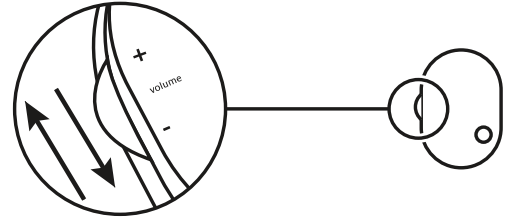

[www.logitech.com/support/Z313](http://www.logitech.com/support/Z313)

# COMPONENTES DEL PRODUCTO

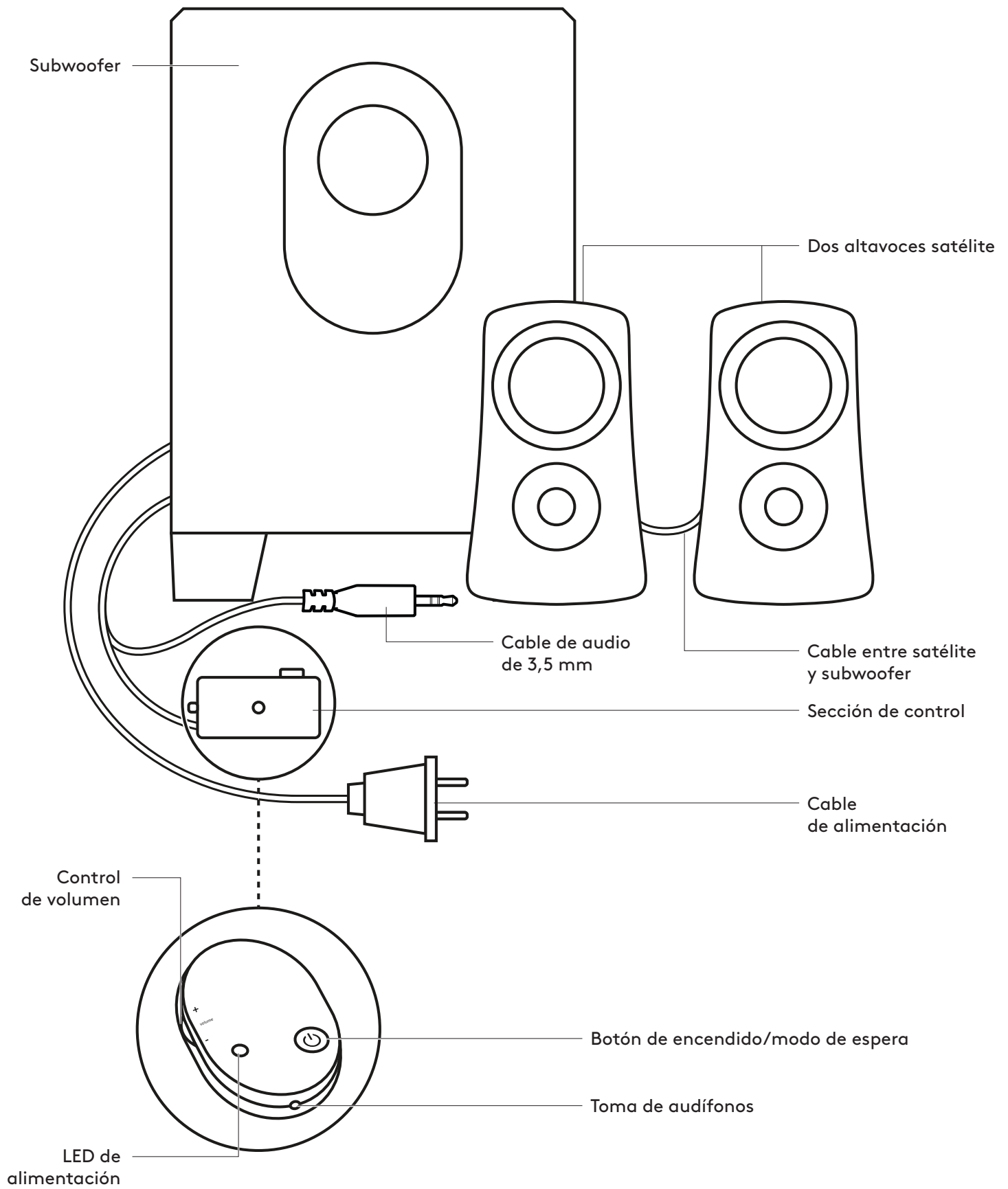

## CONECTA LOS ALTAVOCES

1. Conecta el cable de los altavoces satélite a la toma del subwoofer.
2. Conecta la clavija de alimentación a una toma de corriente.
3. Inserta el conector de 3,5 mm de la sección de control en la toma de audio del dispositivo (p. ej. una computadora).
4. Presiona el botón de encendido en la sección de control para encender los altavoces.

1

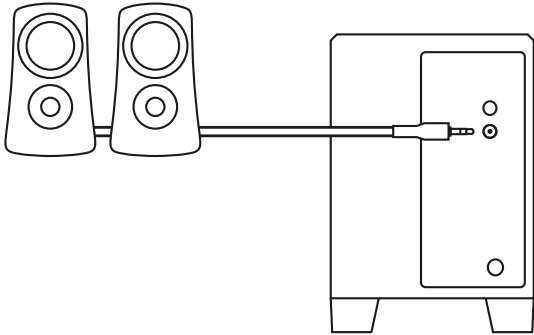

2

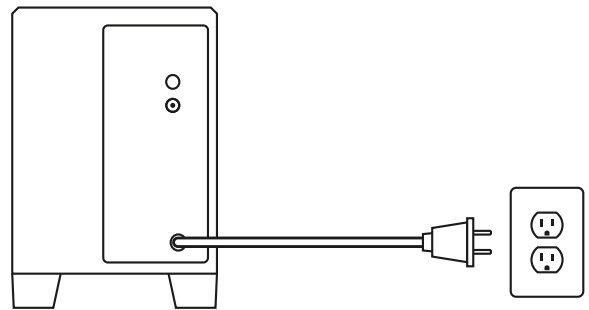

3

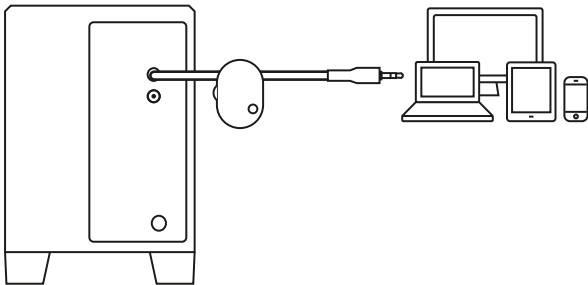

4

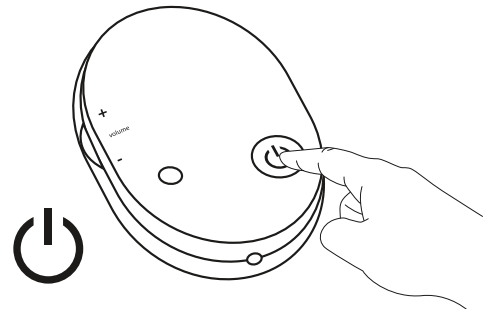

## CONECTA LOS AUDÍFONOS

Para usar audífonos con los altavoces Z313, conéctalos a la toma de audífonos de la sección de control.

Para cambiar el volumen de los audífonos, ajústalo en la fuente de entrada de audio.

NOTA: Ten en cuenta que el control de volumen en la sección de control no controla el volumen de los audífonos

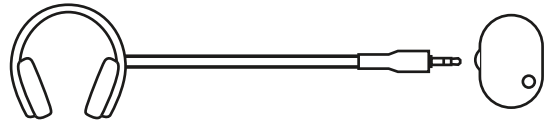

## AJUSTA EL VOLUMEN

Aumenta (o reduce) el volumen de los altavoces girando hacia arriba (o hacia abajo) la rueda ubicada en el lado izquierdo de la sección de control.

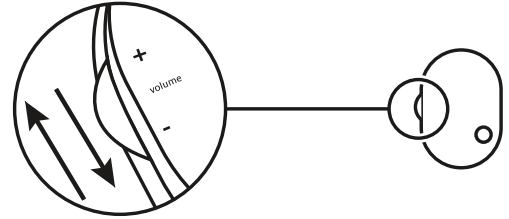

[www.logitech.com/support/Z313](http://www.logitech.com/support/Z313)

# CONHEÇA O SEU PRODUTO

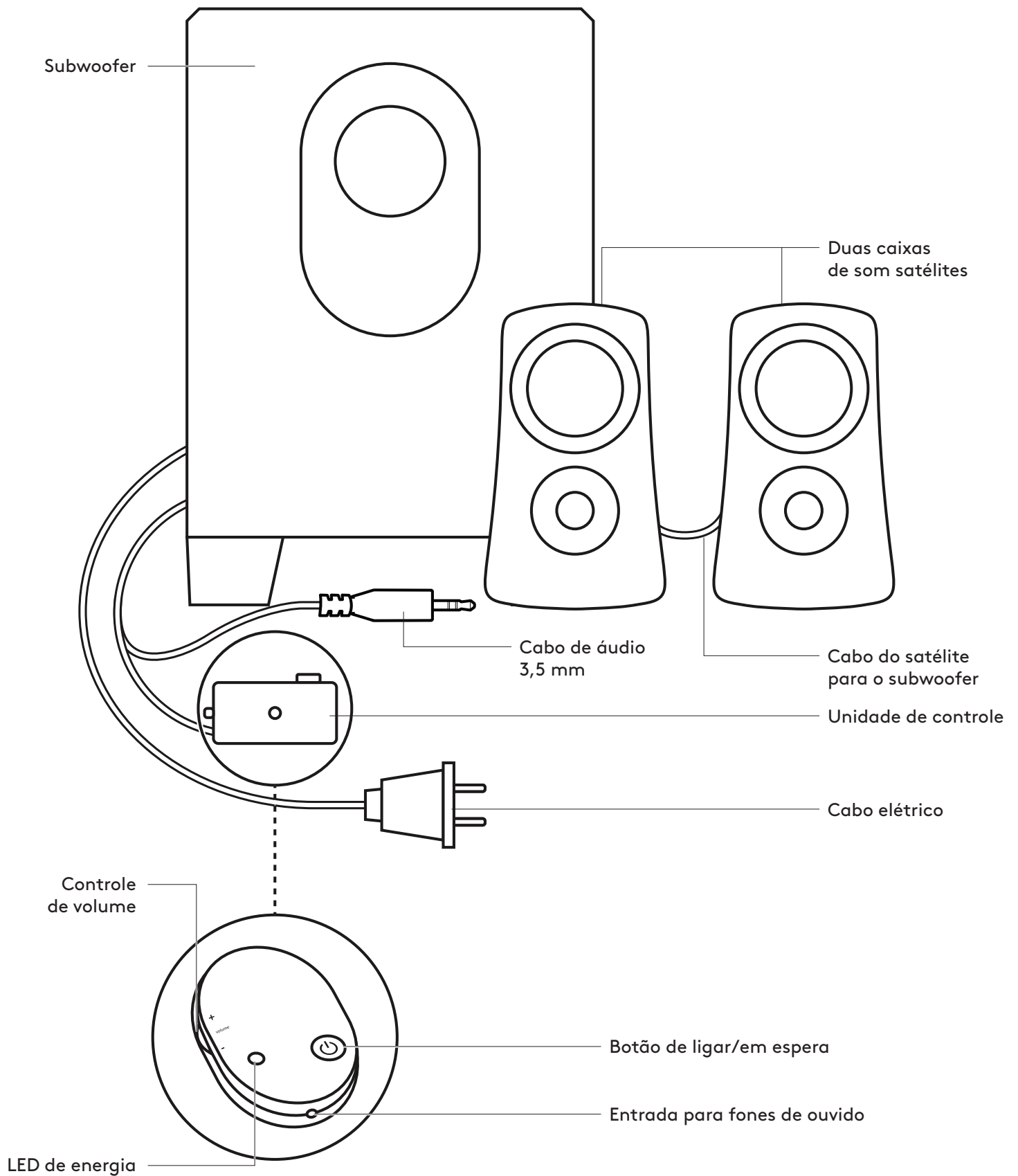

## CONECTAR OS ALTO-FALANTES

1. Conecte o cabo dos satélites à entrada do subwoofer.
2. Conecte o plugue de alimentação a uma tomada.
3. Insira o conector de 3,5 mm da unidade de controle à entrada de áudio do dispositivo (por exemplo, computador).
4. Pressione o botão de ligar/desligar na unidade de controle para ligar as caixas de som.

1

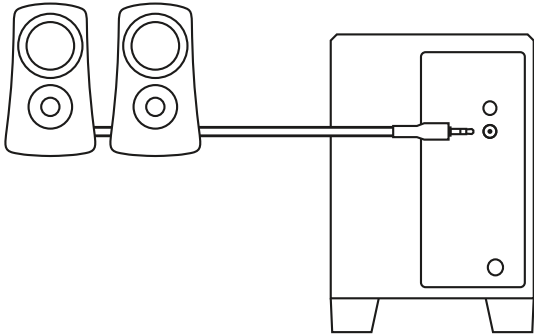

2

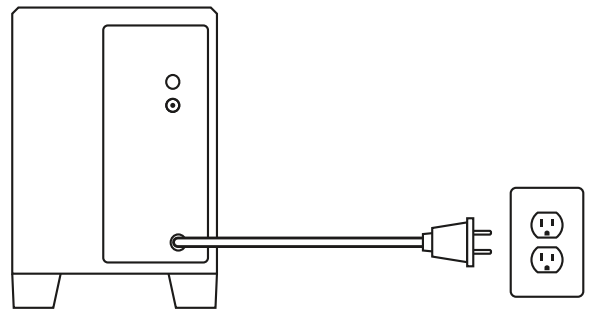

3

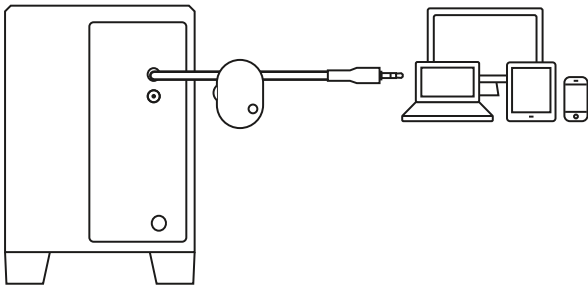

4

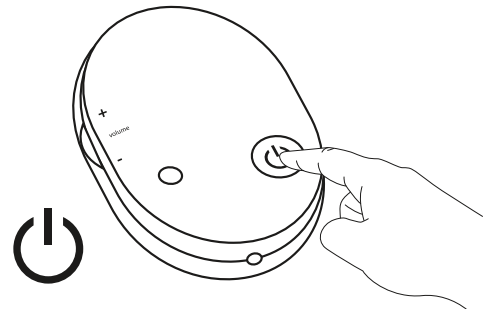

## CONECTAR OS FONES DE OUVIDO

Para usar os fones de ouvido com as caixas de som Z313, conecte-os à entrada para fones de ouvido da unidade de controle.

Para alterar o volume dos fones de ouvido, ajuste o volume da fonte de entrada de áudio.

OBSERVAÇÃO: O controle de volume na unidade de controle não controla o volume dos fones de ouvido.

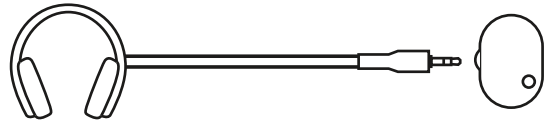

## AJUSTAR O VOLUME

Aumente (ou diminua) o volume das caixas de som rolando para cima (ou para baixo) a roda localizada no lado esquerdo da unidade de controle.

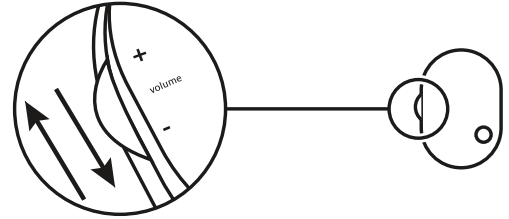

[www.logitech.com/support/Z313](http://www.logitech.com/support/Z313)

[www.logitech.com/support/Z313](http://www.logitech.com/support/Z313)

© 2019 Logitech. Logitech, Logi and other Logitech marks are owned by Logitech and may be registered. All other trademarks are the property of their respective owners. Logitech assumes no responsibility for any errors that may appear in this manual. Information contained herein is subject to change without notice.

WEB-621-001227.002

© 2019 Logitech. Logitech, Logi et les autres marques Logitech sont la propriété de Logitech et sont susceptibles d'être déposées. Toutes les autres marques sont la propriété exclusive de leurs détenteurs respectifs. Logitech décline toute responsabilité en cas d'erreurs susceptibles de s'être glissées dans le présent manuel. Les informations énoncées dans ce document peuvent faire l'objet de modifications sans préavis.

**logitech®**

