

Karinear



CERAMIC HOB

Instruction Manual / Installation Manual

80cm Ceramic Hob	90cm Ceramic Hob
KNC-D586139-MB	KNC-D596139-MB

SAFETY WARNINGS

Your safety is important to us. Please read this information before using your cooktop.

INSTALLATION

II Electrical Shock Hazard

- Disconnect the appliance from the mains electricity supply before carrying out any work or maintenance on it.
- Connection to a good system is essential and mandatory.
- Alterations to the domestic wiring system must only be made by a qualified electrician.
- Failure to follow this advice may result in electrical shock or death.

II Cut Hazard

- Take care - panel edges are sharp.
- Failure to use caution could result in injury or cuts.

II Important safety instructions

- Read these instructions carefully before installing or using this appliance.
- No combustible material or products should be placed on this appliance at any time.
- Please make this information available to the person responsible for installing the appliance as it could reduce your installation costs.
- In order to avoid a hazard, this appliance must be installed according to these instructions for installation.
- This appliance is to be properly installed and without earthed only by a suitably qualified person.
- This appliance should be connected to a circuit which incorporates an isolating switch providing full disconnection from the power supply.
- Failure to install the appliance correctly could invalidate any warranty or liability claims.

OPERATION AND MAINTENANCE

II Electrical Shock Hazard

- Do not cook on a broken or cracked cooktop. If the cooktop surface should break or crack, switch the appliance off immediately at the mains power supply (wall switch) and contact a qualified technician.
- Switch the cooktop off at the wall before cleaning or maintenance.
- Failure to follow this advice may result in electrical shock or death.

II Health Hazard

- This appliance complies with electromagnetic safety standards.

II Hot Surface Hazard

- During use, accessible parts of this appliance will become hot enough to cause burns.
- Do not let your body, clothing or any item other than suitable cookware contact the Induction glass until the surface is cool.
- Metallic objects such as knives, forks, spoons and lids should not be placed on the hob surface since they can get hot
- Keep children away.
- Handles of saucepans may be hot to touch. Check saucepan handles do not overhang other cooking zones that are on. Keep handles out of reach of children.
- Failure to follow this advice could result in burns and scalds.

II Cut Hazard

- The razor-sharp blade of a cooktop scraper is exposed when the safety cover is retracted. Use with extreme care and always store safely and out of reach of children.
- Failure to use caution could result in injury or cuts.

II Important safety instructions

- Never leave the appliance unattended when in use. Boilover causes smoking and greasy spillovers that may ignite.
- Never use your appliance as a work or storage surface.
- Never leave any objects or utensils on the appliance.
- Never use your appliance for warming or heating the room.
- After use, always turn off the cooking zones and the cooktop as described in this manual (i.e. by using the touch controls).
- Do not allow children to play with the appliance or sit, stand, or climb on it.
- Do not store items of interest to children in cabinets above the appliance. Children climbing on the cooktop could be seriously injured.
- Do not leave children alone or unattended in the area where the appliance is in use.
- Children or persons with a disability which limits their ability to use the appliance should have a responsible and competent person to instruct them in its use. The instructor should be satisfied that they can use the appliance without danger to themselves or their surroundings.
- Do not repair or replace any part of the appliance unless specifically recommended in the manual. All other servicing should be done by a qualified technician.
- Do not use a steam cleaner to clean your cooktop.
- Do not place or drop heavy objects on your cooktop.
- Do not stand on your cooktop.
- Do not use pans with jagged edges or drag pans across the Induction glass surface as this can scratch the glass.
- Do not use scourers or any other harsh abrasive cleaning agents to clean your cooktop, as these can scratch the Induction glass.
- If the supply cord is damaged, it must be replaced by the manufacturer, its service agent or similarly qualified persons in order to avoid a hazard.
- This appliance is intended to be used in household and similar applications such as: -staff kitchen areas in shops, offices and other working environments; -farm houses; -by clients in hotels, motels and other residential type environments ; -bed and breakfast type environments.
- **WARNING:** The appliance and its accessible parts become hot during use. Care should be taken to avoid touching heating elements.

Children less than 8 years of age shall be kept away unless continuously supervised.

- This appliance can be used by children aged from 8 years and above and persons with reduced physical, sensory or mental capabilities or lack of experience and knowledge if they have been given supervision or instruction concerning use of the appliance in a safe way and understand the hazards involved.
- Children shall not play with the appliance. Cleaning and user maintenance shall not be made by children without supervision.
- WARNING: Unattended cooking on a hob with fat or oil can be dangerous and may result in fire. NEVER try to extinguish a fire with water, but switch off the appliance and then cover flame e.g. with a lid or a fire blanket.
- WARNING: Danger of fire: do not store items on the cooking surfaces.
- Warning: If the surface is cracked, switch off the appliance to avoid the possibility of electric shock, for hob surfaces of glass-ceramic or similar material which protect live parts
- A steam cleaner is not to be used.
- The appliance is not intended to be operated by means of an external timer or separate remote-control system.

CONGRATULATIONS

on the purchase of your new Ceramic Hob.

We recommend that you spend some time to read this Instruction / Installation Manual in order to fully understand how to install correctly and operate it.

For installation, please read the installation section.

Read all the safety instructions carefully before use and keep this Instruction / Installation Manual for future reference.

PRODUCT OVERVIEW

II Top View

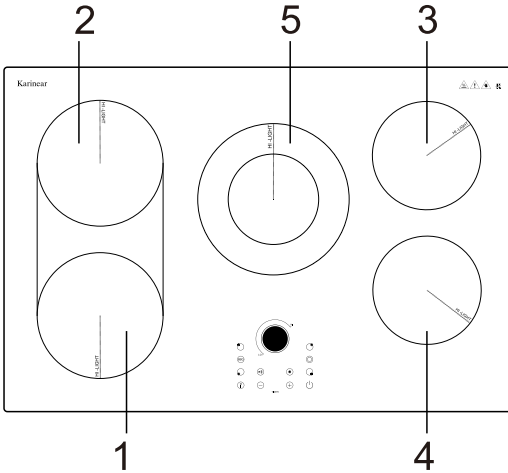

KNC-D586139-MB

- 1.190mm/1600W
- 2.190mm/1600W
- Flex zone 430*200mm
:1600W/2300W/3900W
- 3.165mm/1200W
- 4.165mm/1200W
- 5.138mm/230mm
:1100W/2300W

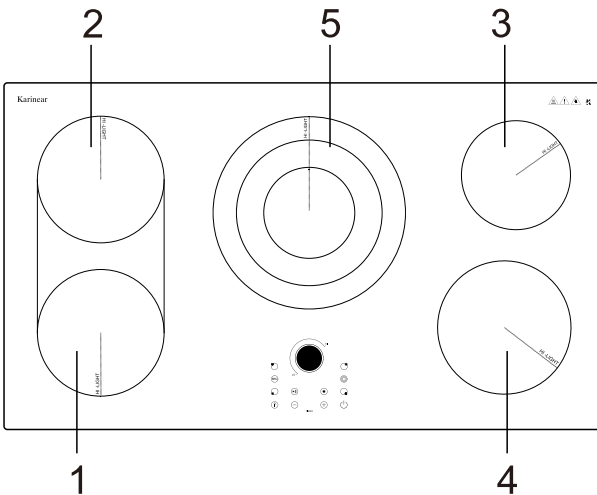

KNC-D596139-MB

- 1.190mm/1600W
- 2.190mm/1600W
- Flex zone 430*200mm
:1600W/2300W/3900W
- 3.165mm/1200W
- 4.200mm/1800W
- 5.138mm/220mm/290mm
:1050W/1950W/2700W

II Control Panel

1.ON/OFF control	2.Child lock control
3.Timer control	4. Timer regulating control
5.Heating zone selection	6. Power regulating control
7.Pause control	8.Extended zone
9.BBQ control	

KNC-D586139-MB

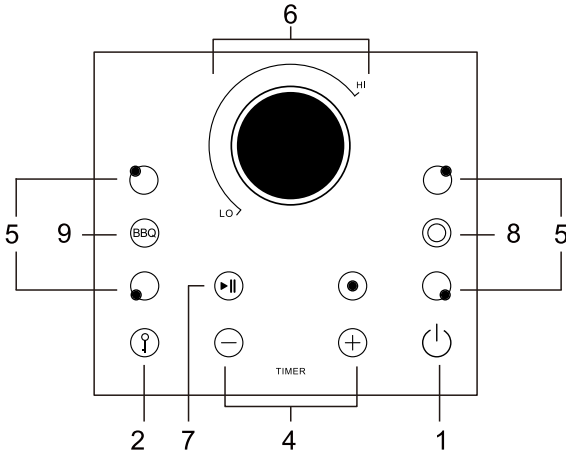

KNC-D596139-MB

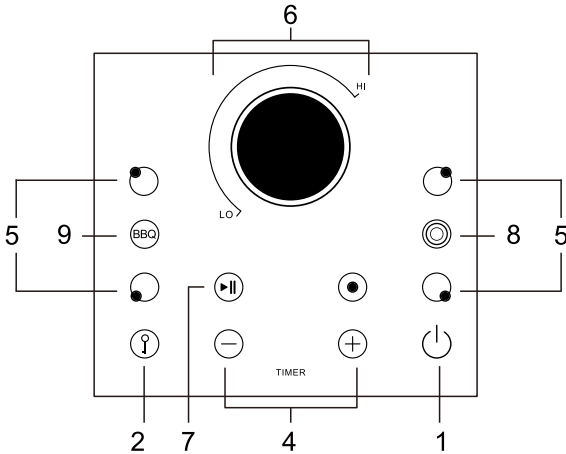

PRODUCT INFORMATION

The microcomputer ceramic cooker hob can meet different kinds of cuisine demands because of resistance wire heating, micro-computerized control and multi-power selection, really the optimal choice for modern families.

The ceramic cooker hob centers on customers and adopts personalized design. The hob has safe and reliable performances, making your life comfortable and enabling to fully enjoy the pleasure from life.

II Before using your New Hob

- Read this guide, taking special note of the 'Safety Warnings' section.
- Remove any protective film that may still be on your Induction hob.

II Using the Touch Controls

- The controls respond to touch, so you don't need to apply any pressure.
- Use the ball of your finger, not its tip.
- You will hear a beep each time a touch is registered.
- Make sure the controls are always clean, dry, and that there is no object (e.g. a utensil or a cloth) covering them. Even a thin film of water may make the controls difficult to operate.

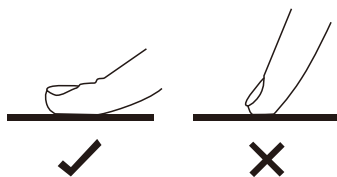

CHOOSING THE RIGHT COOKWARE

Do not use cookware with jagged edges or a curved base.



Make sure that the base of your pan is smooth, sits flat against the glass, and is the same size as the cooking zone. Always centre your pan on the cooking zone.

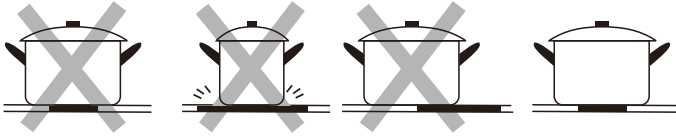

Always lift pans off the ceramic hob – do not slide, or they may scratch the glass.

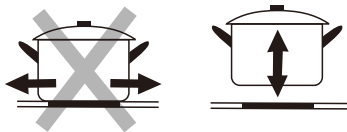

USING YOUR CERAMIC HOB

II To start cooking

• After power on, the buzzer beeps once, all the indicators light up for 1 second then go out, indicating that the ceramic hob has entered the state of standby mode.

1. Touch the ON/OFF  control. all the indicators show "--"

2. Place a suitable pan on the cooking zone that you wish to use.

- Make sure the bottom of the pan and the surface of the cooking zone are clean and dry.

3. The heating zone control only for indication, no need to touch .

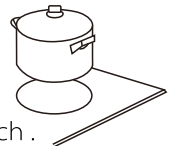

4. To set the power

First select the burner, then by turning the knob to select the power level.

*If you don't choose a heat setting within 1 minute, the ceramic hob will automatically switch off. You will need to start again at step 1. *You can modify the heat setting at any time during cooking.

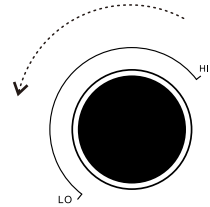
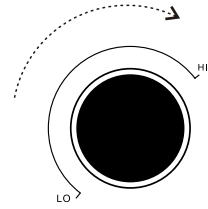

II When you have finished cooking

Switch off the cooking zone by turning the knob to "0".

2. Beware of hot surfaces

"H" will show which cooking zone is hot to touch. It will disappear when the surface has cooled down to a safe temperature. It can also be used as an energy saving function if you want to heat further pans, use the hotplate that is still hot.



3. Turn the whole cooktop off by touching the "ON/OFF" control.



LOCKING THE CONTROLS

- You can lock the controls to prevent unintended use (for example children accidentally turning the cooking zones on).
- When the controls are locked, all the controls except the ON/OFF and stop&go, control are disabled.

II To lock the controls



Touch the keylock  control. The timer indicator will show "Lo"





II To unlock the controls

1. Make sure the ceramic hob is turned on.
2. Touch and hold the keylock control  for 3-5 sec.
3. You can now start using your ceramic hob.





When the hob is in the lock mode, all the controls are disabled except the ON/OFF  and stop&go, you can always turn the ceramic hob off with the ON/OFF  control in an emergency, but you shall unlock the hob first in the next operation

II Stop&go Controls For Available Models





Touch the heating zone selection control, then touch the  key, the heating zone will stop to work, LED show "11". If you want to restart to work, touch the  key again.





II Extended Zone For Available Models

After setting the power, then touch the  key, extended zone will begin to work. If you want to cancel extended zone, select the heating zone then touch the  key again.

II Triple ring control Available Models

Touch the heating zone selection control, then touch the key dual ring  zone will begin to work. If you want to cancel dual ring zone, touch the key  again. If you want to use the triple ring zone, touch the key  2 times, triple zone will begin to work. If you want to cancel the triple zone, touch the key  for 2 times

II BBQ burner control Available Models

Touch the BBQ key , the BBQ burner will start working, turning the knob can adjust the power level of the BBQ burner. The BBQ function can be cancelled when you touch the BBQ key  again.

|| Over-Temperature Protection

A sensor installed in the hob continuously measures the temperature on the hob surface. If an excessively high temperature is detected, the hob will be automatically switched off.

When the temperature on the hob surface returns to normal, the ceramic hob becomes operational again

|| Residual Heat Warning

When the hob has been operating for some time, there will be some residual heat. The letter "H" appears to warn you to keep away from it.



|| Auto Shutdown

Another safety feature of the hob is auto shut down. This occurs whenever you forget to switch off a cooking zone. The default shutdown times are shown in the table below:

Power level	1	2	3	4	5	6	7	8	9
Default working timer (hour)	8	8	8	4	4	4	2	2	2

USING THE TIMER

- You can use the timer to set it to turn one cooking zone off or more than one after the set time is up.
- You can set the timer for up to 99 minutes. If the setting time exceeds 99 minutes, the timer will automatically return to 0 minute.

II Setting the timer for the whole hob

If the user needs to set the timer function for the whole hob, please follow the steps below:

1. Turn on the machine, touch the timer control, the timer indicator show “30” Touch “+” or “-” to set the timer.



2. When the time is set, choose the heating zone and heating level, it will begin to count down immediately. The display will show the remaining time and the timer indicator flash for 5 seconds.

3. Hold the “-” to show “00”, the timer is canceled, and the “--” will show in the minute display.



If you do not choose the heating zone and heating level, it will automatically shut down the machine after one minute, When the function timer time countdown is 0, the buzzer rings 30 times as a reminder (once per second).

NOTE:The heating will not stop after the end of this status timer, please switch off the machine in time.



II Setting the timer to turn one cooking zone off

1. To turn on the heating zone

Hint: Touch the "-" or "+" control of the timer once will decrease or increase by 1 minute.

Touch and hold the "-" or "+" control of the timer will decrease or increase by 10 minutes.

2. Touch the timer control   , the timer indicator show "30"
Touch "+" or "-" to set the timer.



3. Hold the "-" to show "00", the timer is canceled, and the "--" will show in the minute display.

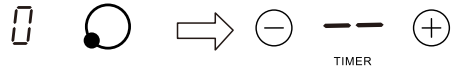

4. When the time is set, it will begin to count down immediately. The display will show the remaining time and the timer indicator flash for 5 seconds.



NOTE: The red dot next to power level indicator will illuminate indicating that zone is selected.



5. Buzzer will beep for 30 seconds and the timer indicator shows "--" when the set time finished.



II Setting the timer to turn more than one cooking zone off

1. If more than one heating zone use this function, the timer indicator will show the lowest time.

(e.g. zone 1# setting time of 3 minutes, zone 2# setting time of 6 minutes, the timer indicator shows "3".)

NOTE: The red dot next to power level indicator will flash.

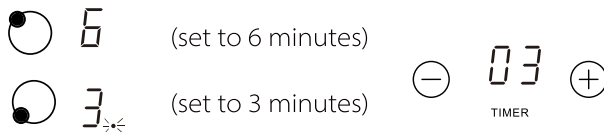

If you want to check the set time of other heating zone, by touching the + or -, the timer will indicate its set time.



2. When cooking timer expires, the corresponding cooking zone will be switched off automatically and show "H".

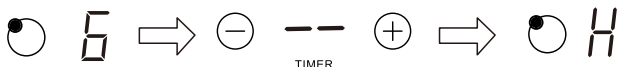

NOTE: If you want to change the time after the timer is set, you have to start from step 1

TROUBLESHOOTING

Error code	Possible cause	What to do
E4	high temperature	Please contact supplier: aftersales@karinearappliance.com
F4	circuit open	Please contact supplier: aftersales@karinearappliance.com

COOKING GUIDELINES (FOR REFERENCE ONLY)

II Cooking Tips

- When food comes to the boil, reduce the power setting.
- Using a lid will reduce cooking times and save energy by retaining the heat.
- Minimize the amount of liquid or fat to reduce cooking times.
- Start cooking on a high setting and reduce the setting when the food has heated through.

II Simmering, cooking rice

- Simmering occurs below boiling point, at around 85°C, when bubbles are just rising occasionally to the surface of the cooking liquid. It is the key to delicious soups and tender stews because the flavours develop without overcooking the food. You should also cook egg-based and flourthickened sauces below boiling point.
- Some tasks, including cooking rice by the absorption method, may require a setting higher than the lowest setting to ensure the food is cooked properly in the time recommended.

II Searing steak

To cook juicy flavoursome steaks:

1. Stand the meat at room temperature for about 20 minutes before cooking.
2. Heat up a heavy-based frying pan.
3. Brush both sides of the steak with oil. Drizzle a small amount of oil into the hot pan and then lower the meat onto the hot pan.
4. Turn the steak only once during cooking. The exact cooking time will depend on the thickness of the steak and how cooked you want it. Times may vary from about 2 – 8 minutes per side. Press the steak to gauge how cooked it is – the firmer it feels the more 'well done' it will be.
5. Leave the steak to rest on a warm plate for a few minutes to allow it to relax and become tender before serving.

II For stir-frying

1. Choose an ceramic compatible flat-based wok or a large frying pan.
2. Have all the ingredients and equipment ready. Stir-frying should be quick. If cooking large quantities, cook the food in several smaller batches.
3. Preheat the pan briefly and add two tablespoons of oil.
4. Cook any meat first, put it aside and keep warm.
5. Stir-fry the vegetables. When they are hot but still crisp, turn the cooking zone to a lower setting, return the meat to the pan and add your sauce.
6. Stir the ingredients gently to make sure they are heated through.
7. Serve immediately.

HEAT SETTINGS

Heat setting	Suitability
1 - 2	<ul style="list-style-type: none">• delicate warming for small amounts of food• melting chocolate, butter, and foods that burn quickly• gentle simmering• slow warming
3 - 4	<ul style="list-style-type: none">• reheating• rapid simmering• cooking rice
5 - 6	<ul style="list-style-type: none">• pancakes
7 - 8	<ul style="list-style-type: none">• sauteing• cooking pasta
9	<ul style="list-style-type: none">• stir-frying• searing• bringing soup to the boil• boiling water

CARE AND CLEANING

What?	How?	Important!
<p>Everyday soiling on glass (fingerprints, marks, stains left by food or non-sugary spillovers on the glass)</p>	<ol style="list-style-type: none"> 1. Switch the power to the cooktop off. 2. Apply a cooktop cleaner while the glass is still warm (but not hot!) 3. Rinse and wipe dry with a clean cloth or paper towel. 4. Switch the power to the cooktop back on. 	<ul style="list-style-type: none"> • When the power to the cooktop is switched off, there will be no 'hot surface' indication but the cooking zone may still be hot! Take extreme care. • Heavy-duty scourers, some nylon scourers and harsh/abrasive cleaning agents may scratch the glass. Always read the label to check if your cleaner or scourer is suitable. • Never leave cleaning residue on the cooktop: the glass may become stained.
<p>Boilovers, melts, and hot sugary spills on the glass</p>	<p>Remove these immediately with a fish slice, palette knife or razor blade scraper suitable for ceramic glass cooktops, but beware of hot cooking zone surfaces:</p> <ol style="list-style-type: none"> 1. Switch the power to the cooktop off at the wall. 2. Hold the blade or utensil at a 30° angle and scrape the soiling or spill to a cool area of the cooktop. 3. Clean the soiling or spill up with a dish cloth or paper towel. 4. Follow steps 2 to 4 for 'Everyday soiling on glass' above. 	<ul style="list-style-type: none"> • Remove stains left by melts and sugary food or spillovers as soon as possible. If left to cool on the glass, they may be difficult to remove or even permanently damage the glass surface. • Cut hazard: when the safety cover is retracted, the blade in a scraper is razor-sharp. Use with extreme care and always store safely and out of reach of children.
<p>Spillovers on the touch controls</p>	<ol style="list-style-type: none"> 1. Switch the power to the cooktop off. 2. Soak up the spill 3. Wipe the touch control area with a clean damp sponge or cloth. 4. Wipe the area completely dry with a paper towel. 5. Switch the power to the cooktop back on. 	<ul style="list-style-type: none"> • The cooktop may beep and turn itself off, and the touch controls may not function while there is liquid on them. Make sure you wipe the touch control area dry before turning the cooktop back on.

HINTS AND TIPS

Problem	Possible causes	What to do
The cooktop cannot be turned on.	No power.	Make sure the cooktop is connected to the power supply and that it is switched on. Check whether there is a power outage in your home or area. If you've checked everything and the problem persists, call a qualified technician.
The touch controls are unresponsive.	The controls are locked.	Unlock the controls. See section 'Using your ceramic cooktop' for instructions.
The touch controls are difficult to operate.	There may be a slight film of water over the controls or you may be using the tip of your finger when touching the controls.	Make sure the touch control area is dry and use the ball of your finger when touching the controls.
The glass is being scratched.	Rough-edged cookware. Unsuitable, abrasive scourer or cleaning products being used.	Use cookware with flat and smooth bases. See 'Choosing the right cookware'. See 'Care and cleaning'.
Some pans make crackling or clicking noises.	This may be caused by the construction of your cookware (layers of different metals vibrating differently).	This is normal for cookware and does not indicate a fault.

TECHNICAL SPECIFICATION

Model	KNC-D586139-MB
Cooking zones	5 Zones
Supply voltage/Frequency/Ampere	240V~, 60Hz,40A
Installed Electric Power	8600W
Product Size LxWxH(mm)	770X520X74
Built-in Dimensions AxB(mm)	740X490

Model	KNC-D596139-MB
Cooking zones	5 Zones
Supply voltage/Frequency/Ampere	240V~, 60Hz,40A
Installed Electric Power	9600W
Product Size LxWxH(mm)	900X520X74
Built-in Dimensions AxB(mm)	870X490

INSTALLATION

II Selection of installation equipment

Cut out the work surface according to the sizes shown in the drawing. For the purpose of installation and use, a minimum of 5 cm space shall be preserved around the hole.

Be sure the thickness of the work surface is at least 30mm. Please select heat-resistant work surface material to avoid larger deformation caused by the heat radiation from the hotplate. As shown below:

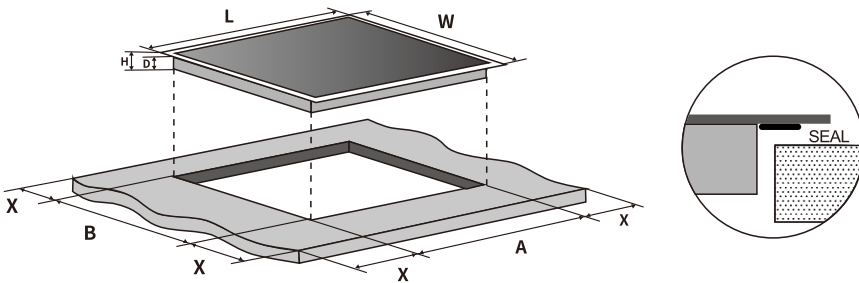

Model: KNC-D586139-MB

L(mm)	W(mm)	H(mm)	D(mm)	A(mm)	B(mm)	X(mm)
770	520	74	70	740	490	50mini

Model: KNC-D596139-MB

L(mm)	W(mm)	H(mm)	D(mm)	A(mm)	B(mm)	X(mm)
900	520	74	70	870	490	50mini

Under any circumstances, make sure the Ceramic cooker hob is well ventilated and the air inlet and outlet are not blocked. Ensure the Induction cooker hob is in good work state. As shown below



Note: The safety distance between the hotplate and the cupboard above the hotplate should be at least 760mm.

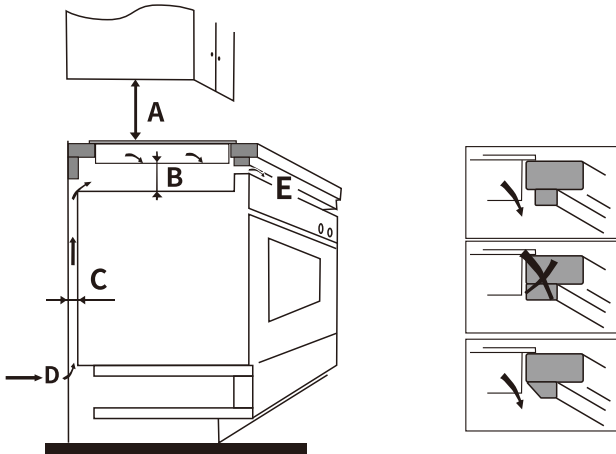

A(mm)	B(mm)	C(mm)	D	E
760	50 mini	30 mini	Air intake	Air exit 10 mm

II Before locating the fixing brackets

The unit should be placed on a stable, smooth surface (use the packaging). Do not apply force onto the controls protruding from the hob. Fix the hob on the work surface by screw four brackets on the bottom of hob (see picture) after installation.

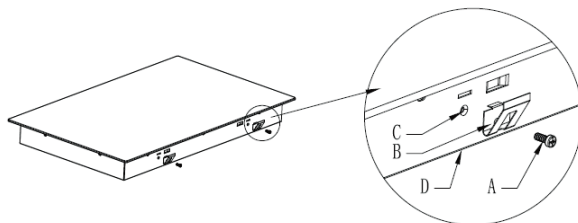

A	B	C	D
screw	bracket	Screw hole	base

Adjust the bracket position to suit for different work surface's thickness.

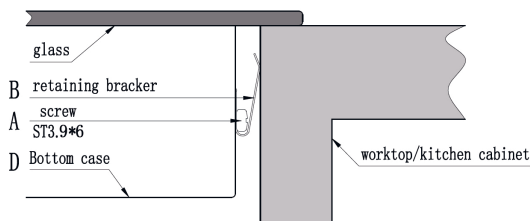

II Cautions

1. The ceramic cooker hob must be installed by qualified personnel or technicians. We have professionals at your service. Please never conduct the operation by yourself.
2. The ceramic cooker hob shall not be mounted to cooling equipment, dishwashers and rotary dryers.
3. The ceramic cooker hob shall be installed such that better heat radiation can be ensured to enhance its reliability.
4. The wall and induced heating zone above the work surface shall withstand heat.
5. To avoid any damage, the sandwich layer and adhesive must be resistant to heat.
6. A steam cleaner is not to be used.

7. This ceramic can be connected only to a supply with system impedance no more than 0.427 ohm. In case necessary, please consult your supply authority for system impedance information.

II Connecting the hob to the mains power supply

The power supply should be connected in compliance with the relevant standard, The method of connection is shown below.

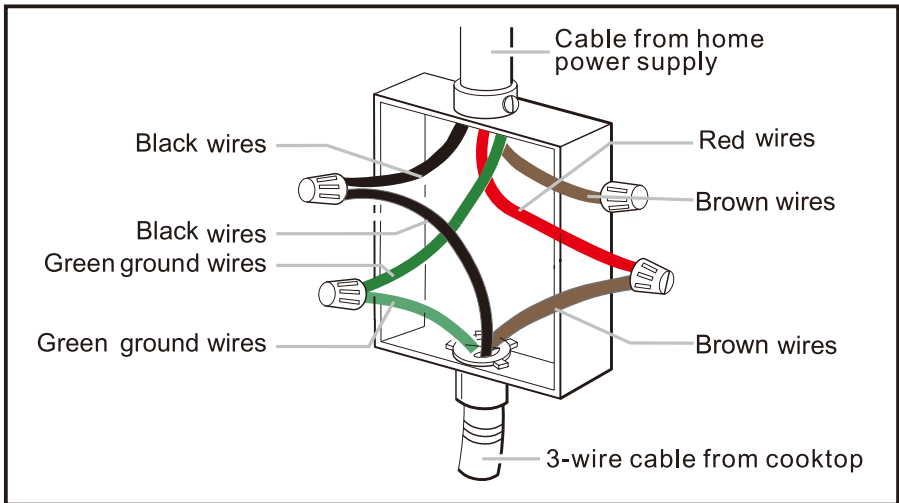

1. If the cable is damaged or needs replacing, this should be done by an after-sales technician using the proper tools, so as to avoid any accidents.

2. If the appliance is being connected directly to the mains supply, an omnipolar circuit breaker must be installed with a minimum gap of 3mm between the contacts.

3. The installer must ensure that the correct electrical connection has been made and that it complies with safety regulations.

4. The cable must not be bent or compressed.

5. The cable must be checked regularly and only replaced by a properly qualified person.

Recycling and Disposal

Environmental Protection

Waste electrical products should not be disposed of with household waste. Please recycle where facilities exist. Check with your Local Authority or retailer for recycling advice.



The symbol on the product or its packaging indicates that this product cannot be treated as normal household waste. This product must be handed over to an electric and electronic equipment collection point for recycling.

On ensuring that this product is disposed of correctly, you will help to avoid possible negative consequences for the environment and public health, which could occur if this product is not handled correctly. To receive more detailed information about recycling this product, contact your local government, domestic waste disposal services or the outlet where the product was bought.

FCC Warning Statement

Changes or modifications not expressly approved by the party responsible for compliance could void the user's authority to operate the equipment. This equipment has been tested and found to comply with the limits for a Class B digital device, pursuant to Part 15 of the FCC Rules. These limits are designed to provide reasonable protection against harmful interference in a residential installation. This equipment generates uses and can radiate radio frequency energy and, if not installed and used in accordance with the instructions, may cause harmful interference to radio communications. However, there is no guarantee that interference will not occur in a particular installation. If this equipment does cause harmful interference to radio or television reception, which can be determined by turning the equipment off and on, the user is encouraged to try to correct the interference by one or more of the following measures:

- Reorient or relocate the receiving antenna.
- Increase the separation between the equipment and receiver.
- Connect the equipment into an outlet on a circuit different from that to which the receiver is connected.
- Consult the dealer or an experienced radio/TV technician for help.

This device complies with part 15 of the FCC Rules. Operation is subject to the following two conditions: (1) This device may not cause harmful interference, and (2) this device must accept any interference received, including interference that may cause undesired operation.