

Installation Instructions for **EQUIPMENT STANDS**



**CHECK FOR CONCEALED DAMAGE
FILE CLAIM WITH DELIVERING FREIGHT CARRIER**

Equipment Stands manufactured by **ADVANCE TABCO** are designed and constructed for applications including Food Preparation, Cooking, Manufacturing, Material Handling, Laboratory Service and the like. **ADVANCE TABCO** does not recommend product use for activities employing harsh and active chemicals. Consult factory regarding unusual applications.



Edgewood, New York 11717-8380

2-2007

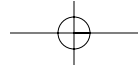
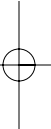
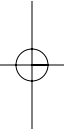

Contents:
 Table Top
 Undershelf
 Legs
 Set Screws

Tools Required:
 5/32" Allen Wrench

NSF Installations require all set screws filled with an approved silicone sealer.

Step 1:

Lay the table top flat on the box to protect the finish during assembly. **(Figure 1)**

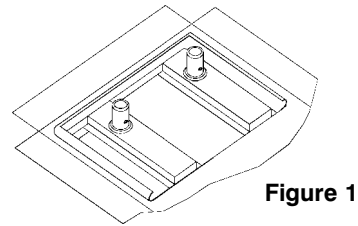

Figure 1

Step 2:

Remove plastic cap from gusset. **(Figure 2)** Set screws are located inside gusset.

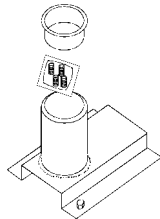

Figure 2

Step 3:

Insert set screws into adjustable shelf corner - (2) each corner (underneath shelf). Insert legs into adjustable shelf corner and set desired height. Tighten set screws. **(Figure 3)**

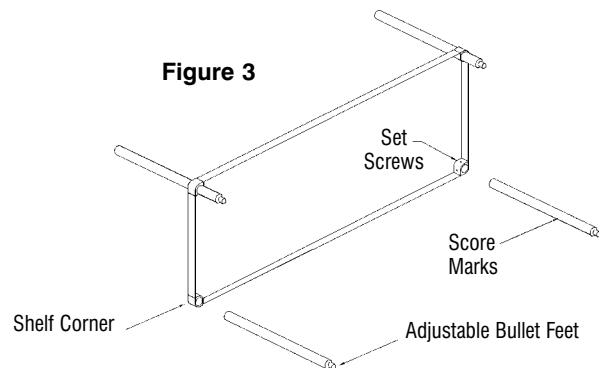

Figure 3

Step 4:

Insert legs and undershelf assembly into gussets as indicated in **Figure 4**. Tighten set screws.

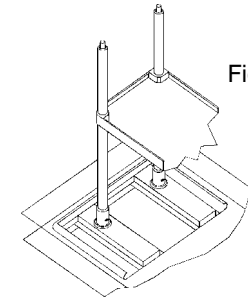

Figure 4

Step 5:

Turn table upright and level by adjusting bullet feet.

