

Register your product and get support at
www.philips.com/support

50PFL3708
46PFL3708
40PFL4708
40PFL1708
39PFL2708
32PFL3508
32PFL4508
29PFL4508
24PFL4508

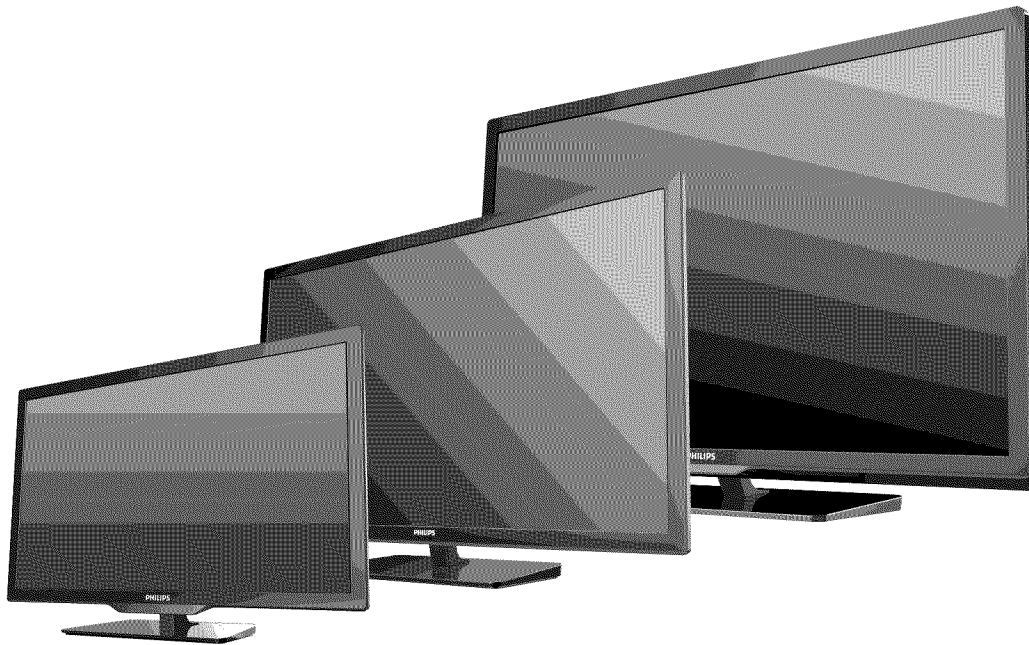

EN User Manual

ES Manual del Usuario

FR Manuel d'Utilisation

EN For further assistance, call the customer support service in your country.

- To obtain assistance, contact Philips Customer Care Center;
In the U.S.A., Canada, Puerto Rico, or the U.S. Virgin Islands **1 866 309 5962**
México D.F. and Área Metropolitana; **58 87 97 36**
Interior de la Republica; **01 800 839 19 89**

ES Para obtener más información, llame al servicio de soporte al cliente de su país.

- Para obtener asistencia, comuníquese con Centro de atención al cliente de Philips;
En los Estados Unidos, en Canadá, Puerto Rico o en las Islas Vírgenes de los
Estados Unidos; **1 866 309 5962**
México D.F. y Área Metropolitana; **58 87 97 36**
Interior de la Republica; **01 800 839 19 89**

FR Pour obtenir de l'aide supplémentaire, communiquez avec le centre de service à la clientèle de votre pays.

- Pour obtenir de l'aide, communiquez avec le centre de service à la clientèle Philips au;
Dans le États-Unis, au Canada, à Puerto Rico ou aux Îles Vierges américaines; **1 866 309 5962**
México D.F. et Área Metropolitana; **58 87 97 36**
Interior de la Republica; **01 800 839 19 89**

PHILIPS

Contents

1 Notice	5	5 Use more of your TV	22
2 Important	6	Displaying the Main Menu	22
Positioning the TV	6	Picture	23
Regulatory notices	6	Sound	24
Environmental care	6	Setup	24
3 Get started	7	Autoprogram	24
Features	7	Channel list	25
Supplied accessories	7	Add channels	25
Symbols used in this User Manual	7	Antenna confirmation	25
Stand assembly	8	Features	26
Attaching the base	8	Caption settings	26
Managing cables	9	Child and ratings lock	27
Installing the remote control batteries	9	Channel lock	27
Remote control	10	Setting US movie and TV ratings	28
Control panel	11	Canadian English or Canadian French ratings	29
Terminals	11	Change PIN	29
Connecting the antenna or the cable	12	PC settings	29
Connecting a set-top box, Blu-ray disc / DVD recorder via		EasyLink (HDMI CEC)	30
composite connectors and Analog Audio	12	Device list	30
Plugging in the AC power cord	12	Setting your location to home	31
Selecting your connection quality	13	E-sticker	31
HDMI - Highest quality	13	Language	31
Component (Y Pb Pr) - High quality	13	USB	32
Composite - Basic quality	13	Picture (JPEG)	32
Connecting your devices	13	Video (Motion JPEG)	32
HDMI Digital connection	13	6 Upgrade your TV software	33
HDMI-DVI connection	13	Checking your current software version	33
Component Analog Video Connection	14	Upgrading the software	33
Composite Analog Video Connection	14	7 Useful tips	34
Digital Audio Output Connection	14	FAQ	34
PC connection	15	Troubleshooting	35
USB Memory Stick	15	8 Information	36
Initial setup	16	Glossary	36
4 Use your TV	18	Maintenance	36
Switching on your TV and putting it in Standby mode	18	9 Specifications	37
Adjusting volume	18	10 Warranty	38
Switching channels	18		
Watching channels from an external device	19		
Sleep timer	19		
Switching audio mode	19		
EasyLink options	20		
Changing picture format	20		
TV screen information	21		

**Register online at www.productrecords.com/phl today
to get the very most from your purchase.**

Registering your model with Philips makes you eligible for all of the valuable benefits listed below, so don't miss out.

Register online at www.productrecords.com/phl to ensure:

*Product Safety Notification

By registering your product, you'll receive notification - directly from the manufacturer - in the rare case of a product recall or safety defect.

*Additional Benefits

Registering your product guarantees that you'll receive all of the privileges to which you're entitled, including special money-saving offers.

Know these **safety** symbols



The caution marking is located on the rear or bottom of the cabinet.



The lightning flash with arrowhead symbol, within an equilateral triangle, is intended to alert the user to the presence of uninsulated "dangerous voltage" within the apparatus's enclosure that may be of sufficient magnitude to constitute a risk of electric shock to persons.



The exclamation point within an equilateral triangle is intended to alert the user to the presence of important operating and maintenance (servicing) instructions in the literature accompanying the apparatus.

WARNING: To reduce the risk of fire or electric shock, do not expose this apparatus to rain or moisture. Apparatus shall not be exposed to dripping or splashing and no objects filled with liquids, such as vases, shall be placed on the apparatus.

CAUTION: To prevent electric shock, match wide blade of plug to wide slot, fully insert.

ATTENTION: Pour éviter les choc électriques, introduire la lame la plus large de la fiche dans la borne correspondante de la prise et pousser jusqu'au fond.

PHILIPS Visit our World Wide Web Site at www.philips.com/support

CHILD SAFETY:

PROPER TELEVISION PLACEMENT MATTERS

THE CONSUMER ELECTRONICS INDUSTRY CARES

- Manufacturers, retailers and the rest of the consumer electronics industry are committed to making home entertainment safe and enjoyable.
- As you enjoy your television, please note that all televisions – new and old- must be supported on proper stands or installed according to the manufacturer's recommendations. Televisions that are inappropriately situated on dressers, bookcases, shelves, desks, speakers, chests, carts, etc., may fall over, resulting in injury.

TUNE IN TO SAFETY

- **ALWAYS** follow the manufacturer's recommendations for the safe installation of your television.
- **ALWAYS** read and follow all instructions for proper use of your television.
- **NEVER** allow children to climb on or play on the television or the furniture on which the television is placed.
- **NEVER** place the television on furniture that can easily be used as steps, such as a chest of drawers.
- **ALWAYS** install the television where it cannot be pushed, pulled over or knocked down.
- **ALWAYS** route cords and cables connected to the television so that they cannot be tripped over, pulled or grabbed.

WALL OR CEILING MOUNT YOUR TELEVISION

- **ALWAYS** contact your retailer about professional installation if you have any doubts about your ability to safely mount your television.
- **ALWAYS** use a mount that has been recommended by the television manufacturer and has a safety certification by an independent laboratory (such as UL, CSA, ETL).
- **ALWAYS** follow all instructions supplied by the television and mount manufacturers.
- **ALWAYS** make sure that the wall or ceiling where you are mounting the television is appropriate. Some mounts are not designed to be mounted to walls and ceilings with steel studs or cinder block construction. If you are unsure, contact a professional installer.
- Televisions can be heavy. A minimum of two people is required for a wall or ceiling mount installation.

MOVING AN OLDER TELEVISION TO A NEW PLACE IN YOUR HOME

- Many new television buyers move their older CRT televisions into a secondary room after the purchase of a flat-panel television. Special care should be made in the placement of older CRT televisions.
- **ALWAYS** place your older CRT television on furniture that is sturdy and appropriate for its size and weight.
- **NEVER** place your older CRT television on a dresser where children may be tempted to use the drawers to climb.
- **ALWAYS** make sure your older CRT television does not hang over the edge of your furniture.

CE.org/safety



Important Safety Instructions

1. Read these instructions.
2. Keep these instructions.
3. Heed all warnings.
4. Follow all instructions.
5. Do not use this apparatus near water.
6. Clean only with dry cloth.
7. Do not block any ventilation openings. Install in accordance with the manufacturer's instructions.
8. Do not install near any heat sources such as radiators, heat registers, stoves, or other apparatus (including amplifiers) that produce heat.
9. Do not defeat the safety purpose of the polarized or grounding-type plug. A polarized plug has two blades with one wider than the other. A grounding type plug has two blades and a third grounding prong. The wide blade or the third prong are provided for your safety. If the provided plug does not fit into your outlet, consult an electrician for replacement of the obsolete outlet.
10. Protect the power cord from being walked on or pinched particularly at plugs, convenience receptacles, and the point where they exit from the apparatus.
11. Only use attachments / accessories specified by the manufacturer.
12. Use only with the cart, stand, tripod, bracket, or table specified by the manufacturer; or sold with the apparatus. When a cart is used, use caution when moving the cart / apparatus combination to avoid injury from tip-over.



13. Unplug this apparatus during lightning storms or when unused for long periods of time.
14. Refer all servicing to qualified service personnel. Servicing is required when the apparatus has been damaged in any way, such as power-supply cord or plug is damaged, liquid has been spilled or objects have fallen into the apparatus, the apparatus has been exposed to rain or moisture, does not operate normally, or has been dropped.

Note to the CATV system installer:

This reminder is provided to call the CATV system installer's attention to Article 820-40 of the NEC that provides guidelines for proper grounding and, in particular, specifies that the cable ground shall be connected to the grounding system of the building, as close to the point of cable entry as practical.

Example of Antenna Grounding as per NEC – National Electric Code

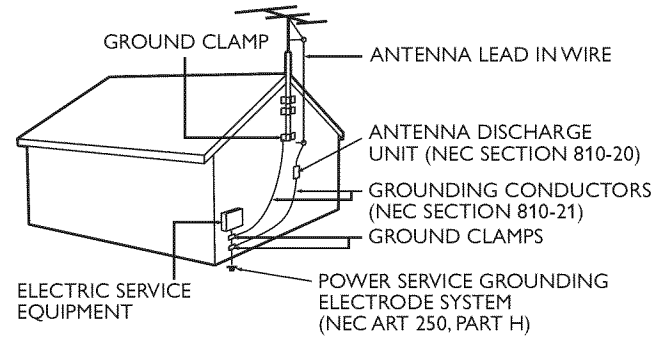

Wall Mount Bracket Kit

	Brand	Model #	Screw dimension
50PFL3708 / 46PFL3708	PHILIPS	SQM6485	M6 x 1.614" (41mm) with spacer
40PFL4708 / 39PFL2708	PHILIPS	SQM6435/17	M6 x 1.614" (41mm) with spacer
40PFL1708	SANUS	SAN25BB	M4 x 0.472" (12mm)
32PFL3508 / 32PFL4508 / 29PFL4508	SANUS	SAN18B	M4 x 0.472" (12mm)
24PFL4508	SANUS	MST15	M4 x 0.472" (12mm)

- The recommended Wall Mount Bracket Kit (sold separately) allows the mounting of the TV on the wall.
- For detailed information on installing the wall mount, refer to the Wall Mount Instruction Book.
- P&F USA is not responsible for any damage to the product or injury to yourself or others if you elect to install the TV Wall Mount Bracket or mount the TV onto the Bracket on your own.
- The Wall Mount Bracket must be installed by experts.

P&F USA is not liable for these types of accidents or injury noted below.

- Install the Wall Mount Bracket on a sturdy vertical wall.
- If installed onto a ceiling or slanted wall, the TV and Wall Mount Bracket may fall which could result in a severe injury.
- Do not use screws that are longer or shorter than their specified length. If screws too long are used this may cause mechanical or electrical damage inside the TV set. If screws too short are used this may cause the TV set to fall.
- Do not fasten the screws by excessive force. This may damage the product or cause the product to fall, leading to an injury.
- For safety reasons use 2 people to mount the TV onto a Wall Mounting Bracket.
- Do not mount the TV onto the Wall Mounting Bracket while your TV is plugged in or Turned On. It may result in an electrical shock injury.

When installing the unit on the wall, allow this much space.

- Top: 11.8 inches (30cm)
- Left and right side: 5.9 inches (15cm)
- Bottom: 3.9 inches (10cm)



1 Notice

Trademarks are the property of Koninklijke Philips N.V. or their respective owners.

P&F USA reserves the right to change products at any time without being obliged to adjust earlier supplies accordingly.

The material in this manual is believed adequate for the intended use of the system. If the product or its individual modules or procedures are used for purposes other than those specified herein, confirmation of their validity and suitability must be obtained. P&F USA warrants that the material itself does not infringe any United States patents. No further warranty is expressed or implied.

P&F USA cannot be held responsible neither for any errors in the content of this document nor for any problems as a result of the content in this document. Errors reported to P&F USA will be adapted and published on the P&F USA support website as soon as possible.

Pixel characteristics

This LCD product has a high number of color pixels. Although it has effective pixels of 99.999% or more, black dots or bright points of light (red, green or blue) may appear constantly on the screen. This is a structural property of the display (within common industry standards) and is not a malfunction.

Warranty

No components are user serviceable. Do not open or remove covers to the inside of the product. Repairs may only be done by Service Centers and official repair shops. Failure to do so shall void any warranty, stated or implied.

Any operation expressly prohibited in this manual, any adjustments or assembly procedures not recommended or authorized in this manual shall void the warranty.

Federal Communications Commission Notice

This equipment has been tested and found to comply with the limits for a Class B Digital device, pursuant to part 15 of the FCC Rules. These limits are designed to provide reasonable protection against harmful interference in a residential installation. This equipment generates, uses and can radiate radio frequency energy and, if not installed and used in accordance with the instructions, may cause harmful interference to radio communications. However, there is no guarantee that interference will not occur in a particular installation. If this equipment does cause harmful interference to radio or television reception, which can be determined by turning the equipment off and on, the user is encouraged to try to correct the interference by one or more of the following measures:

- Reorient or relocate the receiving antenna.
- Increase the separation between the equipment and the receiver.
- Connect the equipment into an outlet on a circuit different from that to which the receiver is connected.
- Consult the dealer or an experienced radio or television technician for help.

Declaration of Conformity

Trade Name : PHILIPS
 Responsible Party : P&F USA, Inc.
 Model : 50PFL3708, 46PFL3708, 40PFL4708,
 40PFL1708, 39PFL2708, 32PFL3508,
 32PFL4508, 29PFL4508, 24PFL4508
 Address : PO Box 2248, Alpharetta, GA 30023-2248
 U.S.A.
 Telephone Number : 1 866 309 5962

Modifications

This apparatus may generate or use radio frequency energy. Changes or modifications to this apparatus may cause harmful interference unless the modifications are expressly approved in the User Manual. The user could lose the authority to operate this apparatus if an unauthorized change or modification is made.

Cables

Connections to this device must be made with shielded cables with metallic RFI / EMI connector hoods to maintain compliance with FCC Rules and Regulations.

Canadian notice

CAN ICES-3 (B)/NMB-3 (B)
 Standard Television Receiving Apparatus, Canada BETS-7 / NTMR-7.

Copyright

All other registered and unregistered trademarks are the property of their respective owners.



The terms HDMI and HDMI High-Definition Multimedia Interface, and the HDMI Logo are trademarks or registered trademarks of HDMI Licensing LLC in the United States and other countries.



Manufactured under license from Dolby Laboratories. Dolby and the double-D symbol are trademarks of Dolby Laboratories.



SRS is a trademark of SRS Labs, Inc. TruSurround XT technology is incorporated under license from SRS Labs, Inc. SRS TruSurround XT® creates a truly immersive surround sound experience with rich bass and clear dialog from only two speakers.

* SRS TruSurround XT technology is supported in 40PFL4708, 39PFL2708, 32PFL3508, 32PFL4508, 29PFL4508, 24PFL4508 only.



ENERGY STAR® is a joint program of the U.S. Environmental Protection Agency and the U.S. Department of Energy helping us all save money and protect the environment through energy efficient products and practices.

Consumer Notice:

This TV has been set to maximize energy efficiency while delivering the best possible picture using the factory installed home mode settings. Changing or enabling other features in this TV (e.g. brightened backlighting) will possibly increase energy consumption beyond the original ENERGY STAR® qualified limits.



LED backlighting technology uses less energy when compared with a standard CCFL backlighting LCD television of the same screen size. Actual energy savings will vary depending on the screen size.

Portions of this software are copyright © The FreeType Project (www.freetype.org).

The American Academy of Pediatrics discourages television viewing for children younger than two years of age.

2 Important

Positioning the TV

- Large screen TVs are heavy. 2 people are required to carry and handle a large screen TV.
- Make sure to hold the upper and bottom frames of the unit firmly as illustrated.
- Install the unit in a horizontal and stable position.
- Do not install the unit in direct sunlight or in a place subject to dust or strong vibration.
- Depending on the environment, the temperature of this unit may increase slightly. This is not a malfunction.
- Avoid a place with drastic temperature changes.
- Do not place anything directly on top or bottom of the unit.
- Depending on your external devices, noise or disturbance of the picture and / or sound may be generated if the unit is placed too close to them. In this case, please ensure enough space between the external devices and the unit.
- Do not insert the AC power cord into the power socket outlet before all the connections are made.
- Ensure that you always have easy access to the AC power cord or plug to disconnect the TV from the power.
- Before you move the TV, disconnect attached cables to prevent damage to connectors.
- Be sure to unplug the AC power cord from the AC outlet before moving or carrying the unit.

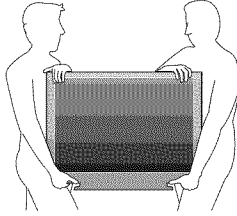

Regulatory notices

Do not place the unit on the furniture that is capable of being tilted by a child and an adult leaning, pulling, standing or climbing on it. A falling unit can cause serious injury or even death.

This apparatus should not be placed in a built-in installation such as a bookcase or rack unless proper ventilation is provided. Make sure to leave a space of 4 inches (10cm) or more around this apparatus.

Press \odot to turn the unit on and go into standby mode. To completely turn Off the unit, you must unplug the AC power cord. Disconnect the AC plug to shut the unit off when trouble is found or not in use. The AC plug shall remain readily available.

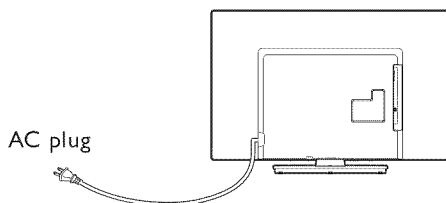

Never use a gas duster on this TV. The gas trapped inside of this unit may cause ignition and explosion.

CAUTION: Danger of explosion if battery is incorrectly replaced. Replace only with the same or equivalent type.

WARNING: Batteries (battery pack or battery installed) shall not be exposed to excessive heat such as sunshine, fire or the like.

WARNING: To prevent injury, this apparatus must be securely attached to the furniture / wall in accordance with the instructions. Tipping, shaking, or rocking the unit may cause injury / death.

Environmental care

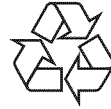

The packaging of this product is intended to be recycled.

Contact your local authorities for information about how to recycle the packaging.

For product recycling information, please visit - www.recycle.philips.com

End of life directives



Philips pays a lot of attention to produce environment-friendly products in green focal areas. Your new TV contains materials which can be recycled and reused. At the end of its life, specialized companies can dismantle the discarded TV to concentrate the reusable materials and to minimize the amount of materials to be disposed of. Please ensure you dispose of your old TV according to local regulations.

Disposal of used batteries

The batteries supplied do not contain the heavy metals mercury and cadmium. Nevertheless, in many areas batteries may not be disposed of with your household waste. Please ensure you dispose of batteries according to local regulations.

3 Get started

Features

- **DTV / Analog TV / CATV**
You can use your remote control to select channels which are broadcast in Digital format and conventional Analog format. Also, cable subscribers can access their cable TV channels.
- **Information display**
This unit can display the title, contents (DTV only) and other information of the current program on the TV screen.
- **Autoprogram**
This unit automatically scans and memorizes channels available in your area, eliminating difficult setup procedures.
- **Child lock**
This feature allows you to block children's access to inappropriate programs.
- **Closed Caption decoder**
Built-in Closed Caption decoder displays text for Closed Caption supported programs.
- **MTS / SAP tuner**
Audio can be selected from the remote control.
- **Auto Standby**
If there is no Input signal and no operation for 15 minutes, the unit will go into Standby mode automatically.
- **Sleep timer**
You can set the unit to go into Standby mode after a specific amount of time.
- **Choices for on-screen language**
Select your on-screen language: English, Spanish or French.
- **Stereo sound function**
- **PLL frequency synthesized tuning**
Provides free and easy channel selection and lets you tune directly to any channel using the number and decimal point ".•" buttons on the remote control.
- **Various adjustment for picture and sound**
Customizes image quality suitable for your room and sets your sound preference.
- **EasyLink via HDMI link**
EasyLink allows your other HDMI link devices to be controlled by the HDMI cable connected to your TV.
- **HDMI Input**
- **HDMI-DVI Input**
If your video device has DVI Output jack, use an HDMI-DVI conversion cable to connect the unit.
- **Component Video Input**
- **PC Input**
- **AV Input**
- **USB terminal**
The picture (JPEG) and video (Motion JPEG) files stored on a USB Memory Stick can be played back on this unit.
- **Digital Audio Output**
- **Headphone Audio Output**

Supplied accessories

User Manual

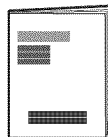

Quick Start guide



Remote Control and
batteries
(AAA, 1.5V × 2)

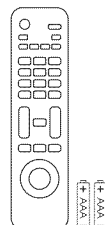

TV base and screws

50PFL3708 / 46PFL3708 / 40PFL4708 / 39PFL2708

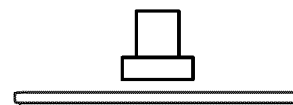

40PFL1708 / 32PFL3508



32PFL4508 / 29PFL4508 / 24PFL4508

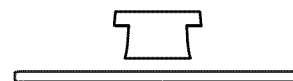

Screws packed with this unit.

Model	Quantity	Size
50PFL3708 / 46PFL3708	8	M4 × 0.472"(12mm)
40PFL4708 / 39PFL2708	3	M4 × 0.393"(10mm)
	4	M4 × 0.787"(20mm)
40PFL1708	3	M4 × 0.787"(20mm)
32PFL3508 / 32PFL4508 / 29PFL4508 / 24PFL4508	3	M4 × 0.984"(25mm)

Note

- If you lose the screws, please purchase the above-mentioned Phillips head screws at your local store.
- If you need to replace these accessories, please refer to the part name or No. with the illustrations and call our toll free customer support line found on the cover of this User Manual.

When using a universal remote control to operate this unit.

- Make sure the component code on your universal remote control is set to our brand. Refer to the instruction book accompanying your remote control for more details.
- We do not guarantee 100% interoperability with all universal remote controls.

Symbols used in this User Manual

The following is the description for the symbols used in this User Manual. Description refers to:

Digital TV operation

Analog/Cable TV operation

- If neither symbol appears, the operation is applicable to both.

Stand assembly

50PFL3708 / 46PFL3708 / 40PFL4708 / 39PFL2708

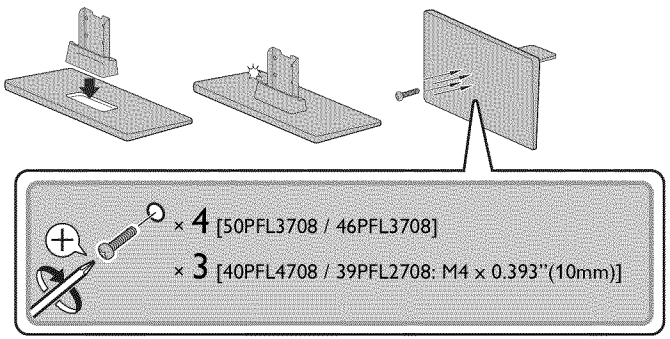

32PFL4508 / 29PFL4508 / 24PFL4508

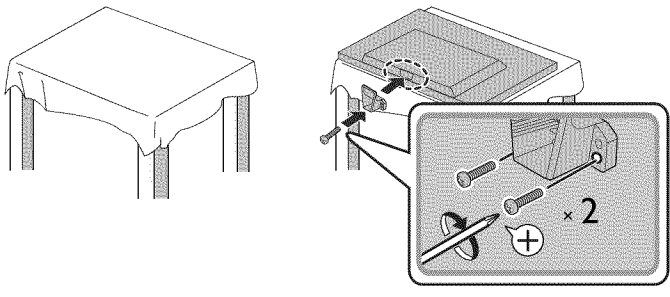

Attaching the base

You must attach the base to the unit to have it as a table top unit. Be sure the front and rear of the base match the proper direction. For large screen TVs, at least 2 people are required for these steps.

50PFL3708 / 46PFL3708 / 40PFL4708 / 39PFL2708

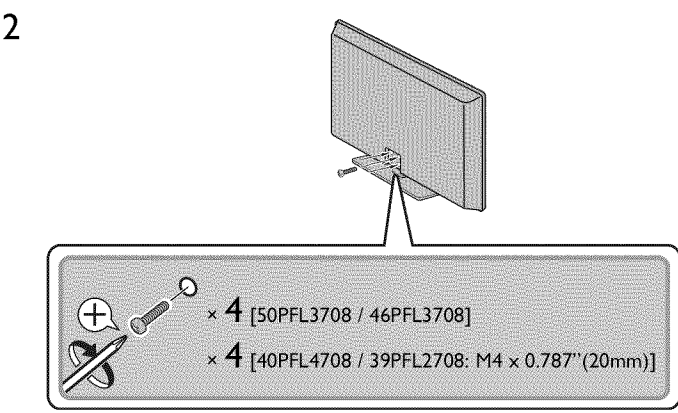
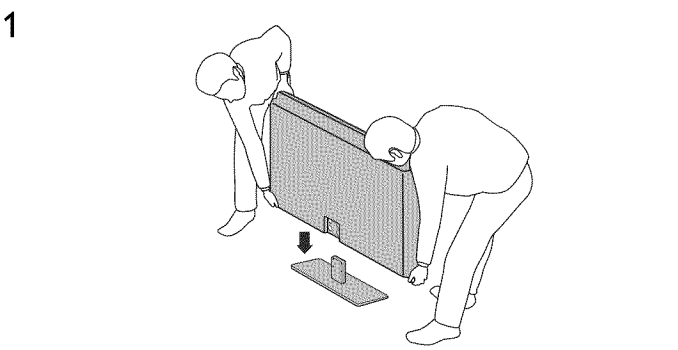

32PFL4508 / 29PFL4508 / 24PFL4508

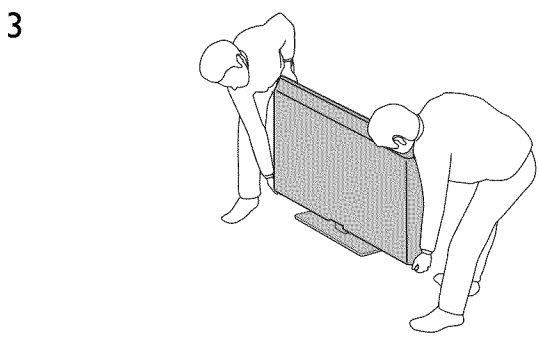
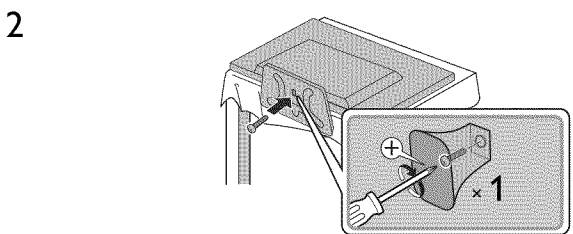
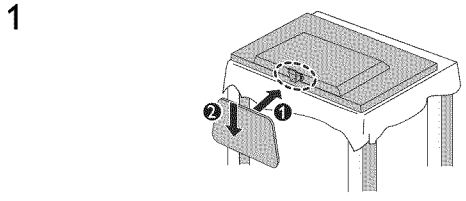

40PFL1708 / 32PFL3508

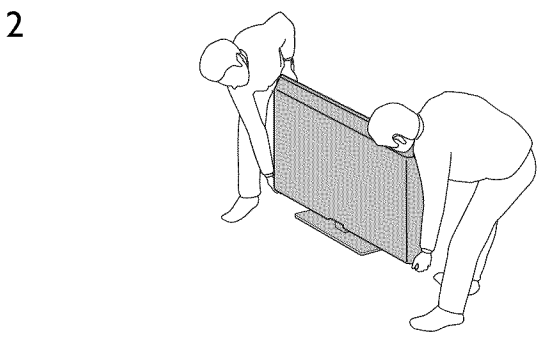
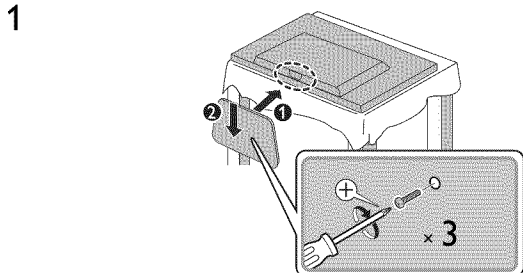

Note

- Make sure to use a table which can support the weight of this unit and is larger than this unit.
- Make sure the table is in a stable location.
- When attaching the base, ensure that "FRONT" with "arrow" written on the bottom of the base is downward. If it's not downward, the 2 hooks don't fit into the base.
- When attaching the base, ensure that all screws are tightly fastened. If the base is not properly attached, it could cause the unit to fall, resulting in injuries as well as damage to the unit.
- To remove the base from this unit, unscrew the Phillips head screws in step 2. Be careful not to drop the base when you remove it.

Managing cables

Route your antenna cable and all other cables through the cable management tie* at the back of the TV.

The holder helps keep your cables tidy and easily manageable.

- 1 Attach the cable management tie as illustrated below.

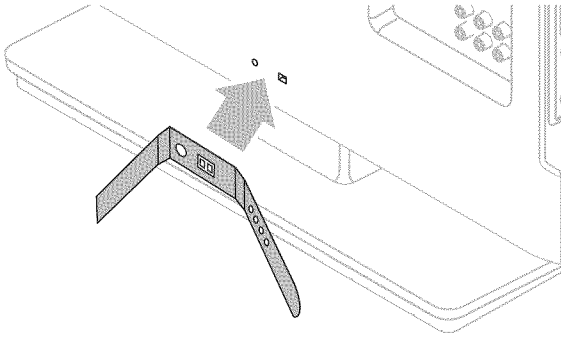

- 2 Pass cables through the cable management tie to avoid tangles.

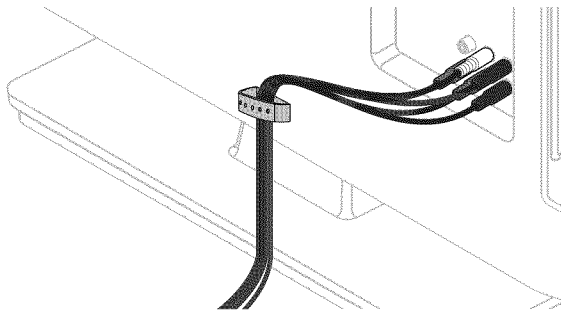

* The cable management tie is not supplied with your TV. If you would like this part, please call our toll free customer support line found on the cover of this User Manual, and it will be sent to you for free of charge.

Installing the remote control batteries

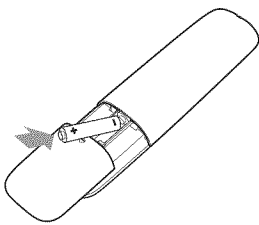

- 1 Slide the battery cover off the back of the remote control.
- 2 Insert the 2 supplied batteries (AAA, 1.5V). Be sure the + and - ends of the batteries line up with the markings inside the case.
- 3 Slide the cover back into position.

Note

- Remove the batteries if not using the remote control for an extended period of time.

Remote control

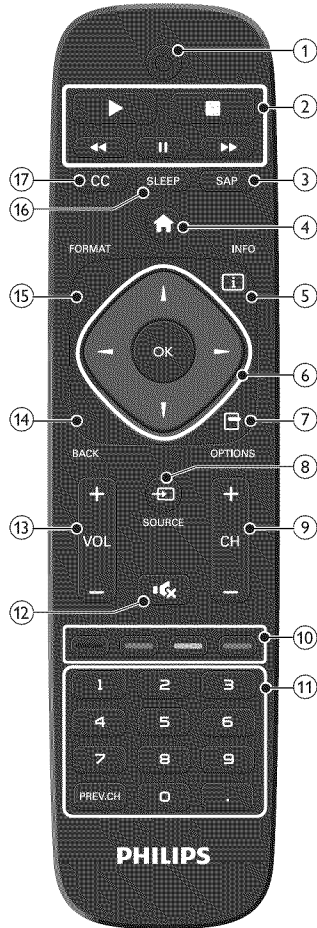

- ① **⏻ (POWER)**
Turns the TV On from Standby or Off to Standby.
 - ② **EasyLink(HDMI CEC) buttons**
 - ▶ Begins or Restarts the Disc playback.
 - ⏸ Pauses the Disc playback.
 - Stops the Disc playback.
 - ◀◀ / ▶▶ Searches Backward or Forward through the disc.
- Note**

 - You must set On in the **Master EasyLink** (→ p.30) to operate the above functions.
- ③ **SAP**
Selects Audio mode (MONO/STEREO/SAP) / Audio language.
 - ④ **🏠 (MENU)**
Displays the main menu.
 - ⑤ **INFO i**
Displays Information about the current program.
 - ⑥ **▲ ▼ ◀ ▶ (NAVIGATION buttons) / OK**
Moves the cursor; Selects the On-screen Menu items.
 - ⑦ **☰ OPTIONS**
Opens EasyLink options menu.
- Note**

 - You must set On in the **Master EasyLink** (→ p.30) to operate the above functions.
- ⑧ **📺 SOURCE**
Selects Connected devices.
 - ⑨ **CH + / -**
Selects a Channel.
 - ⑩ **COLOR buttons**
Use these Buttons according to the directions On-screen.
 - ⑪ **0 - 9 (NUMBER buttons)**
Used to enter a Channel / Program number.
 - **(DOT)** Use with 0-9 to select digital channels. For example, to enter 2.1, press
-
- PREV.CH** Returns to the previously viewed Channel.
- ⑫ **🔇 (MUTE)**
Turns the Sound On and Off.
 - ⑬ **VOL + / -**
Adjusts the Volume.
 - ⑭ **BACK**
Returns to the previous Menu operation.
 - ⑮ **FORMAT**
Adjusts the Picture size on the TV screen.
 - ⑯ **SLEEP**
Sets Sleep Timer.
 - ⑰ **CC**
Displays the audio portion of programming as text superimposed over the video.

Control panel

50PFL3708 / 46PFL3708

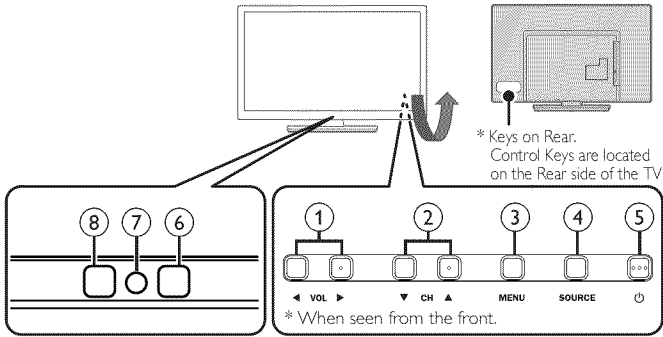

40PFL4708 / 32PFL4508 / 29PFL4508 / 24PFL4508

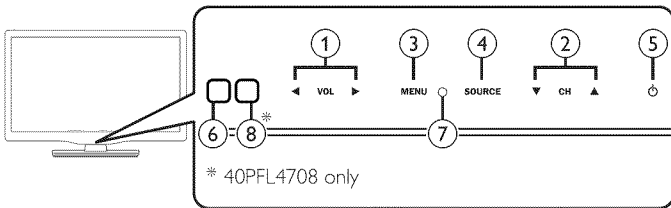

40PFL1708 / 39PFL2708 / 32PFL3508

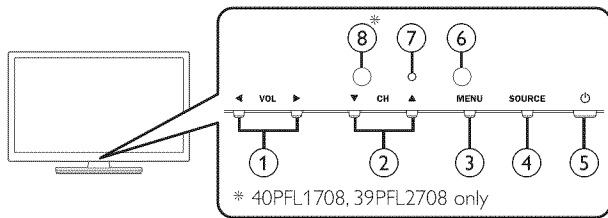

- ① **VOL ◀/▶**
Adjusts the Volume. In the Menu screen, moves the Cursor Left (◀) / Right (▶).
VOL ◀ : Volume Down
VOL ▶ : Volume Up
- ② **CH ▲/▼**
Selects a Channel. In the Menu screen, moves the Cursor Up (▲) /Down (▼).
- ③ **MENU**
Opens the Main On-screen Menu.
- ④ **SOURCE**
Selects Connected devices.
- ⑤ **⏻ (POWER)**
Turns the TV On and Off.
- ⑥ **Remote Control Sensor**
Receives IR signal from Remote control.
- ⑦ **Power On / Standby Indicator**
(On : lights in white, Standby : no light)
- ⑧ **Ambient Light Sensor**
Alters the brightness of the TV screen automatically by detecting your room lighting level. Do not block this Light Sensor window to allow proper operation.

Terminals

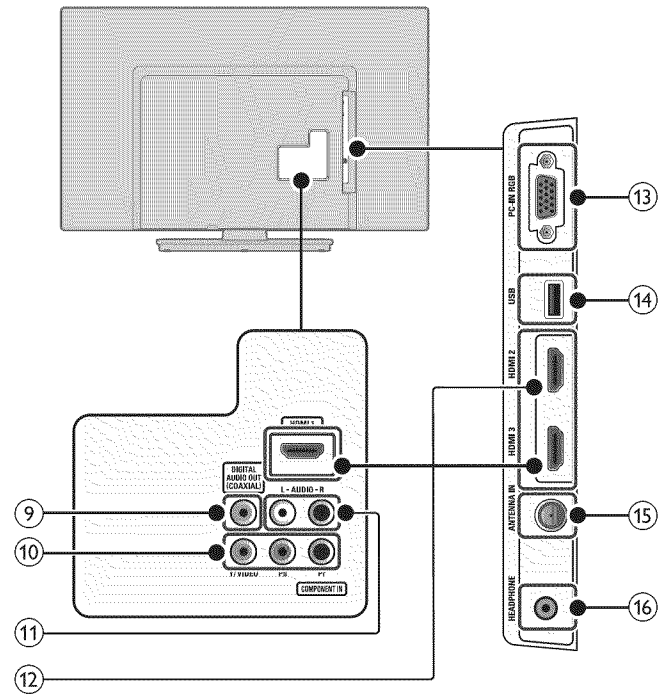

- ⑨ **Digital Audio Output jack**
Digital Audio (S/PDIF) Output to home theaters and other Digital Audio systems.
- ⑩ **Component (Y/Pb/Pr) / Composite Video (VIDEO) Input jacks for VIDEO**
Composite Video Input (VIDEO) jack is a shared jack with Component Video Input (Y) jack.
- ⑪ **Analog Audio (L/R) Input jacks**
Connect Analog Audio signals from;
– HDMI-DVI / Analog Audio (L/R) jacks signal
– Component Video / Analog Audio (L/R) jacks signal
– Composite Video / Analog Audio (L/R) jacks signal
– PC Connection / Analog Audio (L/R) jacks signal with Stereo mini 3.5mm plug Audio cable on PC
- ⑫ **HDMI Input jack(s)**
Digital audio and video Input from high definition Digital devices such as DVD / Blu-ray disc players, cable / satellite set-top boxes PC's.
- ⑬ **PC Input jack**
VGA cable connection for PC.
- ⑭ **USB terminal**
Data Input from USB Memory Stick only.
Do not connect any device to this terminal such as; Digital camera, keyboard, mouse, etc.
- ⑮ **75 ohm Cable / Antenna connection**
Signal Input from an antenna or cable / satellite set-top boxes.
- ⑯ **Headphone Audio Output jack**
Headphone 3.5mm stereo jack for personal listening.

Connecting the antenna or the cable

Be sure your antenna or other device is connected properly before plugging in the AC power cord.

If you connect to an antenna through RF cable

Any DTV programs that are broadcasted in your area can be received for free through an antenna connection.

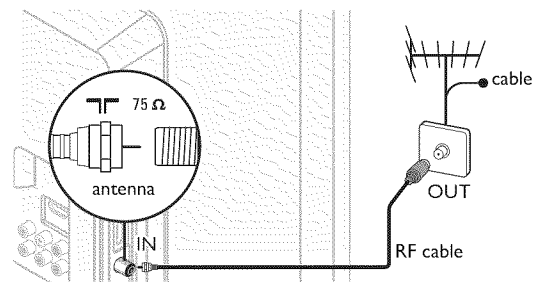

If you connect a set-top box through RF cable

If the TV is connected to a cable / satellite set-top box via a coaxial connection, set the TV to channel 3, 4 or the channel specified by the service provider.

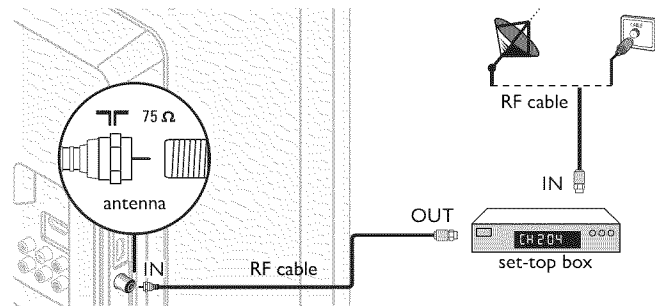

If you connect a set-top box through HDMI

If the TV is connected to a cable / satellite set-top box via HDMI, make sure you select the correct Source by using  SOURCE.

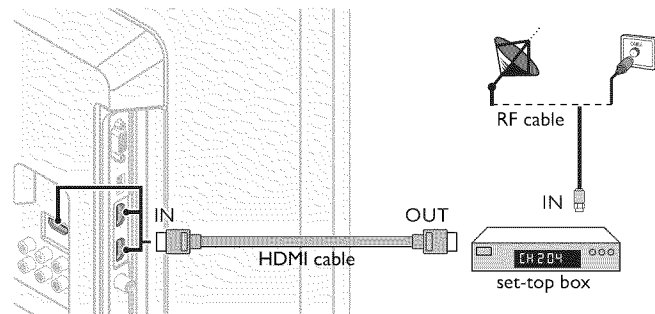

If you connect a set-top box through Component Video Input

If the TV is connected to a cable / satellite set-top box via Component Video Input, make sure you select the correct Component Video Source by using  SOURCE.

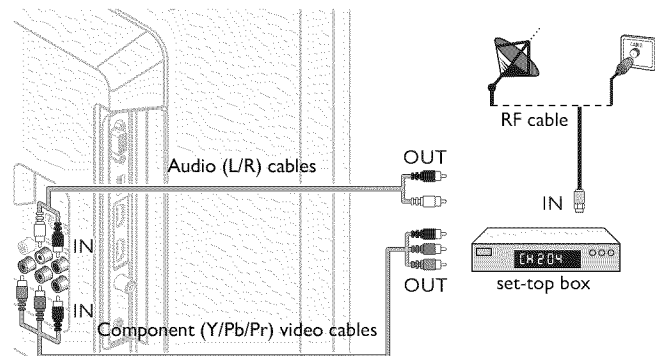

Connecting a set-top box, Blu-ray disc / DVD recorder via composite connectors and Analog Audio

Do not place your recorder too close to the screen because some recorders can be susceptible to signals.

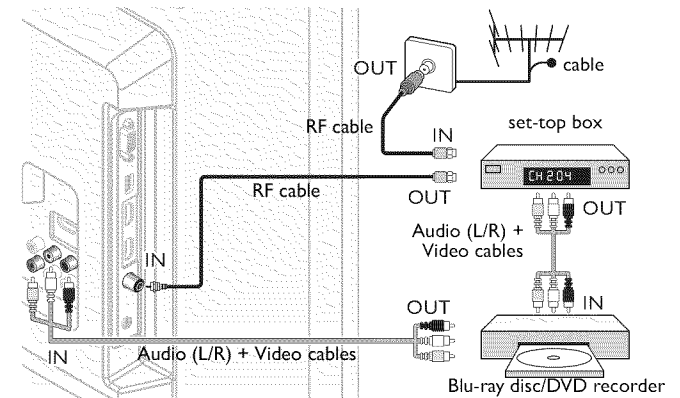

Note

- If you have any question about the DTV's antenna, visit www.antennaweb.org for further information.
- Depending on your antenna system, you may need different types of combiners (mixers) or separators (splitters) for HDTV signal. The minimum RF bandpass on these devices is 2,000MHz or 2GHz.
- For your safety and to avoid damage to this unit, please unplug the RF coaxial cable from the antenna Input jack before moving the unit.
- If you did use an antenna to receive Analog TV, it should also work for DTV reception. Outdoor or attic antennas will be more effective than a set-top box or inside antenna.
- To Turn On your reception source easily between antenna and cable, install an antenna selector.
- If you are not receiving a signal from your cable service, contact the Cable provider.
- Only the left loudspeaker reproduces sound for mono equipment. Use a mono to stereo adapter (not supplied) for sound reproduction via all internal loudspeakers.

Plugging in the AC power cord

Make sure that the AC power cord must be plugged to an AC outlet after all the necessary connections are made.

Caution

- Do not connect the AC power cord to a power supply outside the indicated voltage of this unit (AC 120V).
- Connecting the AC power cord to a power supply outside of this range may result in fire, smoke, unit failure or electrical shock.

Note

- Each time you plug in the AC power cord, no operations will be performed for a few seconds. This is not a malfunction.

No supplied cables are used with these connections:

- Please purchase the necessary cables at your local store.

Before you connect AC power cord:

Be sure other devices are connected properly before plugging in the AC power cord.

Selecting your connection quality

HDMI - Highest quality

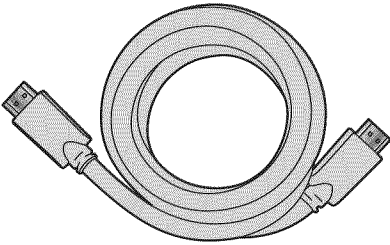

Supports high-definition Digital signals and gives highest picture and sound quality. Video and audio signals are combined in one cable. You must use HDMI for full high-definition video and to enable EasyLink (HDMI CEC).

Note

- Philips HDMI supports HDCP (High-bandwidth Digital Contents Protection). HDCP is a form of Digital Rights Management that protects high definition content in Blu-ray discs or DVDs.

Component (Y Pb Pr) - High quality

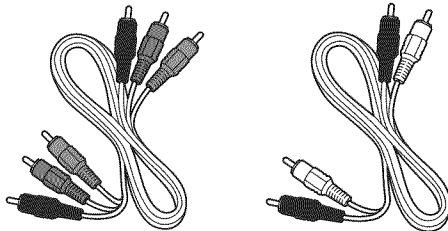

Supports high-definition Analog signals but gives lower picture quality than HDMI. Component (Y/Pb/Pr) Video cables combine red / green / blue video cables with red / white audio (L/R) cables. Match the cable colors when you connect to the TV.

Composite - Basic quality

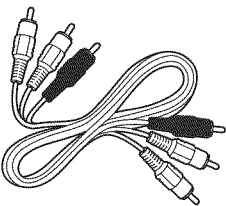

For analog connections. Composite Video / Audio Analog cable usually combine a yellow video cable with red / white audio (L/R) cables. With this unit, yellow cable must be connected to Y (green) jack of Component Video Input jacks.

Connecting your devices

HDMI Digital connection

HDMI connection offers the highest picture quality. HDMI (High-Definition Multimedia Interface) transports high definition Digital video and multi-channel Digital Audio through a single cable.

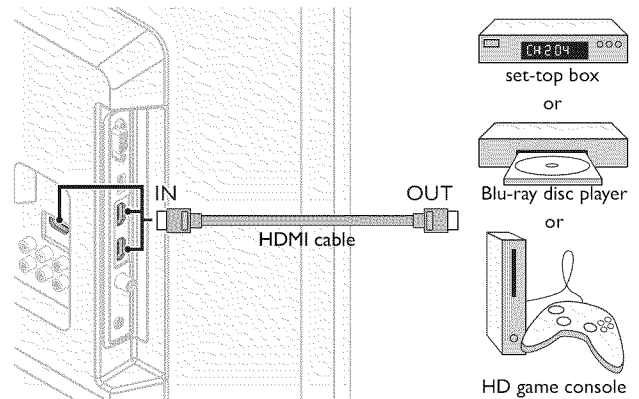

HDMI-DVI connection

This unit can be connected to your device that has a DVI terminal. Use an HDMI-DVI conversion cable for this connection and it requires audio cable for Analog Audio signal as well.

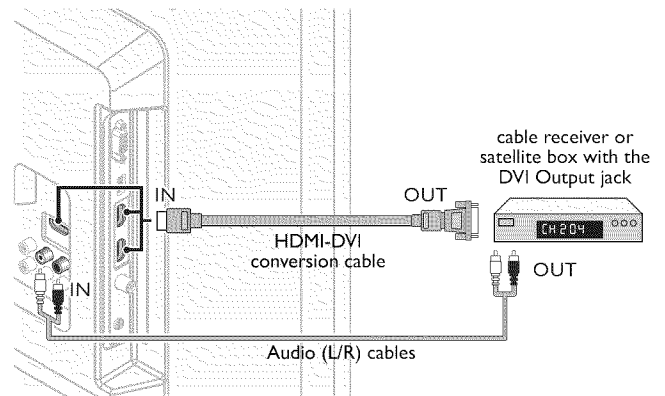

Note

- Use an HDMI cable with the HDMI logo (a certified HDMI cable). High Speed HDMI cable is recommended for the better compatibility.
- For HDMI connection**
- The unit accepts 480i / 480p / 720p / 1080i, 1080p 24/30/60Hz of video signals, 32kHz / 44.1kHz and 48kHz of audio signals.
 - This unit accepts 5.1 channel audio signal (Dolby Digital) and 2 channel audio signal (LPCM).
 - This unit accepts only signals in compliance with EIA861.
- For HDMI-DVI connection**
- The unit accepts 480i, 480p, 720p, 1080i and 1080p video signals.
 - HDMI-DVI connection requires separate audio connections as well and the audio signals are output as Analog (L/R) Audio.
 - DVI does not display 480i image which is not in compliance with EIA/CEA-861/861B.

Component Analog Video Connection

Component Analog Video connection offers better picture quality for video devices connected to the unit.

If you connect to the unit's Component Video (Y/Pb/Pr) Input jacks, connect Analog Audio cables to the Analog Audio (L/R) Input jacks.

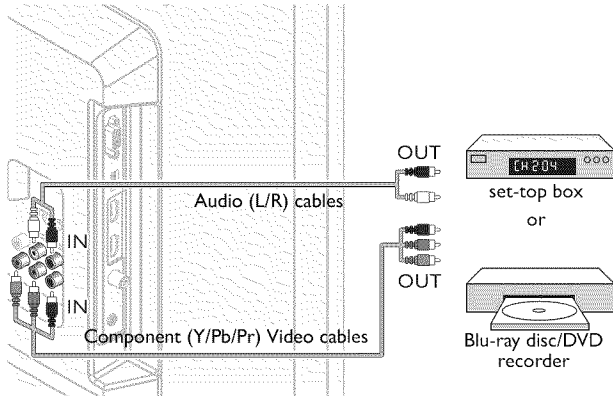

Note

- The unit accepts 480i / 480p / 720p and 1080i of video signals for this connection.

Digital Audio Output Connection

If you connect this unit to an external Digital Audio device, you can enjoy multi-channel audio like 5.1ch Digital broadcasting sound.

Use a Digital Audio coaxial cable to connect the unit to external Digital Audio devices.

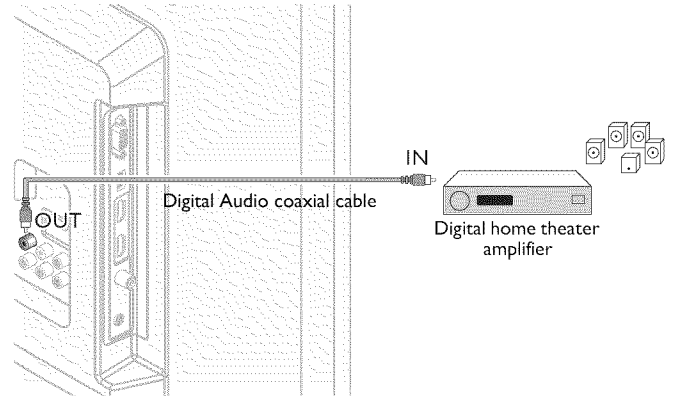

Composite Analog Video Connection

Composite Analog Video connection offers standard picture quality for video devices connected to the unit.

If you connect to the unit's Composite Video (Y/VIDEO) Input jack, connect audio cables to the Audio (L/R) Input jacks. When the Audio is monaural, then only connect to the Audio L Input jack.

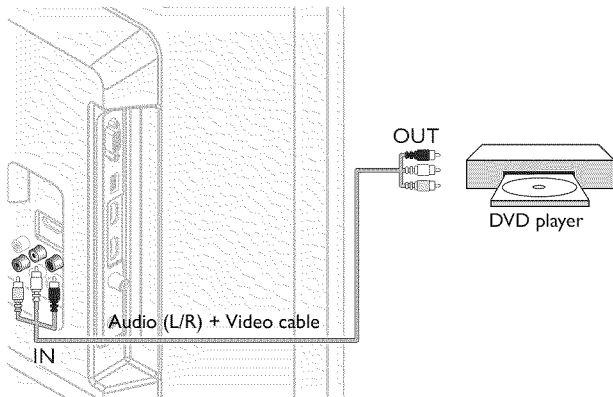

Note

- With this unit, yellow cable must be connected to Y (green) jack of Component Video Input jacks.
- Whenever you connect to the Composite Video Input jack (Y/VIDEO), you must disconnect the Component Video Input jacks (Pb and Pr). If you leave those jacks connected, it may cause of an unstable picture.
- Only the left loudspeaker reproduces sound for mono equipment. Use a mono to stereo adapter (not supplied) for sound reproduction via all internal loudspeakers.

PC connection

HDMI connection

This unit can be connected to your PC that has a HDMI terminal. Use an HDMI cable for this Digital connection.

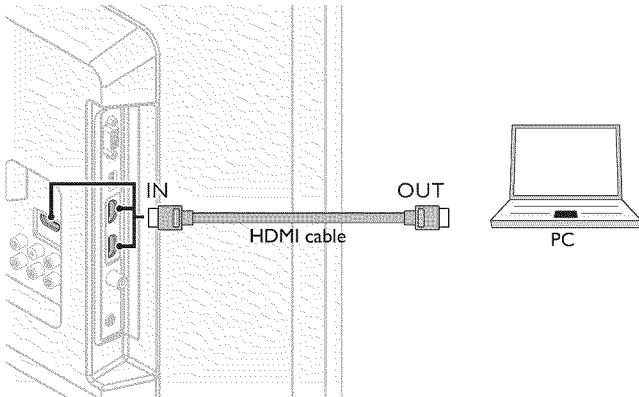

HDMI-DVI connection

This unit can be connected to your PC that has a DVI terminal. Use an HDMI-DVI conversion cable for this Video Digital connection and it requires Stereo mini 3.5mm plug Audio cable for Analog Audio signal as well.

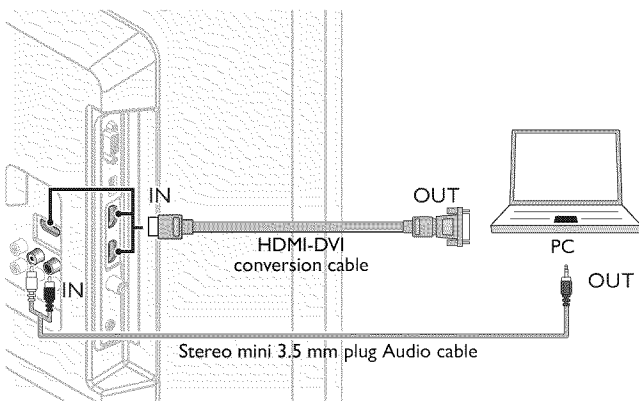

VGA connection

This unit is equipped with a PC Input jack. If you connect this unit to your PC, you can use this unit as a PC monitor. Use a VGA cable for this Video connection and it requires a Stereo mini 3.5mm plug Audio cable for Analog Audio signal as well.

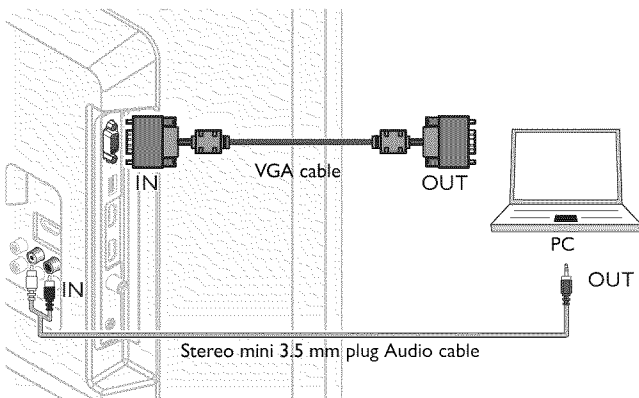

The following video signals can be displayed:

Format	Resolution	Refresh rate
VGA	640 × 480	60Hz
SVGA	800 × 600	
XGA	1,024 × 768	
WXGA	1,280 × 768	
	1,360 × 768	
FHD*	1,920 × 1,080	

Other formats or non-standard signals will not be displayed correctly.

* 50PFL3708 / 46PFL3708 / 40PFL4708 / 40PFL1708 / 39PFL2708 only.

Note

- Please purchase the VGA cable or HDMI-DVI conversion cable that has a ferrite core.
- The following operations may reduce noise.
 - Attach a ferrite core to the AC power cord of your PC.
 - Unplug the AC power cord and use the built-in battery of your PC.
- Use an HDMI cable with the HDMI logo (a certified HDMI cable). High Speed HDMI cable is recommended for the better compatibility.
- The unit accepts 480i, 480p, 720p, 1080i and 1080p video signals.
- HDMI-DVI connection requires separate audio connections as well and the audio signals are output as Analog (L/R) Audio.
- DVI does not display 480i image which is not in compliance with EIA/CEA-861/861B.

USB Memory Stick

This unit offers easy playback of picture (JPEG) and video (Motion JPEG) files.

Insert the USB Memory Stick into the USB terminal shown below.

USB → p.32

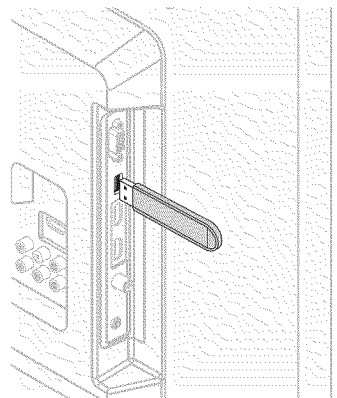

Note

- The unit recognizes only a USB Memory Stick.
- Do not use a USB hub or an extension cable to connect an external hard disk drive to the unit. (Not supported.)
- A USB Memory Stick is always inserted to this unit directly.
- A USB Memory Stick is not supplied with this unit.
- We do not guarantee that all USB Memory Sticks can be supported by this unit.
- Be sure to keep a backup copy of the original files on your device before you play them back on this unit. We have no responsibilities for damage or loss of your stored data.
- To protect your USB Memory Stick files from being erased place the write protect sliding tab in the protect position.
- When you are ready to remove a USB Memory Stick, set the unit to go into Standby mode to avoid any damage to your data and the unit.
- A USB Memory Stick that requires its own driver or the device with a special system such as fingerprint recognition are not supported.
- This unit is not allowed to use the USB Memory Stick which requires an external power supply (500mA or more).

*These operations are accessible by remote control.
Some may also be accessible by control panel on the main unit.*

Initial setup

This section will guide you through the unit's initial setting which includes selecting a language for your on-screen menu and autoprogram, which automatically scans and memorizes viewable channels.

Before you begin:

Make sure the unit is connected to antenna or cable.

- After making all the necessary connections, press to Turn On the unit.
 - It may take a few moments to Turn On the unit for the first time.
 - Initial setup** menu appears automatically after the unit is Turned On.
- Use to select the on-screen language from the choices (English / Español / Français) on the right side of the TV screen, then press **OK**.
- Use to select **Antenna** for TV channels or **Cable** for CATV channels, then press **OK**.

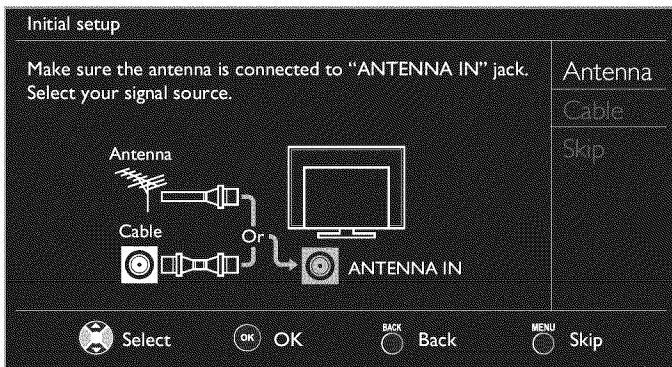

- When **Antenna** is selected, the TV detects antenna signals. It searches for DTV and Analog TV channels available in your area.
- When **Cable** is selected, the TV detects signals supplied by cable. It searches for DTV, Analog TV and Cable channels available in your area.
- Autoprogram** will begin.

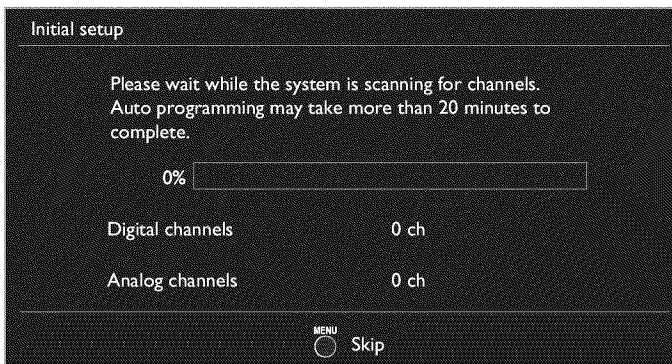

- Use to select the desired location setting, then press **OK**. **Home** is the ENERGY STAR[®] qualified setting.

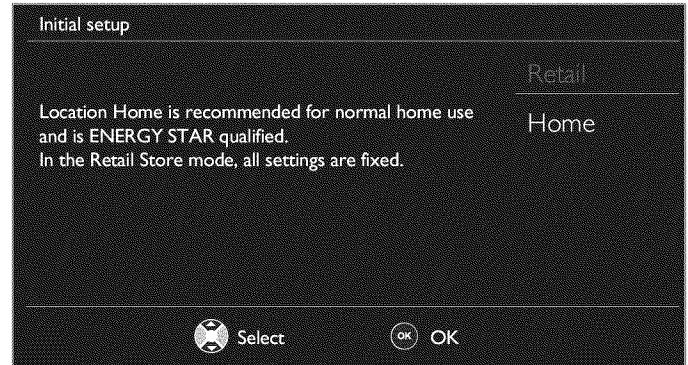

- Select **Retail**, the unit will be set up with predefined setting for retail displays. In this setting, the power consumption may possibly exceed the limited requirement limit of the ENERGY STAR[®] qualification.
- Select **Home**, the unit is set to maximize the energy efficiency for home setting and it can be adjusted through a choice of picture and sound quality according to your preference. Use this setting to remove the E-sticker if visible from the display. → p.31
- When the initial setup is completed, the lowest memorized channel with the confirmation message of the location setting will be displayed on the TV screen.

- When you select **Home**, press **OK** to begin **Settings assistant**.



- Press or 3 times to select the side of the pictures that is the most pleasing to you, then press **OK**.

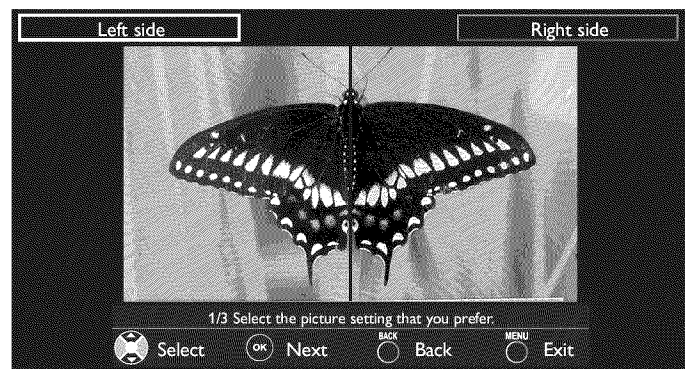

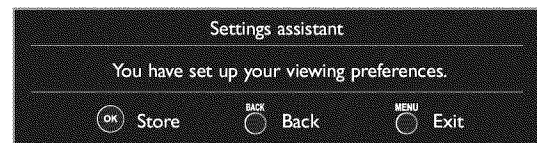

- Press **OK** to finish **Settings assistant**.



- When the initial setup is completed, the lowest memorized channel with the confirmation message of the location setting will be displayed on the TV screen.
- You must set **Home** in step 4. Otherwise, **Picture** and **Sound** settings you adjusted will not be memorized after the unit goes into Standby mode.

Continued on next page.

 Note

- If you are not receiving a signal from your cable service, contact the Cable provider.
- If you press  or  during autoprogram, this setup of TV channels will be cancelled.
- The initial autoprogram function can be executed for either **Antenna** or **Cable** only once. When you change the connection (Antenna / Cable), select **Autoprogram** again. → p.24
- If there is no signal Input from the antenna terminal and no operation for several seconds after you Turn On the unit, helpful hints appears. Follow the instructions listed on the TV screen.

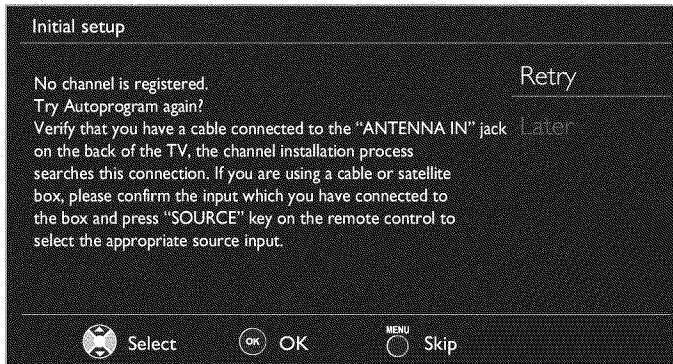

After an initial setup is completed...

- If you want to scan the channels automatically again.
Autoprogram → p.24
- You can add the desired cable and Analog channels unmemorized by autoprogram.
Add channels → p.25
- If you want to change to another language.
Language → p.31
- If you want to change the location setting.
Location → p.31
- If you want to restore the picture setting.
Settings assistant → p.23

4 Use your TV

Switching on your TV and putting it in Standby mode

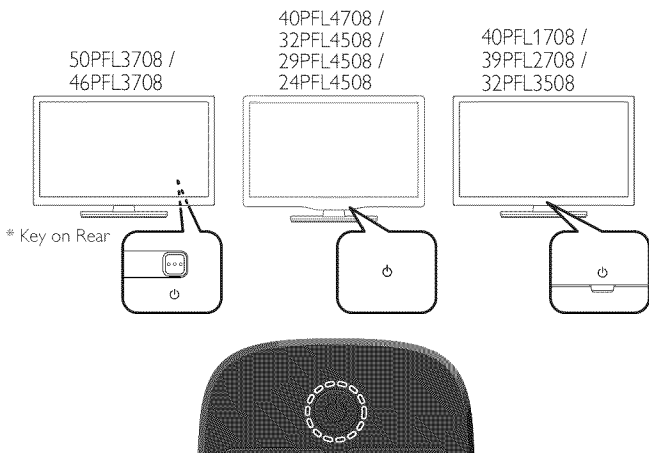

To Turn the TV On from Standby or Off to Standby

- Press (3 raised dots on the Rear panel or Front panel or the Remote control).

Note

- Energy consumption contributes to air and water pollution. When the AC power cord is plugged in, your TV consumes energy. Your TV has very low standby power consumption.

Adjusting volume

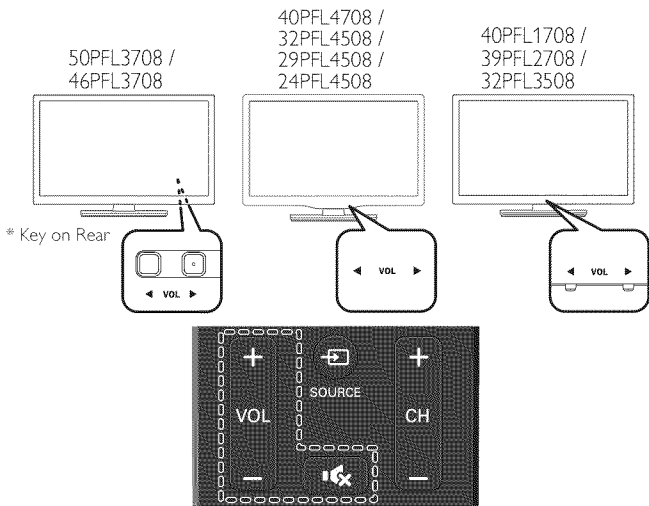

To decrease or increase volume

- Press / (1 raised dot on the Rear panel or Front panel) or press on the Remote control.
VOL : Volume Down
VOL : Volume Up

To mute or unmute sound

- Press on the remote control to mute the sound.
- Press again or to recover the original sound.

Switching channels

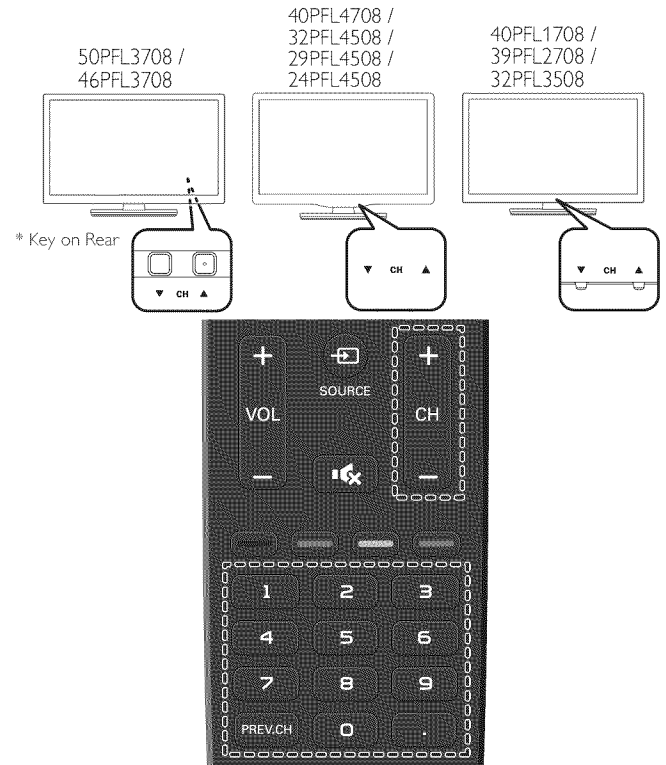

To select Channels by using CH / or CH + / -

- Press (Down) / (Up - 1 raised dot on the Rear panel or Front panel) or press on the Remote control.

To select Channels by using the NUMBER buttons

Digital TV operation

- For Digital channels, press a number followed by a dot “.” and the corresponding sub channel number.
- When selecting Digital channel 11.1
Be sure to press before entering the subchannel number.



Analog/Cable TV operation

- When selecting cable or Analog channel 11



Press to return to the previously viewed channel.

Note

- To select the non-memorized channels, use the **NUMBER** buttons.
- No Signal** will appear on the TV screen after the subchannel broadcast is over.
- Audio only program** message will appear on the TV screen, when you receive only sound signal.

* On the 46" & 50" TV's All CONTROL Keys are located on the Rear (lower right) side of the unit as viewed from the Front.

Watching channels from an external device

Switching Each Input Mode can easily switch with the remote control between TV (DTV or Analog TV) and external devices when they are connected to the unit.

- 1 Turn On a set-top box or the connected device.
 - The picture from your set-top box or the connected device might appear automatically on the TV screen.

If the picture does not appear

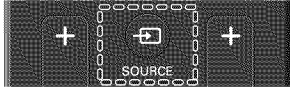

Press **SOURCE** repeatedly to select the set-top box or the connected device and wait a few seconds till the picture appears.

e.g.)

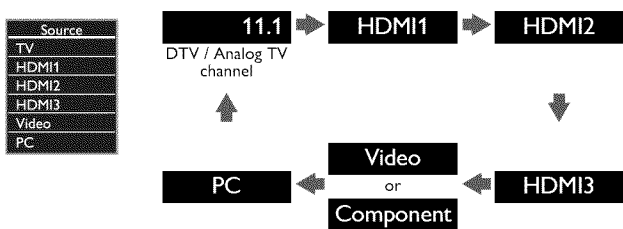

- Pressing **▲** reverses the direction of the Input modes.
- 2 Use the remote control of the set-top box or the connected device to select channels.

Sleep timer

Sleep Timer can set the unit to go into Standby mode after an incremental period of time.



Press **SLEEP** repeatedly to change the amount of time (increases the time by 30 minutes up to 120 minutes).



Press **SLEEP** once to call up the display for checking the remaining time.

- To cancel sleep timer; press **SLEEP** repeatedly until **Off** is displayed.

Switching audio mode



Digital TV operation

- 1 Press **SAP** to display the currently selected language and the number of available languages.

11.1
English 1/3
- 2 Press **SAP** repeatedly to cycle through the available audio languages.

Note

- Available languages differ depending on the broadcast.
- **Other** is displayed when the audio language cannot be acquired or the acquired languages are other than English, French or Spanish.

Analog/Cable TV operation

- 1 Press **SAP** to display the currently selected audio mode.
 - 2 While receiving an MTS broadcast, press repeatedly to cycle through the available audio channels.

11
SAP / STEREO
- e.g.) When all audio are available



STEREO : Outputs stereo-audio

SAP : Outputs second audio program

MONO : Outputs mono-audio

EasyLink options

If you have our brand products such as Blu-ray disc player or DVD recorder that are compatible with EasyLink functions, connect them to this unit via an HDMI cable so you can simply operate various items from this unit's remote control.



Before you begin:

You must set On in Device control and EasyLink control. → p.30
Otherwise, LINK does not work even if you connected our brand devices to this unit.

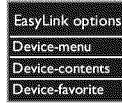
1 Press  **OPTIONS** to display EasyLink options menu.



Device-menu	Controls the menu of your connected EasyLink device.
Device-contents	Controls the top menu of your DVD or Blu-ray discs.
Device-favorite	Controls the pop-up menu of your Blu-ray discs.

2 Use   or **OK** on this unit's remote control to operate the desired functions for your devices.

Note

- Some of EasyLink functions may not be available depending on your EasyLink devices or discs.
- You must connect this unit to our brand EasyLink devices and be sure its EasyLink (HDMI CEC) setting is also set to On.
- We do not guarantee 100% interoperability with other brands of HDMI link compliant devices.

Changing picture format

Display modes can be selected when your TV receives a 16:9 or 4:3 video signal.

Three types of display modes can be selected for a PC Input signal.
Press **FORMAT** repeatedly to switch the TV aspect ratio.

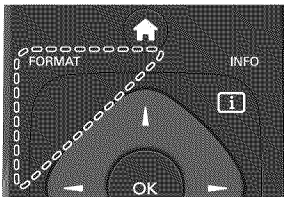

For 16:9 video signal

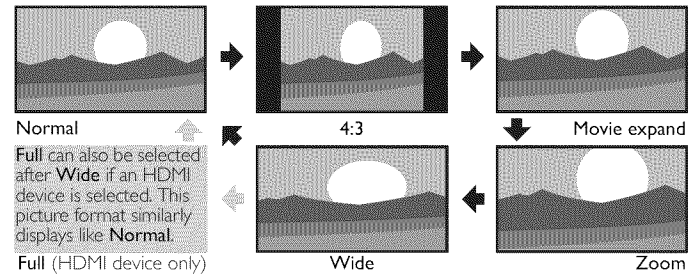

Normal	Original size.
4:3	Shortened horizontally. Sidebars appear on both edges of the screen.
Movie expand	Vertically stretched to fill the screen. This only crops out the top of the picture.
Zoom	Maximum size without changing its horizontal and vertical ratio.
Wide	Horizontally stretched picture. This crops out the left and right sides of the picture.

For 4:3 video signal

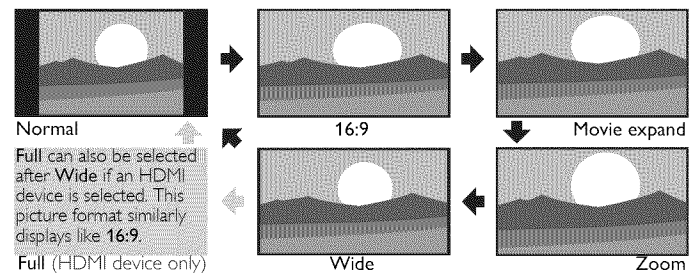

Normal	Original size. Sidebars appear on both edges of the screen.
16:9	Stretched horizontally to fill the screen.
Movie expand	Stretched more vertically at the top of the screen. This crops out the top of the picture.
Zoom	Maximum size that is more vertically stretched to fill the screen. This crops out the top and bottom of the picture.
Wide	Original size and the edges stretched horizontally to fill the screen.

For PC Input signal

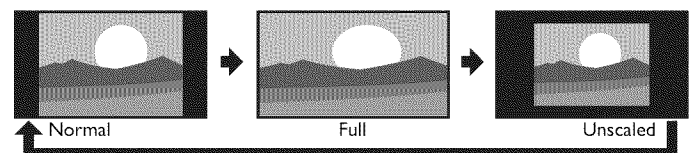

- This unit can also be connected to your PC that has a DVI terminal. Use an HDMI-DVI conversion cable for this Video connection and it requires Stereo mini 3.5mm plug Audio cable for Analog Audio signal as well.
- Refer to 16:9 video signal on this page if PC has HDMI Output.

Normal	Proportionately stretched picture. Sidebars appear on both edges of the screen.
Full	Stretched out of proportion to fill the screen.
Unscaled	Original size.

TV screen information

You can display the currently selected channel or other information such as the aspect ratio on the TV screen.

In the Digital mode, the detailed broadcasting information for the current off the air channel such as program title and program guides are displayed.

1 Press INFO .

Digital TV operation

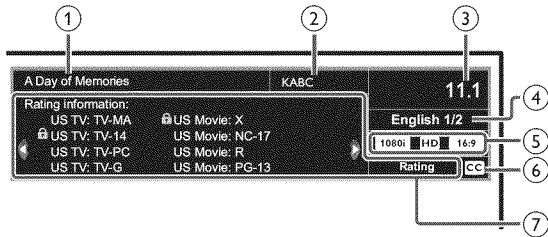

- ① Program title
- ② Broadcast station

Analog/Cable TV operation

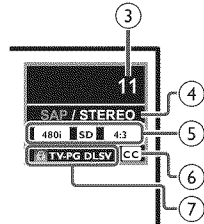

- ③ Channel number
Switching channels → p.18
- ④ Audio language (DTV) / audio mode (Analog TV)
Switching audio mode → p.19
- ⑤ Program's image aspect ratio
Changing picture format → p.20
- ⑥ CC (not available if Closed Caption is set to Off)
Caption settings → p.26
- ⑦ Child lock rating
Child and ratings lock → p.27

2 Press INFO  to hide the information.

Note

- When the program guide consists of more than 4 lines, use ▲▼ to scroll to the next / previous lines.
- **No description provided.** is displayed when the program guide is not provided.
- While the program guide is displayed, the Closed Caption function is interrupted.
- In external input mode, the following screen is displayed;
e.g.) When an external device is connected to Video Input jack.



- The information display will automatically disappear in 5 seconds.

5 Use more of your TV

This section describes the overview of the Main Menu displayed when you press .



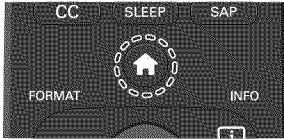

The Main Menu consists of the function setting items below.

Displaying the Main Menu

- 1 Press  to display the Main Menu.



Picture	Settings assistant	
Sound	Auto picture	Personal
Setup	Backlight	18
Features	Contrast	50
Language	Brightness	30
USB	Color	30
	Tint	0
	Sharpness	2
	Advanced settings	

- 2 Use   to select the desired Menu and an item, then press OK or use   to determine the setting.

Picture

→ p.23

Adjusting the Picture Mode or customize the Picture quality as your preference.

Sound

→ p.24

Adjusting the Sound Mode, Equalizer and some other Sound functions.

Setup

→ p.24

Scanning the Channels available in your area and see what the Antenna Signal levels are.

Features

→ p.26

Adjusting the Closed Caption, Parental Guide and some other useful functions.

Language

→ p.31

You can choose English, Spanish or French as your Onscreen Language.

USB

→ p.32

You can view Picture (JPEG) and Video (Motion JPEG) files stored on a USB Memory Stick.

- 3 When the Setting is completed, press  or BACK to exit.

Picture

Before you begin:

You must Set **Home** in **Location**. → p.31

Otherwise, personalized Picture and Sound settings will not be Memorized after the unit goes into Standby mode.

1 Press and use to select **Picture** then press **OK**.

Picture	Settings assistant	
Sound	Auto picture	Personal
Setup	Backlight	18
Features	Contrast	50
Language	Brightness	30
USB	Color	30
	Tint	0
	Sharpness	2
Advanced settings		

2 Use to select the item you want to adjust, then press **OK**.

Settings assistant	to guide you through the best picture setting	
Auto picture	to select the desired setting, then press OK (Personal, Standard, Vivid, Sports, Movie, Game and Eco) When you adjust the following settings, Personal picture will be set automatically.	
	Cursor	Cursor
Backlight	to reduce power consumption	to set the backlight brighter
Contrast	to decrease contrast	to increase contrast
Brightness	to decrease brightness	to increase brightness
Color	to decrease color intensity	to increase color intensity
Tint	to add red	to add green
Sharpness	to soften	to sharpen
Advanced settings	to select the desired setting, then press OK (Color alignment, Noise reduction, Active Control* ¹ , Ambient light sensor* ² , Black stretch, Dynamic contrast and Gamma)	

Note

- Adjusts backlight for the best picture quality by dynamically adjusting the backlight intensity in accordance with lighting condition in the room when **Active Control***¹ is set to **On**. Please ensure the room lighting is stable and the light sensor is not blocked.

*1 50PFL3708 / 46PFL3708 / 40PFL4708 only.

*2 40PFL1708 / 39PFL2708 only.

• You can set a particular Picture Quality using Advanced settings.

Picture	Color alignment	Normal
Sound	Noise reduction	On
Setup	*Active Control	On
Features	Black stretch	On
Language	Dynamic contrast	On
USB	Gamma	Gamma 2

Color alignment	Color temperature mode	to set the picture color temperature to Personal (Cool, Normal or Warm) When you adjust the following settings, Personal picture will be set automatically.	
		Cursor	Cursor
	Red gain	to decrease contrast with red	to increase contrast with red
	Green gain	to decrease contrast with green	to increase contrast with green
	Blue gain	to decrease contrast with blue	to increase contrast with blue
	Red offset	to decrease brightness with red	to increase brightness with red
	Green offset	to decrease brightness with green	to increase brightness with green
	Blue offset	to decrease brightness with blue	to increase brightness with blue
Noise reduction	Off	to set noise reduction to Off	
	On	to reduce noise in an image	
*Active Control	Off	to set Active Control to Off	
	Ambient On	to adjust backlight for the best picture quality by dynamically adjusting the backlight intensity in accordance with lighting condition in the room	
	Ambient Off	to adjust backlight for best picture quality based on the incoming video signal	
*Ambient light sensor	Off	to set ambient light sensor to Off	
	On	to alter the brightness of the TV screen automatically by detecting your room lighting level.	
Black stretch	Off	to set black stretch to Off	
	On	to enhance black color	
Dynamic contrast	Off	to set dynamic contrast to Off	
	On	to enhance contrast in an image automatically	
Gamma	Gamma 1	to change the gamma setting	
	Gamma 2		
	Gamma 3		

* This part differs depending on the product you have.

50PFL3708 46PFL3708 40PFL4708	40PFL1708 39PFL2708	32PFL3508 32PFL4508 29PFL4508 24PFL4508
Active Control	Ambient light sensor	-

Sound

Before you begin:

You must set **Home** in **Location**. → p.31

Otherwise, personalized Picture and Sound settings will not be memorized after the unit goes into Standby mode.

1 Press **Home** and use **▲▼** to select **Sound**, then press **OK**.

Picture	Auto sound	Standard
Sound	Equalizer	
Setup	*SRS TruSurround XT	On
Features	Auto volume leveling	Off
Language	TV speakers	On
USB	Digital output format	Multichannel
	Audio setting	Stereo

2 Use **▲▼◀▶** to select the item you want to adjust, then press **OK**.

Auto sound	to select the desired setting, then press OK . (Personal, Standard, Vivid, Sports, Movie, Music and News) When you adjust the following settings (Equalizer, SRS TruSurround XT*, Incredible Surround* and Auto volume leveling), Personal sound will be set automatically.
------------	--

Adjust the tonal quality for each frequency.

Equalizer	Cursor ◀	Cursor ▶
	to adjust each level of tonal quality Press BACK to go back to the previous menu.	

This selects sound modes for more spatial or surround sound reproduction.

*SRS TruSurround XT	Off	to set SRS TruSurround XT® to Off
	On	to set SRS TruSurround XT® to On

Incredible Surround gives you the stereophonic virtual space through your existing 2-channel stereo system.

*Incredible Surround	Off	Natural effect.
	On	Emphasized effect.

* This part differs depending on the product you have.

- SRS TruSurround XT for 40PFL4708, 39PFL2708, 32PFL3508, 32PFL4508, 29PFL4508, 24PFL4508.
- Incredible Surround for 50PFL3708, 46PFL3708, 40PFL1708.

This function keeps a constant loudness differential between the TV commercials and the programs.

Auto volume leveling	Off	to remove the auto volume leveling
	On	to reduce volume differences between the TV commercials and the programs

You can select the Audio Output from the unit's speakers or not. If your amplifier is HDMI link function compatible and connected by an HDMI cable to this unit, some sound operations such as volume up can be changed by using this unit's remote control.

TV speakers	On	to output sound from the unit's speakers
	Off	not to output sound from the unit's speakers
	Speakers EasyLink	to control Audio Output from your connected EasyLink Compliant Devices with VOL + / - by using this unit's remote control.

You can select audio output through a digital audio output connector.

Digital output format	Multichannel	to output multichannel signals. (When the audio of the content is PCM, it will be output in PCM even if Multichannel is selected.)
	PCM	to output PCM signals.

You can set the output mode as a default for the sound mode (Analog TV only).

This setting is not interlocked when you change the output mode by pressing **SAP**. Refer to **Switching audio mode**. → p.19

Audio setting	Stereo	to output stereo-audio
	Mono	to output mono-audio
	SAP	to output second audio program

Setup

Before you begin:

Make sure the unit is connected to antenna or cable.

1 Press **Home** and use **▲▼** to select **Setup**, then press **OK**.

Picture	Autoprogram
Sound	Channel list
Setup	Add channels
Features	Antenna
Language	
USB	

2 Adjust the following items.

Autoprogram

Be sure the RF cable is correctly connected to this unit and you are registered with your cable TV provider when you install Cable channels.

1 Use **▲▼** to select **Autoprogram**, then press **OK**.

- If you run **Autoprogram** when you have locked channels, a message appears asking to enter your PIN. Enter your PIN in order to complete the installation. You need to set the channel lock again after the installation.

2 Use **▲▼** to select an appropriate option, then press **OK**.

- When **Antenna** is selected, the TV detects any off-the-air antenna signals. It searches for ATSC (Digital) and NTSC (Analog) channels available in your area.
- When **Cable** is selected, the TV detects signals supplied by cable. It searches for DTV, Analog TV and Cable channels available in your area.

Picture	Autoprogram will rescan all channels.	Back
Sound	Auto programming may take more than 20 minutes to complete.	Antenna
Setup		Cable
Features	Select your signal source.	
Language	Antenna	
USB	Cable	

Continued on next page.

- When the scanning and memorizing channels are completed, the lowest memorized channel will be displayed.

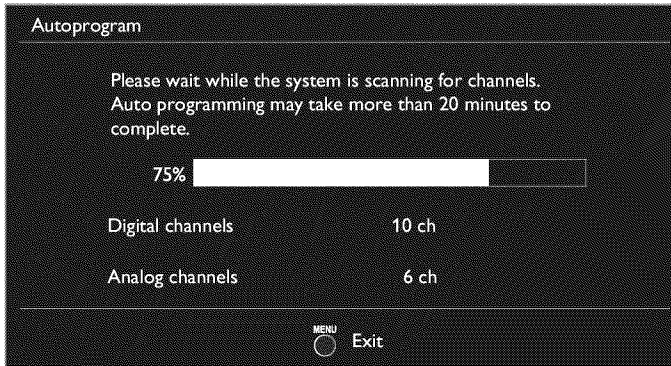

Note

- After setting **Autoprogram**, using **CH + / -** skips unavailable programs automatically.
- If you are not receiving a signal from your cable service, contact the Cable provider.
- If you press **Power** or **Home** during autoprogram, the setup of TV channels will be cancelled.
- Even if **Autoprogram** is completed, the channel setting will be lost if the AC power cord is unplugged before the unit goes into Standby mode by pressing **Power**.
- The PIN Code will be required once you set a PIN code in the **Child and ratings lock**. → p.27
- If you want to change your PIN code, follow the instruction of **Change PIN**. → p.29

Add channels

This function lets you add the off the air Analog TV or Analog Cable channels that were not added by the autoprogram due to reception conditions during the initial setting.

- Use **▲▼** to select **Add channels**, then press **OK**.
- Use the **NUMBER** buttons to enter the number of the channel you want to add, then press **OK**.

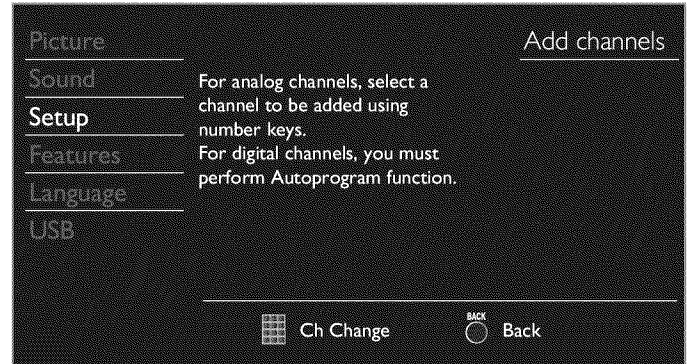

Note

- If setup completes successfully, **Added to the channel list** is displayed.
- If external Input is used, it is not possible to register the channel and **Unavailable** will be displayed on the TV screen.
- Some channels cannot be selected by **CH + / -**. Use the **NUMBER** buttons to select the memorized channels.

Channel list

The channels selected here can be skipped when selecting the channels using **CH + / -**.

Those channels can still be selected with the **NUMBER** buttons.

- Use **▲▼** to select **Channel list**, then press **OK**.
- Use **▲▼** to select the channel you want to remove, then press **OK**.



- The channel display for the removed channel darkens. You will not be able to select the channel again using **CH + / -**.
- To reactivate a removed channel, use **▲▼** and press **OK**. The registered channels are highlighted.
- When you remove a main channel, its subchannels are removed as well.

Note

- The channel with **DTV** indicated on the display is ATSC. Otherwise the channel is Analog TV (NTSC).

Antenna confirmation

Digital TV operation

This function lets you check the Digital signal strength of each channel.

- Use **▲▼** to select **Antenna**, then press **OK**.
- Use the **NUMBER** buttons or **CH + / -** to select the channel for which you want to check the Digital signal strength.

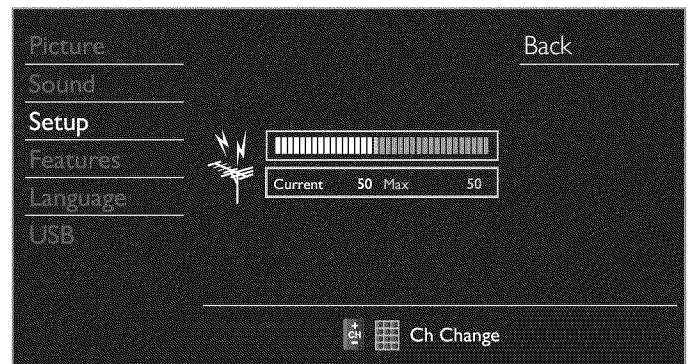

Note

- If the channel is set to Analog channel or external Input, you cannot confirm the antenna condition.

Features

- 1 Press and use to select **Features**, then press **OK**.

Picture	Caption settings	
Sound	Child lock	
Setup	PC settings	
Features	EasyLink	
Language	Location	Home
USB	E-sticker	
	Software upgrade	

- 2 Adjust the following items.

Caption settings

Closed Captioning displays the audio portion of programming as text superimposed over the video.

- 1 Use to select **Caption settings**, then press **OK**.

Picture	Closed Caption	Off
Sound	Caption service	CC-1
Setup	Digital caption service	CS-1
Features	Caption style	
Language		
USB		

- 2 Use to select the item you want to adjust, then press **OK**.

You can choose the closed caption display.

Closed Caption	Off	Closed caption is not displayed.
	On	Closed caption is always displayed.
	CC w/ mute	Closed caption is displayed when the sound is off.

Note

- You can cycle through the **Closed Caption** settings by pressing **CC**.

Digital TV operation

In addition to the basic Closed Caption, DTV has its own Closed Caption called Digital caption service. Use this menu to change the settings for Digital caption service.

Digital caption service	CS-1 to CS-6	Selects one of these before changing any other item in Caption settings menu. Choose CS-1 under normal circumstances.
-------------------------	--------------	---

Analog/Cable TV operation

Caption service	CC-1 and T-1	The primary caption and text services. The captioning or text is displayed in the same language as the program's dialog (up to 4 lines of script on the TV screen).
	CC-3 and T-3	Serve as the preferred data channels. The captioning or text is often a secondary language.
	CC-2, CC-4, T-2 and T-4	Rarely available and broadcasters use them only in special conditions, such as when CC-1 and CC-3 or T-1 and T-3 are not available.

- There are 3 display modes according to programs:

Paint-on	Displays input characters on the TV screen immediately.
Pop-on	Once characters are stored in memory, they are displayed all at once.
Roll-up	Displays the characters continuously by scrolling (max. 4 lines).

You can choose the size, font, color, background and other characteristics of the caption text.

Caption style	Font	Font style	Closed Captioning font style, size, color and transparency can be changed.
		Font size	
		Font color	
		Font opacity	
	Background	Background color	Background color and transparency of the displayed caption can be switched.
		Background opacity	
Edge	Edge color	Edge color and type of the displayed caption can be switched.	
	Edge type		

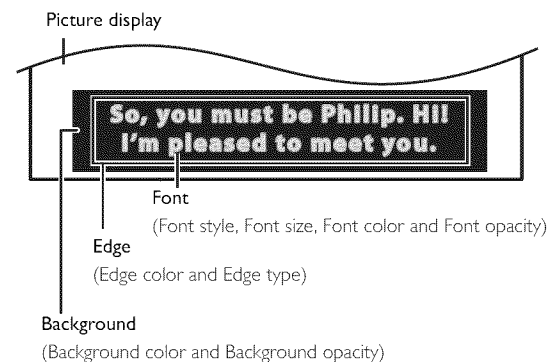

- Review your setting choice made below by looking in the upper right corner of the displayed setting box (not all selections show the differences selected).

Continued on next page.

Note

- **Digital caption service** that you can switch differs depending on the broadcast description.
- Caption style will not effect if the User setting is set to Off.
- Closed Captioning service may not be controlled by this unit's menu options if you are watching television through an external cable or satellite set-top box. In which case you will need to use the menu options on the external set-top box to control Closed Captioning.
- The captions do not always use correct spelling and grammar.
- Not all TV programs and product commercials include Closed Caption information. Refer to your area TV program listings for the TV channels and times of Closed Caption shows. The captioned programs are usually noted in the TV listings with service marks such as **CC**.
- Not all captioning services are used by a TV channel during the transmission of a Closed Caption program.
- Closed Caption will NOT be displayed when you are using an HDMI connection.
- To show the Closed Caption on your TV screen, broadcast signal must contain the Closed Caption data.
- Not all TV programs and commercials have the Closed Caption or all types of the Closed Caption.
- Captions and texts may not exactly match the TV voice.
- Changing channels may delay the Closed Caption for a few seconds.
- Adjusting or muting the volume may delay the Closed Caption for a few seconds.
- Abbreviations, symbols and other grammatical shortcuts may be used in order to keep pace with the on-screen action. This is not a malfunction.
- The caption or text characters will not be displayed while the main menu or functions display is shown.
- If a black box appears on the TV screen, this means that the Closed Caption is set to the text mode. To clear the box, select **CC-1**, **CC-2**, **CC-3** or **CC-4**.
- If the unit receives poor quality television signals, the captions may contain errors or there might be no captions at all. Some possible causes of poor quality signals are:
 - Automobile ignition noise
 - Electric motor noise
 - Weak signal reception
 - Multiplex signal reception (ghosts or screen flutter)
 - Data dropout and Pixelation (for DTV only)
- The unit retains the Closed Caption setting if the power fails.
- When the unit receives special effects playback signal (e.g. Search, Slow and Still) from a VCR's video Output channel (ch3 or ch4), the unit may not display the correct caption or text.
- The EUT setting that satisfies § 79.102 (e) is as follows:
Font: Mono-font
Character size: Large

See the following description for setting each item.

Picture	Channel lock
Sound	US movie ratings lock
Setup	US TV ratings lock
Features	Canadian English rating
Language	Canadian French rating
USB	Region ratings lock Change PIN

Note

- When you select a rating and set it to or , the higher ratings will be blocked automatically. The lower ratings will be available for viewing.
- When you set the highest rating to , all ratings turn to automatically.
- To block any inappropriate programs, set your limits in **US movie ratings lock**, **US TV ratings lock** and **Region ratings lock**.
- The child lock setting will be retained after a power failure or after the power is removed for longer than 10 seconds (except the PIN code reverts to 0000).
Child and ratings lock → p.27
- **Region ratings lock** and **Clear region ratings lock** will be available when the unit receives a Digital broadcast using the new rating system.
- For the United States, the unit may download the Region Ratings Lock Table, if required.
- The Canadian rating systems on this unit are based on CEA-766-A and CRTC policy.

Channel lock

Particular channels or external Input modes can be invisible in this function.

- Use **▲▼** to select **Channel lock**, then press **OK**.
- Use **▲▼** to select the particular channels or external Input, then press **OK** repeatedly to switch between view and block.
 - indicates that the channel or Input Source is locked.
 - indicates that the channel or Input Source is not locked.

Picture	<input type="checkbox"/> HDMI1
Sound	<input type="checkbox"/> HDMI2
Setup	<input type="checkbox"/> HDMI3
Features	<input type="checkbox"/> Video
Language	<input type="checkbox"/> PC
USB	<input type="checkbox"/> 40.1 DTV <input checked="" type="checkbox"/> 40.2 DTV

Child and ratings lock

You can prevent your children from watching certain programs or certain channels by locking the TV controls and by using ratings.

- Use **▲▼** to select **Child lock**, then press **OK**.

Picture	Caption settings
Sound	Child lock
Setup	PC settings
Features	EasyLink
Language	Location Home
USB	E-sticker Software upgrade

- Use the **NUMBER** buttons to enter the 4-digit numbers for your PIN code.
 - When you have not set up your PIN code, enter **0, 0, 0, 0**.
 - When the PIN code is correct, **Child lock** menu is displayed.

Setting US movie and TV ratings

US movie ratings lock is the rating system created by MPAA. US TV ratings lock has controlled access to individual programs based on their age ratings and content rating.

- 3 Use ▲▼ to select **US movie ratings lock** or **US TV ratings lock**, then press OK.
- 4 Use ▲▼ to select the desired rating, then press OK repeatedly to switch between view and block.
 - For US TV ratings, you can further set the sub ratings to block specific elements of programming.
 - ☒ or ☑ indicates that the rating is locked.
 - ☐ indicates that the rating is not locked.

US movie ratings lock

Picture	<input type="checkbox"/> All
Sound	<input checked="" type="checkbox"/> NR
Setup	<input type="checkbox"/> G
Features	<input type="checkbox"/> PG
Language	<input type="checkbox"/> PG-13
USB	<input type="checkbox"/> R
	<input type="checkbox"/> NC-17
	<input type="checkbox"/> X

US TV ratings lock

Picture	<input type="checkbox"/> All
Sound	<input checked="" type="checkbox"/> None
Setup	<input type="checkbox"/> TV-Y
Features	<input type="checkbox"/> TV-Y7
Language	<input type="checkbox"/> TV-G
USB	<input type="checkbox"/> TV-PG
	<input type="checkbox"/> TV-14
	<input type="checkbox"/> TV-MA

To set the sub ratings

As for **TV-Y7**, **TV-PG**, **TV-14** or **TV-MA**, you can further set the sub ratings to block specific elements of programming. To set the sub ratings, follow the step below.

Use ▲▼◀▶ to select the desired rating, then press OK repeatedly to switch between ☒ and ☐.

Picture	<input type="checkbox"/> All	<input checked="" type="checkbox"/> (FV) Fantasy Violence
Sound	<input type="checkbox"/> None	
Setup	<input type="checkbox"/> TV-Y	
Features	<input checked="" type="checkbox"/> TV-Y7	
Language	<input type="checkbox"/> TV-G	
USB	<input type="checkbox"/> TV-PG	
	<input type="checkbox"/> TV-14	
	<input type="checkbox"/> TV-MA	

US TV ratings	Sub Rating
TV-Y7	(FV) Fantasy Violence
TV-PG	(D) Dialog (L) Language (S) Sex (V) Violence
TV-14	(L) Language (S) Sex (V) Violence
TV-MA	(L) Language (S) Sex (V) Violence

Note

- Blocked sub rating will appear beside the main rating category in **US TV ratings lock** menu.
- You cannot block a sub rating if the main rating is set to ☐.
- Changing the category to ☒ or ☐ automatically changes all its sub ratings to the same (☒ or ☐).

US movie ratings	US TV ratings	Description
All		All ratings locked including no rating
NR	None	No rating
-	TV-Y	Appropriate for all children
-	TV-Y7	Appropriate for all children 7 and older
G	TV-G	General audience
PG	TV-PG	Parental guidance suggested
PG-13	-	Unsuitable for children under 13
-	TV-14	Unsuitable for children under 14
R	-	Restricted under 17 requires accompanying parent or adult guardian
NC-17	-	No one under 17 admitted
X	TV-MA	Mature audience only

Canadian English or Canadian French ratings

You can select the rating for Canadian English or Canadian French broadcasting.

- 3 Use ▲▼ to select **Canadian English rating** or **Canadian French rating**, then press OK.
- 4 Use ▲▼ to select the desired rating, then press OK repeatedly to switch between view and block.
 - indicates that the rating is locked.
 - indicates that the rating is not locked.

Canadian English rating	Canadian French rating	Description
All		Locked all ratings
E		Exempt program
C	—	For all children
C8+	—	For children over 8
G		General audience
—	8ans+	Unsuitable for ages under 8
PG	—	Parental guidance suggested
—	13ans+	Unsuitable for ages under 13
14+	—	Unsuitable for ages under 14
—	16ans+	Unsuitable for ages under 16
18+	18ans+	Adult audience only

Note

- The V-Chip can block non rated programs as per "CEA-608-E sec. L3". If the option to block NR, None or E programs is used in **US movie ratings lock**, **US TV ratings lock**, **Canadian English rating** or **Canadian French rating** accordingly "unusual results may occur and the unit may not receive emergency bulletins or other types of programming": / Emergency Bulletins (Such as EAS messages, weather warnings and others) / Locally originated programming / News / Political / Public Service Announcements / Religious / Sports / Weather.

Change PIN

Although the default PIN code (0000) is supplied with the unit, you can set your own PIN code.

- 3 Use ▲▼ to select **Change PIN**, then press OK.
- 4 Press the **NUMBER buttons** to enter the new 4-digit PIN code.
 - Enter PIN code again in **Confirm PIN**. entry field.

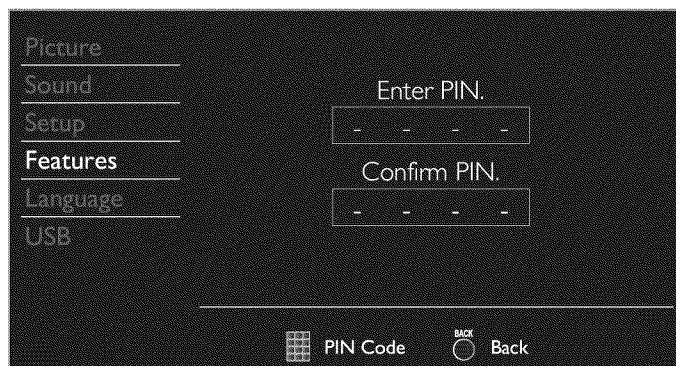

Note

- Make sure new PIN code and confirm PIN code must be exactly the same. If they are different, the space is cleared for reentering.
- Your PIN code will be erased and returns to the default PIN code (0000) when a power failure occurs.
- If you forget the PIN code, unplug the AC power cord then wait for 10 seconds to plug the AC power cord in again. The unit will restore the PIN code to 0000 as the factory default.

PC settings

This function lets you adjust the PC screen position, clock and phase during PC Input.

Use ◀▶ to adjust **Clock** setting to stabilize the PC screen and **Phase** setting to improve the clarity of the PC screen.

- 1 Use ▲▼ to select **PC settings**, then press OK.

Picture	Auto adjustment	
Sound		
Setup	Horizontal position	0
Features	Vertical position	0
Language	Clock	0
USB	Phase	0

- 2 Use ▲▼ to select the item you want to adjust, then press OK.
 - The horizontal/vertical position, clock and phase of the PC screen are automatically adjusted.

Auto adjustment	Select if you want to adjust automatically.	
	Cursor ◀	Cursor ▶
Horizontal position	to move PC screen left	to move PC screen right
Vertical position	to move PC screen down	to move PC screen up
Clock		
Phase	to decrease setting value	to increase setting value

Note

- You may not obtain an appropriate screen with **Auto adjustment** for some signals. In this case, adjust the settings manually.
- Adjust **Phase** setting after **Clock** setting has been properly adjusted.

EasyLink (HDMI CEC)

This function allows you to operate the linked functions between our brand devices with a EasyLink feature and this unit connecting through an HDMI cable. You must connect this unit to our brand EasyLink devices and be sure its EasyLink setting is also set to On.

1 Use ▲▼ to select **EasyLink**, then press **OK**.

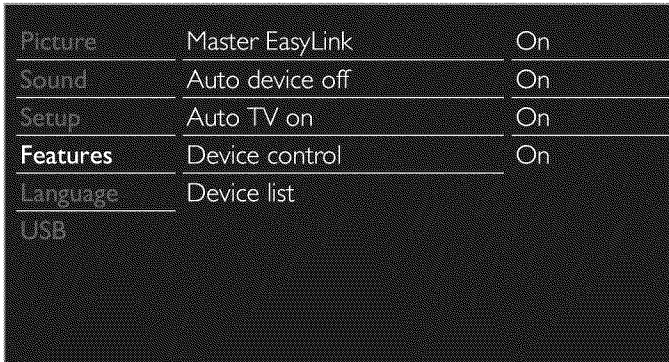

2 Use ▲▼◀▶ to select the item you want to adjust, then press **OK**.

Set the EasyLink control **On** or **Off**. The following additional settings will be grayed out when you set to **Off**.

Master EasyLink	Off	Disables all EasyLink.
	On	Selects if you have connected an external device that is compatible with the EasyLink function.

You can set your device to Turn Off by interlocking from this unit's power:

Auto device off	Off	Your connected EasyLink device stays on even if the unit goes into Standby mode.
	On	Your connected EasyLink device Turns Off automatically when the unit goes into Standby mode.

This unit will Turn On when the Power On signal is sent from your connected EasyLink device.

Auto TV on	Off	This unit stays in Standby mode even if you Turn On your connected EasyLink device.
	On	This unit Turns on automatically when you Turn On your connected EasyLink device.

You can operate some functions such as disc playback or call up the menu of the connected devices, by using this unit's remote control.

Device control	Off	Disables the device control.
	On	PLAY ▶ / STOP ■ / FWD ►► / REV ◀◀ /  OPTIONS / ▲▼◀▶ / OK / BACK / the NUMBER buttons can be used to control your connected EasyLink devices by this unit's remote control.

Device list

This function lets you see the product model number or name of connected devices.

Use ▲▼ to select the desired EasyLink devices listed on the TV screen, then press **OK**.

Your connected EasyLink device will be Turned On if the device is in Stand by mode.

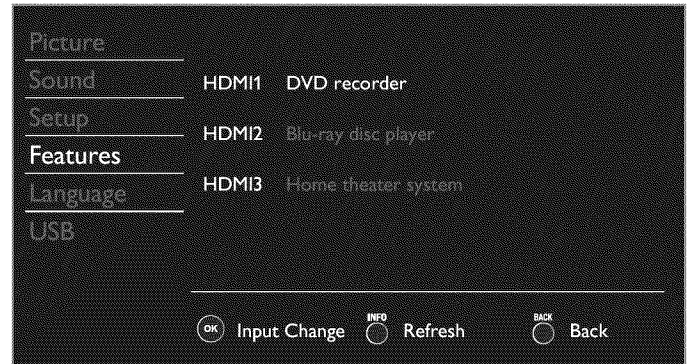

Setting your location to home

You can set the **Location** of your TV to **Home** or **Retail**. Choosing **Home** gives you full flexibility to change predefined settings for picture and sound.

1 Use ▲▼ to select **Location**, then press OK.

Picture	Caption settings	
Sound	Child lock	
Setup	PC settings	
Features	EasyLink	
Language	Location	Home
USB	E-sticker	
	Software upgrade	

2 Use ▲▼ to select **Home** or **Retail**, then press OK.

Retail	The unit will be set up with predefined settings for retail displays. In this setting, the power consumption may possibly exceed the limit requirement of the ENERGY STAR® qualification.
Home	This setting is ENERGY STAR® qualified. The unit is set to maximize the energy efficiency for Home setting and it can be adjusted through a choice of Picture and Sound quality selections according to your preference.

Note

- You must set **Home**. Otherwise, personalized picture and sound settings will not be memorized after the unit goes into Standby mode.

E-sticker

When you set **Location** to **Retail** store, E-sticker (Electronic Sticker) is displayed. E-sticker can be Turned Off using procedure below.

1 Use ▲▼ to select **E-sticker**, then press OK.

2 Use ▲▼ to select **Off**, then press OK.

Off	You can Turn Off E-sticker.
Top	E-sticker is displayed on top of the TV screen.
Bottom	E-sticker is displayed on bottom of the TV screen.

Note

- If you select **Home**, E-sticker will not be displayed.



Language

1 Press  and use ▲▼ to select **Language**, then press OK.

Picture		
Sound	Select your menu language.	English
Setup		
Features	Seleccione el idioma para el menú.	Español
Language		
USB	Sélectionnez la langue du menu.	Français

2 Use ▲▼ to select **English**, **Español** or **Français**, then press OK.

Note

- If you need the English menu instead of the Spanish or French menu's, press . Use ▲▼ to select **Idioma** or **Langue**, then press OK. Use ▲▼ to select **English** then press OK. Press  to exit the main menu.

USB

Your TV is fitted with a USB connection that enables you to view photos or watch Motion JPEG files stored on a USB Memory Stick.

- 1 Connect the USB Memory Stick to the USB terminal on the side of your TV.
- 2 Press **HOME** and use **▲▼** to select **USB**, then press **OK**.
 - The highlighted text will move to the name of your USB Memory Stick, then press **OK** again.

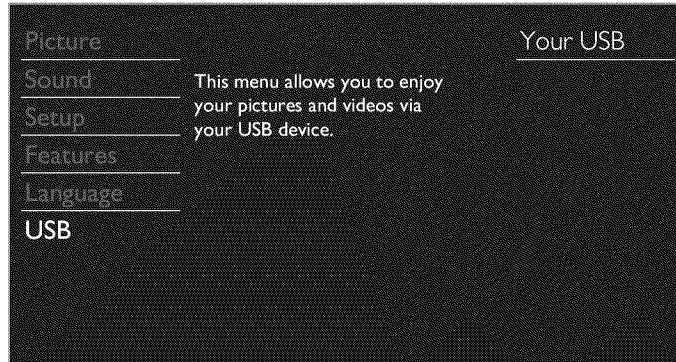

- 3 Use **▲▼** to select the **Picture** or **Video**, then press **OK**.
 - The files recorded under the following specifications are required.

Picture (JPEG)	Upper limit	24Mpixel	
Video (Motion JPEG)	Size	320 × 240 (QVGA)	
	Frame rate	30fps	
	Audio type	LPCM	Sampling frequency (32 kHz, 44.1 kHz or 48 kHz) Quantization bit rate (16 bit)

Note

- Up to 2GB (FAT16) or 8GB (FAT32) capacity can be supported.
- Up to 10,000 files or 1,000 folders with 19 hierarchies can be recognized.
- Up to 255 English characters can be recognized.
- This unit does not support MTP (Media Transfer Protocol).
- This unit supports FAT16 and FAT32 file systems.
- If the file is not supported, an error message appears.
- When the USB Memory Stick is not recognized, try reconnecting it again.
- We cannot be held responsible if your USB Memory Stick is not supported, nor will we accept any liability for damage or loss of stored data.
- To protect your USB Memory Stick files from being erased place the write protect sliding tab in the protect position.
- Be sure to keep a backup copy of the original files on your device before you play them back on this unit.
- This unit does not recognize USB Memory Stick that requires a special driver.
- This unit is not allowed to use the USB Memory Stick which requires an external power supply (500mA or more).
- A file name exceeding 128 characters or contains a dot character is not supported on this TV.
- Progressive JPEG files are not supported.
- Only a Motion JPEG file with an ".avi" extension is supported. An extension ".mov" is not supported.
- During Motion JPEG playback, "Pause", "Forward" and "Reverse" do not work on this unit.

Picture (JPEG)

- 1 Use **▲▼** to select the desired file, then press **OK**.

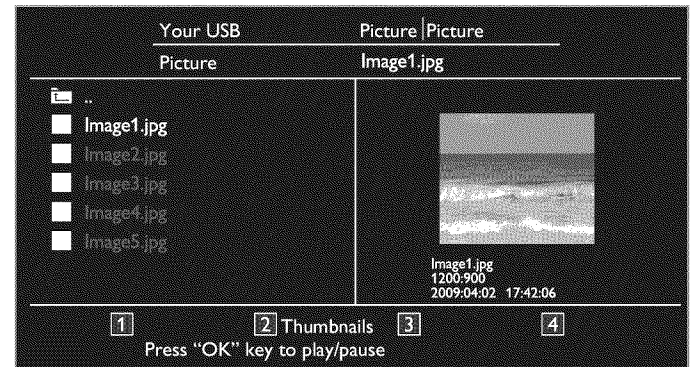

- To toggle between **List** and **Thumbnails** press the **NUMBER 2** button each time.
- The unit goes to the Slide show automatically. To pause / play the Slide show, press **OK**.
- Use the **NUMBER buttons** (1 through 4) to see the file detail (**1**) or change the following settings (**2** ~ **4**). See the description in table below.

Item	Detail
1 More Detail	Press 1 to display file details below. Name, Album, Date, Size and Next . Press 1 again to remove file details.
4 Start show	Press 4 or OK to start the Slide show. While the Slide show is on, the following 2 settings will be displayed.
2 Transitions	Press 2 , then use ▲▼ to select the transition mode choosing from; None, Dissolve, Wipe right, Wipe left, Wipe up, Wipe down, Box in and Box out .
3 Slide time	Press 3 , then use ▲▼ to change the display time choosing from; Short, Medium and Long .
4 Stop show	Press 4 or OK to stop the Slide show. While the Slide show is Off, the following 2 settings will be displayed.
2 Rotate	Every press on 2 will turn the picture clockwise by 90 degrees.
3 Zoom	Press 3 , then use ▲▼ to select the zoom factor (1x, 2x or 4x). Press OK to set the zoom factor.

Video (Motion JPEG)

- 1 Use **▲▼** to select the desired file, then press **OK**.

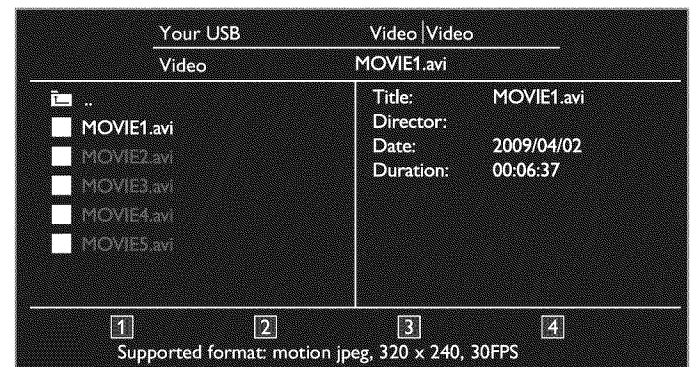

- To stop playback and return to the file list, press **BACK**, **OK** or **CH +**.
- Press **CH -** to play back from the beginning.

Item	Detail
1 More Detail	Press 1 to display file details below. Title, Director, Date and Duration . Press 1 again to remove file details.

6 Upgrade your TV software

Philips continuously tries to improve its products and we strongly recommend that you upgrade the TV software when upgrades are available.

New software can be downloaded from our website at www.philips.com/support using the model number of your TV to find information.

Checking your current software version

- 1 Press **Home** and use **▲▼** to select **Features**, then press **OK**.
- 2 Use **▲▼** to select **Software upgrade**, then press **OK**.

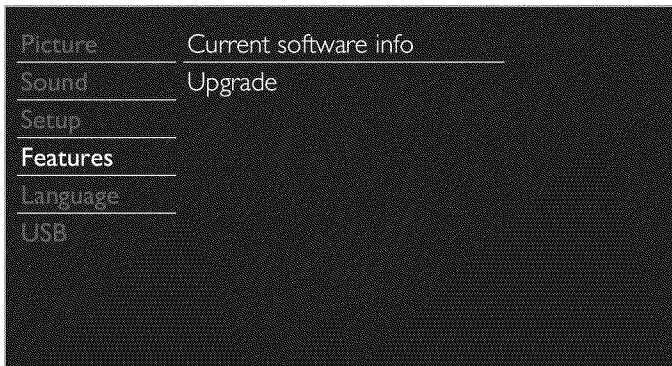

- 3 Use **▲▼** to select **Current software info**, then press **OK**.
 - The version and a description of the current software is displayed.

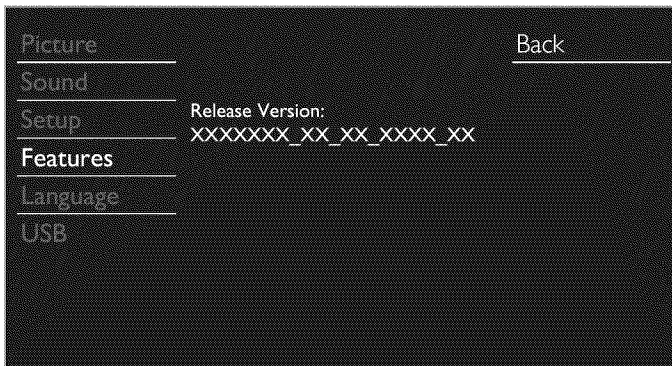

Upgrading the software

You can upgrade the software by using USB Memory Stick.

Preparing for the software upgrade

You require the following equipment :

- A PC with web browsing capability.
- An archive utility that supports the ZIP-format (e.g. WinZip for Windows or Stuffit for Mac OS).
- An empty clean formatted USB Memory Stick.

Note

- Only FAT / DOS-formatted portable memory is supported.
- Use only software upgrades that can be found on the Philips web site.

Downloading the software

Find information and software related to your TV and download the latest software upgrade file to your PC.

- 1 On your PC, open a web browser and go to www.philips.com/support
- 2 Enter the model number in the "Type the Model Number.." field.
- 3 Click the desired software to be downloaded.
 - Decompress the ZIP-file.
- 4 Copy the upgrade file to the root directory of the USB Memory Stick.

Starting the software upgrade

Warning

- When the software upgrade is running, don't press any buttons.
- Do not remove the USB Memory Stick during the software upgrade.
- If an error occurs during the upgrade, retry the procedure or for further assistance, please contact Call Center.

- 1 Connect your USB Memory Stick with the upgrade file to the USB terminal on the side of your TV.

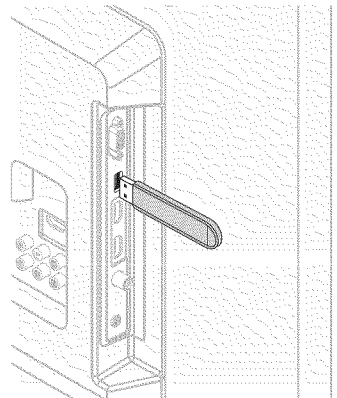

- 2 Press **Home** and use **▲▼** to select **Features**, then press **OK**.
- 3 Use **▲▼** to select **Software upgrade**, then press **OK**.
- 4 Use **▲▼** to select **Upgrade**, then press **OK**.
- 5 Read the on-screen instructions and confirm that you want to continue with the installation.

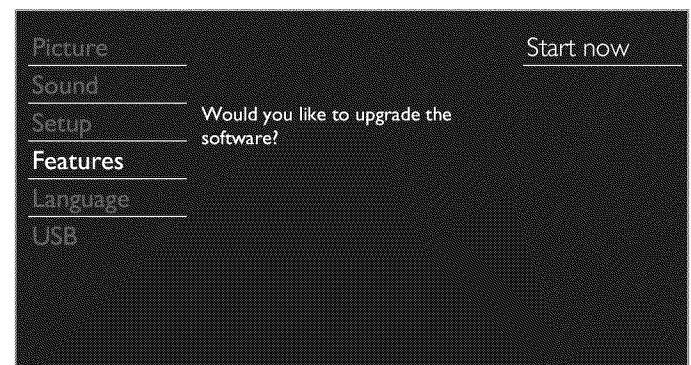

- 6 When the software upgrade is completed, press **Power** to set the unit into Standby mode, then remove the USB Memory Stick and then press **Power** again to Turn the unit On.
 - The TV starts up with the new software.

For further assistance, please contact Call Center.

7 Useful tips

FAQ

Question	Answer
My remote control does not work. What should I do?	<ul style="list-style-type: none"> • Check the antenna or cable connection to the main unit. • Check the batteries of the remote control. • Check if there is an obstacle between the infrared sensor window and the remote control. • Test the signal Output use IR Signal Check. → p.36 If okay, then possible infrared sensor trouble. • Aim the remote control directly at the infrared sensor window on the front of the unit. • Reduce the distance to the unit. • Re-insert the batteries with their polarities (+/-) as indicated. • When there is an infrared-equipped device such as PC near this unit, it may interrupt the remote control signal of this unit. Move the infrared-equipped device away from this unit, change the angle of the infrared sensor or Turn Off the infrared communication function.
How come the Initial setup appears every time I Turn On this unit?	<ul style="list-style-type: none"> • Connect the RF coaxial cable to the unit directly and run the initial setup. • Make sure to complete the initial setup before the unit goes into Standby mode.
Why can I not watch some RF signal TV programs.	<ul style="list-style-type: none"> • Autoprogram must be completed when you set up the unit for the first time or move it to a location where previously unavailable channels are broadcast. • Make sure Autoprogram has been completed. → p.24 • The selected channel may not be broadcasting. • When Autoprogram is interrupted and not completed, some channels will not be received. Make sure to complete the Autoprogram. → p.24 • The selected channel cannot be viewed by the Child and ratings lock setting. → p.27 • The unit requires some kind of antenna Input. An indoor antenna (Digital or VHF / UHF), an external antenna (Digital or VHF / UHF) or an RF coaxial cable from your wall Cable / Satellite set-top box needs to be plugged into the unit.
How come there is no image from the connected external devices?	<ul style="list-style-type: none"> • Check if the correct Input mode is selected by pressing  SOURCE or using CH + / -. Refer to Watching channels from an external device. → p.19 • Check the antenna, cable or other Input connection to the unit. • When using the Component Video connection check that the Green (Y), Blue (Pb/Cb) and Red (Pr/Cr) connectors are connected to their corresponding colored jacks on the unit.
When I enter a channel number, it changes automatically.	<ul style="list-style-type: none"> • Many Digital channels have alternate channel numbers. The unit changes the numbers automatically to the ones signifying the broadcasting station channel number. These basic numbers used for previous Analog broadcasts. (e.g, Input ch# 30 automatically changes to ch# 6.1)
Why are captions not displayed entirely? Or, captions are delayed behind the dialog.	<ul style="list-style-type: none"> • Captions that are delayed a few seconds behind the actual dialog are common for live broadcasts. Most captioning production companies can display a dialog to maximum of 220 words per minute. If a dialog exceeds that rate, selective editing is used to insure that the captions remain up-to date with the current TV screen dialog.
How can I set the clock?	<ul style="list-style-type: none"> • There is no clock function on this unit.
I cannot change the Child lock setting because my PIN code no longer works.	<ul style="list-style-type: none"> • If a Power failure occurs for longer than 10 seconds the child lock setting is retained, but the PIN code is reset to the default code 0000. Refer to Child and ratings lock. → p.27

Troubleshooting

If the unit does not perform properly when operated as instructed in this User Manual, **check the following Troubleshooting tips and all connections once before calling for service.**

Power

No power

- Make sure the AC power cord is plugged in.
- Make sure that the AC outlet supplies the proper voltage, plug another electrical appliance into the AC outlet to ensure that the AC outlet operates normally.
- If a power failure occurs, unplug the AC power cord for 1 minute to allow the unit to reset itself.

Remote

Control buttons do not work.

- Press only one button at a time. Do NOT press more than one button at the same time.
- Ensure that no buttons on the remote control are depressed and move freely.

Universal remote control does not work properly.

- Refer to the user manual of the universal remote control for the Philips code.

Picture

Power is ON but no screen image.

- Check whether the connection of the Antenna or Cable / Satellite set-top box is connected correctly.
- Check whether all the cables to the unit are connected to the correct Output jack of your device like Blu-ray disc / DVD recorder.
- Make sure that the selected Input mode is connected to the working Input jack.
- Check if your computer is NOT in sleep mode when the Input mode of this unit is in PC mode. Tap any key on the keyboard to wake up your computer.

No color

- View other TV channels. The problem might be limited to the broadcasting station or weak signal strength.
- Adjust **Color** in **Picture** settings. → p.23

Picture poor; sound OK

- Electrical interference from nearby appliances may affect picture quality.
- Adjust **Contrast** and **Brightness** in **Picture** settings. → p.23
- View other TV channels. The problem might be limited to the broadcasting station or weak signal strength.
- For the best picture quality, watch High Definition wide screen programs. If the HD content is not available, watch Standard Definition programs instead.

You see noise or trash on the screen.

- When the capabilities of the unit exceed the capabilities of the Digital broadcasting, the signal will be increased to match the capabilities of the display of the unit. This may cause noise or trash.



Unusual picture appears and the TV does not operate.

- Press the power button first. If it does not solve the problem, then press the buttons on the remote control in the order shown below.

SLEEP → FORMAT → ► → ▲ → ▼ → ⏻

Picture & Sound

No picture or sound

- Check if the Power is on.
- Check whether all the cables to the unit are connected to the correct Output jack of your device like Blu-ray / DVD recorder.
- View other TV channels. The problem might be limited to the broadcasting station or weak signal strength.
- Unplug the AC power cord and wait for about 1 minute, then plug the AC power cord and Turn On the unit again.
- Check whether the connection of the Antenna or Cable / Satellite set-top box is connected correctly.
- Make sure that the selected Input mode is connected to the working Input jack.
- Check if your computer is NOT in sleep mode when the Input mode of this unit is in PC mode. Tap any key on the keyboard to wake up your computer.
- Make sure that the sound is not muted. Press  so that the volume bar and current volume level will appear on the TV screen.
- Make sure that the volume is NOT set to 0 or . If so, use VOL + / - to adjust to the desired volume.

Adjusted Picture or Sound settings are not effective every time the unit is Turned On.

- You must set **Home in Location**. → p.31 Otherwise, the settings you adjusted will not be memorized after the unit goes into Standby mode.

You see a distorted picture or hear an unusual sound.

- You may be getting interference from electrical appliances, automobiles, motorcycles or fluorescent lights.
- Try moving the unit to another location to see if this is the cause of the problem.

Ghosts, lines or streaks in picture. (Analog TV- NTSC signal)

- Electrical interference from nearby appliances may affect picture quality.
- View other TV channels. The problem might be limited to the broadcasting station or weak signal strength.

Sound

No sound, distorted sound or incorrect Audio Sound is heard when using the HDMI-DVI connections.

- Make sure that the Analog Audio signals from the HDMI-DVI device are connected to the Analog Audio (L/R) Input jacks.
- When using Component Analog Video, Composite Analog Video or PC VGA Video make sure that the Analog Audio (L/R) connectors are mounted into the Audio (L/R) Input jacks.

Sound poor; Picture OK

- View other TV channels. The problem might be limited to the broadcasting station or weak signal strength.
- Check if the audio cable is connected into the unit correctly.

You switch to a different Input and the volume changes.

- This unit will memorize the volume level from the last time you adjusted it.
- If the volume of the sound from another device is higher or lower, then the loudness will change.
- Make sure **Auto volume leveling** is set to **On**. → p.24

Screen

You switch to a different Input and the screen size changes.

- This unit will memorize the viewing mode from the last time you used the particular Input modes.

The display image does not cover the entire screen.

- If you are using the unit as a PC monitor; make sure that **Horizontal position** and **Vertical position** in **PC settings** are set correctly.
- If you are watching TV or using the Composite Video, Component Video or HDMI with 480i Input, press **FORMAT** repeatedly to switch various screen modes.

Different color marks on the TV screen

- View other TV channels. The problem might be limited to the broadcasting station, missing data or pixelation.

Captions

Captions are displayed as a white box. No caption is displayed in the Closed Caption-supported program.

- Interference from buildings or weather conditions may cause captioning to be incomplete if watching Analog TV signals.
- Broadcasting station may shorten the program to insert advertisements.
- The Closed Caption decoder cannot read the information of the shortened program.

Black box is displayed on the TV screen.

- The text mode is Selected. For caption, select **CC-1**, **CC-2**, **CC-3** or **CC-4**.

Note

- The LCD screen is manufactured to provide many years of useful life. Occasionally a few non active pixels may appear as a fixed point of blue, green or red. This is not to be considered a defect in the LCD screen.
- Some functions are not available in specific modes, but this is not a malfunction. Read the description in this User Manual for more details on correct operations.

8 Information

Glossary

Analog TV (NTSC)

Acronym that stands for National Television Systems Committee and the name of Analog broadcasting standards. Off the air Analog TV signals are no longer being sent by major broadcasting stations in the USA.

Aspect ratio

The width of a TV screen relative to its height. Conventional TVs are 4:3 (in other words, the TV screen is almost square); widescreen models are 16:9 (the TV screen is almost twice as wide as its height).

CEC (Consumer Electronics Control)

This allows you to operate the linked functions between our brand devices with CEC feature and this unit. We do not guarantee 100% interoperability with other brands of CEC compliant devices.

Component Video

This is a video signal format that conveys each of 3 principal colors of light (red, blue and green) through different signal lines. This allows the viewers to experience picture colors as original as it is. There are several signal formats, including Y / Pb / Pr and Y / Cb / Cr.

Dolby Digital

The system developed by Dolby Laboratories to compress Digital sound. It offers stereo sound (2ch) or multi-channel audio.

DTV (ATSC)

Initialism that stands for Advanced Television Systems Committee and the name of the Digital broadcasting standards.

E-sticker

E-sticker is showing set features, technical information, etc on this TV set that is displayed on the TV screen mainly used by TV retailers. Previously the information was on a printed sticker that was put on the display.

HDMI (High-Definition Multimedia Interface)

Interface that supports all uncompressed, Digital Audio / Video formats including set-top box, Blu-ray / DVD recorder or Digital television, over a single cable.

HDTV (High Definition TV)

Ultimate Digital format that produces high resolution and high picture quality.

PIN code

A stored 4-digit number that allows access to parental control features.

SAP (Secondary Audio Program)

Second-audio channel delivered separately from main-audio channel. This audio channel is used as an alternate in bilingual broadcasting.

SDTV (Standard Definition TV)

Standard Digital format that is similar to the Analog TV picture quality.

SRS TruSurround XT[®]

Creates a truly immersive surround sound experience with rich bass and clear dialog from only two speakers.

Maintenance

Cabinet Cleaning

- Wipe the front panel and other exterior surfaces of the unit with a soft cloth.
- Never use a solvent or alcohol. Do not spray insecticide liquid near the unit. Such chemicals may cause damage and discoloration to the exposed surfaces.

Panel Cleaning

Wipe the panel of the unit with a soft cloth. Before cleaning the panel, disconnect the AC power cord.

Servicing

Should your unit become inoperative, do not try to correct the problem yourself. There are no user serviceable parts inside. Call our toll free customer support line found on the cover of this User Manual to locate an authorized service center.

IR Signal Check

If the Remote Control is not working properly, you can use a Digital or Cell Phone Camera to see to see if it is sending out an infrared signal.



e.g.) With a Digital camera:

Point the Digital Camera towards the Remote Control infrared diode at the front of the Remote Control. Press any key on the Remote Control and look at the Camera Display. If an infrared pulsating light appears on the Display, the Remote Control is sending out an IR signal.

Note: Some Cameras have an IR Filter and will not Display the IR signal.

9 Specifications

Model #	50PFL3708	46PFL3708	40PFL4708	40PFL1708	39PFL2708	32PFL3508	32PFL4508	29PFL4508	24PFL4508
Picture									
Type	FHD (1920 × 1080 pixels 60Hz)					WXGA (1366 × 768 pixels 60Hz)			
Diagonal screen size / Aspect ratio	49.5"/ 16:9	46.0"/ 16:9	40.0"/ 16:9		38.6"/ 16:9	31.5"/ 16:9		28.5"/ 16:9	23.6"/ 16:9
Viewing angles	176° (V) by 176° (H)	178° (V) by 178° (H)	176° (V) by 176° (H)	178° (V) by 178° (H)	176° (V) by 176° (H)	178° (V) by 178° (H)		176° (V) by 176° (H)	
Built-in Digital / Analog tuner	ATSC (Digital) / NTSC (Analog)								
Sound									
Mono / Stereo	Mono, Stereo, SRS TruSurround XT [®] (for 40PFL4708, 39PFL2708, 32PFL4508, 32PFL3508, 29PFL4508, 24PFL4508) Mono, Stereo, Incredible Surround (for 50PFL3708, 46PFL3708, 40PFL1708)								
Power Output (RMS watts)	10 W × 2			8 W × 2				5W × 2	
Equalizer	5 band								
Ease of use									
Picture format	SD (4:3 Source) :		Normal / 16:9 / Movie expand / Zoom / Wide						
	HD (16:9 Source) :		Normal / 4:3 / Movie expand / Zoom / Wide						
	HDMI AV (4:3 Source) :		Normal / 16:9 / Movie expand / Zoom / Wide / Full						
	HDMI AV (16:9 Source) :		Normal / 4:3 / Movie expand / Zoom / Wide / Full						
	PC Source :		Normal / Full / Unscaled (Refer to HDMI AV (16:9 Source) above if PC has HDMI Output.)						
Photo Slide show	JPEG files only								
Video playback	Only Motion JPEG 320 × 240, 30fps with file extension "avi" will playback								
Channel									
Channel coverage	Terrestrial DTV (ATSC) :		VHF: 2~13 UHF: 14~69 (each channel has e.g. 2.1~2.9, 3.1~3.9, etc)						
	Terrestrial Analog (NTSC) :		VHF: 2~13 UHF: 14~69						
CATV (Analog NTSC)	2~13, A~W W+1~W+94 (analog W+1~W+84), A-5~A-1, 5A								
Tuning system	Channel frequency synthesized tuning system								
Channel access	Direct access number keyboard, Programmable scan, and Channel up / down								
Connectivity									
Component Video Input (Y/Pb/Pr)	1 supporting video signals : 480i/p, 720p, 1080i 60Hz								
Composite Video Input (shared Y green terminal with Component Video)	1								
HDMI Input	3								
	supporting video signals : 480i/p, 720p, 1080i @60Hz, 1080p @24/30/60Hz PC-Input signal up to FHD (1920 × 1080)					supporting video signals : 480i/p, 720p, 1080i @60Hz, 1080p @24/30/60Hz PC-Input signal up to WXGA (1360 × 768)			
Audio L/R Input	1								
PC Input	via VGA, HDMI and HDMI-DVI + Analog Audio L/R								
USB	1								
Digital Audio Output	1 supporting Dolby Digital								
Headphone Output	1 1/8 inch (3.5mm)								
Power									
Power requirements	120V~ AC +/- 10%, 60Hz +/- 0.5%								
Temperature									
Operating temperature	41 °F (5 °C) to 104 °F (40 °C)								

- Specifications are subject to change without prior notice.

10 Warranty

PHILIPS LIMITED WARRANTY ONE (1) YEAR

WARRANTY COVERAGE:

PHILIPS warranty obligation is limited to the terms set forth below.

WHO IS COVERED:

Philips warrants the product to the original purchaser or the person receiving the product as a gift against defects in materials and workmanship as based on the date of original purchase ("Warranty Period") from an Authorized Dealer. The original sales receipt showing the product name and the purchase date from an authorized retailer is considered such proof.

WHAT IS COVERED:

The Philips warranty covers new products if a defect in material or workmanship occurs and a valid claim is received by Philips within the Warranty Period. At its option, Philips will either (1) repair the product at no charge, using new or refurbished replacement parts, or (2) exchange the product with a product that is new or which has been manufactured from new, or serviceable used parts and is at least functionally equivalent or most comparable to the original product in Philips current inventory, or (3) refund the original purchase price of the product. Philips warrants replacement products or parts provided under this warranty against defects in materials and workmanship from the date of the replacement or repair for ninety (90) days or for the remaining portion of the original product's warranty, whichever provides longer coverage for you. When a product or part is exchanged, any replacement item becomes your property and the replaced item becomes Philips' property. When a refund is given, your product becomes Philips' property.

Note: Any product sold and identified as refurbished or renewed carries a ninety (90) day limited warranty.

Replacement product can only be sent if all warranty requirements are met. Failure to follow all requirements can result in delay.

WHAT IS NOT COVERED - EXCLUSIONS AND LIMITATIONS:

This Limited Warranty applies only to the new products manufactured by or for Philips that can be identified by the trademark, trade name, or logo affixed to it. This Limited Warranty does not apply to any non-Philips hardware product or any software, even if packaged or sold with the product. Non-Philips manufacturers, suppliers, or publishers may provide a separate warranty for their own products packaged with the bundled product.

Philips is not liable for any damage to or loss of any programs, data, or other information stored on any media contained within the product, or any non-Philips product or part not covered by this warranty. Recovery or reinstallation of programs, data or other information is not covered under this Limited Warranty.

This warranty does not apply (a) to damage caused by accident, abuse, misuse, neglect, misapplication, or non-Philips product, (b) to damage caused by service performed by anyone other than Philips or Philips Authorized Service Location, (c) to a product or a part that has been modified without the written permission of

Philips, or (d) if any Philips serial number has been removed or defaced, or (e) product, accessories or consumables sold "AS IS" without warranty of any kind by including refurbished Philips product sold "AS IS" by some retailers.

This Limited Warranty does not cover:

- Shipping charges to return defective product to Philips.
- Labor charges for installation or setup of the product, adjustment of customer controls on the product, and installation or repair of antenna/signal source systems outside of the product.
- Product repair and/or part replacement because of improper installation or maintenance, connections to improper voltage supply, power line surge, lightning damage, retained images or screen markings resulting from viewing fixed stationary content for extended periods, product cosmetic appearance items due to normal wear and tear, unauthorized repair or other cause not within the control of Philips.
- Damage or claims for products not being available for use, or for lost data or lost software.
- Damage from mishandled shipments or transit accidents when returning product to Philips.
- A product that requires modification or adaptation to enable it to operate in any country other than the country for which it was designed, manufactured, approved and/or authorized, or repair of products damaged by these modifications.
- A product used for commercial or institutional purposes (including but not limited to rental purposes).
- Product lost in shipment and no signature verification receipt can be provided.
- Failure to operate per Owner's Manual.

TO OBTAIN ASSISTANCE IN THE U.S.A., CANADA, PUERTO RICO, OR U.S. VIRGIN ISLANDS...

Contact Philips Customer Care Center at:
1-866-309-5962

REPAIR OR REPLACEMENT AS PROVIDED UNDER THIS WARRANTY IS THE EXCLUSIVE REMEDY FOR THE CONSUMER. PHILIPS SHALL NOT BE LIABLE FOR ANY INCIDENTAL OR CONSEQUENTIAL DAMAGES FOR BREACH OF ANY EXPRESS OR IMPLIED WARRANTY ON THIS PRODUCT. EXCEPT TO THE EXTENT PROHIBITED BY APPLICABLE LAW, ANY IMPLIED WARRANTY OF MERCHANTABILITY OR FITNESS FOR A PARTICULAR PURPOSE ON THIS PRODUCT IS LIMITED IN DURATION TO THE DURATION OF THIS WARRANTY.

Some states do not allow the exclusions or limitation of incidental or consequential damages, or allow limitations on how long an implied warranty lasts, so the above limitations or exclusions may not apply to you.

This warranty gives you specific legal rights. You may have other rights which vary from state/province to state/province.

P&F USA, Inc. PO Box 2248, Alpharetta, GA 30023-2248

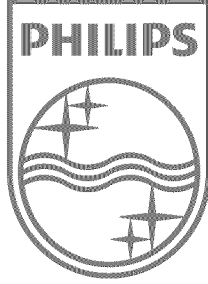

P&F USA, Inc.
PO Box 2248, Alpharetta, GA 30023-2248

P&F Mexicana, S.A. de C.V.
Av. La Palma No. 6, Col. San Fernando La Herradura.
Huixquilucan, Edo. de México. C.P. 52787