

COMMERCIAL ELECTRIC WATER HEATERS



Technical Support and Parts: 800-456-9805
www.americanwaterheater.com

**MODELS STCE3-52/80/119
& ITCE3-52/80/119**

**INSTALLATION CONSIDERATIONS - PRE SERVICE
CHECKS - WATER HEATER CONSTRUCTION -
OPERATION & SERVICE - TROUBLESHOOTING**



SERVICING SHOULD ONLY BE PERFORMED BY A QUALIFIED SERVICE AGENT.

COMMERCIAL ELECTRIC WATER HEATER

SERVICE MANUAL

TABLE OF CONTENTS

INTRODUCTION	2	ELECTRONIC CONTROLS.....	41
Qualifications	2	CCB - Central Control Board	42
Service Warning	2	CCB Socket & Wiring Terminal Identification	43
Tools Required.....	3	CCB Enable Disable Circuit(s) Test.....	45
INSTALLATION CONSIDERATIONS	4	Checking Power And Ground To The CCB	46
Closed Water Systems	4	UIM - User Interface Module	47
Thermal Expansion.....	4	ELECTRONIC CONTROL SYSTEM	48
Electrical Requirements.....	5	Control System Features.....	48
PRE SERVICE CHECKS.....	6	Control System Navigation	48
Wiring Connections	6	The Desktop Screen.....	49
Service Precautions.....	5	Status Icons.....	50
WATER HEATER CONSTRUCTION	7	Operating States.....	51
Surface Mount Control Models	8	Control System Menus.....	51
Electronic Control Models.....	9	Temperatures Menu.....	52
OPERATION & SERVICE.....	10	Temperature Settings.....	53
Principles of Electricity.....	10	Heater Status Menu.....	54
Single And Three Phase Power	12	Economy Mode Setup Menu	55
Checking Single Phase Power	13	Setpoint Adjustment Value	56
Checking Three Phase Power.....	14	Time Clock Settings	57
Phase Conversions - Surface Mount Control Models.....	15	Daily Operating Mode Settings.....	58
Phase Conversions - Electronic Control Models	16	Alarm Output Setup Menu	59
Fuses.....	17	Display Settings Menu.....	60
Surface Mount Thermostats	18	Heater Information Menu.....	61
Thermostat & ECO Test.....	19	Current Fault/Alert Menu	62
Heating Elements	20	Fault History Menu	62
Heating Element Construction.....	20	Fault Occurrence Menu	62
Heating Element Amperage Test.....	23	Restore Factory Defaults Menu.....	63
Heating Element Voltage Test	24	Factory Default User Settings	63
Heating Element Resistance & Ground Test.....	25	TROUBLESHOOTING.....	64
Replacing Heating Elements	26	Common Service Problems.....	64
Element Sensors	27	Surface Mount Control Models.....	64
Element Sensor Operation	28	Electronic Control Models.....	65
Contactors	29	Fault Conditions	65
Contactor Configurations.....	30	Alert Conditions	65
Contactor Inspection.....	31	Resetting The Control System	65
Contactor Coil Voltage - At Contactor.....	32	Control System Unresponsive	65
Contactor Coil Voltage - At CCB.....	33	UIM Display Is Blank	65
Transformers	34	UIM Is Inoperable	66
120 VAC Control Circuit Transformer Wiring.....	34	Heating Cycle Disabled	66
120 VAC Control Circuit Transformer Test.....	35	Fault & Alert Messages	67
24 VAC Transformer Test	36	No Current Detected	67
Immersion Temperature Probes	37	Temp Probe Open	68
Temperature Sensor Resistance Test.....	38	Temp Probe Short	68
Temperature Sensor DC Voltage Test.....	39	Energy Cut Out (ECO)	69
ECO Continuity Test.....	39		
ECO Voltage Test.....	40		

INTRODUCTION

This Service Manual is designed to be an aid in servicing and troubleshooting the commercial electric water heater models listed on the cover. The instructions, illustrations and procedures contained in this manual are used to verify proper operation and to diagnose and repair common service problems.

This Service Manual does not replace or supersede the Instruction Manual that came with the water heater. Always refer to the Instruction Manual that came with the water heater for complete installation instructions. If the Instruction Manual is not available copies can be obtained from the manufacturers web site or by calling the toll free phone number shown on the back cover of this Service Manual.

Review the Common Service Problems on page 64 prior to performing any service procedures.

QUALIFICATIONS - QUALIFIED SERVICE AGENT

Servicing the products referenced in this manual requires ability equivalent to that of a Qualified Agency (as defined by ANSI below) in the field involved. Installation skills such as plumbing, electrical supply are required in addition to diagnostic and electrical testing skills when performing service.

ANSI Z223.1 2006 Sec. 3.3.83: “Qualified Agency” - “Any individual, firm, corporation or company that either in person or through a representative is engaged in and is responsible for (a) the installation, testing or replacement of gas piping or (b) the connection, installation, testing, repair or servicing of appliances and equipment; that is experienced in such work; that is familiar with all precautions required; and that has complied with all the requirements of the authority having jurisdiction.”

SERVICE WARNING

If you are not qualified (as defined by ANSI above) and licensed or certified as required by the authority having jurisdiction to perform a given task do not attempt to perform any of the service, diagnostic or troubleshooting procedures described in this manual. If you do not understand the instructions given in this manual or do not feel confident in your abilities to perform a given task do not attempt to perform any procedures outlined in this manual. Call the toll free phone number listed on the back cover of this manual for technical assistance.

IMPORTANT SERVICE REMINDER

When performing any troubleshooting step outlined in this manual always consider the wiring and connectors between components. Perform a close visual inspection of all wiring and connectors to and from a given component before replacement. Ensure wires were stripped before being crimped in a wire connector. Ensure wires are crimped tightly in their connectors. Ensure connection pins in sockets and plugs are not damaged or worn. Also ensure plugs and sockets are mating properly and providing good contact.

Failure to perform this critical step or failing to perform this step thoroughly often results in needless down time, unnecessary parts replacement, and customer dissatisfaction.

INSTRUCTION MANUAL

Have a copy of the Instruction Manual that came with the water heater on hand for the correct model water heater you are working with before servicing.

Installation information given in this Service Manual **IS NOT** a complete installation instruction. Installation information covered in this Service Manual has a limited focus as it applies to servicing. This Service Manual does not replace or supersede the Instruction Manual that came with the water heater. Always refer to the Instruction Manual that came with the water heater for complete installation instructions.

If the Instruction Manual is not on hand copies can be obtained from the manufacturers web site or by calling the toll free phone number shown on the back cover of this Service Manual.

TOOLS REQUIRED

- Instruction Manual that came with the water heater.
- All tools common to installation and service of commercial water heaters such as hand tools, torch, pipe wrenches etc.
- Electrical switch lock out device - used to secure disconnect switches/breaker panels while servicing.
- Insulated fuse puller(s).
- Adhesive numbered/colored wire markers - 3M ScotchCode SDR0-9 Numbered Wire Markers; 3M ScotchCode STD-C Colored Wire Markers or equivalent.
- Volt-Ohm Multi Meter - recommend Fieldpiece HS36, Fluke 187, UEI model DL289 or equivalent capable of measuring:
 - AC Voltage up to 600 VAC
 - DC Voltage up to 24 VDC
 - Ohms up to 2,000,000 ohms
- AC amp meter - recommend UEI model DL289 or equivalent capable of measuring:
 - AC amperage up to 400 amps

INSTALLATION CONSIDERATIONS

Installation information given in this Service Manual **IS NOT** a complete installation instruction. Installation information covered in this Service Manual has a limited focus as it applies to servicing. This Service Manual does not replace or supersede the Instruction Manual that came with the water heater. Always refer to the Instruction Manual that came with the water heater for complete installation instructions.

If the instruction Manual that came with the water heater is not on hand copies can be obtained from the manufacturers web site or by calling the toll free phone number shown on the back cover of this Service Manual.

CLOSED WATER SYSTEMS

Water supply systems may, because of code requirements or such conditions as high line pressure, among others, have installed devices such as pressure reducing valves, check valves, and back flow preventers. Devices such as these cause the water system to be a closed system.

Virtually all commercial and most residential water supply systems are closed systems today. Closed water systems will experience thermal expansion which, if not controlled with a properly installed and sized thermal expansion tank, can cause premature failure (leakage) of the water heater. Water heater failure (leakage) on closed systems where there is not a thermal expansion tank installed is not covered under the limited warranty.

THERMAL EXPANSION

As water is heated, it expands (thermal expansion). In a closed system the volume of water will grow when it is heated. As the volume of water grows there will be a corresponding increase in water pressure due to thermal expansion. Thermal expansion can cause premature tank failure (leakage). **This type of failure is not covered under the limited warranty.** Thermal expansion can also cause intermittent temperature-pressure relief valve operation: water discharged from the valve due to excessive pressure build up. **This condition is not covered under the limited warranty.** The temperature-pressure relief valve is not intended for the constant relief of thermal expansion.

A properly sized thermal expansion tank should be installed on all closed systems to control the harmful effects of thermal expansion.

ELECTRICAL REQUIREMENTS

Grounding

Review the electrical ground requirements given in the Instruction Manual that came with the water heater and ensure the water heater has been properly grounded.

The water heater must be grounded in accordance with the National Electric Code and/or local codes. These codes must be followed in all cases.

The water heater must be connected to a grounded metal, permanent wiring system; or an equipment grounding conductor must be run with the circuit conductors and connected to the equipment grounding terminal or lead on the water heater.

Service Note: Electronic Control Models (see Figure 2 on page 9) covered in this manual may experience erratic control operation if the water heater is not properly grounded.

Power Supply

Review the electrical requirements listed on the water heater's rating label and in the Instruction Manual that came with the water heater. Ensure the branch circuit supplying power to the water heater is within these requirements and properly connected.

Ensure the power supply phase (single or three phase / 1Ø, 3Ø) and power supply voltage match the water heater's rating label - see pages 12-14. The electric water heater models covered by this manual are phase convertible - see pages 15 and 16.

PRE SERVICE CHECKS

WIRING CONNECTIONS

With the power supply to the water heater turned off ensure the wiring connections are properly tightened to all components including: high voltage terminal blocks, fuse blocks, contactors, transformers and heating elements.

Loose connections at any connection point will cause increased amperage and excessive heat which can damage wiring and components. Whenever worn or damaged wiring and components must be replaced ensure all wiring connections are properly tightened before putting the water heater back in service.

SERVICE PRECAUTIONS

- 1 **DO NOT** energize the branch circuit supplying power to the water heater or test the water heater electrical system before the water heater is completely filled with water. Read the start up procedures in the Instruction Manual that came with the water heater.
- 2 Be sure to turn off power and use a lock out device at the branch circuit power supply disconnect switch or breaker when servicing the electrical system of the water heater. Never touch electrical components with wet hands or when standing in water.
- 3 When replacing heating elements ensure they are rated at the correct voltage and KW for the water heater being serviced - see Heating Element Ratings and Heating Element Configurations on page 21 and Replacing Heating Elements on page 26.
- 4 When replacing fuses use an insulated fuse puller to remove and install fuses. Always use the correct size for the circuit. See the Replacement Fuses Service Note on page 17 in this manual.
- 5 Using an AC volt meter measure the branch circuit power supply voltage to the water heater. Ensure the measured voltage of the branch circuit supplying power to the water heater matches the water heater's rating label - see pages 12 - 14.
- 6 Ensure the internal power phase configuration matches the power supply to the water heater. The water heaters covered by this manual are phase convertible - see pages 15 and 16.
- 7 Electronic Control Models covered by this manual are equipped with contactors and will have a multi tap control circuit transformer. This is a step down transformer that outputs 120 VAC (secondary winding) which is used to power the electronic control system and energize the contactor coils. The transformer can accommodate different power supply voltages and has multiple input voltage connections or "taps." Ensure the input supply voltage (primary winding) wiring to the transformer is connected properly. See page 34 in this manual.

Service Note - Contactor Chatter: Incorrect supply voltage wiring to the multiple tap 120 VAC Control Circuit Transformer on Electronic Control Models will cause low/high output voltage from the transformer. This can cause contactors to open and close their contacts rapidly (contactor chatter) and result in permanent damage to the contactors. Ensure the primary winding of the multiple tap 120 VAC Control Circuit Transformer is wired to match the power supply voltage - see pages 12 -14 and page 34.

WATER HEATER CONSTRUCTION

There are two types of commercial electric water heaters covered in this manual. See Figure 1 on page 8 and Figure 2 on page 9.

SURFACE MOUNT CONTROL MODELS

The first type of water heater covered in this manual is equipped with surface mount thermostat/ECO controls - **Surface Mount Control Models**. There will be separate thermostat/ECO (energy cut out) combination controls mounted to the surface of the storage tank directly above the heating elements they control. IE: a water heater equipped with 9 heating elements will have 9 combination thermostat/ECO controls. These combination thermostat/ECO controls sense temperature directly from the surface of the storage tank. Each combination control will have a temperature setting adjustment screw. As the tank (water) temperature rises and falls each individual thermostat will de-energize and energize one heating element according to it's temperature setting.

ELECTRONIC CONTROL MODELS

The second type of water heater covered in this manual is equipped with an electronic control system - **Electronic Control Models**. The control system senses temperature electrically from an **Immersion Temperature Probe**. The probe is installed in a threaded opening in the storage tank (wet well) and senses water temperature directly. As the stored water temperature rises and falls the control system de-energizes and energizes Banks of 3 heating elements indirectly using electromagnetic contactors. The control system energizes the electromagnetic contactor's (120 VAC) coil causing the switch contacts of the contactor to close which in turn supplies power to the heating elements.

HEATING ELEMENT CONFIGURATIONS

Both types of water heaters covered in this manual are factory equipped with either 3, 6 or 9 heating elements depending on how they were ordered from the factory - see the Heating Element Configurations table on page 21. Each group of 3 heating elements (physically installed in diagonal rows of 3) is referred to as a "Bank" of heating elements. Bank 1 is the lowest group of 3 heating elements, Bank 2 is the middle group of 3 heating elements and Bank 3 is the upper group of 3 heating elements. See Figure 1 on page 8 and Figure 2 on page 9.

Heating Element Voltage and KW Conversion Kits

Voltage and heating element KW conversion kits are available for the water heaters covered in this manual. Voltage and KW conversions are not covered in this manual. Voltage and KW conversion kits with instructions are available from local distributors and can be ordered from the manufacturer's parts department by calling the toll free number listed on the back cover of this manual. Have the complete model and serial number along with the listed voltage and input KW from the rating label of the water heater on hand before calling.

Service Note: There are field conversion kits to increase/decrease KW input and change voltage. However, conversion kits do not allow adding heating elements to a water heater. Water heaters must remain as they were configured with 3, 6 or 9 heating elements from the factory. **HEATING ELEMENTS CANNOT BE ADDED TO A WATER HEATER.**

SURFACE MOUNT CONTROL MODELS

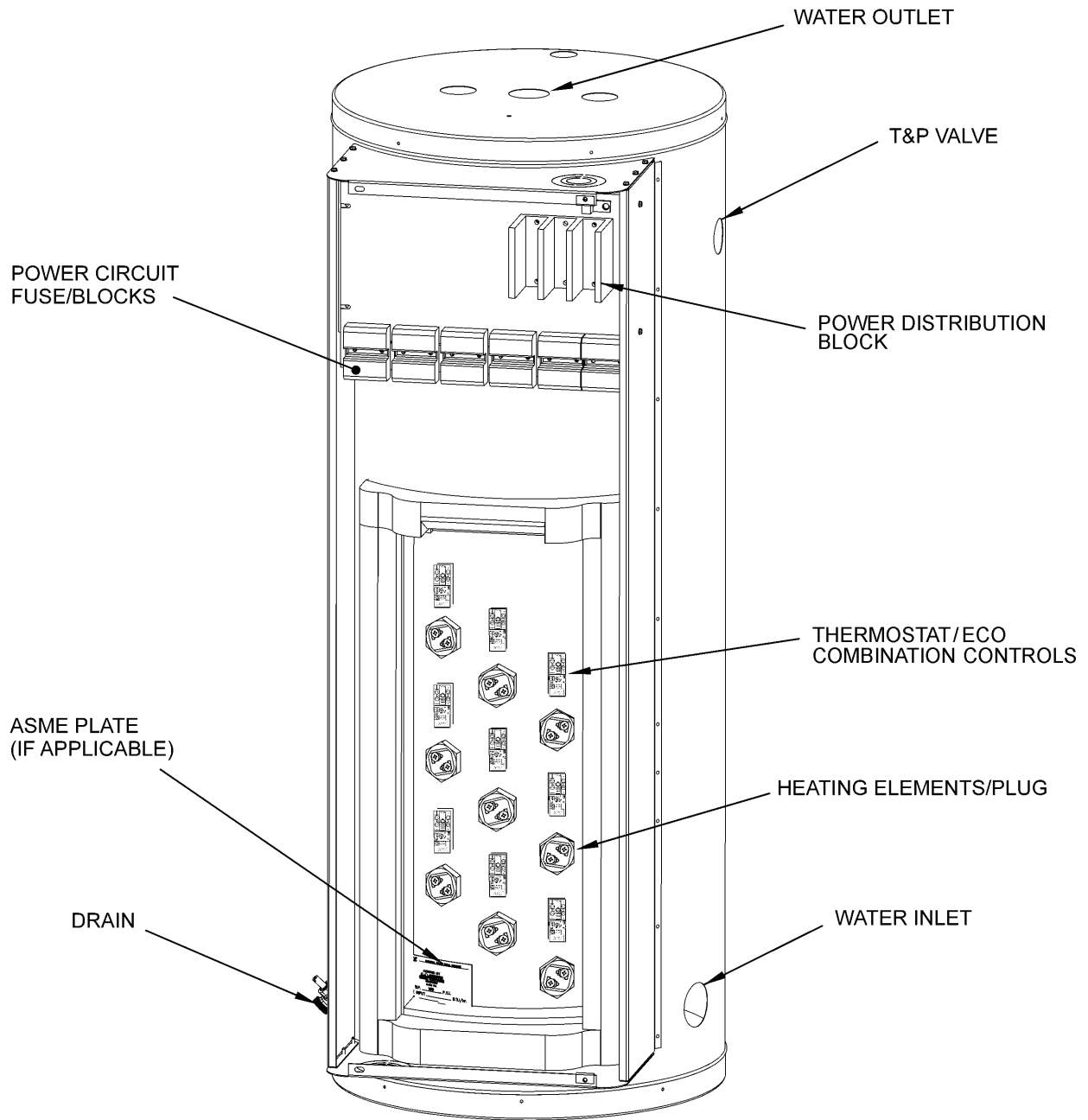

Figure 1



ELECTRONIC CONTROL MODELS

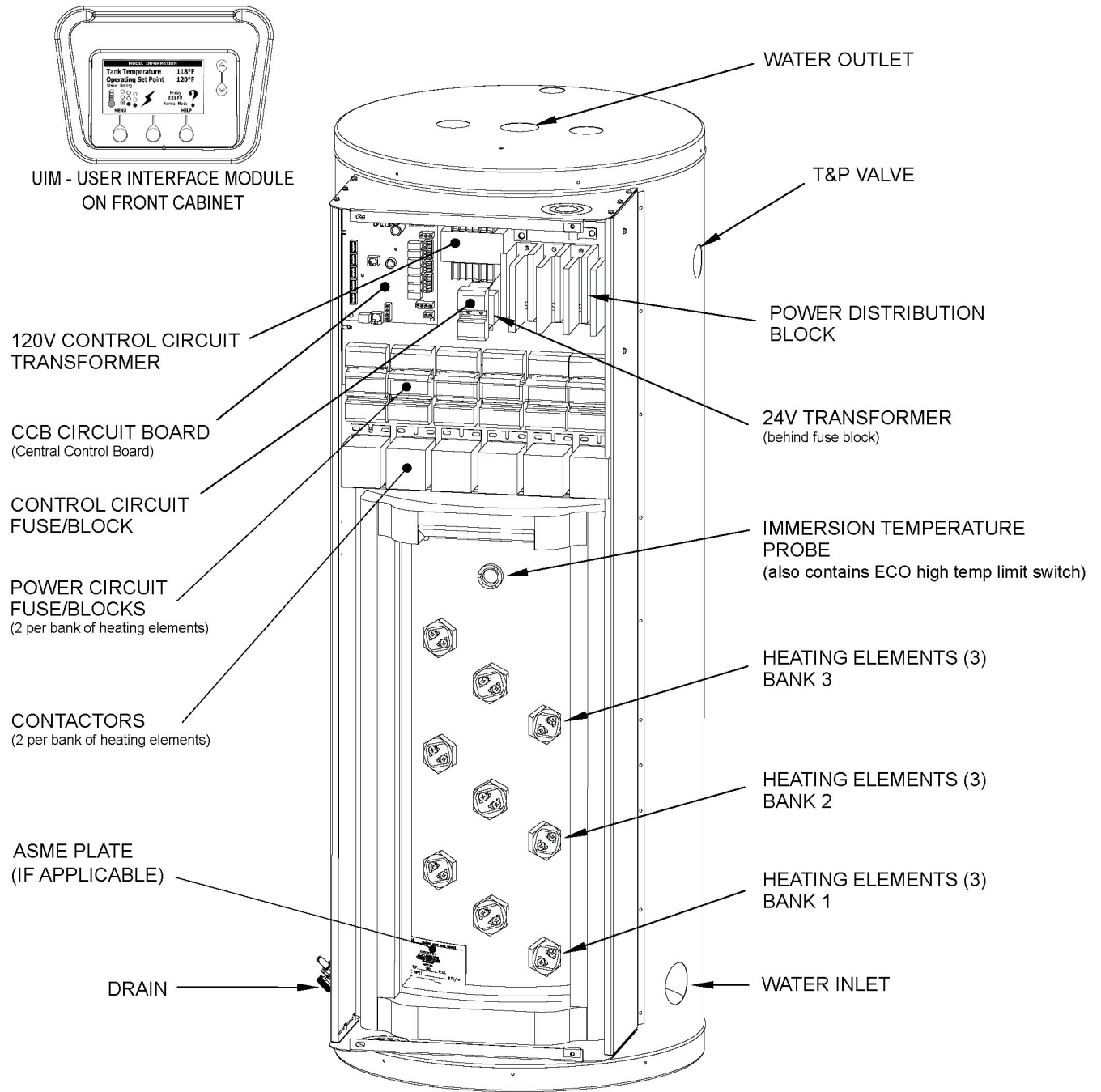

Figure 2



OPERATION & SERVICE

This section of the manual will cover the principles of electricity, single and three phase power, fuses, surface mount thermostat/ECO combination controls, heating element construction & operation, heating element sensors, contactors, common service procedures and more. Information and service procedures presented in this section will be referenced in the troubleshooting sections.

PRINCIPLES OF ELECTRICITY

Voltage

The unit of measurement used to quantify electrical pressure or the force that causes electrical energy to flow is the volt or voltage. Volt meters are used to determine if there is an adequate supply of electricity or voltage to a heating element.

Amperage

The unit of measurement used to quantify the rate at which electrical current is flowing is the ampere or amp. Amp meters are used to determine if a heating element is working - if there is adequate current flowing through the heating element.

Ohms

The unit of measurement used to quantify the opposition or “resistance” to the flow of electricity is the ohm. As resistance (*ohms*) in an electrical circuit increases current (*amperage*) will decrease and as resistance decreases current will increase. Ohm meters are used for measuring the resistance of heating elements, for open circuit continuity tests on heating elements and for shorted to ground continuity tests on heating elements.

Service Note: Volt, ohm and amp meter test instruments are necessary to perform the service and diagnostic procedures outlined in this manual - see Tools Required on page 3.

Wattage

The unit of measurement used to quantify the rate or amount of electrical energy being used is the watt. One thousand watts is referred to as one kilowatt. Heating elements are rated in kilowatts expressed as KW. The higher the kilowatt rating of a heating element the more power it will use and the more heat it will generate. One kilowatt generates 3412 Btu of heat.

Ohms Law

A law that explains the relationship between voltage, current and resistance. The law states that the electric current flowing through a conductor is equal to the voltage divided by the resistance. The following equations further explain ohms law.

Ohms Law applied to “SINGLE PHASE” (1Ø) power:

- V = Volts (electrical pressure)
- A = Amps (electrical flow/current)
- O = Ohms (resistance to electrical flow/current)
- W = Watts (rate or amount of electricity used)

$V \div A = O$	$W \div V = A$	$V \div O = A$	$V \times A = W$	$A \times O = V$	$W \div A = V$
----------------	----------------	----------------	------------------	------------------	----------------

Service Note: Heating elements used on the water heaters covered by this manual are “two wire” single phase elements. Though the power supply to the water heater may be three phase, calculations to determine amperage and resistance for individual heating elements is based on ohms law applied to single phase power. The KW rating of individual heating elements is marked on the end of each element - see page 21. Approximate current (amps) and resistance (ohms) for individual heating elements are provided in tables on page 22.

See the water heater’s rating label for the listed voltage/phase power supply requirements, total input KW and total/full load amp draw of the water heater being serviced.

Calculating Amps/Ohms/Volts/Watts

Using a 240 volt electric water heater equipped with a 4500 watt heating element as an example Ohms Law can be used to determine:

- 1 What the resistance of each heating element should be:
 - $240 \text{ volts} \div 18.75 \text{ amps} = 12.8 \text{ ohms}$
- 2 What the correct amp reading should be:
 - $4500 \text{ watts} \div 240 \text{ volts} = 18.75 \text{ amps}$
 - $240 \text{ volts} \div 12.8 \text{ ohms} = 18.75 \text{ amps}$
- 3 How many watts are being used (how much heat is being generated):
 - $240 \text{ volts} \times 18.75 \text{ amps} = 4500 \text{ watts (4.5 KW)}$
- 4 What the voltage is:
 - $18.75 \text{ amps} \times 12.8 \text{ ohms} = 240 \text{ volts}$
 - $4500 \text{ watts} \div 18.75 \text{ amps} = 240 \text{ volts}$



SINGLE AND THREE PHASE POWER

The water heaters covered in this manual can be field converted for a single or three phase power supply - see pages 15 and 16. These water heaters can be factory ordered for standard North American power supplies; 277/208/240/480 volt models. 277 volt models are single phase only. Voltage conversion kits with instructions are available from the manufacturer - voltage conversions are not covered in this manual. Verifying the power supply is adequate is typical first step during most service diagnostic procedures. The illustrations and instructions that follow outline how this is done using a standard AC volt meter - see Tools Required on page 3.

Service Warning: Never touch any wiring inside the water heater until the main power supply to the water heater has been secured. Secure power to the water heater by turning off the power supply breaker and/or disconnect switch **AND** verify with a volt meter that all wiring has no voltage present before touching any wiring inside the water heater's control panel.

Service Warning: Zero or low voltage readings between internal wiring and/or Power Distribution Block terminals and ground can be due to an inadequate earth ground. **TREAT ALL WIRES AS BEING HOT** until it has been determined there is no voltage present.

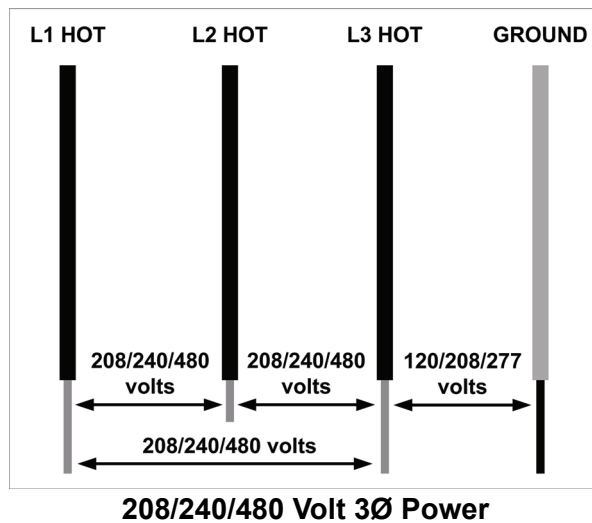
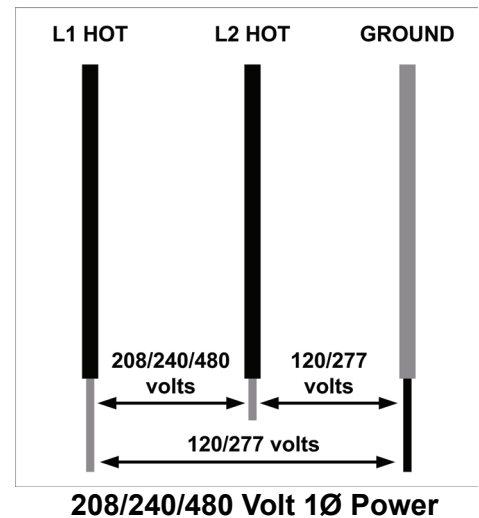
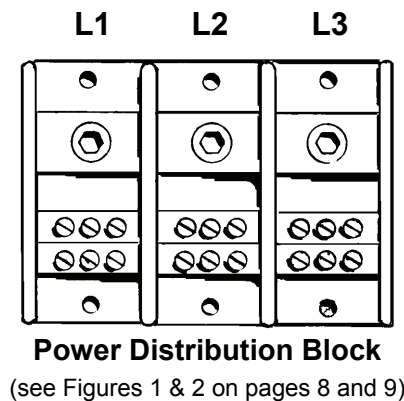
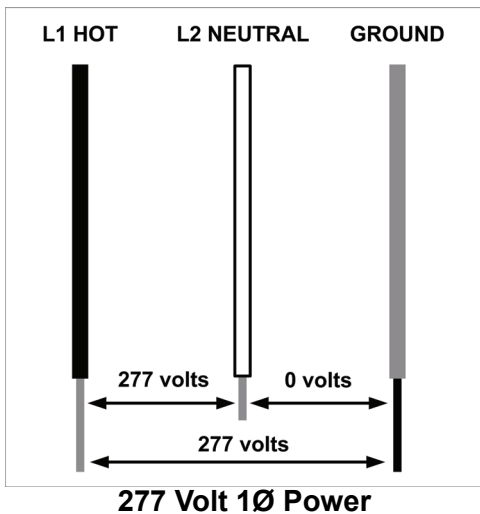

Checking Single Phase (1Ø) Power

A single phase power supply consists of two wires connected to the L1 and L2 terminals of the Power Distribution Block, the L3 terminal is not used. On a single phase (1Ø) 277 volt power supply one of the two wires is a “neutral” wire and does have voltage present. On a single phase (1Ø) 277 volt power supply the “hot” wire should be connected to the L1 terminal and the “neutral” wire should be connected to the L2 terminal. On 208, 240 and 480 volt power supplies both wires connected to L1 and L2 are “hot” with voltage present.

Voltage Between Terminals: With the power supply to the water heater turned on set the volt meter to an AC voltage range above the expected voltage (600 VAC or higher range initially) and carefully touch the two test probes to the L1 and L2 terminals of the water heater’s Power Distribution Block. The voltage readings should match the voltage listed on the water heater’s rating label by $\pm 5\%$.

Voltage to Ground: With the power supply to the water heater turned on check between the L1 terminal and the ground wire connection inside the water heater’s control panel. Check between L2 and ground in the same way. On a 277 volt power supply only one of the two terminals should read 277 volts, the neutral will read approximately zero volts. On 208/240 volt power supplies each reading should be approximately 120 volts to ground. On 480 volt power supplies each reading to ground should be approximately 277 volts.

Service Warning: Zero or low voltage readings between internal wiring and/or Power Distribution Block terminals and ground can be due to an inadequate earth ground. **TREAT ALL WIRES AS BEING HOT** until it has been determined there is no voltage present.

If the voltage readings taken between L1 and L2 are more than $\pm 5\%$ of the listed voltage on the water heater’s rating label or if the readings to ground were far less (at or near zero volts) than expected: check the fuses and the breaker and/or disconnect switch supplying power to the water heater. Contact a Qualified/Licensed electrician to restore power. If the voltage readings taken are a standard voltage (277/208/240/480) but do not match the listed voltage on the water heater’s rating label secure power to the water heater. **DO NOT** place it back in service. Contact the distributor and/or manufacturer to determine if the water heater can be field converted and/or replaced to match the power supply at the location.

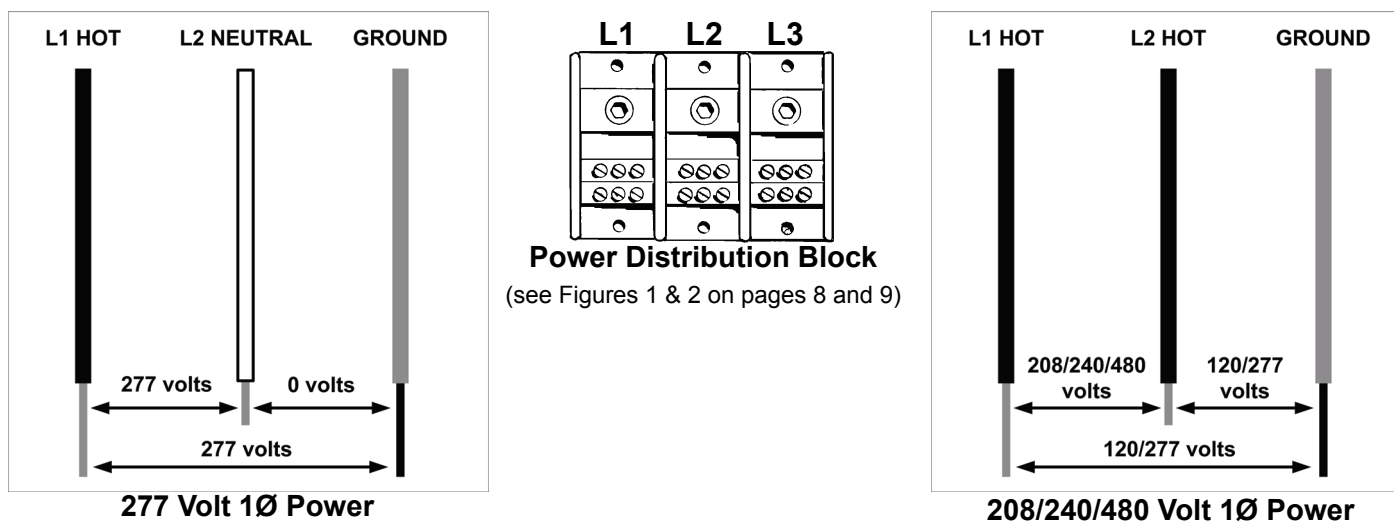

Checking Three Phase (3Ø) Power

A three phase power supply consists of three wires connected to the L1, L2 and L3 terminals of the Power Distribution Block. All three wires are “hot” with voltage present.

Voltage Between Terminals: Set the volt meter to an AC voltage range above the expected voltage (600 VAC or higher range initially). Checking three phase (3Ø) power requires that three voltage readings be taken between all possible pairings of the terminals on the Power Distribution Block. Carefully touch the two test probes between:

- 1 L1 and L2 terminals of the water heater’s Power Distribution Block
- 2 L2 and L3 terminals of the water heater’s Power Distribution Block
- 3 L1 and L3 terminals of the water heater’s Power Distribution Block

All three voltage readings should match the voltage listed on the water heater’s rating label by $\pm 5\%$.

Voltage to Ground: Check between each of the three terminals (L1, L2 and L3) of the Power Distribution Block and the ground wire connection inside the water heater’s control panel. On some 208 volt power supplies each reading will be approximately 120 volts to ground. Some 208 volt models will have a “stinger leg” with one of the three readings to ground measuring 208 volts - 208 volt stinger legs should be connected to L2. On 240 volt power supplies each reading should be approximately 120 volts to ground. On 480 power supplies each reading to ground should be approximately 277 volts.

Service Warning: Zero or low voltage readings between internal wiring and/or Power Distribution Block terminals and ground can be due to an inadequate earth ground. **TREAT ALL WIRES AS BEING HOT** until it has been determined there is no voltage present.

If the voltage readings taken between L1, L2 and L3 are more than $\pm 5\%$ of the listed voltage on the water heater’s rating label or if the readings to ground were far less (at or near zero volts) than expected: check the fuses and the breaker and/or disconnect switch supplying power to the water heater. Contact a Qualified/Licensed electrician to restore power. If the voltage readings taken are a standard voltage (277/208/240/480) but do not match the listed voltage on the water heater’s rating label secure power to the water heater. **DO NOT** place it back in service. Contact the distributor and/or manufacturer to determine if the water heater can be field converted and/or replaced to match the power supply at the location.

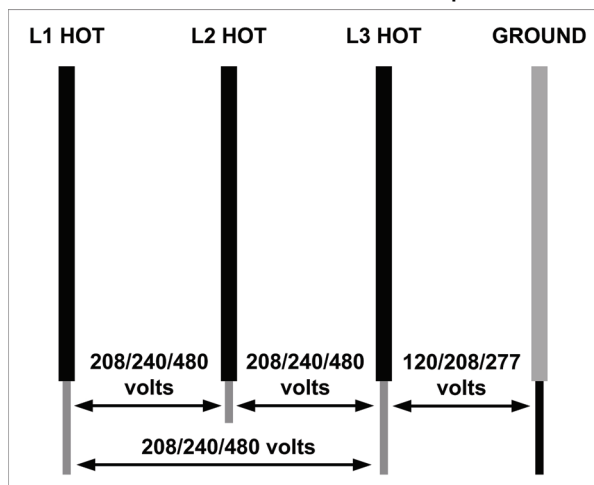

208/240/480 Volt 3Ø Power

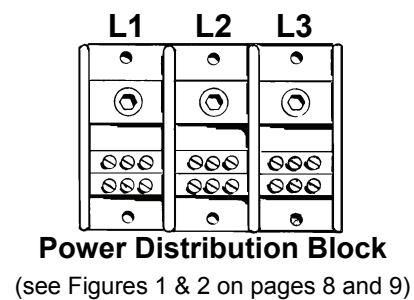

PHASE CONVERSIONS - SURFACE MOUNT CONTROL MODELS

Internal wiring connections between the Power Distribution Block and the heating elements are different on Surface Mount Control (see Figure 1 page 8) and Electronic Control (see Figure 2 page 9) model water heaters. Because of these differences there are two methods for field converting these models to work with single and three phase power supplies.

Service Note: 208 volt 54 KW models are 3 phase only and CAN NOT be converted to single phase. All other models can be phase converted.

SECURE MAIN POWER SUPPLY TO THE WATER HEATER AT THE MAIN BREAKER OR DISCONNECT SWITCH FIRST.

Service Warning: Never touch any wiring inside the water heater until the main power supply to the water heater has been turned off. Verify with a volt meter that all wiring has no voltage present before touching any wiring inside the water heater's control panel.

Surface Mount Control Models Three Phase to Single Phase

- 1 Disconnect blue wires from terminal L-2.
- 2 Connect all blue wires to terminal L-1 (with black wires).
- 3 Disconnect all red wires from terminal L-3.
- 4 Connect all red wires to terminal L-2 (with yellow wires).
- 5 Incoming power will be connected to terminals L-1 and L-2.

Service Note: 208 volt 54 KW models are three phase only - these models CAN NOT be converted to single phase. Keep in mind when converting other models from three phase power to single phase power the current/ampereage will increase significantly - ensure breakers, fuses and wiring are properly sized to allow for the increased ampereage before placing the water heater back in service. Contact a Qualified/Licensed electrician to make necessary changes.

Power Distribution Block
(see Figure 1 on page 8)

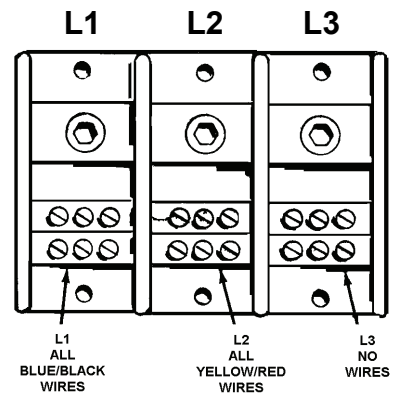

Surface Mount Control Models Single Phase to Three Phase

- 1 Disconnect blue wires from terminal L-1
- 2 Disconnect red wires from terminal L-2.
- 3 Connect all blue wires to terminal L-2 (with yellow wires).
- 4 Connect red wires to terminal L-3.
- 5 Incoming power will be connected to terminals L-1, L-2 and L-3.

Service Note: Keep in mind when converting from single phase power to three phase power the current/ampereage will decrease significantly - ensure breakers and fuses are not oversized before placing the water heater back in service. Contact a Qualified/Licensed electrician to make necessary changes.

Power Distribution Block
(see Figure 1 on page 8)

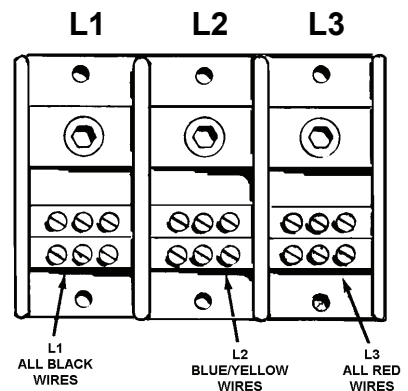

PHASE CONVERSIONS - ELECTRONIC CONTROL MODELS

Internal wiring connections between the Power Distribution Block and the heating elements is different on Surface Mount Control (see Figure 1 page 8) and Electronic Control (see Figure 2 page 9) model water heaters. Because of these differences there are two methods for field converting these models to work with single and three phase power supplies.

Service Note: 208 volt 54 KW models are 3 phase only and CAN NOT be converted to single phase. All other models can be phase converted.

SECURE MAIN POWER SUPPLY TO THE WATER HEATER AT THE MAIN BREAKER OR DISCONNECT SWITCH FIRST.

Service Warning: Never touch any wiring inside the water heater until the main power supply to the water heater has been turned off. Verify with a volt meter that all wiring has no voltage present before touching any wiring inside the water heater's control panel.

Electronic Control Models

Three Phase to Single Phase

- 1 Disconnect blue wires and yellow wires from terminal L-3.
- 2 Connect all blue wires to terminal L-1 (with black wires).
- 3 Connect all yellow wires to terminal L-2 (with red wires).
- 4 Incoming power will be connected to terminals L-1 and L-2.

Service Note: 208 volt 54 KW models are three phase only - these models CAN NOT be converted to single phase. Keep in mind when converting other models from three phase power to single phase power the current/amperage will increase significantly - ensure breakers, fuses and wiring are properly sized to allow for the increased amperage before placing the water heater back in service. Contact a Qualified/Licensed electrician to make necessary changes.

Power Distribution Block
(see Figure 2 on page 9)

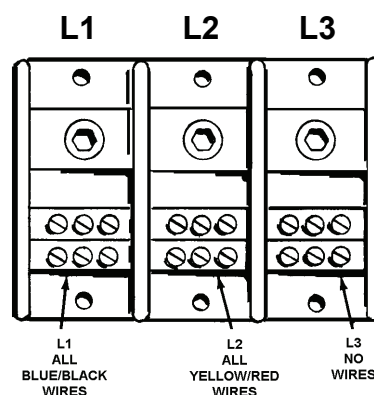

Electronic Control Models

Single Phase to Three Phase

- 1 Disconnect blue wires from terminal L-1.
- 2 Disconnect yellow wires from terminal L-2.
- 3 Connect all blue wires and yellow wires to terminal L-3.
- 4 Incoming power will be connected to terminals L-1, L-2 and L-3.

Service Note: Keep in mind when converting from single phase power to three phase power the current/amperage will decrease significantly - ensure breakers and fuses are not oversized before placing the water heater back in service. Contact a Qualified/Licensed electrician to make necessary changes.

Power Distribution Block
(see Figure 2 on page 9)

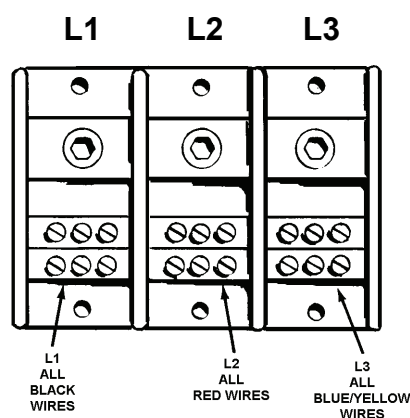

FUSES

The water heaters covered in this manual have power circuit fuses to protect the heating element circuits. Electronic Control models will have two additional fuses to protect the primary winding of the 120 Volt Control Circuit Transformer. See Figures 1 and 2 on pages 8 and 9 for location. Testing fuses requires an ohm meter, an AC volt meter and an insulated fuse puller - see Tools Required page 3.

Service Note - Replacement Fuses: Replacement power circuit fuses MUST BE of the same value and type as the factory installed fuses - Class G/SC-30 Amp/Time Delay. Replacement 120 Volt Control Circuit Transformer fuses MUST BE of the same value and type as the factory installed fuses - Class G/SC-3 Amp.

Ohm Meter Method

- 1 Secure power to the water heater at the main breaker or disconnect switch.
- 2 Remove each fuse to be tested with an insulated fuse puller.
- 3 Set the Ohm meter to it's lowest resistance range (< 200) or to an audible beep continuity test setting if so equipped.
- 4 Touch the meter probes to both ends of each fuse simultaneously.
- 5 If the fuse being tested shows a low resistance (< 1 ohms) or the continuity test feature sounds an audible beep the fuse being tested is good and can be re-installed.
- 6 If the fuse being tested shows infinite resistance (open circuit) or the continuity test feature does not sound an audible beep the fuse being tested is blown and must be replaced.

Ohm Meter Method

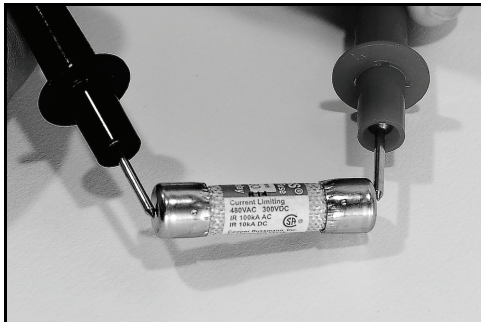

Volt Meter Method

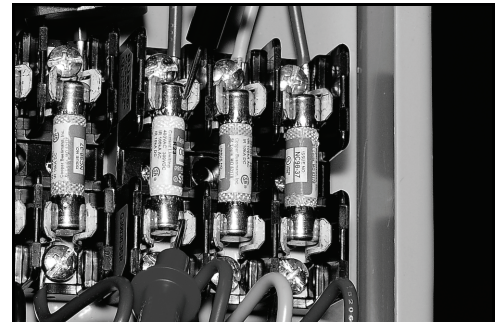

Volt Meter Method

Fuses can also be checked using an AC volt meter. The power supply must be turned on and a call for heat must be active (all thermostats/contactors must be closed) during this test. Touch the two test probes to both ends of all fuses while still in their fuse blocks.

- A high voltage (at or above 120 VAC) reading indicates the fuse is blown.
- A zero volt reading generally indicates the fuse is good. Next check for voltage between each end of the fuse and ground to ensure voltage is present at both ends of the fuse. If no voltage is present between either end of the fuse and ground the test has not been conclusive - secure power to the water heater and perform the ohm meter test method described above.

The voltage test method is a good way to quickly identify fuses that are blown but it is not always conclusive due to the dependence on power being present at both ends of the fuse, the switch contacts in thermostats/contactors being closed and correct wiring. Keep this in mind as there may be times when a fuse that is blown tests good due to one of these dependencies not being met. The ohm meter method described above is 100% conclusive.

SURFACE MOUNT THERMOSTATS

The Surface Mount Control Model water heaters covered in this manual have “separate” thermostat/ECO (energy cut out) combination controls mounted to the surface of the storage tank directly above the heating elements they control. IE: a water heater equipped with 9 heating elements will have 9 thermostat/ECO controls. These controls contain two bimetal thermal switches that react to heat sensed from the surface of the water heater’s storage tank.

Thermostat: The thermostat portion of these controls is an automatic SPST (single pole single throw) switch - see the Internal Wiring illustration below. As the tank (water) temperature rises and falls each individual thermostat will de-energize (contact opens) and energize (contact closes) one heating element according to it’s temperature setting. The temperate setting is adjustable using the dial on the lower portion of the control. The adjustable range is 120°F/49°C to 180°F/82°C. The factory default setting is 140°F/60°C.

ECO: The ECO portion of these controls is a manual reset DPDT (double pole double throw) switch - see the Internal Wiring illustration below. The ECO is a high temperature limit switch designed to protect against excessively high water temperatures that can be caused by defective thermostats and grounded heating elements. The ECO temperature setting is non adjustable and fixed at 200°F/93°C. If the ECO activates (contacts open) in response to abnormally high temperatures the contacts will not close automatically, the ECO must be manually reset by pressing the red button on the top of the control. The tank temperature must cool to approximately 120°F/49°C before the ECO can be reset. When activated (contacts open) the ECO will interrupt all power supplied to the thermostat portion of the control and the heating element.

THERMOSTAT/ECO FRONT VIEW

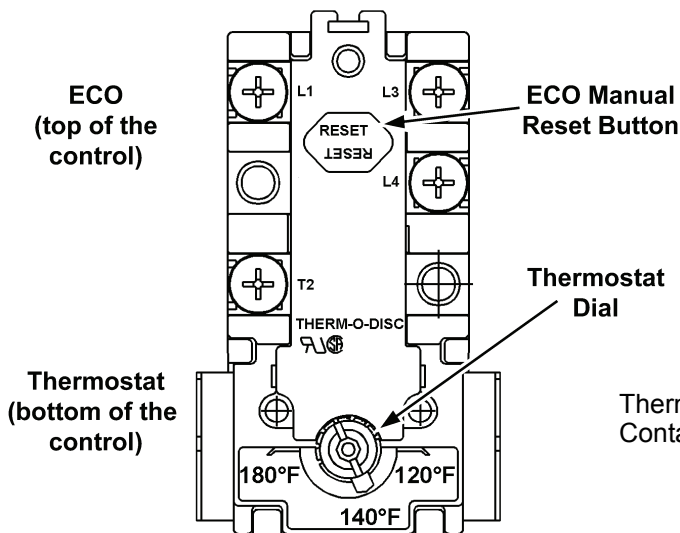

THERMOSTAT/ECO INTERNAL WIRING

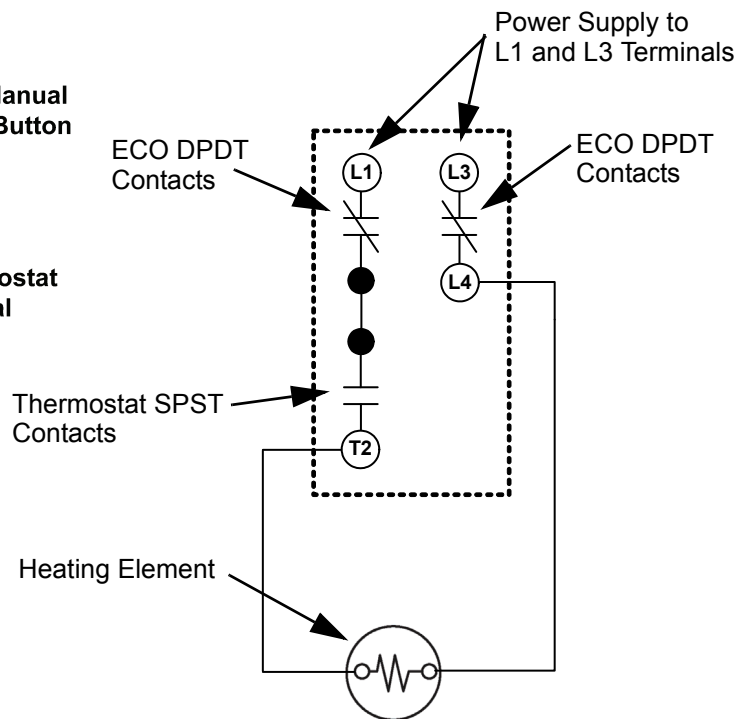

Thermostat & ECO Test

- 1 Secure power to the water heater at the main breaker or disconnect switch.
- 2 Ensure tank temperature is less than 100°F/38°C - dump water to lower tank temperature if necessary.
- 3 Press the red reset button firmly on all thermostat/ECO controls.
- 4 Raise the temperature setting on all thermostat/ECO controls to 140°F or higher.
- 5 Restore power to the water heater.
- 6 With an AC volt meter check for voltage between the L1 and L3 terminals on the control - see illustrations below. Measured voltage should match the power supply to the water heater.

Service Note: If the measured voltage is zero volts or not the correct voltage ensure heating element power circuit wiring is correct (see wiring diagram on water heater) check fuses (page 17) and/or restore power to the water heater - see pages 12 - 14.

- 7 With an AC volt meter check for voltage between the L4 and T2 terminals on the control - see illustrations below - if the measured voltage matches the power supply to the water heater the ECO is resetting properly. If the measured voltage between L4 and T2 is low or not present the control is defective - replace the control.

Service Note: Grounded heating elements, defective thermostats and/or a defective ECOs can all cause frequent ECO activation. If an ECO is being frequently reset on any of the thermostat/ECO controls check all heating elements to ensure they are not grounded (see page 26) first. Replace any grounded elements. If no elements are grounded replace the thermostat/ECO control(s) that require frequent resetting.

STEP 6 CHECKING POWER TO THE CONTROL

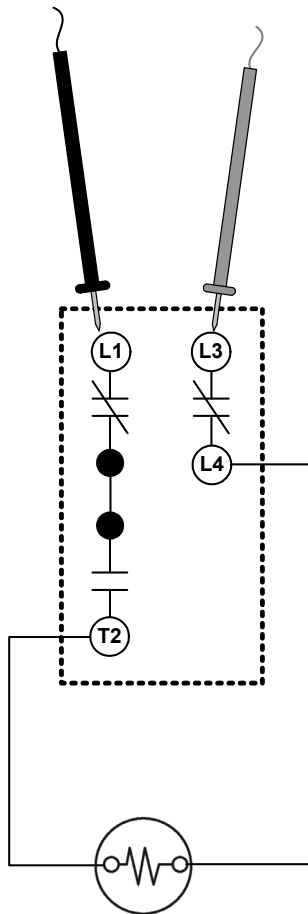

STEP 7 CHECKING POWER TO THE HEATING ELEMENT

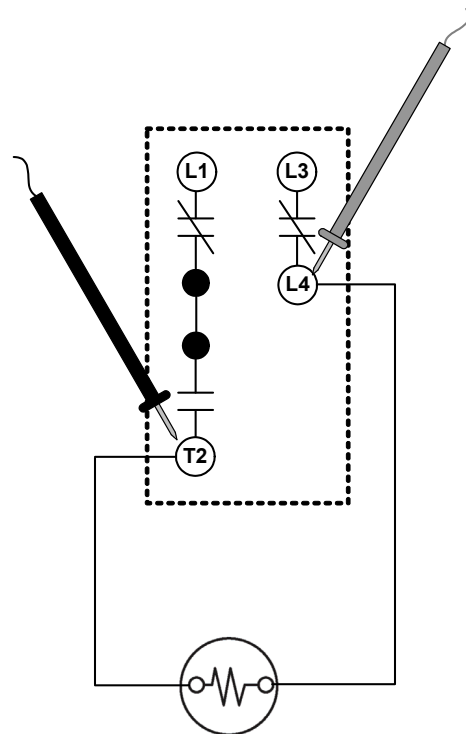

HEATING ELEMENTS

This section of the manual provides information on how to determine the actual voltage and wattage rating of a heating element along with tables showing heating element configurations, heating element amperage and heating element resistance/ohms.

This section also contains heating element test procedures to measure; amperage, voltage, resistance and check for grounded elements. These procedures are used to determine if a heating element is defective or working properly. An AC amp meter, AC volt meter and ohm meter are required - see Tools Required on page 3.

Heating Element Construction

The water heater(s) covered in this manual use electric heating elements to heat water. Heating elements convert electrical energy into heat energy.

Heating elements are constructed with metal tubing. Inside the tube is a wire conductor surrounded by an insulating material. The wire conductor inside the heating element has a relatively high resistance to the flow of electricity. Heat is generated when the electricity (*voltage*) applied to the heating element begins to flow (*amperage*) and encounters the resistance (*ohms*) of the wire conductor inside.

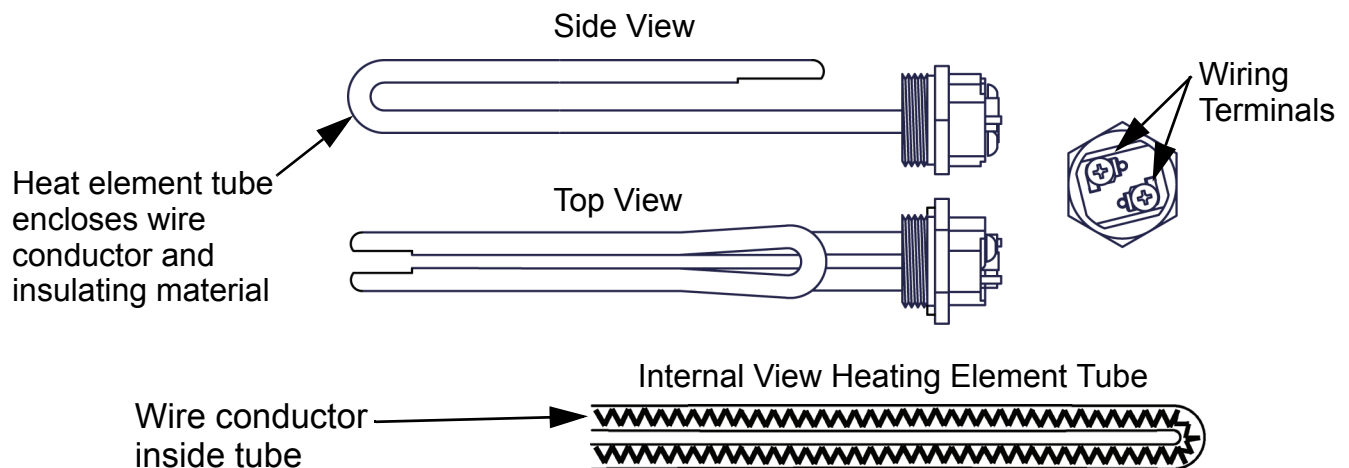

Heating Element Ratings

Heating elements are labeled with their voltage and KW rating - see image below. The element shown here is a 6000 watt (6 KW) 240 volt element.

Wattage and Voltage Ratings

Note: some heating elements are dual rated elements
IE: 208/240 volts

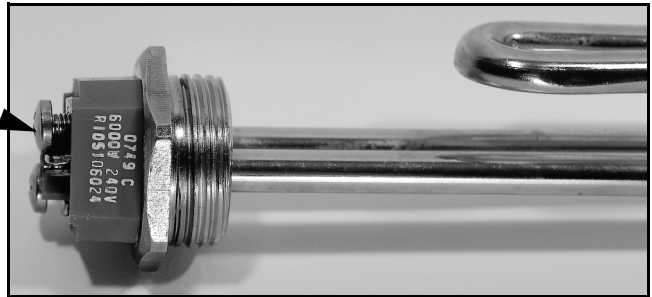

Heating Element Configurations

The table below shows how many heating elements are installed at the factory and the wattage of each heating element according to the rated voltage of the water heater. The table below represents all available tank sizes; 50, 80 and 120 gallon models.

Service Note: 208 volt 18 KW models are only available with six 3000 watt elements and 208 volt 36 KW models are only available with nine 4000 watt heating elements.

TOTAL WATER HEATER INPUT KW	HEATING ELEMENT WATTAGE	NUMBER OF FACTORY INSTALLED HEATING ELEMENTS	
		208 VAC	240 / 277 / 480 VAC
6	2000	3	3
9	3000	3	3
12	4000	3	3
13.5	4500	3	3
15	5000	3	3
18	6000	N/A	3
18	3000	6	6
24	4000	6	6
27	4500	6	6
30	5000	6	6
36	6000	N/A	6
36	4000	9	9
40.5	4500	9	9
45	5000	9	9
54	6000	9	9

Heating Element Amperage

This table shows the approximate amp draw for the various heating elements used. First determine the actual rated wattage and voltage of the element being tested - see Heating Element Ratings on page 21. Then follow the Heating Element Amperage Test procedure on page 23 to measure amperage at each heating element. Compare the measured value to the values in the table below. Keep in mind there may be some variance between measured values and the values in this table due to fluctuations in voltage, temperature and the calibration of test instruments being used.

ELEMENT WATTAGE	APPROXIMATE CURRENT - AMPS			
	208 VAC	240 VAC	277 VAC	480 VAC
2000	9.62	8.33	7.22	4.17
3000	14.42	12.50	10.83	6.25
4000	19.23	16.67	14.44	8.33
4500	21.63	18.75	16.25	9.38
5000	24.04	20.83	18.05	10.42
6000	28.85	25.00	21.66	12.50

Service Note - Correct Elements: If the measured amp draw on any element is considerably less or more than the values given in the table above check the element rating to ensure it matches the water heater’s factory configuration - see Heating Element Ratings and Heating Element Configurations on page 21. All heating elements should have the same voltage and KW rating in a water heater. If an element is not the correct rating for the water heater being serviced it must be replaced with a properly rated heating element.

Service Note - Grounded Elements: Grounded elements on Surface Mount Control Models (Figure 1 page 8) can draw low amps because power is continuously present at one terminal on each element - see the wiring diagram on page 18. Power from the thermostat’s L4 terminal is always present at each element and can flow from a grounded element through the water to the storage tank. If the measured amps are considerably less than the values in the table above test those elements for grounding - see page 25.

Heating Element Resistance

This table shows the approximate resistance (in ohms) for the various heating elements used. First determine the actual rated wattage and voltage of the element being tested - see Heating Element Ratings on page 21. Then follow the Measuring Resistance Test procedure on page 25 to measure the resistance of each heating element. Compare the measured value to the values in the table below. Keep in mind there will be some variance between measured values and the values in this table due to fluctuations in temperature and the calibration of test instruments being used.

ELEMENT WATTAGE	APPROXIMATE RESISTANCE - OHMS			
	208 VAC	240 VAC	277 VAC	480 VAC
2000	21.63	28.80	38.36	115.20
3000	14.42	19.20	25.58	76.80
4000	10.82	14.40	19.18	57.60
4500	9.61	12.80	17.05	51.20
5000	8.65	11.52	15.35	46.08
6000	7.21	9.60	12.79	38.40



Heating Element Amperage Test

This test should be considered as a first diagnostic procedure for the common service complaints of no hot water or not enough hot water. The heating element amperage test shown on this page is the best procedure to quickly determine which (if any) heating elements are not working properly.

- 1 Secure power to the water heater at the main breaker or disconnect switch.
- 2 Ensure tank temperature is less than 100°F/38°C - dump water to lower tank temperature if necessary.
- 3 **Surface Mount Control Models** - raise the temperature settings to ensure a call heat is active for all heating elements. Press the red reset button firmly on all thermostat/ECO controls then raise the temperature setting on all thermostat/ECO controls to 140°F or higher - see page 18.
- 4 Restore power to the water heater.
- 5 **Electronic Control Models** - adjust the temperature settings to ensure a call heat is active for all heating elements. Raise the Operating Set Point in the Temperatures Menu to 140°F or higher. Set all Heating Element Bank Differentials in the Temperatures Menu to 2°F - see pages 52 and 53.
- 6 Using a clamp style AC amp meter: set the amp meter to an AC amperage range just above the expected amperage (100 AC amp range initially). Measure and record the amperage at all heating elements by clamping the jaws of the meter around **ONLY** one of the wires to each heating element. See the image below. Heating element amp readings should be approximately the same for all heating elements. The normal operating amps for all heating elements is provided in the Heating Element Amperage table on page 22 or it can be calculated using ohms law as explained on page 11.

Service Note: Check all power circuit wiring to the heating element(s) on any element drawing zero or low amps - see the wiring diagram on the water heater. On Electronic Control Models check the contactors on any heating element(s) drawing zero or low amps - see pages 29 - 33. Perform the Heating Element Voltage and Heating Element Resistance & Ground tests (see pages 24 - 26) on any heating elements drawing zero amps or any heating element drawing less than normal operating amps.

If the measured amp draw on any element is considerably less or more than the normal operating amps ensure the voltage and KW rating of those heating elements is the correct value for the water heater being serviced - see Heating Element Ratings and Heating Element Configurations on page 21.

Measuring amperage on an electric heating element. Make sure the jaws of the AC amp meter are clamped around **ONLY ONE WIRE** to the heating element being tested. Clamping around more than one wire often gives a false zero amp reading.

DO NOT TOUCH THE ENDS OF ANY HEATING ELEMENTS WHILE PERFORMING THIS TEST

Be extremely careful as there will be high voltage present at the wiring terminals on all heating elements during this test.



Heating Element Voltage Test

This test is typically performed after an amperage test (see page 23) has determined one or more heating elements is not drawing correct amperage.

- 1 Secure power to the water heater at the main breaker or disconnect switch.
- 2 Ensure tank temperature is less than 100°F/38°C - dump water to lower tank temperature if necessary.
- 3 **Surface Mount Control Models** - raise the temperature settings to ensure a call heat is active for all heating elements. Press the red reset button firmly on all thermostat/ECO controls then raise the temperature setting on all thermostat/ECO controls to 140°F or higher - see page 18.
- 4 Restore power to the water heater.
- 5 **Electronic Control Models** - adjust the temperature settings to ensure a call heat is active for all heating elements. Raise the Operating Set Point in the Temperatures Menu to 140°F or higher. Set all Heating Element Bank Differentials in the Temperatures Menu to 2°F - see pages 52 and 53.
- 6 Using an AC volt meter; set the volt meter to an AC voltage range above the expected voltage (600 VAC or higher range initially).
- 7 Check voltage between the two terminals on the heating element - see the image below. Record the voltage at all heating elements. Voltage should match the listed voltage on the water heater's rating label.
- 8 If the measured voltage is zero volts or is not the correct voltage - check power to the water heater (pages 12 - 14), check fuses (page 17). Ensure heating element power circuit wiring is correct (see wiring diagram on water heater). Check thermostat/ECO control(s) supplying power to the heating element on Surface Mount Control models - see page 19. Check contactors on Electronic Control Models (see pages 29 - 33). Check all wiring and connections between the heating elements, contactors, fuses and the power distribution block. Ensure all wiring and connections are tight and making good contact - replace any wiring, fuses and/or contactors that are not working properly, damaged or show signs of excessive wear.

Measuring voltage on an electric heating element.
Touch the two volt meter probes to the two terminals on the end of each heating element.

DO NOT TOUCH THE ENDS OF ANY HEATING ELEMENTS WHILE PERFORMING THIS TEST

Be extremely careful as there will be high voltage present at the wiring terminals on all heating elements during this test.



Heating Element Resistance & Ground Tests

This is a two part test. In the first part of this test the actual resistance (ohms) of each heating element is measured. In the second part of this test each heating element is tested for any continuity to ground to ensure the heating element is not shorted to ground. These tests should be considered as third and fourth diagnostic procedures to be performed whenever the results from the Heating Element Amperage Test showed a heating element was not drawing the correct amps AND the results from the Heating Element Voltage Test showed the element had the proper voltage applied.

Measuring Resistance

- 1 Determine what the actual voltage and KW rating is for the heating elements in the water heater being serviced - see Heating Element Ratings and Heating Element Configurations on page 21. Replace any elements that are not the proper rating for the water heater being serviced.
- 2 Secure power to the water heater at the main breaker or disconnect switch.
- 3 Verify with an AC volt meter that there is not any voltage present at the Power Distribution Block (see Figures 1 and 2 on pages 8 and 9) and at the two wiring terminals on the ends of all heating elements.
- 4 Disconnect both power wires from the terminals on the top of all heating elements to be tested.
- 5 Using an ohm meter: set the ohm meter to a range just above the expected ohms (200 ohm range initially).
- 6 Touch the ohm meter probes between the two terminals on each heating element - see the image below. Measure and record the resistance (ohms) at all heating elements being tested.
- 7 Compare the resistance value (ohms) measured to the values given in the Heating Element Resistance table on page 22.
- 8 If the measured resistance (ohms) matches the values in the Heating Element Resistance table on page 22 the heating element resistance is correct.
- 9 If the resistance reading is infinite - no continuity at all between the two terminals - the heating element is defective and must be replaced. During heating element replacement be sure to check fuses (page 17), inspect contactors on Electronic Control Models (see page 31) and check all wiring and connections between the heating elements, contactors, fuses and the power distribution block. Ensure all wiring and connections are tight and making good contact - replace any wiring, fuses, contactors that are damaged or show signs of excessive wear.

Measuring resistance (ohms) on an electric heating element. Touch the two ohm meter probes to the two terminals on the end of each heating element.



Heating Element Ground Test

- 1 Secure power to the water heater at the main breaker or disconnect switch.
- 2 Verify with an AC volt meter that there is not any voltage present at the Power Distribution Block (see Figures 1 and 2 on pages 8 and 9) and at the two wiring terminals on the ends of all heating elements.
- 3 Disconnect both power wires from the terminals on the top of all heating elements to be tested.
- 4 Using an ohm meter: set the ohm meter to one of it's lowest resistance ranges - 200 ohms or less initially. An audible beep continuity test setting can also be used on ohm meters so equipped.
- 5 Touch one of the ohm meter probes to one of the two heating element wiring terminals and the other probe to a grounded surface on the water heater such as the water heater's storage tank (use sand cloth if necessary to remove any coating that may prevent metal to metal contact) or the water heater ground wire connection. Check between the other heating element terminal and ground also - see the image below.
- 6 If there is infinite resistance - no continuity - between both heating element wiring terminals and ground the heating element(s) is not grounded.
- 7 If there is any resistance measured - there is continuity - between either heating element wiring terminal and ground the heating element is defective and must be replaced. Ensure the voltage and KW rating of the replacement heating element is the correct rating for the water heater being serviced - see Heating Element Ratings and Heating Element Configurations on page 21.

Checking an electric heating for any resistance or continuity to ground. Touch one of the ohm meter probes to one terminal on the end of a heating element and the other probe to a grounded surface on the water heater.

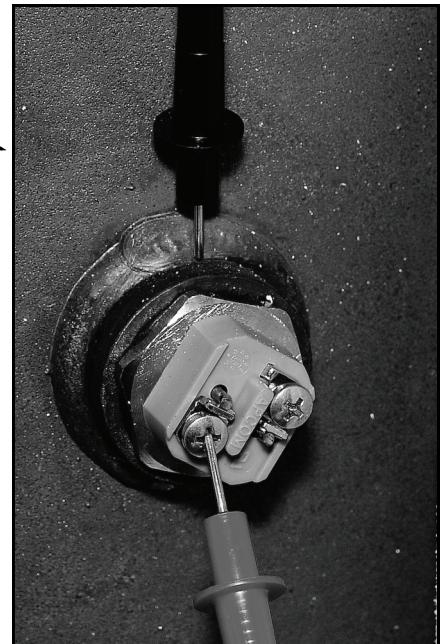

Replacing Heating Elements

- 1 Secure power to the water heater at the main breaker or disconnect switch.
- 2 Verify with an AC volt meter that there is not any voltage present at the Power Distribution Block (see Figures 1 and 2 on pages 8 and 9) and at the two wiring terminals on the ends of all heating elements.
- 3 Disconnect both power wires from the terminals on the top all heating elements being replaced.
- 4 Drain the water heater - follow the draining instructions in the Maintenance Section of Instruction Manual that came with the water heater. If the Instruction Manual is not available copies can be obtained from the manufacturers web site or by calling the toll free phone number on the back cover of this manual.
- 5 Remove/install heating elements using a 1 1/2" six point socket. Install a new heating element gasket with the new element. Replacement elements and gaskets can be obtained from local distributors or by calling the toll free phone number on the back cover of this manual.

ELEMENT SENSORS

Electronic Control Models covered in this manual monitor all heating elements using Element Sensors. Each Element Sensor monitors 3 heating elements. There will be one Element Sensor for each Bank of heating elements. See Figure 2 on page 9 and the illustration on page 30. Water heaters equipped with 3 heating elements will have 1 Element Sensor, water heaters equipped with 6 elements will have 2 Element Sensors and water heaters equipped with 9 elements will have 3 Element Sensors.

Element Sensor Construction

Element Sensors consists of 3 individual current sensors, a 10 conductor plug and 9 wires that connect between the individual current sensors and the plug. Each current sensor monitors one heating element. Current sensors are enclosed in a black plastic housing that has a hole in the middle. One power wire to each heating element is routed through the hole in one of the current sensors. See the images below.

Element Sensor

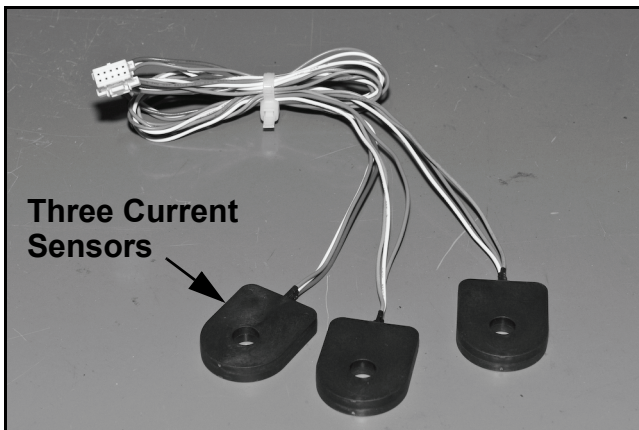

10 Conductor Plug

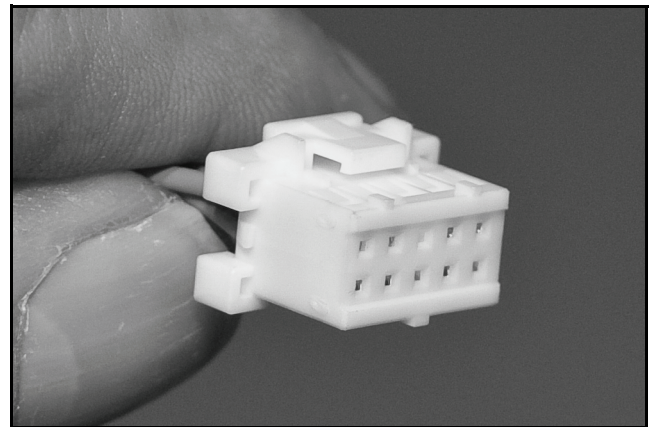

Element Sensor Functions

Working with the Element Sensors the electronic control system provides valuable operational and diagnostic information to aid in servicing:

The electronic control system displays animated Status Icons on the UIM to indicate which heating elements are being energized and which heating elements are not being energized. The Status Icons are also capable of indicating when a heating element that should be energized is not drawing current/amps. See the Status Icons Table on page 50.

The electronic control system displays a "No Current Detected" Alert message on the UIM (see pages 47 - 49) if the control system does not sense current (amperage) from a heating element when expected. IE: a call for heat is active, all contactor coils have been energized and the control system is not sensing current from one or more heating elements.

During Alert conditions the control system allows the water heater to continue heating (other elements may still be working) but prompts the user to have the water heater serviced.

Element Sensor Operation

When current (amperage) flows through a wire in an electrical circuit a magnetic field is developed that radiates out from the wire. The individual current sensors detect this magnetic field. When current flows in a wire routed through the hole in one of the individual current sensors, the sensor is activated and sends a signal back to the CCB confirming the presence of current.

The current sensors require approximately 3 AC amps minimum to activate. An active signal from a current sensor only indicates current has been sensed, it DOES NOT indicate the amount or level of current is correct for a given heating element.

As explained on the previous page Element Sensors contain three individual current sensors. The three sensors are installed just above the power circuit fuse blocks. One heating element power wire is routed through a hole in one sensor.

The plug from each Element Sensor plugs into one of three sockets on the CCB. The J12, J13 and J14 sockets are for heating element Banks 1, 2 and 3 respectively. See the images below.

Service Note: The Element Sensors cannot be serviced in the field. If it is determined one of the three individual current sensors in an Element Sensor is defective the entire Element Sensor assembly must be replaced. If current through a heating element has been verified with an AC amp meter (see page 23) and the current sensor for that element does not activate and send a signal to the CCB:

- Ensure the Element Sensor plug and socket connection is making good contact.
- On models equipped with 2 or 3 Banks of heating elements secure power to the water heater and try switching Element Sensor plugs between the J12, J13 and J14 sockets to verify the Element Sensor is defective - a "No Current Detected" Alert message and Status Icon indication should "follow" the defective Element Sensor and report a different heating element is not drawing current when current is expected.

CCB Element Sensor Sockets

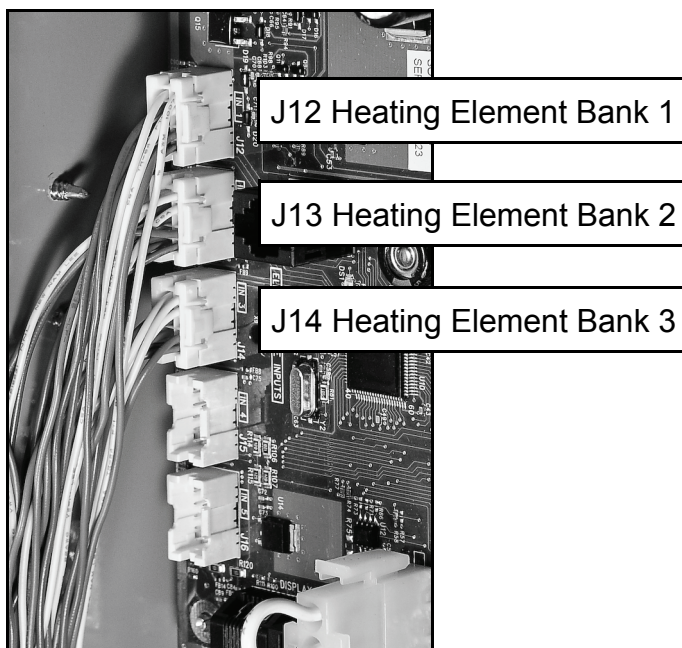

Heating Element Wire Routing

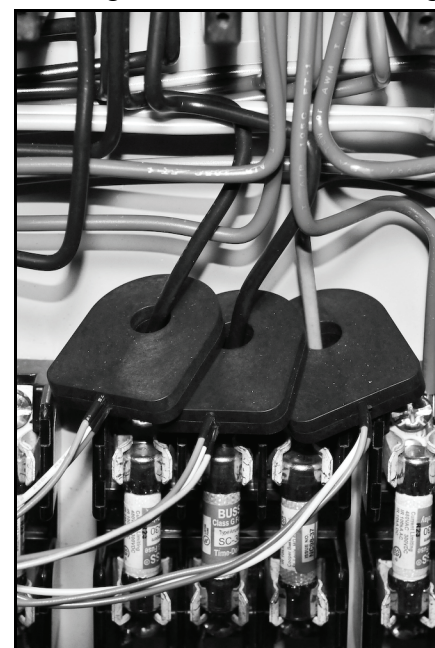

CONTACTORS

This section of the manual provides information on how contactors used on Electronic Control Models are constructed, how they work and how to test contactor operation - see Figure 2 on page 9 for location of the contactors on these models. Surface Mount Control Models are not equipped with contactors.

Contactor Construction - How They Work

Magnetic contactors are used on Electronic Control Models to energize and de-energize the heating elements. Power from the fuse blocks is supplied to the heating elements through three switches (3 poles) inside the contactor. Springs located inside the contactor hold the switch contacts open; the springs are compressed and the spring tension forces or holds the switch contacts in their normally open state.

The contactor's switches are closed by an electromagnetic coil inside the base of the contactor. When a call for heat is activated the electronic control system sends 120 volts to the contactor's electromagnetic coil. As current runs through the coil it becomes "magnetized" and overcomes the spring tension holding the switch contacts open. The switch contacts then close which in turn sends power to the heating elements. When the call for heat is satisfied the control system de-energizes the contactor coil and spring tension returns the contacts to their open position.

3 Pole Contactor Side View

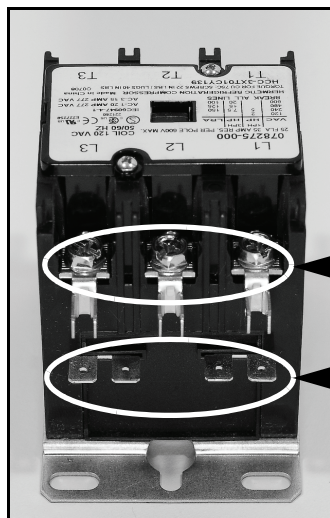

3 Pole Contactor Internal Wiring

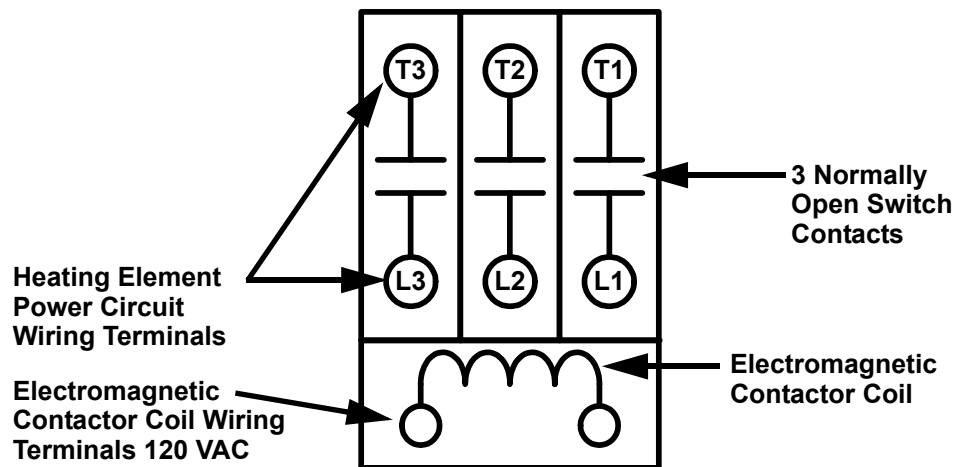

3 Pole Contactor Side View - Cover Plate Removed

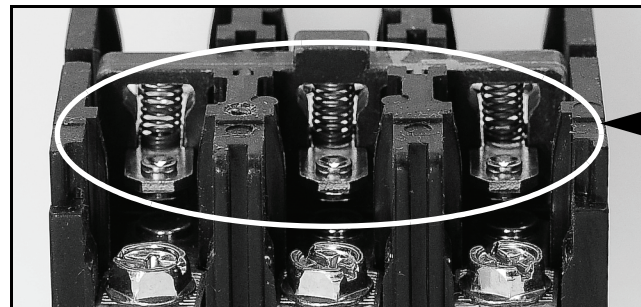

Contactor Springs Hold Contacts Open When Electromagnetic Coil Is Not Energized

Contactor Configurations

This illustration shows how contactors are configured and how they provide power to the heating elements on Electronic Control Model water heaters. This is a redundant contactor configuration - two contactors must close their contacts to energize any heating element. Elements and Banks are numbered according to how the control system monitors them - see Element Sensors pages 27 and 28. There are two contactors installed for each Bank. IE: the illustration shows a 9 element configuration, a water heater factory equipped with 6 heating elements would have 4 contactors and a water heater with 3 elements would have 2 contactors. Wiring is shown for the first two heating elements in Bank 1 only for simplicity.

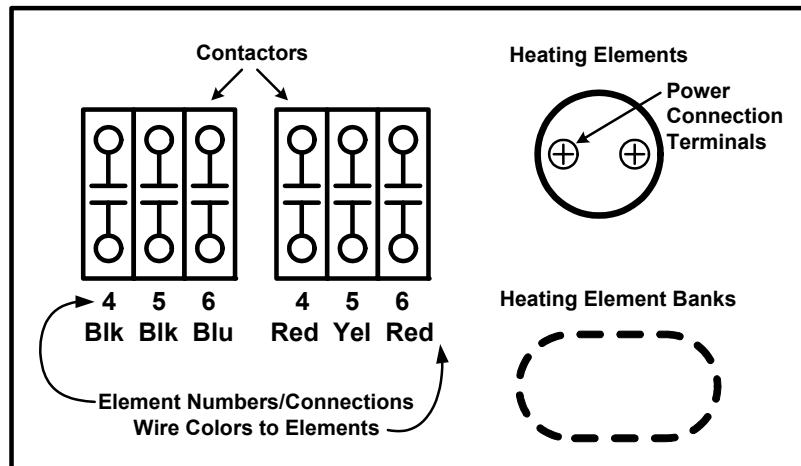
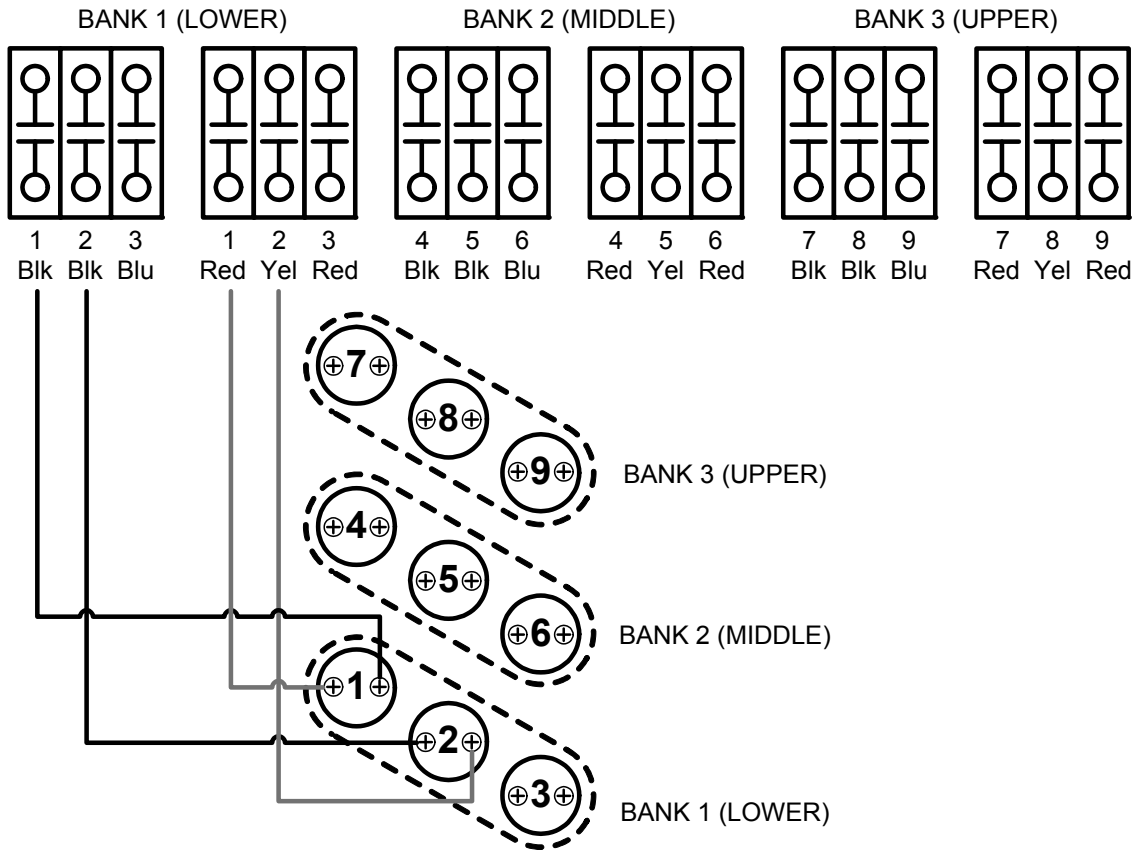

LEGEND

Servicing should only be performed by a Qualified Service Agent



Contactor Inspection

A thorough visual inspection of the contactors used on Electronic Control Models should be performed as part of any regular maintenance program and whenever the water heater is being serviced. Refer to the listed Steps and images below for this procedure.

- 1 Secure power to the water heater at the main breaker or disconnect switch.
- 2 Verify with an AC volt meter that there is not any voltage present at the Power Distribution Block, power circuit fuse block and all wiring terminals on the contactors. See Figure 2 on page 9 for the location of these components.
- 3 Remove the top cover (two small screws) from the contactor.
- 4 Check for and remove any debris from the area surrounding the switch contacts. IE: ants will occasionally infest the switch contacts and eventually cause the contactor to malfunction.
- 5 Physically test the mechanical spring action of the contactor by depressing the contactor mechanism. If the action is not smooth and/or sticks - replace the contactor.
- 6 Perform a close visual inspection of the switch contacts. The contacts are silver plated and should be smooth. Contactor chatter (see pages 6 & 34), voltage spikes, arcing, excessive current along with normal wear and tear can cause the normally smooth surface of the contacts to become burnt, pitted and damaged. In extreme cases the contacts can “weld” closed. The switch contacts are not replaceable. If the contacts show signs of excessive wear - replace the contactor.
- 7 Replace the top cover on all contactors when inspection is complete.

Top View Cover Plate On

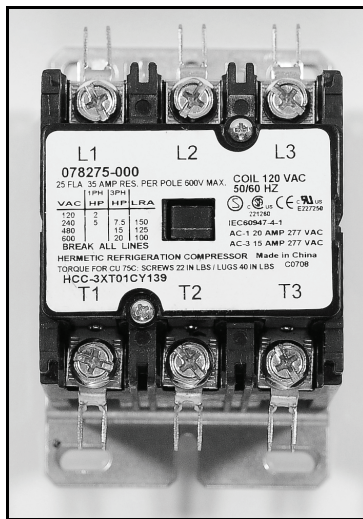

Side View Cover Plate Removed

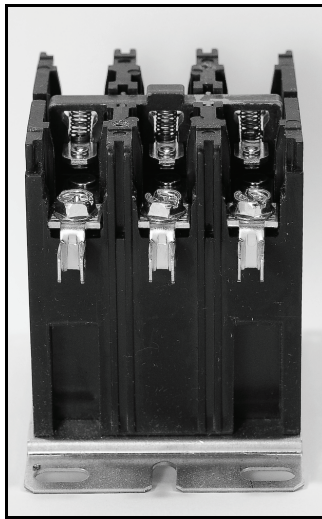

Physically Operate Mechanical Spring Action Of Contactor
Press Down Here

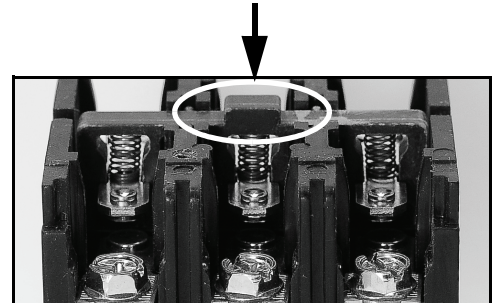

Perform Close Visual Inspection
Of Switch Contacts

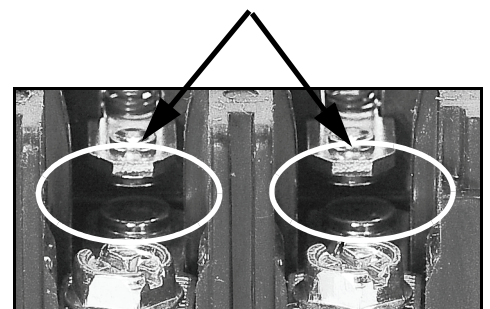

Contactors Coil Voltage - At Contactor

This test procedure will measure contactor coil voltage at the contactor.

- 1 Ensure tank temperature is less than 100°F/38°C - dump water to lower tank temperature if necessary.
- 2 Adjust the temperature settings to ensure a call heat is active for all heating elements. Raise the Operating Set Point in the Temperatures Menu to 140°F or higher. Set all Heating Element Bank Differentials in the Temperatures Menu to 2°F - see pages 52 and 53.
- 3 Using an AC volt meter; set the volt meter to an AC voltage range just above 120 VAC.
- 4 Touch the two volt meter probes to the contactor coil wiring terminals at each contactor. There should be approximately 120 volts present between the two terminals. If there is no voltage proceed to the Contactor Coil Voltage - At CCB test on page 33.

Service Warning: Be extremely careful when performing this test procedure; volt meter probes are routed between wires in tight proximity - there will be high voltage present at all terminals and wiring to the contactors.

- 5 If the measured voltage is considerably less than 120 volts and/or the contactors chatter (open and close rapidly) ensure the Control Circuit Transformer is wired correctly - see page 34.
- 6 If the measured voltage is approximately 120 volts the contactor should close it's switch contacts. If the contacts are closed the contactor coil is operating properly.
- 7 If the measured voltage is approximately 120 volts and the contactor's switch contacts do not close - the contactor is defective and must be replaced. When replacing a contactor that has failed in this way check all wiring between the contactor coil and the J4 wiring terminals on the CCB (see pages 42 and 43) for pinched or shorted wires - repair or replace damaged wiring as necessary.

Service Note: A continuity test can also be performed on contactor coils to determine if the failure is due to an open coil winding. Secure power to the water heater at the main breaker or disconnect switch, disconnect both wires to the contactor coil and check for continuity between the two terminals using an ohm meter. If a contactor has an open coil the contactor must be replaced. Check all wiring between the contactor coil and the J4 wiring terminals on the CCB (see pages 42 and 43) for pinched or shorted wires - repair or replace damaged wiring as necessary.

3 Pole Contactor Side View

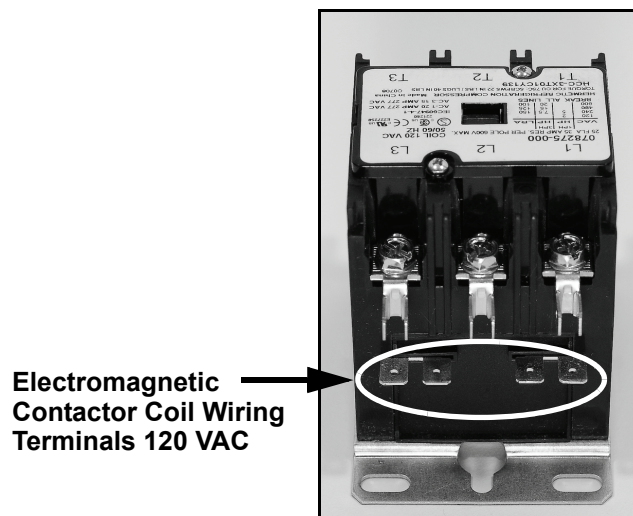

Contactor Coil Voltage - At CCB

This test procedure will measure contactor coil voltage where it originates at the J4 wiring terminals on the CCB. See page 42 for the CCB's J4 wiring terminal location.

- 1 Ensure tank temperature is less than 100°F/38°C - dump water to lower tank temperature if necessary.
- 2 Adjust the temperature settings to ensure a call heat is active for all heating elements. Raise the Operating Set Point in the Temperatures Menu to 140°F or higher. Set all Heating Element Bank Differentials in the Temperatures Menu to 2°F - see pages 52 and 53.
- 3 Using an AC volt meter; set the volt meter to an AC voltage range just above 120 VAC.
- 4 Touch one of the two volt meter probes to the ground wire connection on the water heater. Touch the other volt meter probe to the CCB's J4 OUT 1 wiring terminal. See the images below. On water heaters equipped with 6 or 9 heating elements also check between the ground connection and the CCB's J4 OUT 2 wiring terminal and on water heaters equipped with 9 elements also check between ground and the CCB's J4 OUT 3 wiring terminal. Measure and record voltage readings taken in this Step.

Service Warning: Be extremely careful when performing this test procedure - there will be high voltage present at many terminals and wiring connections in the surrounding area.

- 5 If the measured voltage(s) were approximately 120 volts the CCB circuit board is operating properly.
- 6 If the measured voltage(s) were zero or considerably less than 120 volts call the toll free Technical Support phone number listed on the back cover of this manual for further assistance.

Checking Contactor Coil Voltage at the CCB's J4 Wiring Terminals

Water Heater Ground and J4 OUT 1

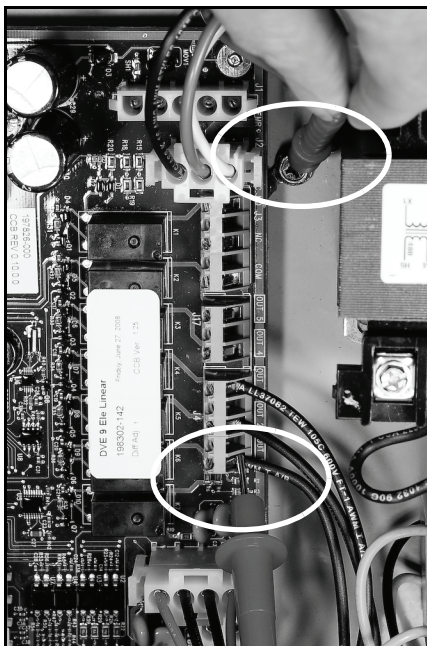

Water Heater Ground Connection

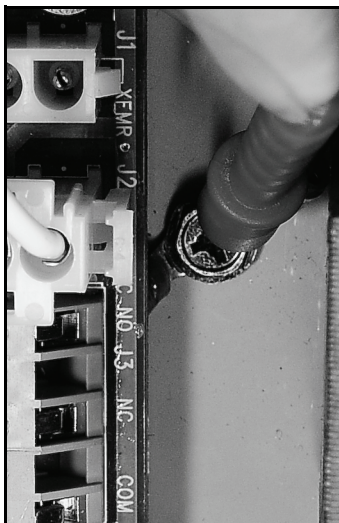

CCB's J4 OUT 1 Terminal

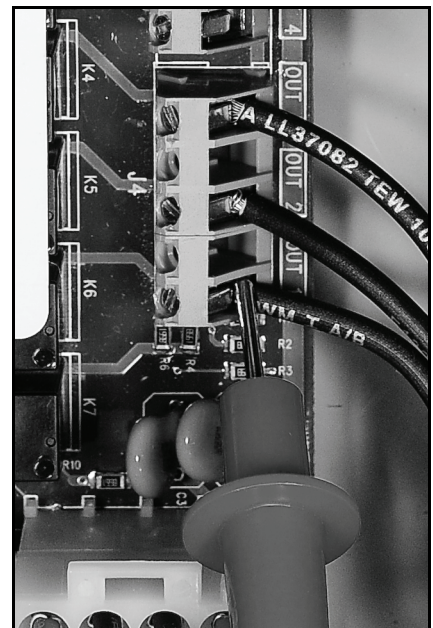

TRANSFORMERS

This section of the manual provides information on how to test and ensure the multiple tap 120 VAC Control Circuit Transformer is wired properly on Electronic Control Models. This section will also provide test procedures for the 24 VAC transformer used by the electronic control system - see Figure 2 on page 9 for location of the transformers on these models. Surface Mount Control Models are not equipped with transformers.

120 VAC Control Circuit Transformer Wiring

The 120 VAC Control Circuit transformer is a multiple or “multi” tap transformer that can accept 4 different input voltages to its primary winding. See Figure 2 on page 9 for location. This transformer outputs 120 VAC power from its secondary winding which powers the CCB circuit board and the contactor coils. The input power wiring to the primary winding of this transformer must be configured to match the power supplied to the water heater. Incorrect wiring can cause output voltage from the transformer’s secondary winding to be too low or too high. This can cause “contactor chatter” (contacts open and close rapidly) and may permanently damage the contactors and/or the CCB circuit board. The table and illustrations that follow show how to properly configure the input power wiring to the transformers primary winding.

- 1 Only one wire need be changed on the transformer to change voltage. Do not move or change the wire to the common H1 connection on the primary winding or either wire to the secondary winding X1 or X2 connections. Remove the wire from the terminal marked H2 208, H3 240, H4 277 or H5 480 and attach it to the appropriate terminal that matches the water heater’s power supply voltage.

WATER HEATER POWER SUPPLY VOLTAGE	PRIMARY WINDING CONNECTIONS
208 VAC	H1 Common & H2 (208)
240 VAC	H1 Common & H3 (240)
277 VAC	H1 Common & H4 (277)
480 VAC	H1 Common & H5 (480)

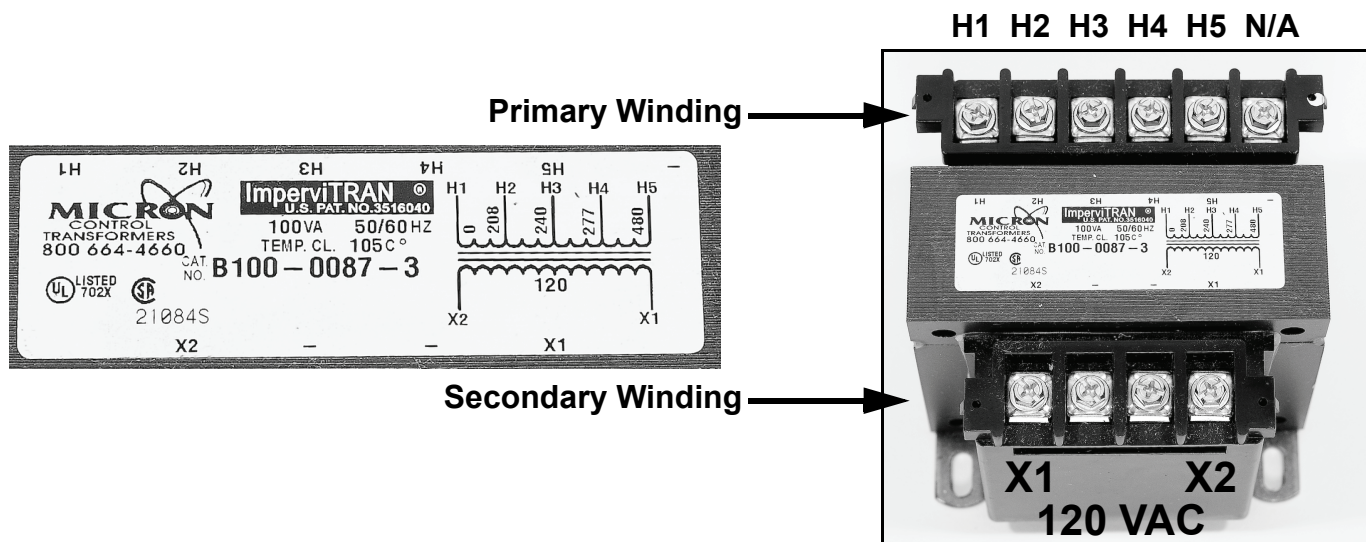

Servicing should only be performed by a Qualified Service Agent

120 VAC Control Circuit Transformer Test

- 1 Ensure the main breaker or disconnect switch is turned on.
- 2 Verify with an AC volt meter that proper voltage is present at the Power Distribution Block (see Figure 2 on page 9 and pages 12 - 14).
- 3 **Check Primary Winding Voltage:** Using an AC volt meter; set the volt meter to an AC voltage range above the expected voltage (600 VAC or higher range initially). Touch the two volt meter probes between the control circuit transformer's primary winding H1 common terminal and the other primary winding terminal with a power wired connected to it as shown in the "Primary Winding Voltage Test" image below. Voltage between these two terminals should match the water heater's power supply voltage at the Power Distribution Block. If the voltage at the primary winding terminals of the transformer matches the water heater's power supply voltage the primary winding is being powered correctly. If the voltage measured is zero volts or considerably less or more than the water heater's power supply voltage:
 - Check the wiring between the Control Circuit Transformer's primary winding and the Control Circuit Fuse Block see Figure 2 on page 9 for location - ensure wiring is correct and connections are tight and making good contact.
 - Check the wiring between the Control Circuit Fuse Block and the Power Distribution Block - ensure wiring is correct and connections are tight and making good contact.
 - Check the control circuit fuses - see Figure 2 on page 9 for location and the Fuse test procedure on page 17.
 - Verify 120 VAC Control Circuit Transformer wiring is correct - see page 34.
- 4 **Check Secondary Winding Voltage:** Using an AC volt meter; set the volt meter to an AC voltage range just above 120 VAC. Touch the two volt meter probes between the Control Circuit Transformer's secondary winding X1 and X2 terminals as shown in the "Secondary Winding Voltage Test" image below. There should be approximately 120 VAC present between these two terminals. If the voltage measured is approximately 120 VAC the Control Circuit Transformer is operating properly. If the voltage measured is zero volts or considerably less or more than 120 VAC AND all Steps above have been completed and the results were successful - replace the Control Circuit Transformer. When replacing the Control Circuit Transformer check all wiring to and from the transformer for pinched or shorted wires - repair or replace damaged wiring as necessary.

Service Note: A continuity test can also be performed on the Control Circuit Transformer primary and secondary windings to determine if either winding is an open circuit. Secure power to the water heater at the main breaker or disconnect switch, Disconnect all wiring to the transformer. Using an ohm meter check for continuity between the terminals on the primary and secondary windings checked in Steps 3 and 4 above.

Primary Winding Voltage Test

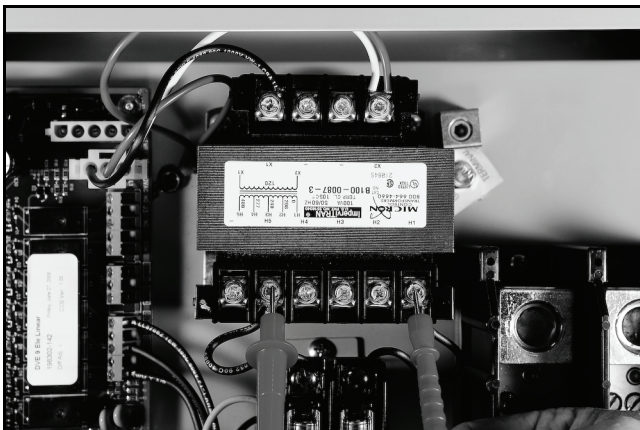

Secondary Winding Voltage Test

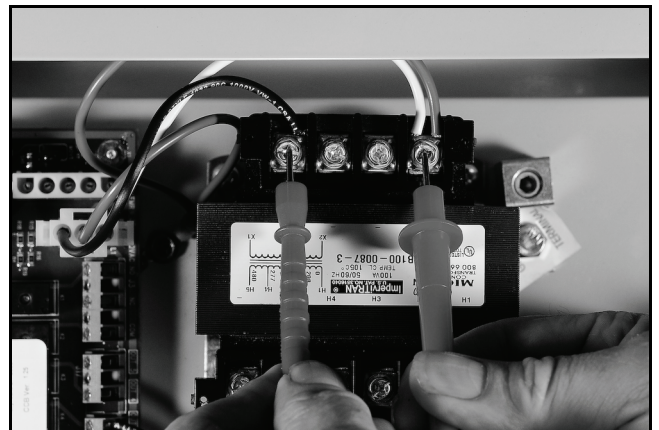

24 VAC Transformer Test

- 1 Ensure the main breaker or disconnect switch is turned on.
- 2 Verify with an AC volt meter that proper voltage is present at the Power Distribution Block (see Figure 2 on page 9 and pages 12-14).
- 3 **Check Primary Winding Voltage:** Using an AC volt meter; set the volt meter to an AC voltage range just above 120 VAC. With the J1 plug installed in the J1 socket on the CCB (page 42) insert the two volt meter probes into pins 1 & 3 of the J1 plug as shown in the “Primary Winding Voltage Test” image below. Volt meter probes may have to be pressed firmly into plug to make contact with the metal conductors inside. Voltage should be approximately 120 VAC. If the voltage measured is approximately 120 VAC the primary winding is being powered correctly. If the voltage measured is zero volts or considerably less or more than 120 VAC:
 - Check the J1 plug/socket connections on the CCB for wear or damage. Ensure they are mating properly and providing good contact - see page 42.
 - Check the 120 VAC Control Circuit Transformer to ensure it is wired correctly and outputting the correct voltage - see pages 34 & 35.
 - Ensure there is 120 VAC being supplied to the CCB - see page 46.
 - Call the toll free technical support phone number on the back cover of this manual for further assistance if all the procedures above have been performed and 120 VAC is still not present at pins 1 & 3 of the J1 socket/plug on the CCB.
- 4 **Check Secondary Winding Voltage:** Using an AC volt meter; set the volt meter to an AC voltage range just above 24 VAC. With the J1 plug installed in the J1 socket on the CCB (page 42) insert the two volt meter probes into pins 4 & 5 of the J1 plug as shown in the “Secondary Winding Voltage Test” image below. Volt meter probes may have to be pressed firmly into plug to make contact with the metal conductors inside. Voltage should be approximately 24 VAC. If the voltage measured is approximately 24 VAC the transformer is operating properly. If the voltage measured is zero volts or considerably less than 24 VAC:
 - Check the J1 plug/socket connections on the CCB for wear or damage. Ensure they are mating properly and providing good contact - see page 42.
 - Check the wiring between pins 4 & 5 of the J1 plug and the 24 VAC transformer - see Figure 2 on page 9 for transformer location. Ensure wiring is not pinched or shorted and continuous to the 24 VAC secondary winding - repair or replace damaged wiring as necessary.
 - If all the above procedures have been performed and there is still not 24 VAC present at pins 4 & 5 of the J1 plug - replace the 24 VAC transformer. When replacing the transformer check all wiring to and from the transformer for pinched or shorted wires - repair or replace damaged wiring as necessary.

Primary Winding Voltage Test

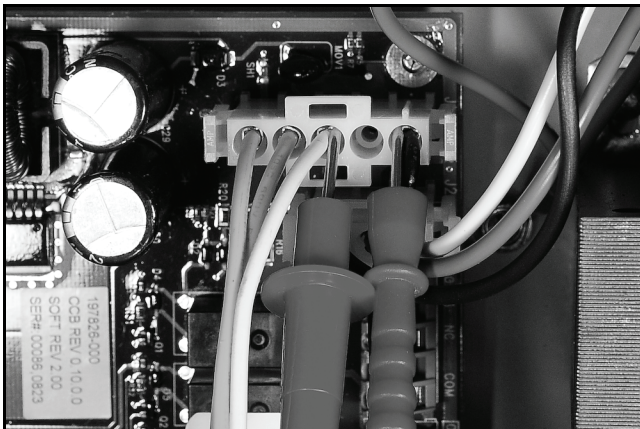

Secondary Winding Voltage Test

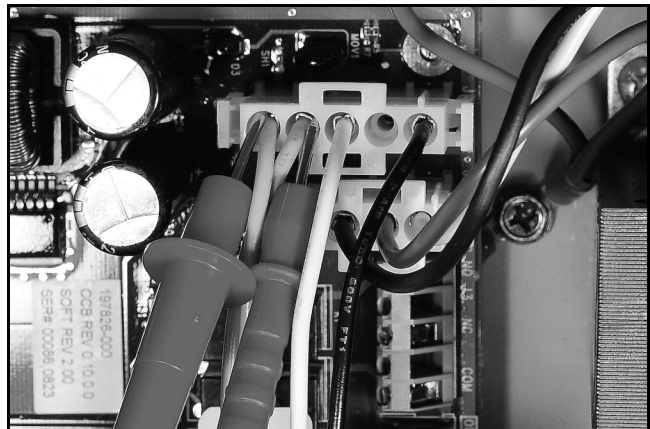

IMMERSION TEMPERATURE PROBE

This section of the manual provides information on how test the Immersion Temperature Probe on Electronic Control Models - see Figure 2 on page 9 for location. The Immersion Temperature Probe contains the ECO (energy cut out) and a Temperature Sensor. The Immersion Temperature Probe plugs into the CCB circuit board at the J5 socket. See the CCB circuit board layout and identification illustration and tables on pages 42 - 44.

Immersion Temperature Probe

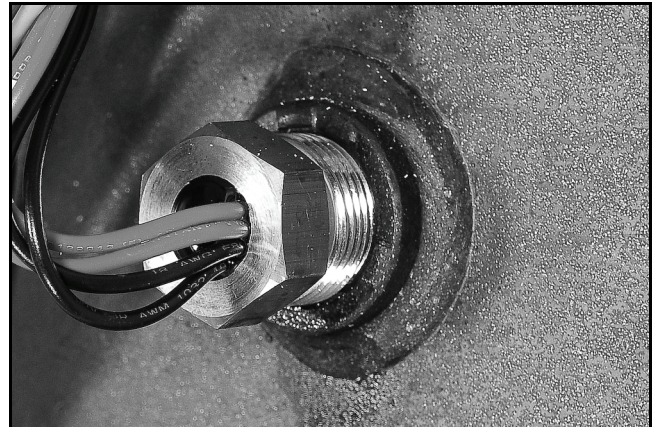

ECO High Temperature Limit Switch

The ECO (energy cut out) is a high temperature limit switch designed to protect against excessively high water temperatures inside the water heater. The ECO is a normally closed switch located inside the Immersion Temperature Probe (two red wires). The ECO temperature setting is non adjustable; the contacts open at 202°F/94°C and will close at approximately 140°F/60°C.

The control system constantly monitors the state of the ECO switch contacts. If the ECO activates (contacts open) due to abnormally high water temperature the control system will lock out and display a “Energy Cut Out (ECO)” Fault message on the UIM (page 49). Voltage to the contactor coils (page 32) and heating elements is terminated to prevent further heating operation.

Should the ECO activate, the water temperature must drop below 140°F/60°C before the control system can be reset. Once the water temperature has cooled below this point the power supply to the water heater must be turned off and on again to reset the control system.

Temperature Sensor

The temperature sensor located inside the Immersion Temperature Probe is a “thermistor” (two black wires). Thermistors are thermally sensitive resistors. As the water temperature rises the resistance (in ohms) of the sensor will decrease; as the temperature falls the resistance will increase - see the Temperature Sensor Resistance Data table on page 38. The control system interprets the changes in resistance as changes in water temperature.

The control system constantly monitors the temperature sensor (thermistor) for temperature. The control system is also programmed to declare a Fault condition if the resistance of the temperature sensor drops below 390 ohms (shorted) or above 56,000 ohms (open).

If the resistance of the temperature sensor is below 390 ohms the control system will lock out and display a “Temp Probe Short” Fault message on the UIM (page 49). If the resistance of the temperature sensor is above 56,000 ohms the control system will lock out and display a “Temp Probe Open” Fault message on the UIM. Voltage to the contactor coils (page 32) and heating elements is terminated during lock out to prevent further heating operation.

If the control system locks out the condition that caused the lock out must be corrected before the control system can be reset by cycling power off and on again.

Temperature Sensor Resistance Test

- 1 Secure power to the water heater at the main breaker or disconnect switch.
- 2 Unplug the J5 plug from the CCB circuit board - see page 42 for location.
- 3 Using an ohm meter: set the ohm meter range to a scale above 30,000 ohms initially.
- 4 Touch the ohm meter probes between the two middle pins (black wires) of the J5 plug end as shown in the image below. Compare the measured resistance value (ohms) to the values given in the resistance data table below. Temperature probes are very reliable and should only be replaced when:
 - The resistance test indicates an “open” (infinite resistance) or a “direct short” (no resistance) circuit.
 - The nature of the service problem is temperature control and the resistance readings are considerably (25% or more) different than the values in the table here at the given temperature.

Checking Temperature Sensor Resistance

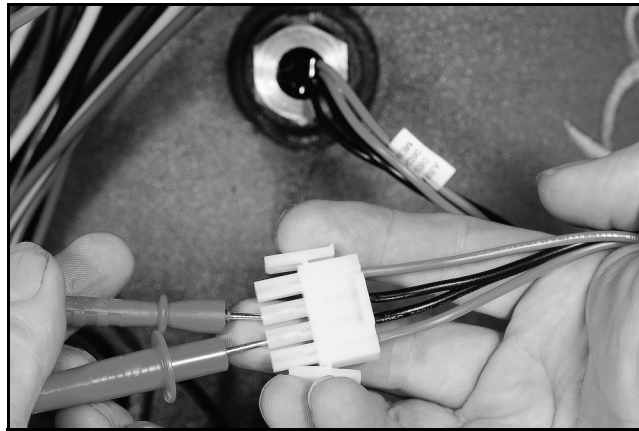

Temperature Sensor Resistance Data

WATER TEMPERATURE		RESISTANCE IN OHMS
Celsius	Fahrenheit	
3°	40°	26,435
21°	70°	11,974
38°	100°	5,862
49°	120°	3,780
55°	130°	3,066
60°	140°	2,503
71°	160°	1,698
82°	180°	1,177



Temperature Sensor DC Voltage Test

- 1 Ensure the main breaker or disconnect switch is turned on.
- 2 Verify the CCB circuit board has the correct input voltage at the J2 socket and is properly grounded - perform the “Checking Power and Ground To The CCB” tests on page 46.
- 3 Unplug the J5 plug from the CCB circuit board (note: the control system will lock out and display “Temp Probe Open” Fault message on the UIM when the J5 plug is removed - cycle power off and reinstall J5 plug when tests are complete). Using a “DC” (direct current) volt meter check for DC voltage between pins 2 & 3 of the J5 socket as shown in the “DC Voltage To Temperature Sensor” image below.
 - If the measured voltage is 5 VDC the temperature sensor is being powered correctly. If there is not 5 VDC call the toll free Technical Support phone number listed on the back cover of this manual for further assistance.

ECO Continuity Test

- 1 Secure power to the water heater at the main breaker or disconnect switch.
- 2 Unplug the J5 plug from the CCB circuit board - see page 42 for location.
- 3 Ensure tank temperature is less than 100°F/38°C - dump water to lower tank temperature if necessary.
- 4 Using an ohm meter; set the Ohm meter to it's lowest resistance range (< 200) or to an audible beep continuity test setting if so equipped.
- 5 Touch the ohm meter probes between the two outside pins (red wires) of the J5 plug end as shown in the “Checking ECO Switch Continuity” image below.
 - If the ohm meter shows continuity (closed circuit) between the two outside pins (red wires) of the J5 plug end the ECO switch has reset properly. If the control system continues to lock out displaying the “Energy Cut Out (ECO)” Fault message with continuity through the ECO present call the toll free Technical Support phone number listed on the back cover of this manual for further assistance.
 - If the ohm meter shows no continuity (open circuit) between the two outside pins (red wires) of the J5 plug end and the control system and the tank temperature is known to be at or below 100°F/38°C - replace the Immersion Temperature Probe. Secure power to the water heater and drain the water heater before replacing the probe.
 - If the control system continues to lock out displaying the “Energy Cut Out (ECO)” Fault message and the water temperature inside the water heater is becoming excessive (at or above 202°F/94°C) check contactors (pages 29 - 32) to ensure they are not stuck closed and check for voltage at all heating elements (page 24) during the standby mode. Check water system piping; ensure heat is not being added to the water inside the water heater being serviced by any other heating appliances or heat sources. If all these tests have been performed and the control system continues to lock out displaying the “Energy Cut Out (ECO)” Fault message call the toll free Technical Support phone number listed on the back cover of this manual for further assistance.

DC Voltage To Temperature Sensor

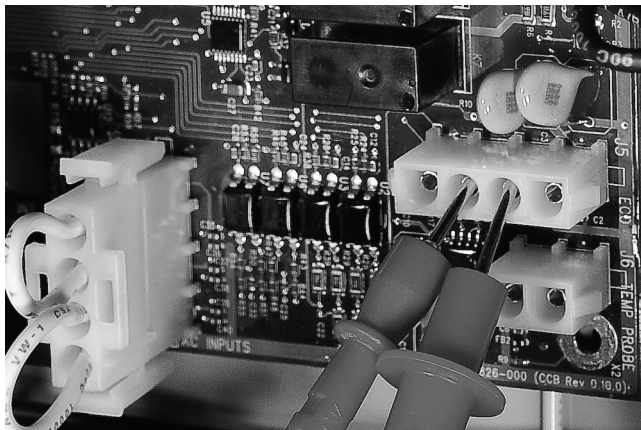

Checking ECO Switch Continuity

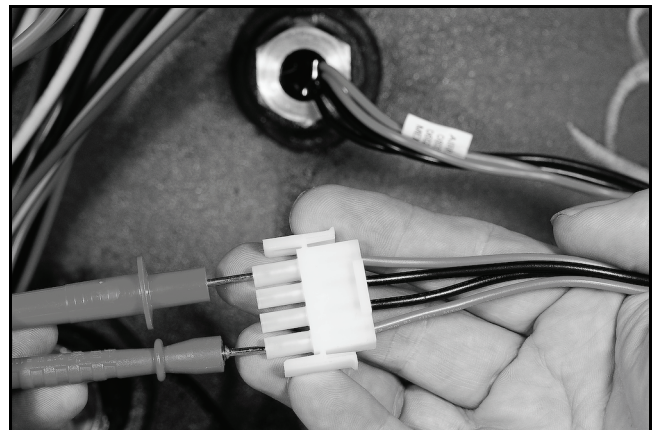

ECO Voltage Test

- 1 Ensure the main breaker or disconnect switch is turned on.
- 2 Verify the CCB has the correct input voltage at the J2 socket and is properly grounded - perform the Checking Power and Ground To The CCB tests on page 46.
- 3 Using an AC volt meter; set the volt meter to an AC voltage range just above 120 VAC.
- 4 **Check for 120 VAC to the ECO:** With the J5 plug installed in the J5 socket on the CCB (page 42) insert one of the two volt meter probes into pin 1 of J5 plug as shown in the “120 VAC To ECO” image below. Volt meter probe may have to be pressed firmly into plug to make contact with the metal conductor inside. Touch the other volt meter probe to the ground wire connection on the water heater as shown in the “Ground Connection” image below. The measured voltage should be approximately 120 VAC.
 - If the measured voltage is approximately 120 VAC proceed to Step 5.
 - If the measured voltage is zero or considerably less or more than 120 VAC and all Steps above have been performed call the toll free Technical Support phone number listed on the back cover of this manual for further assistance.
- 5 **Check for 120 VAC from the ECO:** With the J5 plug installed in the J5 socket on the CCB (page 42) insert one of the two volt meter probes into pin 1 of J5 plug as shown in the “120 VAC From ECO” image below. Volt meter probe may have to be pressed firmly into plug to make contact with the metal conductor inside. Touch the other volt meter probe to the ground wire connection on the water heater as shown in the “Ground Connection” image below. The measured voltage should be approximately 120 VAC.
 - If the measured voltage is approximately 120 VAC the ECO switch is closed, the control system should not be declaring an ECO fault condition. If the control system continues to lock out displaying the “Energy Cut Out (ECO)” Fault message in this condition call the toll free Technical Support phone number listed on the back cover of this manual for further assistance.
 - If the measured voltage is zero volts or considerably less than 120 VAC perform the “ECO Continuity Test” on page 39.

120 VAC To ECO



120 VAC From ECO

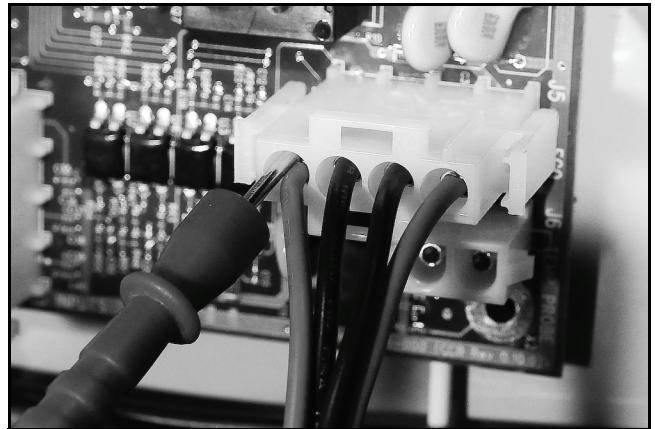

Ground Connection

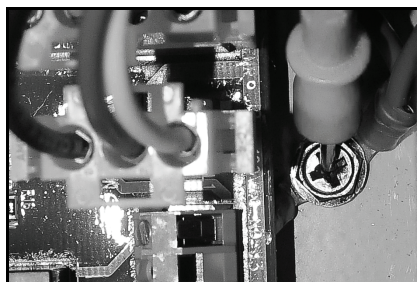

ELECTRONIC CONTROLS

This section covers the electronic control system used on Electronic Control Models - see Figure 1 on page 9. The control system includes a **CCB** (Central Control Board) and a **UIM** (User Interface Module).

The CCB constantly monitors safety controls, heating elements, water temperature and other functions of the water heater. Operational information is continuously reported to the user through text and icons on the liquid crystal display (LCD) portion of the UIM. When there are operational problems Fault and Alert messages will also be displayed. Users can navigate through multiple control system menus to view operational information and change user settings - see the Electronic Control System section beginning on page 48.

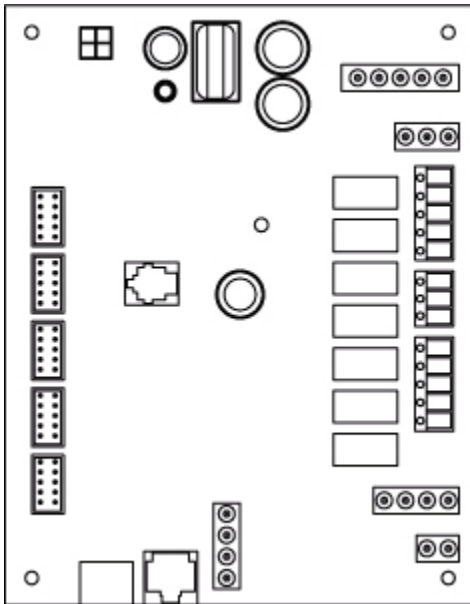

CCB (Central Control Board)

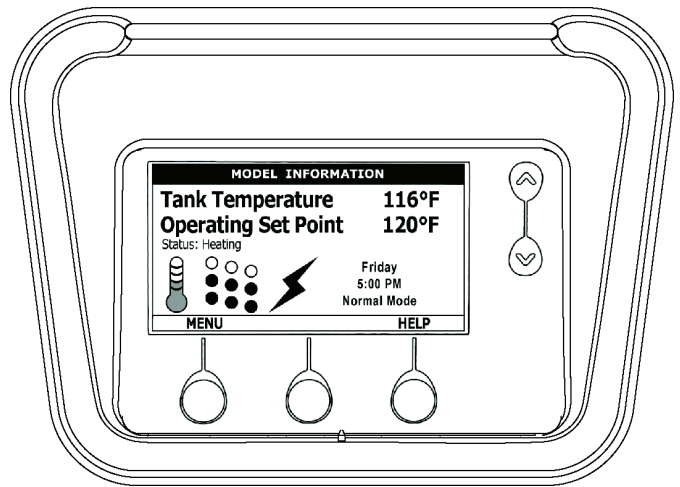

UIM (User Interface Module)

CCB - CENTRAL CONTROL BOARD

All wiring connections and sockets will be identified in the following pages. The Troubleshooting section of this manual will refer to this illustration and information.

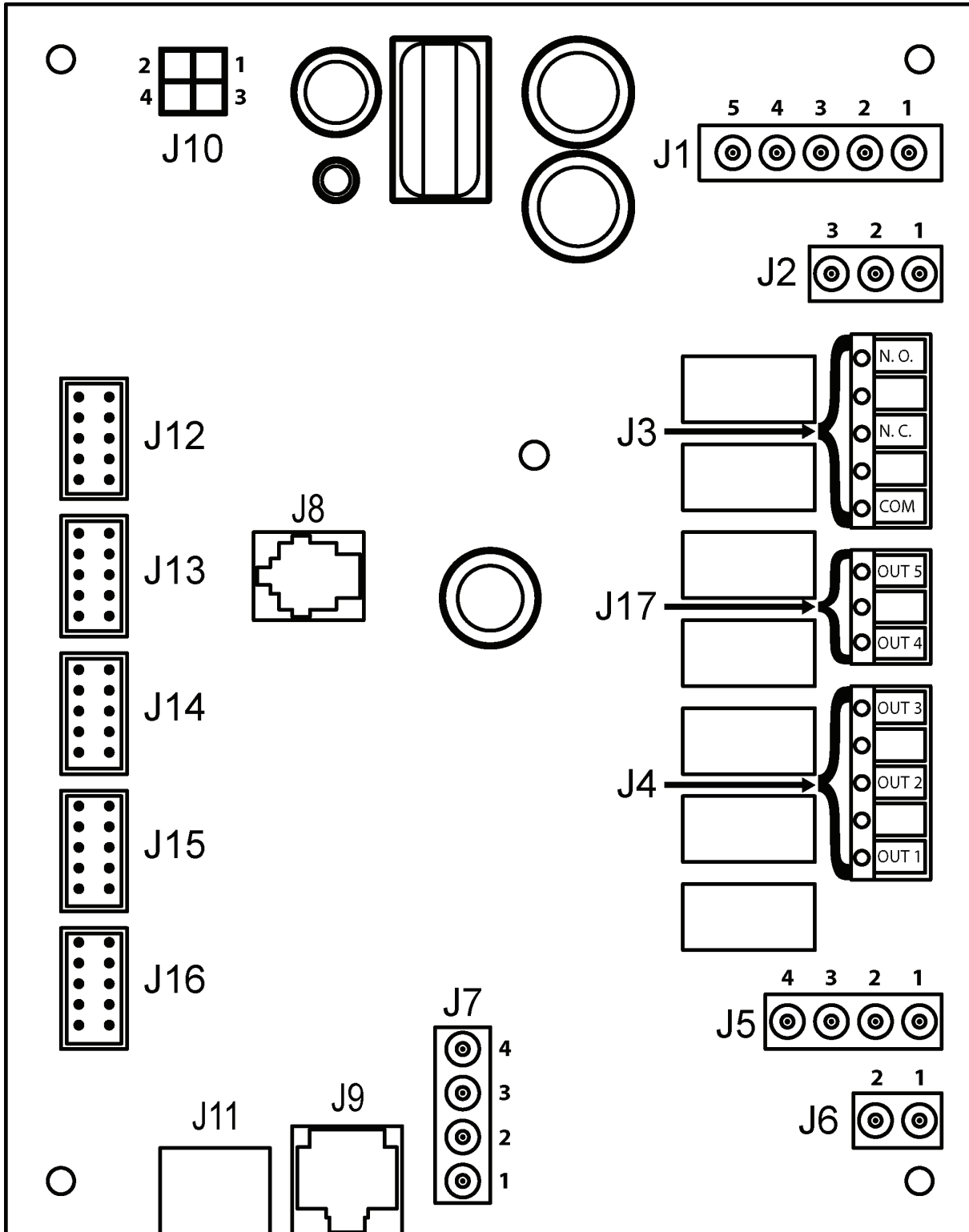

Servicing should only be performed by a Qualified Service Agent



ELECTRONIC CONTROLS

CCB Socket & Wiring Terminal Identification

Refer to the illustration on page 42 for physical location of the sockets and wiring terminals.

J1 Socket - Transformer

PIN #	DESCRIPTION
1	120 VAC hot to transformer
2	Not used
3	120 VAC neutral to transformer
4	24 VAC out from transformer
5	24 VAC out from transformer

J2 Socket - 120 VAC Power Supply

PIN #	DESCRIPTION
1	120 VAC hot
2	Earth Ground
3	120 VAC neutral

J3 Wiring Terminals - Alarm Output Relay (see page 59)

TERMINAL	DESCRIPTION
N. O.	Dry Contact Output - Normally Open Terminal Alarm Output Relay
N. C.	Dry Contact Output - Normally Closed Terminal Alarm Output Relay
COM	Dry Contact Output - Common Terminal Alarm Output Relay

J4 Wiring Terminals - Contactor Coils

TERMINAL	DESCRIPTION
OUT 1	120 VAC hot to Heating Element Bank 1 Contactor Coils
OUT 2	120 VAC hot to Heating Element Bank 2 Contactor Coils
OUT 3	120 VAC hot to Heating Element Bank 3 Contactor Coils

J5 Socket - Immersion Temperature Probe/ECO

PIN #	DESCRIPTION
1	ECO (energy cut out) 120 VAC hot out (red wire)
2	Temperature probe (thermistor) +5.0 VDC (black wire)
3	Temperature probe (thermistor) -5.0 VDC (black wire)
4	ECO (energy cut out) 120 VAC return (red wire)

J6 Socket - Not Used

ELECTRONIC CONTROLS

J7 Socket - Enable / Disable Circuits 1 & 2 (see pages 45 & 54)

PIN #	DESCRIPTION
1	Enable/Disable circuit 1
2	Enable/Disable circuit 1
3	Enable/Disable circuit 2
4	Enable/Disable circuit 2

J8 Socket - Not Used

J9 Socket - Not Used

J10 Socket - Not Used

J11 Port - Communication Port - UIM Display (user interface module)

J12 Socket - Heating Element Sensors Bank 1

J13 Socket - Heating Element Sensors Bank 2

J14 Socket - Heating Element Sensors Bank 3

J15 Socket - Not Used

J16 Socket - Not Used

J17 Wiring Terminals - Not Used



CCB Enable/Disable Circuit(s) Test

The electronic control system includes two enable/disable circuits (see page 54) for use with field installed supervisory controls such as building EMS (Energy Management System). These two circuits are located at the CCB's four pin J7 Socket. Both of these Enable/Disable circuits must be closed to enable heating operation. If either circuit is open for any reason heating operation will be disabled even though the tank temperature may be well below the Operating Set Point - see Heating Cycle Disabled on page 66.

There is a plug with two jumper wires installed from the factory in the CCB J7 socket to enable heating operation when external controls are not in use. If the plug is not present or if one of the two jumper wires fails to close either enable/disable circuit heating operation will be disabled. A simple continuity check is performed on the J7 Plug end to ensure heating should not be disabled as follows:

- 1 If either enable/disable circuit is in use (external wiring connected to J7 plug) by an external supervisory control - ensure that control's dry contacts are closed to enable heating operation. Check the supervisory control's settings/programming to ensure it is not disabling heating operation during occupied/normal demand periods.
- 2 If the J7 plug is missing or jumper wires are not installed in the J7 plug - call the toll free Technical Support phone number listed on the back cover of this manual for further assistance
- 3 If there are no external supervisory controls wired to the J7 plug: Secure power to the water heater. Unplug the J7 plug from the CCB circuit board - see page 42 for location.
- 4 Using an ohm meter; set the Ohm meter to it's lowest resistance range (< 200) or to an audible beep continuity test setting if so equipped.
- 5 Touch the ohm meter probes between pins 1 & 2 first and then between pins 3 & 4 of the J7 plug end as shown in the images below. There should be continuity present in both tests.
 - If the ohm meter shows no continuity (open circuit) between pins 1 & 2 or between pins 3 & 4 of the J7 plug end ensure the two jumper wires are properly installed in the plug end and are not broken. Ensure the J7 plug/socket connection is mating properly and providing good contact. Repair/replace damaged plug connectors/wiring as necessary.
 - If the ohm meter shows continuity (closed circuit) between pins 1 & 2 and between pins 3 & 4 of the J7 plug end and heating operation will not activate with a cold tank of water call the toll free Technical Support phone number listed on the back cover of this manual for further assistance.

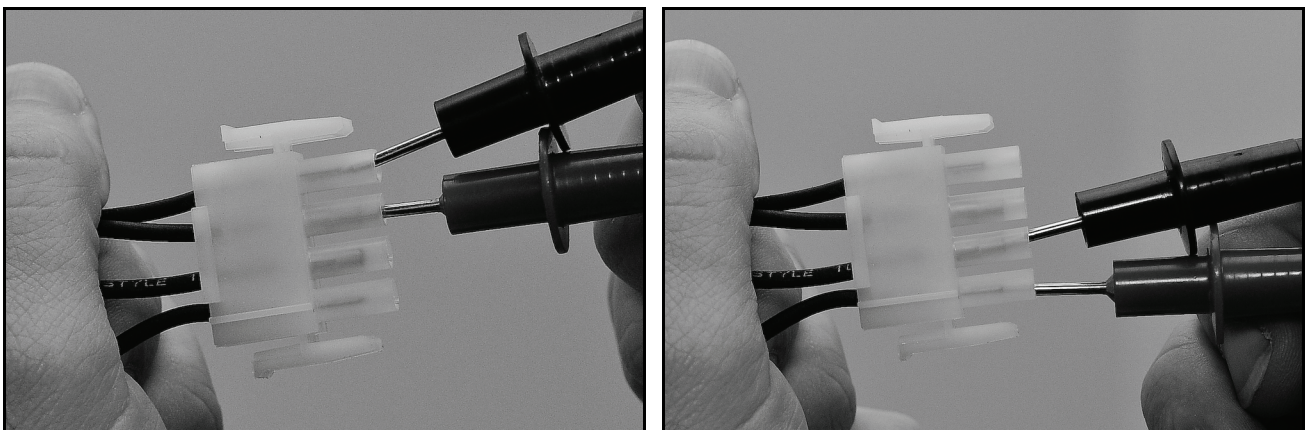

Service Note: If a supervisory control(s) is used to enable/disable heating operation, install field wiring between the J7 socket on the CCB and a set of “dry contacts” on the external control per all applicable building codes. This is a switching circuit only: DO NOT apply any external voltage or connect any load (IE: relay coil) to either circuit.

Checking Power and Ground To The CCB

The CCB circuit board is powered by the 120 VAC Control Circuit Transformer (see pages 34-35) at the J2 Socket, pins 1 & 3 (see page 42). This procedure is performed to ensure the 120 VAC power is being supplied to the CCB.

- 1 Ensure the main breaker or disconnect switch is turned on.
- 2 Verify with an AC volt meter that proper voltage is present at the Power Distribution Block (see Figure 2 on page 9 and pages 12-14).
- 3 Using an AC volt meter; set the volt meter to an AC voltage range just above 120 VAC.
- 4 **Ensure 120 VAC power is supplied to the CCB.** With the J2 plug installed in the J2 socket on the CCB (page 42) insert the two volt meter probes into pins 1 & 3 of J2 plug as shown in the “Checking for 120 VAC” image below. Volt meter probes may have to be pressed firmly into plug to make contact with the metal conductors inside. Voltage should be approximately 120 VAC.
- 5 If the measured voltage is approximately 120 VAC the CCB circuit board is receiving the correct power.
- 6 If the measured voltage is zero volts or considerably less than 120 VAC:
 - Check the 120 VAC wiring between the CCB J2 socket and the 120 VAC Control Circuit Transformer - ensure wiring is correct and connections are tight and making good contact.
 - Check the J2 plug/socket connections on the CCB for wear or damage. Ensure they are mating properly and providing good contact - see page 42.
 - Check the 120 VAC Control Circuit Transformer to ensure it is wired correctly and outputting the correct voltage - see pages 34-35.
 - Check the Control Circuit fuses - see Figure 2 on page 9 for location and the Fuse test procedure on page 17.
- 7 **Ensure earth ground is supplied to the CCB.** With the J2 plug installed in the J2 socket on the CCB (page 42) insert the two volt meter probes into pins 1 & 2 of the J2 plug as shown in the “Checking for Ground” image below. Volt meter probes may have to be pressed firmly into plug to make contact with the metal conductors inside. If the measured voltage is approximately 120 VAC the CCB is properly grounded.
- 8 If the measured voltage is zero volts or considerably less than 120 VAC:
 - Check the ground wiring between the CCB J2 socket and the water heater’s ground connection - ensure wiring is correct and connections are tight and making good contact.
 - Ensure the water heater is properly grounded.

Checking for 120 VAC

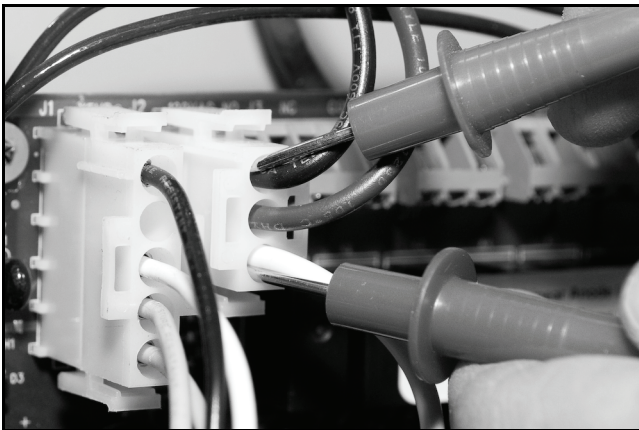

Checking for Ground

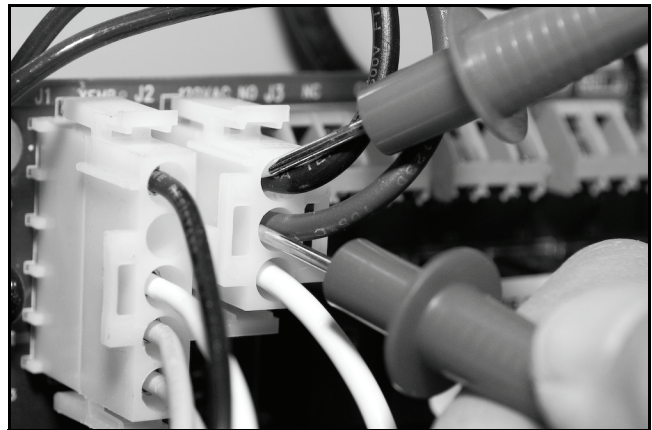

UIM - USER INTERFACE MODULE

UIM Components

The UIM's major components include a Circuit Board with LCD display and a Button Pad Overlay which contains the five user input buttons.

Service Notes - Button Pad Ribbon Cable

The Ribbon Cable that connects the Button Pad Overlay to the UIM Circuit Board must be plugged in exactly as shown in the images below; with the metal crimp connections visible on the plug end and the UIM Circuit Board back facing out. There are six pins on this Ribbon cable socket, Ensure all six pins are inserted into the Ribbon Cable plug whenever removing or installing the UIM or Button Pad Overlay.

Failure to connect this Ribbon cable exactly as shown when servicing will render the User Input Buttons inoperable. This should be checked whenever the nature of the service complaint is an inoperable or unresponsive controller or UIM.

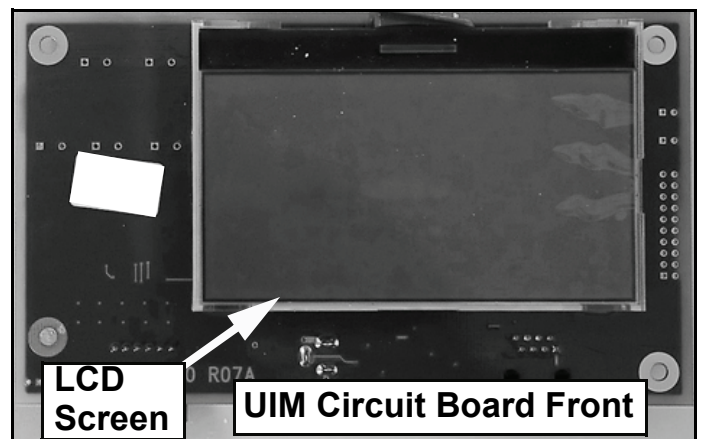
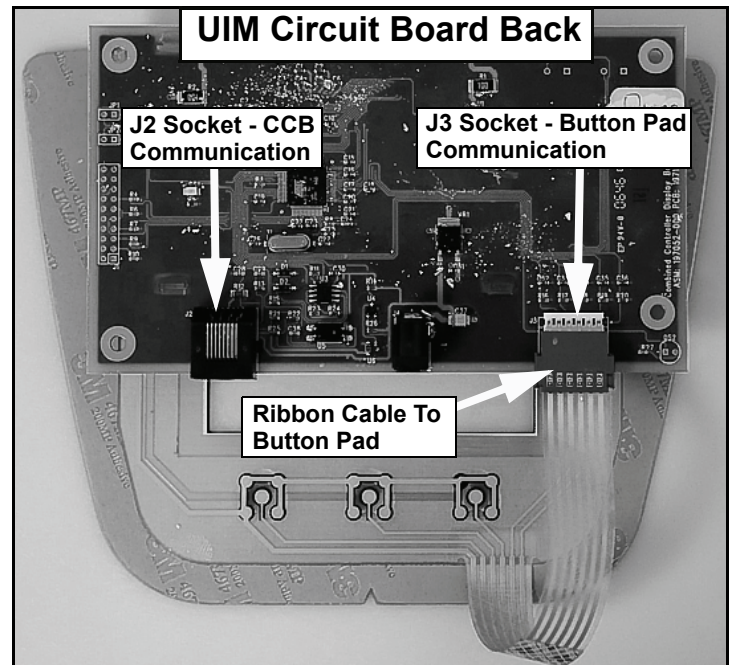
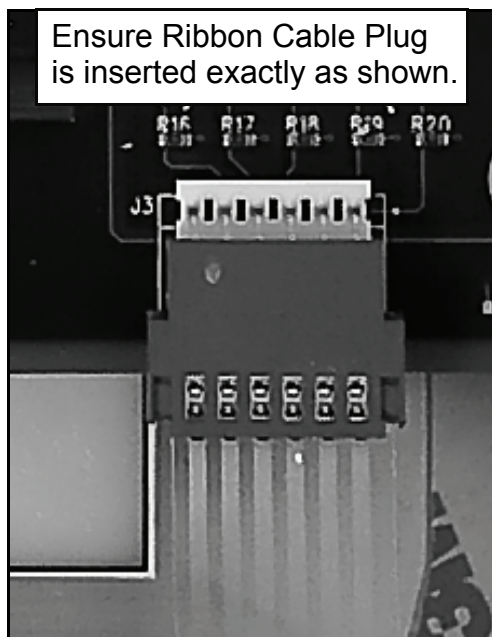
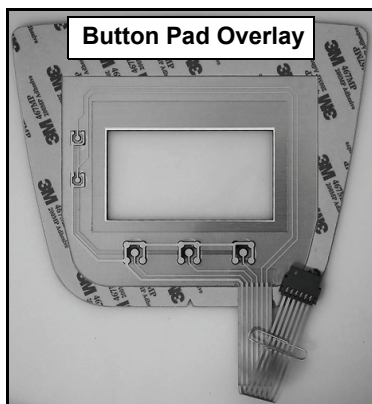

ELECTRONIC CONTROL SYSTEM

CONTROL SYSTEM FEATURES

Advanced Diagnostics: Plain English text and animated icons display detailed operational and diagnostic information. LCD screen on the front of the water heater displays the Sequence of Operation in real time. Fault or Alert messages are displayed when operational problems occur. Advanced Service menu displays a list of possible causes for current Fault and Alert conditions to aid in servicing. See the Troubleshooting section pages 65 - 69.

Economy Mode Operation: Control system automatically lowers the Operating Set Point by a programmed value during user defined time periods. Helps reduce operating costs during unoccupied or peak demand periods - see pages 55 - 58.

Linear Sequencing: First bank on is the last bank off. Banks of heating elements (3 elements per bank) are energized according to adjustable (1 to 20°) differential set points for each bank - see page 52. Helps reduce operating costs during low/moderate loads.

CONTROL SYSTEM NAVIGATION

The UIM (User Interface Module) is located on the front cabinet of the Electronic Control Model water heaters. All operational information and user settings are displayed and accessed using the UIM. The UIM includes five snap acting (momentary) user input buttons; an Up, Down and 3 Operational Buttons.

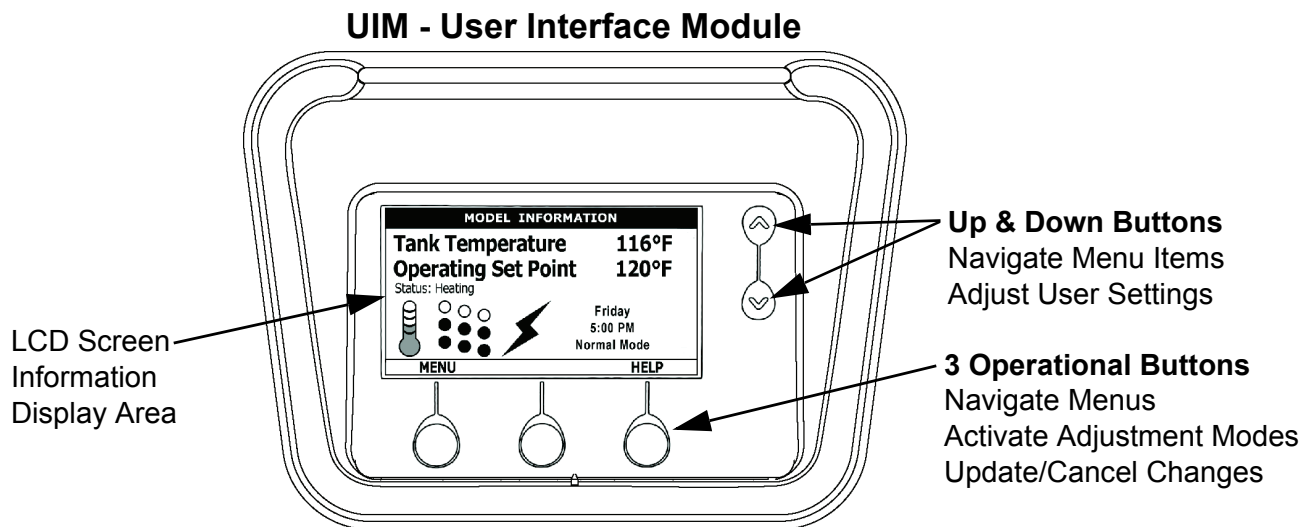

Figure 4

Up & Down Buttons

Used to navigate (up and down) and to select (highlight) menu items. Also used to adjust or change (increase/decrease, on/off, set time) various user settings.

Operational Buttons

The 3 Operational Buttons are multifunctional. Their current function is defined by the text that appears directly above each button on the LCD screen. The function will change depending on what menu is currently displayed or what menu item is selected. When no text appears on the LCD screen above an Operational Button there is no function assigned.

THE DESKTOP SCREEN

The illustration below shows the control system “Desktop Screen.” This is the default screen. If there are no active Fault or Alert conditions and no user input for approximately 10 minutes the control system will return to this screen automatically.

Model Information: Model information and menu titles are shown in the black bar at the top of the Desktop Screen.

Tank Temperature: Current water temperature as sensed from the immersion Temperature Probe.

Operating Set Point: Temperature at which the control system will maintain tank (water) temperature in the Normal Mode. This line of text will read **Economy Set Point** whenever the control system is operating in the Economy Mode. See Temperatures Menu section beginning on page 52 and Economy Mode Setup Menu section beginning on page 55.

Status: The Operating State of the control system is displayed beneath the Operating Set Point. See Table 2 on page 51.

Service Note: The Desktop Screen displays text and animated icons that convey operational information.

Review the Status Icons explanation in Table 1 on page 50 and Contactor Configurations on page 30. Learning to use this real time visual display of the operating sequence will help to quickly diagnose operational problems.

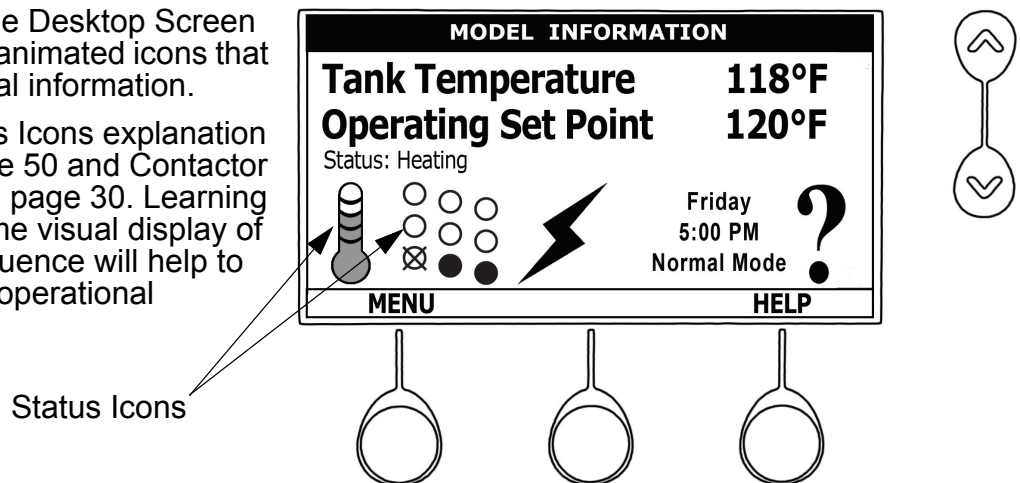

Figure 5

Day/Time/Operating Mode: The current time and day are also displayed on the Desktop Screen. “Clock Not Set” will be displayed until the time clock (page 57) has been initially set. Day and Time are adjusted in the Economy Mode Setup menu. The current Operating Mode, either Normal Mode or Economy Mode, is displayed beneath the day and time.













Menu: The left Operational Button is pressed to enter the Main Menu where all control system menus are accessed. See Table 3 on page 51 for a list of control system menus.

Help: The right Operational Button is pressed to access instructions and explanations for user settings, Operating States, Status Icons, manufacturer’s web address, technical support phone number and service agent contact information.

Discreet Menu Contact Information: From the Desktop Screen press and hold down the middle (unmarked) Operational Button for 30 seconds and then release it. This will launch a discreet menu where personalized contact information can be entered. Installing contractors and/or service agents can enter their company name and telephone number. This contact information will be displayed with all Fault and Alert messages.

ELECTRONIC CONTROL SYSTEM

Table 1 Status Icons

ICON	DESCRIPTION
	Water temperature in the tank has fallen. Shaded area of the animated thermometer icon will rise and fall in response to water temperature in the storage tank as sensed from the immersion Temperature Probe.
	Water temperature in the tank has reached the Operating Set Point. Shaded area of the animated thermometer icon will rise and fall in response to water temperature in the storage tank as sensed from the immersion Temperature Probe.
	The control is unable to initiate a heating cycle. This will happen whenever a Fault condition is detected by the control system or when either of the two Enable/Disable circuits are open circuits. For more information on Enable/Disable circuits see page 45 and the Heater Status Menu information on page 54.
	The control system is in Heating Mode and has energized the electromagnetic contactor coils for at least one bank of heating elements. This animated icon DOES NOT indicate current has been sensed from the heating elements, only that there is a call for heat present and the control system has initiated heating element operation.
	Heating elements icon for a water heater equipped with 1 Bank of heating elements. Each circle represents one heating element. Each diagonal row of 3 elements = 1 Bank of elements. Open circles represent heating elements the control system has not energized and is not sensing electrical current from.
	Heating elements icon for a water heater equipped with 2 Banks of heating elements. Each circle represents one heating element. Each diagonal row of 3 elements = 1 Bank of elements. Open circles represent heating elements the control system has not energized and is not sensing electrical current from.
	Heating elements icon for a water heater equipped with 3 Banks of heating elements. Each circle represents one heating element. Each diagonal row of 3 elements = 1 Bank of elements. Open circles represent heating elements the control system has not energized and is not sensing electrical current from.
	Heating elements icon for a water heater equipped with 3 Banks of heating elements. Each circle represents one heating element. Each diagonal row of 3 elements = 1 Bank of elements. Filled circles represent heating elements the control system has energized AND is sensing electrical current from.
	Heating elements icon for a water heater equipped with 3 Banks of heating elements. Each circle represents one heating element. Each diagonal row of 3 elements = 1 Bank of elements. Open circles with an X represent heating elements the control system has energized that it IS NOT sensing electrical current from.
	Heating elements icon for a water heater equipped with 3 Banks of heating elements. In this example 2 Banks (6 elements) have been energized and 3 elements have not. The control system is sensing electrical current from 4 heating elements. The control system is reporting that it is not sensing electrical current from 2 elements that it should be sensing current from. The control system would declare an Alert Condition in this case.
	The control has detected/declared a Fault Condition. Fault message details can be viewed in the Current Fault menu. Heating operation is discontinued (locked out) until the condition that caused the fault is corrected. Power to the water heater must be cycled off and on to reset the control system. Note; cycling power will not reset the control system if the condition that caused the fault has not been corrected.
	The control has detected/declared an Alert Condition. The water heater will continue to operate during an Alert Condition but there is an operational condition that requires the attention of a Qualified Service Agent. Alert message details can be viewed in the Current Alert menu.

Servicing should only be performed by a Qualified Service Agent

ELECTRONIC CONTROL SYSTEM

Table 2 - Operating States

STATE	DESCRIPTION
Standby	The water heater is not in an active heating cycle. This usually indicates the temperature in the tank has reached the Operating Set Point and the control system has terminated the heating cycle.
Heating	The control system is in the Heating Mode. At least one bank of heating elements has been energized.
Alert	The control system has detected/declared an Alert Condition. The controls system will continue heating operation. However, a Qualified Service Agent should be contacted to check/service the water heater.
Fault	The control system has detected/declared a Fault Condition. The control system will discontinue heating operation and “lock out.” Power to the water heater must be cycled off and on to reset the control system. Note; cycling power will not reset the control system until the condition that caused the fault has been corrected.

Table 3 - Control System Menus

MENU [†]	DESCRIPTION
Temperatures	Most commonly accessed menu. Operating Set Point, Differential settings, Tank Temperature and Tank Probe Offset are located in this menu.
Heater Status	Current Operating State/Mode (heating/standby etc) and status (open/closed - on/off - yes/no) of monitored water heater functions and components are displayed in this menu.
Economy Mode Setup	Seven day 24 hour time clock with temperature set back capability to reduce operating costs during unoccupied or reduced demand periods.
Alarm Output Setup	The control system’s CCB (Central Control Board - see page 42) features on board SPDT (single pole double throw) relay contacts for building EMS (Energy Management System) notification of operational conditions such as Fault Conditions and heating mode status. This menu features a list of user definable conditions for relay activation.
Display Settings	Temperature units (°F or °C), appearance (brightness contrast) and backlight delay user adjustable settings are located in this menu.
Heater Information	Elapsed time of operation, total heating cycle time, heating cycle count, heating element bank(s) cycle count and heating bank on time along with UIM and CCB software revisions can be viewed in this menu.
Current Fault/Alert	Displays any current Alert or Fault messages.
Fault History	Retains 9 event history of Fault/Alert messages with time stamp. The Fault History is useful when dealing with intermittent operational problems or when the customer has reset the control system prior to a service agent’s arrival.
Fault Occurrence	Total accumulated number each individual Fault condition has occurred is displayed in this menu. This running total of Fault Occurrences can be useful in determining which (if any) operational problems have been persistent.
Restore Factory Defaults	This control system feature allows the user to restore control system user settings to their factory default settings. Alarm Output Setup and Display Settings menu items ARE NOT changed when factory defaults are restored.
Help Menu	Accessible by pressing the corresponding Operational Button from most menus and screen displays. This menu provides access to instructions and explanations for user settings, Operating States, Status Icons, manufacturer’s web address, technical support phone number and service agent contact information.

†. This table shows a list of the control system menus. These menus will be explained in greater detail in the pages that follow.



TEMPERATURES MENU

Operating Set Point

User adjustable setting 90°F to 190°F range; factory default is 120°F. When the water temperature sensed by the control system from the immersion Temperature Probe reaches the Operating Set Point the control system will end the heating cycle. A call for heat will be activated again when the water temperature drops below the Operating Set Point minus the 1st Differential Setting.

Temperatures	
Operating Set Point	120°F
1st Differential	2°F
2nd Differential	2°F
3rd Differential	2°F
Tank Temperature	105°F
Tank Probe Offset	0°F
CHANGE	BACK HELP

Example: Operating Set Point is 120°F, the 1st Differential Setting is 2°F (factory default). A call for heat will be activated when the sensed water temperature drops to 118°F.

Differential Settings

Adjustable user setting(s) 1°F to 20° range; factory default is 2°F. The water heaters covered in this manual will have 3, 6 or 9 heating elements. Each group of 3 heating elements is one “Bank” of heating elements. Heating elements are energized in Banks of 3. Each Bank of heating elements will have a Differential Setting associated with it. Differential Settings are located in the Temperatures Menu.

There is a 1st Differential Setting on all models. There will be one additional Differential Setting visible/adjustable for each additional Bank of (3) heating elements.

Operating Sequence: With an Operating Set Point of 120°F and all Differential settings at 2°F the On/Off sequencing of heating element Banks would be as follows:

BANK NUMBER	DIFFERENTIAL SETTING	TURN ON TEMP	TURN OFF TEMP
Bank 1	2°F	118°F	120°F
Bank 2	2°F	116°F	118°F
Bank 3	2°F	114°F	116°F

Tank Temperature

Non adjustable information display. Current water temperature as sensed by the control system from the immersion Temperature Probe.

Tank Probe Offset

User adjustable setting -5°F to +5°F range; factory default is 0°F. If the current Tank Temperature is sensed (from the immersion Temperature Probe) at 120°F and the offset is adjusted to -5°F the control system would calibrate or “offset” the Tank Temperature to 115°F. Heating cycles would then start/stop based on the calibrated Tank Temperature.

Used to calibrate for slight differences in control system temperature sensing. This can improve the precision of temperature control in the storage tank and at points of use. This feature can also be used to compensate for building recirculation loops (hot water returning to the storage tank) that may cause the heating cycle to terminate prematurely.

Temperature Settings

The Operating Set Point and the Differential Settings are adjusted in the Temperatures Menu. The following instructions explain how to adjust these user settings and navigate the control system menus.

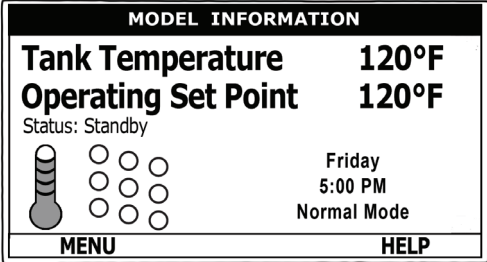
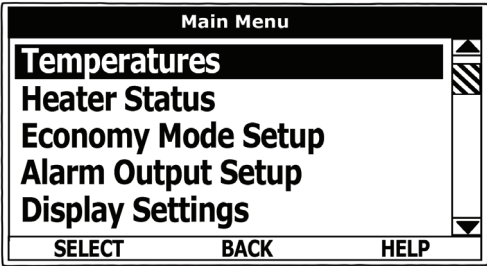
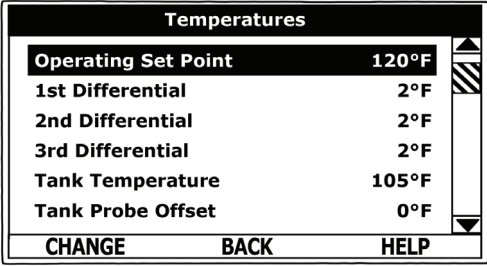
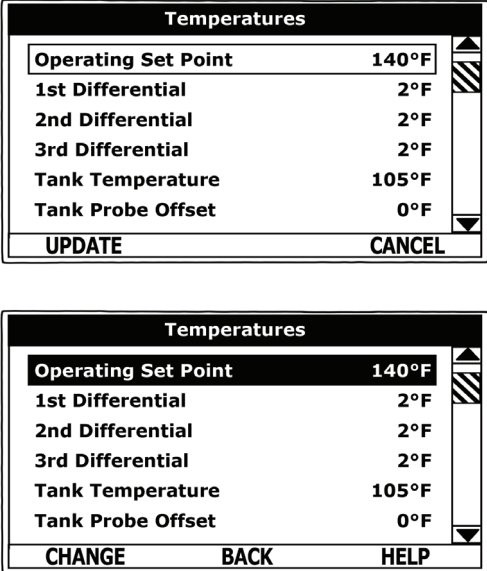
ACTION	DISPLAY
<p>From the Desktop Screen, press the Operational Button underneath “MENU” to enter the Main Menu. (see UIM Navigation on page 48)</p> <p>Notice how the text above the Operational Buttons on the display changes as you navigate through the various menus and screens.</p>	
<p>With Temperatures selected (highlight in black) in the Main Menu, press the Operational Button underneath “SELECT” to enter the Temperatures Menu.</p> <p>If Temperatures is not selected use the Up and Down buttons to select this menu item.</p>	
<p>With the Operating Set Point selected (highlight in black) in the Temperatures Menu, press the Operational Button underneath “CHANGE” to activate the adjustment mode for this menu item.</p>	
<p>Press the Up and Down buttons to adjust the Operating Set Point to the desired setting.</p> <p>Press the Operational Button underneath “UPDATE” to confirm the new setting. Press the Operational Button underneath “CANCEL” to discard the new setting and retain the previous setting.</p> <p>The new Operating Set Point value should now be displayed as the current value.</p> <p>NOTE: Use this same procedure to adjust the Differential settings and the Tank Probe Offset in the Temperatures Menu.</p> <p>This same procedure is used to change user settings in other control system menus.</p>	

HEATER STATUS MENU

This menu displays non adjustable operational information. This menu contains more information that can be displayed on one screen of the LCD display. Use the Up & Down Buttons to navigate to the bottom of this menu.

Status

Displays the current Operating State of the control system. IE: Heating, Standby, Fault etc. - see Table 2 on page 51.

Element Banks On

Displays the current number of heating element Banks the control system has energized. Each Bank of elements contains 3 heating elements.

ECO Contact

Displays the current state of the ECO high temperature limit switch contacts. The ECO switch is located inside the immersion Temperature Probe (two red wires).

Enable / Disable 1 & 2

Displays the current state, open or closed, of the two Enable/Disable circuits (J7 socket on the CCB - see page 42) provided for external supervisory controls such as building EMS (Energy Management System). Both of these Enable/Disable circuits must be closed to “enable” heating operation. If either Enable/Disable circuit is open for any reason heating operation will be “disabled.” There is a plug with two jumper wires installed from the factory in the CCB J7 socket to enable heating operation when external controls are not in use.

Service Note: If a supervisory control(s) is used to enable/disable heating operation, install field wiring between the J7 socket on the CCB and a set of “dry contacts” on the external control per all applicable building codes. This is a switching circuit only: **DO NOT** apply any external voltage or connect any load (IE: relay coil) to either circuit.

Element Bank On

Displays the on/off status of each Bank of heating elements. Yes = On, No = Off.

Alarm Condition

Displays the status of the user definable Alarm Output function (see page 59). Yes = alarm condition has been met, No = alarm condition has not been met.

Alarm Relay Output

Displays the state of the normally open contacts of the Alarm Output relay. This relay (J3 contacts on the CCB - see page x?) is used for building EMS (Energy Management System) notification of operational conditions such as Fault conditions and heating mode status.

Top Of Menu

Heater Status	
Status	Heating
Element Banks On	1
ECO Contact	Closed
Enable / Disable 1	Closed
Enable / Disable 2	Closed
Element Bank 1 On	Yes
Element Bank 2 On	No
BACK HELP	

Bottom Of Menu

Heater Status	
Enable / Disable 1	Closed
Enable / Disable 2	Closed
Element Bank 1 On	Yes
Element Bank 2 On	No
Element Bank 3 On	No
Alarm Condition	No
Alarm Relay Output	Open
BACK HELP	

ECONOMY MODE SETUP MENU

This menu contains settings used to establish an “Economy Set Point” and “Economy Mode” operating periods. This control system feature can help reduce operating costs during unoccupied, low load, or peak demand periods.

Setpoint Adjustment

Adjustable user setting (2°F to 50°F - factory default is 20°F) the control system uses to calculate the “Economy Set Point.” The Economy Set Point = normal Operating Set Point minus the programmed Setpoint Adjustment value. The Economy Set Point is the water temperature the control system maintains during programmed Economy Mode time periods. “Economy Set Point” is displayed instead of “Operating Set Point” and “Economy Mode” appears beneath the current time on the Desktop Screen during Economy Mode time periods.

Current Time

Seven Day 24 hr clock. Use this menu item to set the current time and day of the week. Current day and time are not set from the factory. “Clock Not Set” will be displayed on the Desktop until the time/day has been initially set. Note: the time will not self adjust for Daylight Savings time.

Heater In Economy Mode

Displays whether the control system is currently operating in Economy Mode or not.

Daily Operating Mode (Sun - Mon - Tue - Wed - Thu - Fri - Sat)

Seven daily sub menus are listed at the bottom of the Economy Mode Setup menu. There are 3 Operating Modes in each sub menu; “Normal Operation All Day” - “Economy Mode All Day” and “Normal Operation Between.” Only one Operating Mode can be active, the factory default is Normal Operation All Day.

Normal Operation All Day: When this operating mode is active the normal Operating Set Point (Temperatures Menu - page 52) is used for the entire day.

Economy Mode All Day: When this operating mode is active the Economy Set Point is used for the entire day. Economy Set Point = normal Operating Set Point minus the programmed Setpoint Adjustment value.

Normal Operation Between: When this operating mode is active there will also be start and stop times to program. The normal Operating Set Point is used between the programmed start and stop times and the Economy Set Point will be in effect during the rest of the day. There is one start time and one stop time event per day.

Desktop Screen During Economy Mode

Economy Mode Setup Menu

Economy Mode Settings

Setpoint Adjustment Value

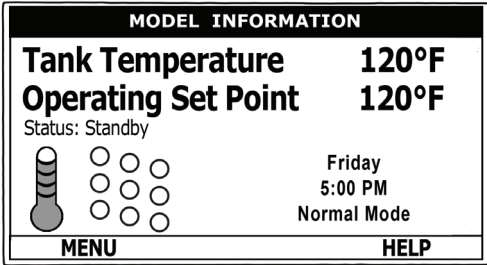
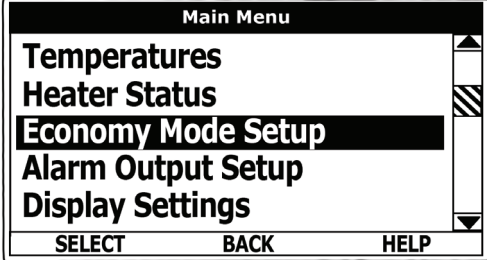
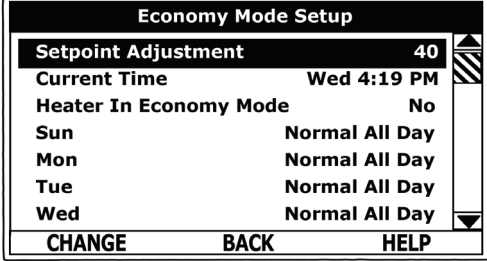
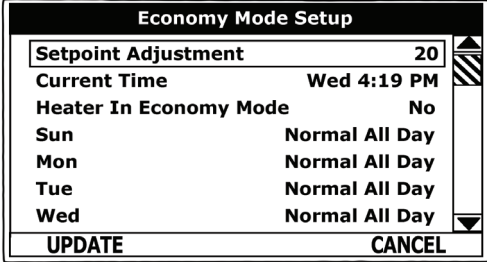
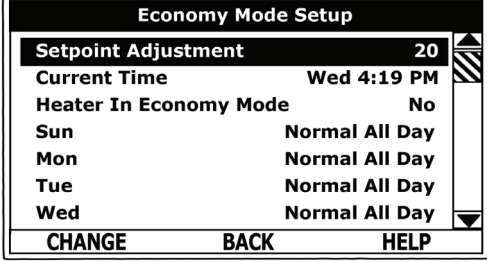
ACTION	DISPLAY
<p>From the Desktop screen, press the Operational Button underneath “MENU” to enter the Main Menu.</p> <p>(see UIM Navigation on page 48)</p> <p>Notice how the text above the Operational Buttons on the display changes as you navigate through the various menus and screens.</p>	
<p>Use the Up/Down buttons to select (highlight in black) the Economy Mode Setup menu from the Main Menu. Press the Operational Button underneath “SELECT” to enter the Economy Mode Setup menu.</p>	
<p>Use the Up/Down buttons to select (highlight in black) Setpoint Adjustment. Press the Operational Button underneath “CHANGE” to activate the adjustment mode for the Setpoint Adjustment value.</p>	
<p>Use the Up/Down buttons to change the Setpoint Adjustment to the desired value. The Setpoint Adjustment value is adjustable from 2°F to 50°F. The factory default is 20°F.</p> <p>Notice how the text above the Operational Buttons on the display changes to “UPDATE” & “CANCEL” when the adjustment mode is activated and how the current value is outlined rather than highlighted in black.</p> <p>Press the Operational Button underneath “UPDATE” to enter and confirm the new value. Pressing the Operational Button underneath “CANCEL” would discard the new value and retain the previous value.</p>	
<p>The new Setpoint Adjustment value should now be displayed as the current value.</p>	



Economy Mode Settings

Time Clock Settings

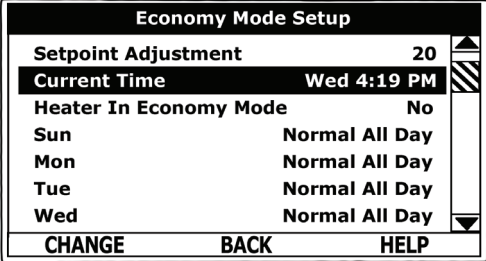
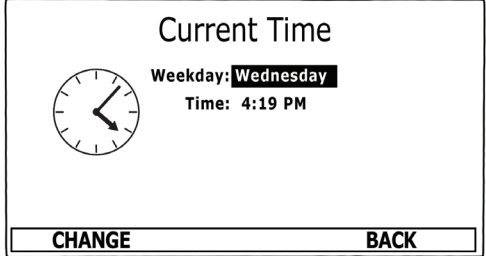
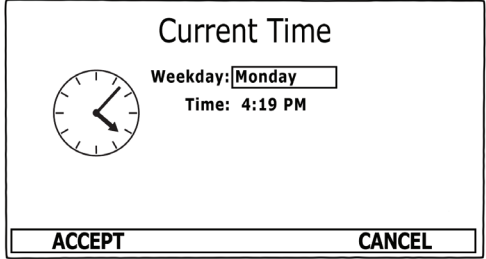
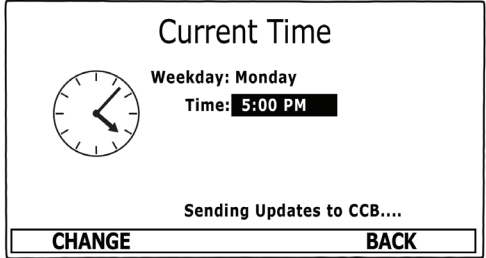
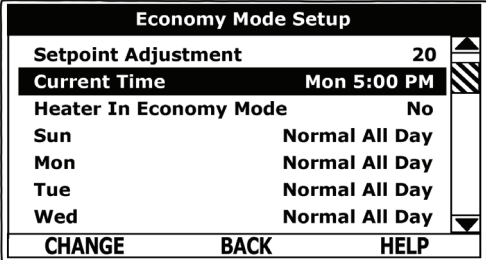
ACTION	DISPLAY
<p>From the Desktop Screen navigate to the Economy Mode Setup menu - see page 56 for instructions.</p> <p>Use the Up/Down buttons to select (highlight in black) Current Time sub menu. Press the Operational Button underneath "CHANGE" to enter the Current Time sub menu.</p>	
<p>Use the Up/Down buttons to select the "Weekday" setting.</p> <p>Press the Operational Button underneath "CHANGE" to activate the adjustment mode for this setting.</p>	
<p>Press the Up and Down buttons to adjust the Weekday setting to the current day.</p> <p>Notice how the text above the Operational Buttons on the display changes to "ACCEPT" & "CANCEL" when the adjustment mode is activated and how the current setting is outlined rather than highlighted in black.</p> <p>Press the Operational Button underneath "ACCEPT" to enter and confirm the new setting. Pressing the Operational Button underneath "CANCEL" would discard the new setting and retain the previous setting.</p>	
<p>Use the Up/Down and the CHANGE/ACCEPT Operational Buttons to individually select and change the remaining time settings (Hour, Minutes, AM/PM) to the current time in the same way as outlined above.</p> <p>When finished making changes press the Operational Button underneath "BACK" to confirm all new settings and update the control system. The display will automatically return to the Economy Mode Setup menu.</p>	
<p>The new settings should be displayed as the Current Time.</p>	



Economy Mode Settings

Daily Operating Mode Settings

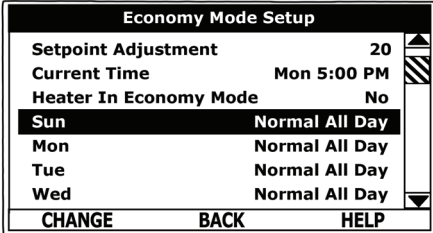
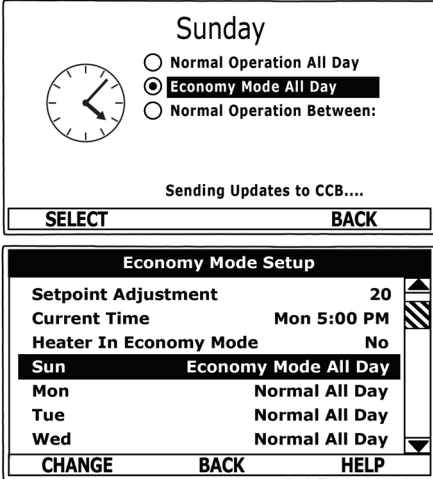
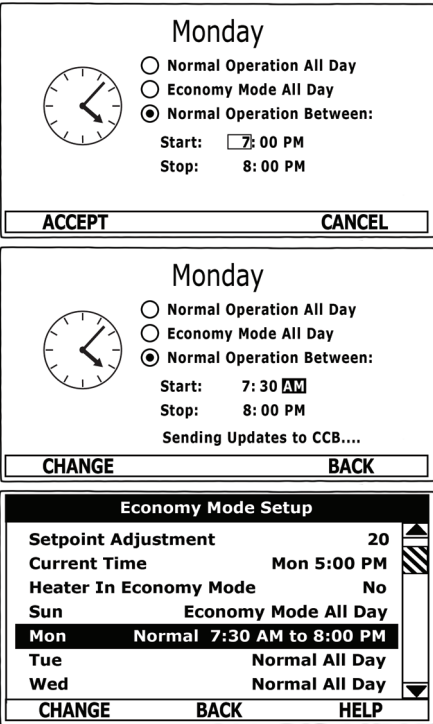
ACTION	DISPLAY
<p><u>Economy Mode All Day:</u></p> <p>From the Economy Mode Setup menu use the Up/Down buttons to select (highlight in black) the Daily sub menu for “Sun.” Press the Operational Button underneath “CHANGE” to enter this menu.</p> <p>See “Time Clock” settings on page 57 for instructions on navigating to the Economy Mode Setup menu.</p>	 <p>The screenshot shows the 'Economy Mode Setup' menu. At the top, it displays 'Setpoint Adjustment 20', 'Current Time Mon 5:00 PM', and 'Heater In Economy Mode No'. Below this is a list of days with their corresponding modes: Sun (Normal All Day), Mon (Normal All Day), Tue (Normal All Day), and Wed (Normal All Day). The 'Sun' row is highlighted in black. At the bottom, there are three buttons: 'CHANGE', 'BACK', and 'HELP'.</p>
<p>Use the Up/Down buttons to select (highlight in black) the “Economy Mode All Day” setting.</p> <p>Press the Operational Button underneath “SELECT” to change from the factory default Normal Operation All Day setting to the Economy Mode All Day setting.</p> <p>Press the Operational Button underneath “BACK” to confirm the new setting and update the control system. You will be returned to the Economy Mode Setup menu. The new setting should now be displayed for Sun.</p>	 <p>The first screenshot shows the 'Sunday' selection screen. It features a clock icon and three radio button options: 'Normal Operation All Day', 'Economy Mode All Day' (which is selected and highlighted), and 'Normal Operation Between:'. Below the options, it says 'Sending Updates to CCB...'. At the bottom are 'SELECT' and 'BACK' buttons.</p> <p>The second screenshot shows the 'Economy Mode Setup' menu after the change. The 'Sun' row now displays 'Economy Mode All Day' instead of 'Normal All Day'. The other days remain 'Normal All Day'. The 'CHANGE', 'BACK', and 'HELP' buttons are still present at the bottom.</p>
<p><u>Normal Operation Between:</u></p> <p>From the Economy Mode Setup menu Use the Up/Down and CHANGE buttons to enter the Mon sub menu as described above.</p> <p>Use the Up/Down buttons to select (highlight in black) the “Normal Operation Between” setting. Press the Operational Button underneath “SELECT” to change the operating mode for Monday to Normal Operation Between. Note that when this setting is selected Start and Stop time user settings appear on the display.</p> <p>Use the Up/Down buttons to navigate between the Start and Stop time Hour, Minutes and AM/PM settings.</p> <p>With each item selected press the Operational Button underneath “CHANGE” to activate the adjustment mode for each setting. Use the Up/Down buttons to change the value to the desired setting.</p> <p>Press the Operational Button underneath “ACCEPT” to enter the new setting or “CANCEL” to discard the new setting and retain the previous setting.</p> <p>Press the Operational Button underneath “BACK” when finished to confirm the new settings and update the control system. The display will return to the Economy Mode Setup menu with the new settings shown for Mon.</p>	 <p>The first screenshot shows the 'Monday' selection screen. It features a clock icon and three radio button options: 'Normal Operation All Day', 'Economy Mode All Day', and 'Normal Operation Between:' (which is selected). Below the options, 'Start: 7:00 PM' and 'Stop: 8:00 PM' are displayed. At the bottom are 'ACCEPT' and 'CANCEL' buttons.</p> <p>The second screenshot shows the 'Monday' selection screen after the start time has been changed. The 'Start:' field now shows '7:30 AM'. Below it, it says 'Sending Updates to CCB...'. At the bottom are 'CHANGE' and 'BACK' buttons.</p> <p>The third screenshot shows the 'Economy Mode Setup' menu with the 'Mon' row highlighted. The 'Mon' row now displays 'Normal 7:30 AM to 8:00 PM'. The other days remain 'Normal All Day'. The 'CHANGE', 'BACK', and 'HELP' buttons are still present at the bottom.</p>



ALARM OUTPUT SETUP MENU

Permits user to set the condition (from a list of options) for when the CCB's integral alarm output relay will be energized. Alarm relay connections (common, normally open, normally closed) are located on the J3 terminal strip on the CCB (see page 42). Alarm output relay contacts are capable of switching **1 amp maximum at 120 VAC**.

The alarm relay operates in the background according to the settings in this menu and is not capable of disabling water heater operation. The alarm relay is used for external notification/verification of various operational conditions such as fault conditions and heating mode status. This relay can be used with building EMS (Energy Management System) and other external supervisory controls.

Output Function

Adjustable user setting. Available options for the Alarm Output Function setting are:

Heating Mode: Used for heating mode on/off status notification.

Enable / Disable Closed: Used for notification and/or verification of the enable/disable circuits open/closed status. There are two enable/disable circuits available for external supervisory control(s) at the J7 socket on the CCB - see page 42. Enable/disable circuit(s) status can be viewed in the Heater Status Menu - see page 54.

Temp < Heater SP: Used for external notification when current tank temperature drops below Operating Set Point.

Temp < Alarm SP: Used for external notification when current tank temperature drops below programmable Alarm SP.

Fault or Alert: Used for external notification whenever a Fault or Alert condition is active.

Fault: Used for notification whenever a Fault condition is active.

Disabled: Disables the Alarm Relay Output Function.

Alarm SP

Adjustable user setting (90°F to 190°F) the control system uses for the "Temp < Alarm SP" function described above. This setting has no effect with any other Alarm Output functions.

Alarm Output Settings

Changing the user settings in this menu is done using the same methods outlined in Temperature Settings on page 53.

Service Note: Adjustable user settings in the Alarm Output Setup menu are unaffected by Restore Factory Defaults (see page 63).

Alarm Output Setup	
Output Function	Fault
Alarm SP	120°F
CHANGE BACK HELP	

Alarm Output Setup	
Output Function	Temp < Alarm SP
Alarm SP	120°F
CHANGE BACK HELP	

DISPLAY SETTINGS MENU

Permits user to set display options for viewing information on the UIM's LCD screen.

Temperature Units

Adjustable user setting that changes temperature units display to Celsius °C or Fahrenheit °F.

Backlight Delay

Adjustable user setting that determines how long the UIM's LCD backlight remains illuminated after a key has been pressed. Available settings are; Always Off, 10, 30 or 60 seconds and Always On.

Contrast

Adjustable user setting to adjust the UIM's LCD screen contrast between text and background.

Display Settings

Changing the user settings in this menu is done using the same methods outlined in Temperature Settings on page 53.

Service Note: Adjustable user settings in the Display Settings menu are unaffected by Restore Factory Defaults (see page 63).

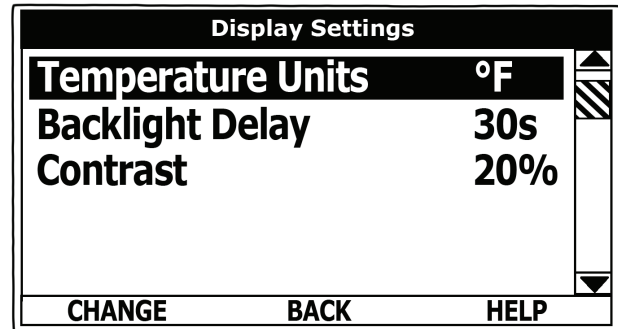

HEATER INFORMATION MENU

This menu displays non adjustable operational information.

Elapsed Time

Total accumulated time the control system (water heater) has been energized.

Total Heating Time

Total accumulated time the control system has been in the heating mode. IE: any heating elements have been energized.

Bank # Cycles

Total accumulated count of heating cycles for each Bank of heating elements.

Bank # On Time

Total accumulated heating on time for each Bank of heating elements.

CCB Version

Software version for Central Control Board.

UIM Version

Software version for User Interface Module

Top Of Menu

Heater Information	
Elapsed Time	7 days 18 hrs 35 mins
Total Heating Time	2 days 46 mins
Cycle Count	00000042
Bank 1 Cycles	00000035
Bank 1 On Time	
BACK HELP	

Bottom Of Menu

Heater Information	
Bank 2 On Time	1 day 4 hrs 44 mins
Bank 3 Cycles	00000025
Bank 3 On Time	8 hrs 30 mins
CCB Version	0.00
UIM Version	0.00
BACK HELP	

CURRENT FAULT / ALERT MENU

This menu displays non adjustable operational information. With the Fault History sub menu selected in Main Menu; press the Operational Button underneath "SELECT" to display the current Fault or Alert message. If there is not a Fault or Alert condition currently active "(none)" is displayed to the right of this menu.

FAULT HISTORY MENU

This menu displays non adjustable operational information. The control system records and stores the last 9 Fault and Alert messages in chronological order in this menu. The most recent will be at the top of the list. A time stamp is displayed below each listed Fault and Alert message showing when the Fault or Alert condition occurred.

The Fault History is useful when dealing with intermittent operational problems or when the customer has reset the control system prior to a service agent's arrival.

With a Fault or Alert item selected press the Operational Button underneath "VIEW" to display the details for the Fault or Alert message. The Fault/Alert message screen displays a brief description of the condition, contact information and access to the Advanced service information sub menu.

FAULT OCCURRENCE MENU

Total accumulated number each individual Fault condition has occurred is displayed in this menu. This running total of Fault Occurrences can be useful in determining which (if any) operational problems have been persistent.

Main Menu - Current Fault Selected

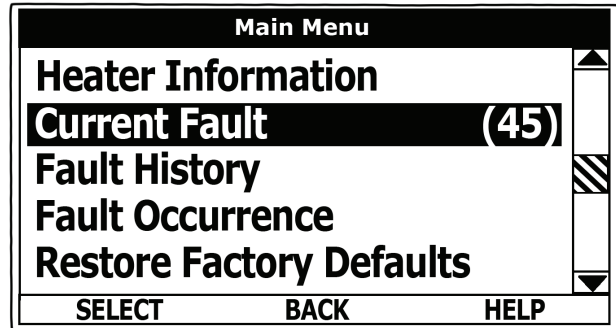

Fault History Menu

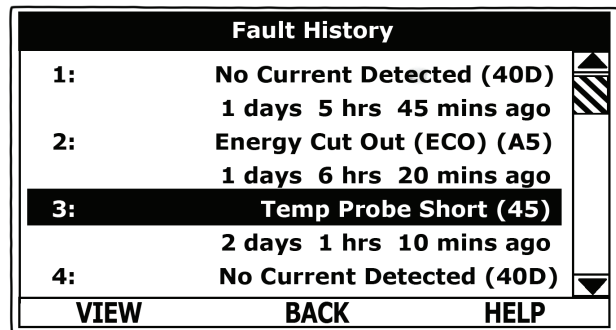

Current / History Fault Message

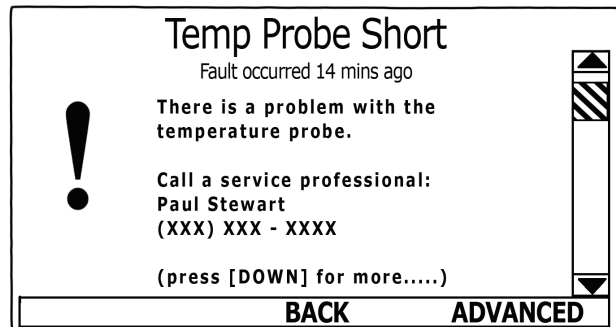

Fault Occurrence Menu

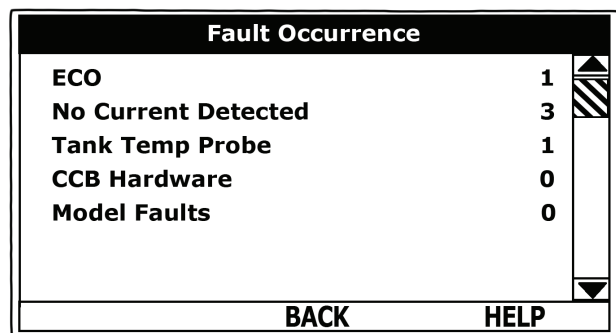

RESTORE FACTORY DEFAULTS MENU

This control system menu allows the user to restore most of the control system's user settings to their factory default settings. **User settings in the Alarm Output Setup and Display Settings menus are unaffected by executing Restore Factory Defaults.**

Restore Factory Defaults

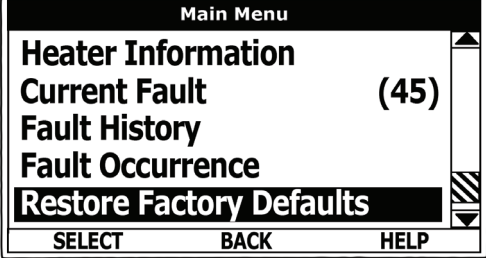
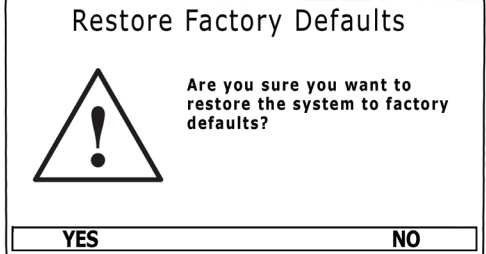
ACTION	DISPLAY
<p>From the Main Menu use the Up/Down buttons to select (highlight in black) the "Restore Factory Defaults" menu.</p> <p>Press the Operational Button underneath "SELECT." The Restore Factory Defaults menu will be displayed.</p>	
<p>From the Restore Factory Defaults menu press the Operational Button underneath "YES." The display will show text confirming the factory default settings have been restored.</p> <p>Press the Operational Button underneath "BACK" to exit the Restore Factory Defaults menu.</p>	

Factory Default User Settings

TEMPERATURES MENU	DEFAULT SETTING	ADJUSTABLE RANGE
Operating Set Point	120°F (49°C)	90°F to 190°F (32°C to 88°C)
Differential Settings	2°F (1°C)	1°F to 20°F (1°C to 11°C)
Tank Probe Offset	0°F (0°C)	-5°F to +5°F (-3°C to +3°C)
ECONOMY MODE SETUP MENU	DEFAULT SETTING	ADJUSTABLE RANGE
Setpoint Adjustment	20°F (11°C)	2°F to 50°F (1°C to 28°C)
Daily Operating Mode	Normal Operation All Day	See page 55
ALARM OUTPUT SETUP MENU	DEFAULT SETTING	ADJUSTABLE RANGE
Alarm Output Function	Disabled	See page 59
Alarm SP	100 (38°C)	90°F to 190°F (32°C to 88°C)
DISPLAY SETTINGS MENU	DEFAULT SETTING	ADJUSTABLE RANGE
Temperature Units	°Fahrenheit	°Fahrenheit or °Celsius
Backlight Delay	10 Seconds	Always off/on, 10, 30, 60 Sec
Contrast	30%	20% to 100%

Servicing should only be performed by a Qualified Service Agent

TROUBLESHOOTING

COMMON SERVICE PROBLEMS

No Hot Water

- 1 Hot water supply valve turned off.
- 2 Check power to the water heater - see pages 12 - 14.
- 3 Check thermostat/ECO controls on Surface Mount Control Models - see pages 18 & 19.
- 4 Check Operating Set Point and Differential Set Points on Electronic Control Models - see pages 52 & 53.
- 5 Check all fuses - see page 17.
- 6 Check heating elements pages 20 - 26.
- 7 Ensure both enable/disable circuits at the CCB's J7 plug/socket connection are closed circuits on Electronic Control Models. See CCB Enable/Disable Circuit(s) Test on page 45.

Not Enough Hot Water

- 1 Water heater may be undersized.
- 2 Check thermostat/ECO controls on Surface Mount Control Models - see pages 18 & 19.
- 3 Check Operating Set Point and Differential Set Points on Electronic Control Models - see pages 52 & 53.
- 4 On Electronic Control Models ensure the water heater is not in the Economy Mode during peak demand periods and ensure the time is set correctly (daylight savings etc) - see pages 55 - 58.
- 5 Ensure the power supply matches the listed voltage on the water heater rating plate - see pages 12 - 14.
- 6 Check for water supply piping leak or restriction: lime/scale - valve partially closed.
- 7 Check all fuses - see page 17.
- 8 Check heating elements pages 20 - 26.
- 9 Check Contactors on Electronic Control Models - see pages 29 - 33.
- 10 Check both enable/disable circuits at the CCB's J7 socket on Electronic Control Models. If either/both circuits are being used by a supervisory control(s) check that control's settings to ensure it is not disabling heating operation during occupied/normal demand periods. See the CCB Enable/Disable Circuit(s) Test on page 45 and Heater Status Menu information on page 54.

Water Heater Trips Breaker

- 1 Ensure the power supply breaker/fusing to the water heater meets the minimum required fuse/wire/breaker sizing. See the listed voltage and amperage on the water heater rating plate - see pages 12 - 14.
- 2 Ensure the internal power supply phase wiring is configured correctly - see pages 15 & 16.
- 3 Check for grounded heating elements - see page 26.
- 4 Check for pinched/shorted wiring - internal wiring or power supply wiring.

Contactors Chatter

Condition: contactors opening and closing rapidly.

- 1 Ensure the 120 VAC Control Circuit Transformer is properly configured to match the power supply to the water heater on Electronic Control Models - see page 34.
- 2 Ensure the power supply to the water heater matches the listed voltage on the water heater rating plate - see pages 12 - 14.
- 3 Ensure wiring connections at 120 VAC contactor coil(s) are secure and in good condition - see page 32.

SURFACE MOUNT CONTROL MODELS

See the Common Service Problems above.

ELECTRONIC CONTROL MODELS

The remainder of the Troubleshooting section covers Electronic Control Models only.

Fault Conditions

When the control system declares a Fault condition it will display a Fault message on the UIM and lock out. Voltage to the contactor coils and heating elements is terminated to prevent further heating operation.

Alert Conditions

When the control system declares an Alert condition it will continue heating but will display an Alert message on the UIM notifying the user that the water heater requires servicing.

Resetting Control System

Turn the power supply to the water heater off for approximately 20 seconds and then back on. If the operational problem that caused the control system to declare a Fault or Alert condition has not been corrected the control system will continue to display the Alert or Fault message and lock out.

CONTROL SYSTEM UNRESPONSIVE

DISPLAYED MESSAGE CONDITION/INDICATES	CHECK/REPAIR
<p style="text-align: center;">UIM Display Is Blank</p> <p>UIM is not energized - LCD display is blank.</p> <p>Possible Causes:</p> <ul style="list-style-type: none"> No power to water heater Blown control circuit transformer fuses 120 VAC power problems 24 VAC power problems Defective transformer(s) Wiring or plug/socket connection problems UIM communication cable problems <p>Important Service Reminder:</p> <p>When performing any troubleshooting steps outlined in this service manual always consider the wiring and connectors between components. Perform a close visual inspection of all wiring and connectors to a given component before replacement.</p> <p>Ensure wires were stripped before being crimped in a wire connector, ensure wires are crimped tightly in their connectors. Ensure pins inside plugs/sockets are not damaged or worn, ensure plugs/sockets are mating properly & providing good contact.</p>	<ul style="list-style-type: none"> • Check/restore power supply to the water heater at Power Distribution Block - see pages 12 - 14. • Check control circuit transformer fuses see Figure 2 page 9 and checking fuses page 17. • Check communication cable connections at UIM's J2 Socket (page 47) and the CCB's J11 Port (page 42). • Install a new communication cable between UIM's J2 Socket and the CCB's J11 Port - use standard Cat 5 network cable. • Closely inspect communication ports on CCB and UIM ensure they are mating properly and providing good contact (pages 42 & 47). • Ensure 120 VAC power/ground is supplied to CCB's J2 Socket; follow procedure on page 46. • Check J1 and J2 plug/socket connections on the CCB - ensure they are mating properly and providing good contact (page 42). • Check 24 VAC transformer: follow procedure outlined on page 36. • Call the technical support phone number on the back cover of this manual for further assistance if the problem has not been corrected after performing the procedure outlined here.



Control System Unresponsive (cont)

DISPLAYED MESSAGE CONDITION/INDICATES	CHECK/REPAIR
<p style="text-align: center;">UIM is Inoperable</p> <p>UIM does not respond to any user input using the operational and/or Up and Down buttons.</p>	<ul style="list-style-type: none"> • Ensure Ribbon Cable from the Button overlay is inserted correctly in UIM J3 Socket (page 47). • Call the technical support phone number on the back cover of this manual for further assistance if the problem has not been corrected after performing the procedure outlined here.
<p style="text-align: center;">Heating Cycle Disabled</p> <p>Control System not activating call for heat with cold tank of water. Thermometer Icon on Desktop Screen appears with diagonal line as shown here.</p> <p>Possible Causes: Fault condition active Enable/disable circuit(s) open</p> <div style="text-align: center;">  </div>	<ul style="list-style-type: none"> • Check for and correct any active Fault condition - see Current Fault Menu page 62. • Check enable/disable circuits - ensure both circuits are closed; follow procedure outlined on page 45. • Call the technical support phone number on the back cover of this manual for further assistance if the problem has not been corrected after performing the procedure outlined here.



FAULT AND ALERT MESSAGES

Troubleshooting procedures for the most common Fault and Alert messages are covered in this section. In the tables that follow the first column shows the Fault or Alert message as displayed by the UIM along with an explanation. The second column details things to check or repair and references test procedures detailed in the Operation and Service section (pages 10 - 47) of this manual.

DISPLAYED MESSAGE CONDITION/INDICATES	CHECK/REPAIR
<p style="text-align: center;">“No Current Detected” (Alert Condition)</p> <p>The control system has not detected current in one or more heating element circuits when expected.</p> <p>Possible Causes:</p> <p>Power supply problem (dead leg on 3 phase supply) Blown power circuit fuses Defective heating element(s) Defective contactor(s) Plug/socket connection problems Defective Element Sensor Wiring connection problems</p> <div data-bbox="277 1045 841 1350" style="border: 1px solid black; padding: 10px; margin: 10px 0;"> <p style="text-align: center;">Alert: No Current Detected Alert occurred 14 mins ago</p> <div style="display: flex; align-items: center;"> <p>No current detected in one or heating circuit(s).</p> </div> <p style="font-size: 0.8em;">Note this is an alert. The unit will continue to heat water in (press [DOWN] for more.....)</p> <div style="display: flex; justify-content: space-between; border-top: 1px solid black; padding-top: 5px;"> BACK ADVANCED </div> </div>	<ul style="list-style-type: none"> • Ensure the power supply to the water heater matches the listed voltage on the water heater rating plate. Ensure there is not a dead leg of power on 3Ø models - see pages 12 - 14. • Check power circuit fuses - see page 17. • Check heating elements see pages 20 - 26. • Check contactors - see pages 29 - 33. • Check power circuit wiring to heating elements from Power Distribution Block, to fuse blocks, to contactors, to heating elements - see wiring diagram on water heater and Contactor Configuration illustration on page 30. Correct any mis wiring. Repair or replace damaged wiring as necessary. • Check the Element Sensor J12, J13, J14 plug/socket connections at the CCB for wear or damage - see page 28. Ensure they are mating properly and providing good contact. See CCB illustration and socket identification on pages 42 - 44 for location. • Check Element Sensors - see pages 27 & 28. Replace any Element Sensors determined to be defective. • Call the toll free technical support phone number on the back cover of this manual for further assistance if the problem has not been corrected after performing the procedures outlined here.

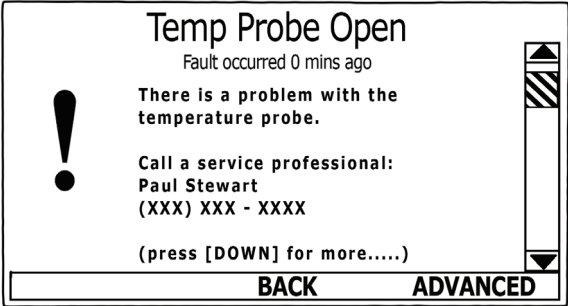
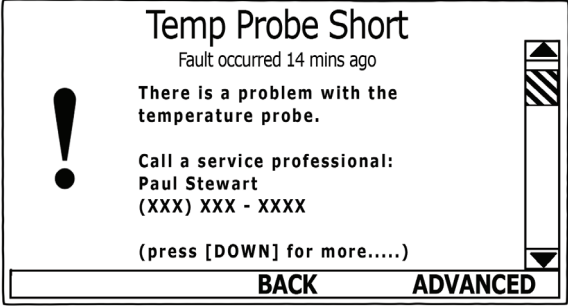

Fault & Alert Messages

DISPLAYED MESSAGE CONDITION/INDICATES	CHECK/REPAIR
<p style="text-align: center;">“Temp Probe Open” (Fault Condition)</p> <p>The control system has detected an open circuit in the temperature sensor. The control system will declare this fault condition if it senses a resistance above 56,000 ohms from the temperature sensor.</p> <p>Possible Causes: Plug/socket connection problems Wiring connection problems Defective Immersion Temperature Probe</p> 	<ul style="list-style-type: none"> • Check the J5 plug/socket connections at the CCB ensure they are mating properly and providing good contact. Check the pins inside the J5 plug/socket for wear or damage. See CCB illustration and socket identification on pages 42 - 44. Replace damaged plug connectors/wiring harness as necessary. • Check for pinched or broken wiring between the Immersion Temperature Probe and the J5 plug/socket connection on the CCB - repair or replace damaged wiring as necessary. See CCB illustration and socket identification on pages 42 - 44. • Check the resistance of the temperature sensor inside the Immersion Temperature Probe - see pages 37 - 39. Replace the Immersion Temperature Probe if measured resistance is above 56,000 ohms. • Call the toll free technical support phone number on the back cover of this manual for further assistance if the problem has not been corrected after performing the procedures outlined here.
<p style="text-align: center;">“Temp Probe Short” (Fault Condition)</p> <p>The control system has detected a shorted circuit in the temperature sensor. The control system will declare this fault condition if it senses a resistance below 390 ohms from the temperature sensor.</p> <p>Possible Causes: Shorted wiring Defective Immersion Temperature Probe</p> 	<ul style="list-style-type: none"> • Check for pinched or shorted wires between the J5 plug/socket connection on the CCB and the Immersion Temperature Probe - repair or replace damaged wiring as necessary. See CCB illustration and socket identification on pages 42 - 44. • Check the resistance of the temperature sensor inside the Immersion Temperature Probe - see pages 37 - 39. Replace the Immersion Temperature Probe if measured resistance is below 390 ohms. • Call the toll free technical support phone number on the back cover of this manual for further assistance if the problem has not been corrected after performing the procedures outlined here.



Fault & Alert Messages

DISPLAYED MESSAGE CONDITION/INDICATES	CHECK/REPAIR
<p style="text-align: center;">“Energy Cut Out (ECO)” (Fault Condition)</p> <p>The control system has detected excessive water temperature inside the water heater. The ECO high temperature limit switch activates at 202°F/94°C. See ECO High Temperature Limit Switch description on page 37.</p> <p>Possible Causes: Plug/socket connection problems Wiring connection problems Contactor(s) stuck closed Contactor coils being energized in standby mode Defective Immersion Temperature Probe Water piping problems</p> <div data-bbox="277 898 841 1203" style="border: 1px solid black; padding: 10px; margin: 10px 0;"> <p style="text-align: center;">Energy Cut Out (ECO) Fault occurred 0 mins ago</p> <div style="display: flex; align-items: center;"> <p>Tank temperature is excessive. The water heater has been disabled.</p> </div> <p>Call a service professional Paul Stewart (XXX) XXX-XXXX</p> <p>(press [DOWN] for more.....)</p> <div style="display: flex; justify-content: space-between; border-top: 1px solid black; padding-top: 5px;"> BACK ADVANCED </div> </div>	<ul style="list-style-type: none"> • Check the J5 plug/socket connections at the CCB ensure they are mating properly and providing good contact. Check the pins inside the J5 plug/socket for wear or damage. See CCB illustration and socket identification on pages 42 - 44. Replace damaged plug connectors/wiring harness as necessary. • Check for pinched or broken wiring between the Immersion Temperature Probe and the J5 plug/socket connection on the CCB - repair or replace damaged wiring as necessary. See CCB illustration and socket identification on pages 42 - 44. • Check ECO continuity and for 120 VAC to and from the ECO - see pages 37 - 40. Replace Immersion Temperature Probe if ECO switch contacts remain open at normal operating temperatures. • Ensure the contactors are not stuck closed - see page 31. • Ensure the contactor coils are not being energized during standby mode - see pages 32 & 33. • Check water system piping; ensure heat is not being added to the water inside the water heater being serviced by any other heating appliances or heat sources. • Call the toll free technical support phone number on the back cover of this manual for further assistance if the problem has not been corrected after performing the procedures outlined here.



NOTES

NOTES

NOTES



Technical Support and Parts: 800-456-9805
www.americanwaterheater.com