

# Bissell®



## REVOLUTION® HYDROSTEAM™ UPRIGHT CARPET CLEANER WITH STEAM MODELS 3670F, 3672H (PROFESSIONAL)

What's in the Box?.....	3	Cleaning with the Hose and Tools.....	7
Assembly .....	3	After-Cleaning Care .....	8
Controls and Cleaning Modes.....	3	Replacing Belts and Brush Rolls.....	11
Filling the Clean Water Tank.....	4	Troubleshooting.....	11
Three Modes of Cleaning.....	5	Limited Warranty .....	12



### Product Overview

1. Handle with Fingertip Controls
2. Clean Water Tank Handle
3. Clean Water Tank
4. Dirty Water Tank Handle
5. Machine Handle
6. Dirty Water Tank
7. Mode Indicator Lights
8. Accessory Door
9. HydroSteam Bar
10. EdgeSweep® Brushes
11. Formula & Steam Spray Trigger
12. Quick Release™ Cord Wrap
13. Recline Pedal

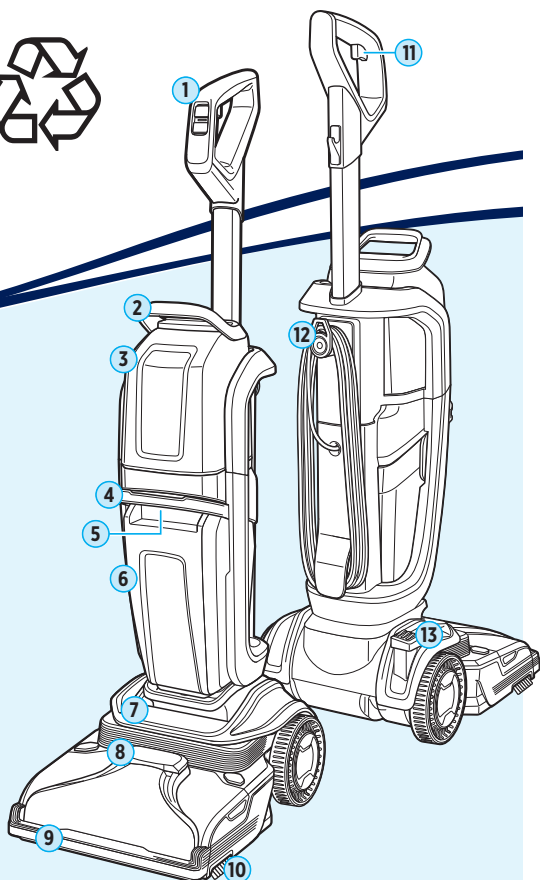

# IMPORTANT SAFETY INSTRUCTIONS



## READ ALL INSTRUCTIONS BEFORE USING YOUR APPLIANCE.

When using an electrical appliance, basic precautions should be observed, including the following:

## WARNING

### TO REDUCE THE RISK OF FIRE, ELECTRIC SHOCK OR INJURY:

- This appliance can be used by children aged from 8 years and above and persons with reduced physical, sensory or mental capabilities or lack of experience and knowledge if they have been given supervision or instruction concerning use of the appliance in a safe way and understand the hazards involved.
- Children being supervised not to play with the appliance.
- Cleaning and user maintenance shall not be made by children without supervision.
- Keep the appliance out of reach of children when it is energized or cooling down.
- Do not leave appliance when it is plugged in. Unplug from outlet when not in use and before servicing.
- Use indoors only.
- Do not immerse. Use only on carpet moistened by cleaning process.
- Always install float before any wet pick-up operation.
- Use only cleaning products intended for use with this appliance to prevent internal component damage. See the Cleaning Formulas section of this guide.
- Do not allow to be used as a toy. Close attention is necessary when used by or near children.
- Do not use for any purpose other than described in this user guide. Use only manufacturer's recommended attachments.
- Do not use with damaged cord or plug. If appliance is not working as it should, has been dropped, damaged, left outdoors, or dropped into water; do not attempt to operate it and have it repaired at an authorized service center.
- Do not pull or carry by cord, use cord as a handle, close door on cord, or pull cord around sharp edges or corners. Do not run appliance over cord. Keep cord away from heated surfaces.
- Do not unplug by pulling on cord. To unplug, grasp the plug, not the cord.
- Do not handle plug or appliance with wet hands.
- Do not put any object into openings. Do not use with any opening

blocked; keep openings free of dust, lint, hair, and anything that may reduce air flow.

- Keep hair, loose clothing, fingers, and all parts of body away from openings and moving parts of the appliance and its accessories.
- Turn OFF all controls before plugging or unplugging appliance.
- Use extra care when cleaning on stairs.
- Do not use to pick up flammable or combustible materials (lighter fluid, gasoline, kerosene, etc.) or use in areas where they may be present.
- Do not pick up anything that is burning or smoking, such as cigarettes, matches or hot ashes.
- Unplug from outlet before filling, rinsing or cleaning.
- Do not turn over the steam-cleaning nozzle, or touch the surface of the nozzle when using the steam-cleaner.
- Do not apply steam directly to any person or animal.
- Do not touch the steam cleaning nozzle or adjacent surfaces when steam-cleaning or when the nozzle is heated.
- Risk of injury from moving parts. "Brushes" may start unexpectedly. Unplug before cleaning or servicing.
- Do not turn your appliance ON until you are familiar with all instructions and operating procedures.
- Keep appliance on a level surface.
- Do not leave steam cleaner unattended.
- Liquid must not be directed towards equipment containing electrical components.
- Do not use appliance in an enclosed space filled with vapors given off by oil-based paint, paint thinner, some moth-proofing substances, flammable dust, or other explosive or toxic vapors.
- Do not use to pick up toxic material (chlorine bleach, ammonia, drain cleaner, etc.)
- Do not pick up hard or sharp objects such as glass, nails, screws, coins, etc.
- Plastic film can be dangerous. To avoid danger of suffocation, keep away from children.
- Connect to a properly grounded outlet only. See grounding instructions.
- Do not modify the three-prong grounded plug.
- Unplug before connecting Turbo Brush.
- Do not carry the appliance while in use.

## WARNING

Improper connection of the equipment-grounding conductor can result in a risk of electrical shock. Check with a qualified electrician or service person if you aren't sure if the outlet is properly grounded. DO NOT MODIFY THE PLUG. If it will not fit the outlet, have a proper outlet installed by a qualified electrician. This appliance is designed for use on a nominal 120-volt circuit, and has a grounding attachment plug that looks like the plug in the illustration. Make certain that the appliance is connected to an outlet having the same configuration as the plug. No plug adapter should be used with this appliance.

### GROUNDING INSTRUCTIONS

This appliance must be connected to a grounded electrical wiring system. If it should malfunction or break down, grounding provides a safe path of least resistance for electrical current, reducing the risk of electrical shock. The cord for this appliance has an equipment-grounding conductor and a grounding plug. It must only be plugged into an outlet that is properly installed and grounded in accordance with all local codes and ordinances.

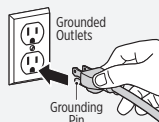

## SAVE THESE INSTRUCTIONS







**THIS MODEL IS FOR HOUSEHOLD USE ONLY. COMMERCIAL USE OF THIS UNIT VOIDS THE MANUFACTURER'S WARRANTY.**

## IMPORTANT INFORMATION

- To reduce the risk of a leaking condition, do not store where freezing may occur. Damage to internal components may result.
- Brush roll continues to turn while product is turned ON and handle is in use. To avoid damage to carpet, rugs, furniture and flooring, avoid tipping cleaner or setting it on furniture, fringed area rugs, or carpeted stairs during tool use.
- With brush roll on, do not allow cleaner to sit in one location for an extended period of time, as damage to floor can result.

## What's in the Box?

Standard accessories may vary by model. To identify what should be included with your purchase, please refer to the "Carton Contents" list located on the carton top flap.

					
Upper Body and Clean Water Tank	Lower Body with Dirty Water Tank	Handle	Hose & Tool Bag	Tools (vary by model)	Trial Formula

## Assembly

▶ Go to [global.BISSELL.com](http://global.BISSELL.com) for assembly videos.

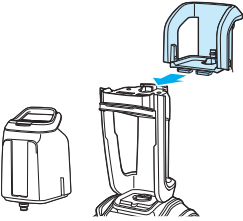
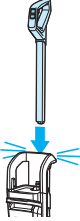
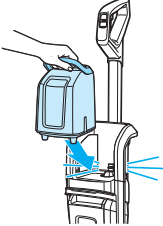

		
<p><b>1.</b> Remove clean tank from upper body. Ensure upper body is level with lower body. Tip machine forward and slide the upper body into the lower body from the back as shown.</p>	<p><b>2.</b> Insert handle into machine until it clicks into place.</p>	<p><b>3.</b> Insert clean tank into machine until it clicks into place.</p>

## Controls and Cleaning Modes

### Fingertip Controls



#### Mode

Switch between Steam Pretreat, SteamWash Max Clean, and Quick Dry modes. Mode selection appears on the foot display.



#### Power

Turn the machine ON and OFF.

### Foot Display & Cleaning Modes



#### Steam Pretreat Mode

Loosen tough stains before removing with SteamWash Max Clean mode.



#### SteamWash™ Max Clean Mode

Use water, formula and steam to clean your carpet.



#### Quick Dry Mode

Use water and formula for a quick clean. Carpets will dry in about 30 minutes.

# Filling the Clean Water Tank



This machine is compatible with BISSELL® formulas made for upright carpet cleaners. Always use genuine BISSELL formulas in your machine. Other formulas may harm the machine. **Note:** Fill with warm (140°F/60°C MAX) tap water and add the appropriate BISSELL® formula. Do not use boiling water. Do not heat water or tank in microwave.



Pretreat spots and stains to improve carpet cleaning performance.



Keep plenty of BISSELL cleaning formulas on hand so you can clean whenever it fits your schedule.

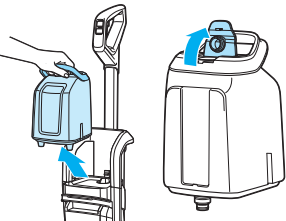
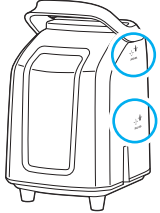
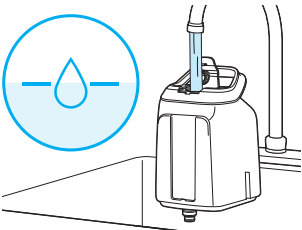
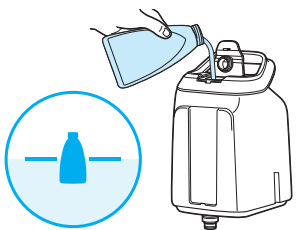
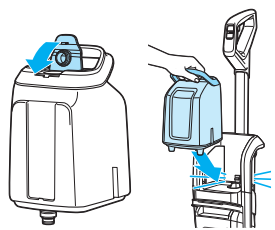

Add Boost carpet cleaning formula enhancers to any formula to increase its effectiveness.

		
<p><b>1.</b> Choose your formula.* Scan the QR code with your smartphone camera or visit <a href="http://global.BISSELL.com">global.BISSELL.com</a> for formulas.</p>	<p><b>2.</b> Lift tank to remove from machine. Flip open lid.</p>	<p><b>3.</b> Choose large or small area fill lines to suit your needs.</p>
		
<p><b>4.</b> Add <b>warm tap water</b> (140°F/60°C max) to water fill line. <b>Do not use boiling water. Do not heat water in microwave.</b></p>	<p><b>5.</b> Add <b>BISSELL formula</b> to formula fill line.</p>	<p><b>6.</b> Close lid until it clicks. Reinstall clean tank. It will click into place.</p>

\***Compatible formulas include:** Pro Stain & Odour, Pet Stain & Odour, Stain & Odour, Ambipur Blossom & Breeze, Pet Urine Eliminator + Oxy, Allergen

**⚠ WARNING** To reduce the risk of fire and electric shock due to internal component damage, use only BISSELL cleaning formula intended for use with this machine.

# Three Modes of Cleaning

▶ Visit [global.BISSELL.com](http://global.BISSELL.com) for how-to videos.



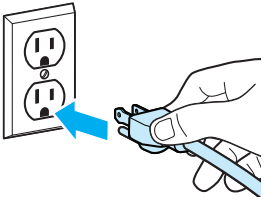
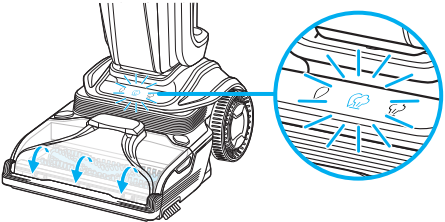

## Startup

- This appliance is primarily a carpet cleaner with a steam-cleaning feature.
- Remove any solids and use a dry vacuum cleaner over area before using your deep cleaner.
- To prevent damage to Berber-style carpets, avoid repeated strokes in the same area. Before cleaning area rugs, check the manufacturer's tag and test an inconspicuous spot on the rug for colorfastness. **Do not use on silk or delicate rugs.**
- Stay off carpet until dry.

	
<p><b>1.</b> Plug into a properly grounded outlet. Press power button on handle to turn ON.</p>	<p><b>2.</b> Water heater will turn on. Machine defaults to Steamwash Max mode with brush rolls and vacuum motor on. Icon on foot will blink then turn solid when heater is ready to make steam (&lt;60 seconds).</p>

## Steam Pretreat Mode

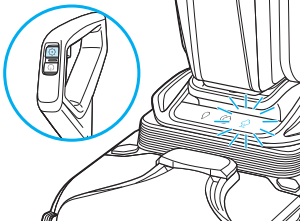
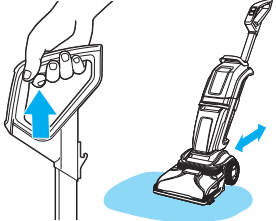
Loosen tough stains before removing with SteamWash Max Clean mode. **Brush rolls and vacuum motor will shut off** in this mode.

		
<p><b>1.</b> Press mode button until Steam Pretreat icon is illuminated. Icon will blink until heater is ready to make steam.</p>	<p><b>2.</b> Press recline pedal to recline machine. <b>Pull trigger to release steam</b> and move machine forward and back over stain for 20 seconds.</p>	<p><b>3.</b> After steam pretreat, press mode button to clean the stain in SteamWash Max mode.</p>

CONTINUED ON NEXT PAGE ▶

## Three Modes of Cleaning (continued)

### SteamWash™ Max Clean Mode

Use water, formula, and steam to clean your carpet. **Steam is present but not visible in this mode.** Carpets will dry in about 8 hours.

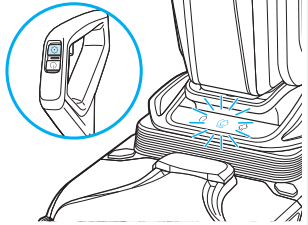
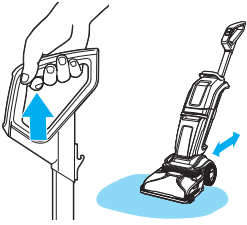
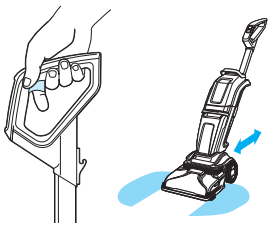
		
<p><b>1.</b> Press mode button until SteamWash Max Clean icon illuminates on foot. When ready, indicator light will stay illuminated.</p>	<p><b>2.</b> Press recline pedal to recline machine. <b>Pull trigger</b> to dispense water, formula, and steam. While holding trigger, make two “wet passes,” moving machine forward and back across carpet.</p>	<p><b>3.</b> <b>Release trigger</b> and make “dry passes” by pushing machine forward and back, at least two times, across carpet or until water can no longer be seen in nozzle.</p>

### Quick Dry Mode

Water and formula for a quick clean. Carpets will dry in about 30 minutes.

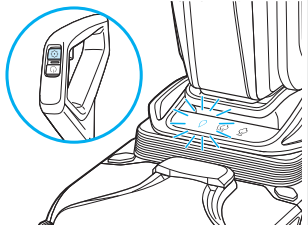
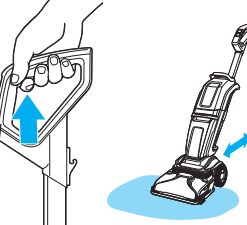
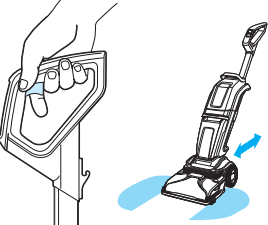
		
<p><b>1.</b> Press mode button until Quick Dry icon illuminates on foot.</p>	<p><b>2.</b> Press recline pedal to recline machine. <b>Pull trigger</b> to dispense water and formula. While holding trigger, make two “wet passes,” moving the machine forward and back across carpet.</p>	<p><b>3.</b> <b>Release trigger</b> and make “dry passes” by pushing machine forward and back, at least two times, across carpet or until water can no longer be seen in nozzle.</p>

# Cleaning with the Hose and Tools



**Note:** Only water and formula flows through hose and tool, not steam.

## Attaching the Hose

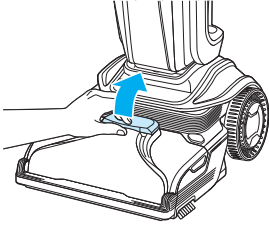
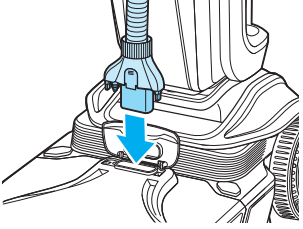
	
<p><b>1.</b> Lift accessory hose door on top of foot on the front of machine. Flip door toward machine to open.</p>	<p><b>2.</b> Insert hose until it clicks into place. Be sure colored hose release clip is facing out, away from machine. Attach tool to end of hose.</p>

## 2-in-1 Upholstery Tool

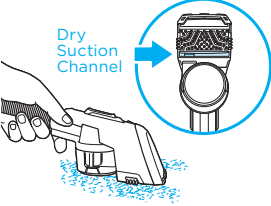
		
<p><b>1.</b> Switch between Dry and Wet settings and turn machine ON.</p>	<p><b>2a. Dry Cleaning</b> Vacuum up debris from carpet or upholstery.</p>	<p><b>2b. Wet Cleaning</b> Hold down trigger to activate spray. Release trigger and suction up the stain.</p>

## Cleaning the 2-in-1 Upholstery Tool

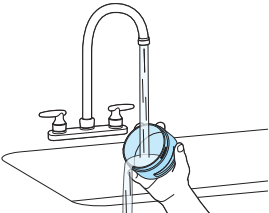
	
<p><b>1.</b> Twist dirt cup to open. Empty into a garbage bin.</p>	<p><b>2.</b> Rinse dirt cup. Let dry completely before reinstalling.</p>

CONTINUED ON NEXT PAGE ➔



### 3" and 6" Tool

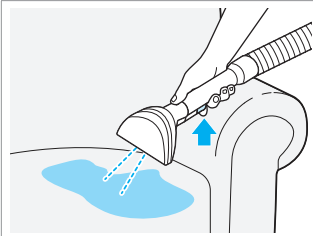

**1.** Point tool above spot or stain and press spray trigger.

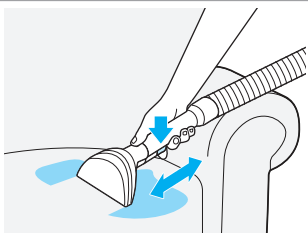

**2.** Release spray trigger and gently scrub the stain.

## After-Cleaning Care

For more helpful maintenance tips, check out [global.BISSELL.com](http://global.BISSELL.com).



### Emptying the Dirty Water Tank

**Note:** When the tank is full, the float will shut off suction and emit a high-pitched sound indicating it is time to empty your tank.

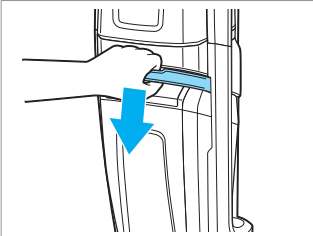

**1.** To release dirty water tank, press down on tank handle and tilt tank toward you.



**2.** Remove tank and carry to disposal area.

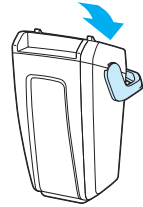

**3.** Unlock by rotating handle back.

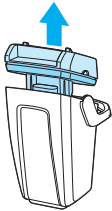

**4.** Grab lid in recessed area on both sides and pull up to remove.



**5.** Empty dirty water into utility sink.  
Reinstall lid and rotate handle forward to lock in place.

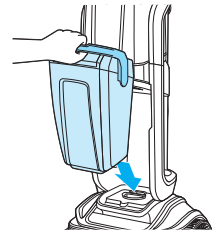

**6.** Reinstall tank. **Insert bottom first.** Then, tilt tank toward machine and push top in until it clicks into place.

## Cleaning the Machine

Nozzle may be HOT. Let machine cool before touching.

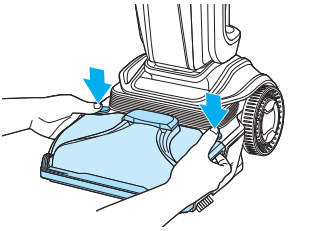
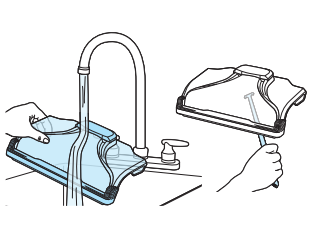
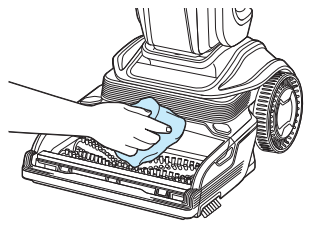
		
<p><b>1.</b> Place fingertips into grips on both sides of nozzle. Press release buttons with thumbs and rotate nozzle to remove.</p>	<p><b>2.</b> Open hose door. Rinse nozzle with warm water. Remove debris with clean out tool. <b>Note:</b> Parts are not dishwasher or automatic washing machine safe.</p>	<p><b>3.</b> If brush roll chamber is dirty, clean with a cloth.</p>

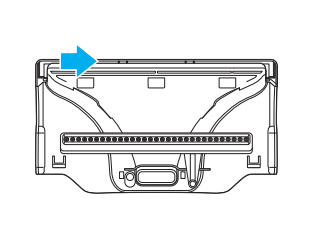
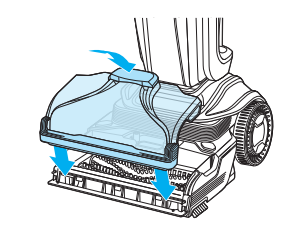
	
<p><b>4.</b> Check steam bar for clogs. Wipe underside of steam bar with a wet towel or manually remove visible clogs if necessary.</p>	<p><b>5.</b> Let nozzle dry before reassembling. Reinstall nozzle by first lining up tabs with grooves of foot. Rotate nozzle back into place until you feel two clicks.</p>

CONTINUED ON NEXT PAGE →

**⚠ WARNING** To reduce the risk of injury, do not touch the steam cleaning nozzle or adjacent surfaces when steam-cleaning or when the nozzle is heated.

## Using the Rinse and Storage Tray (select models)

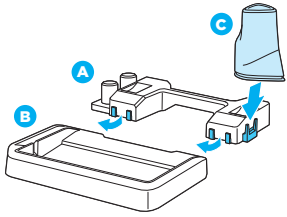
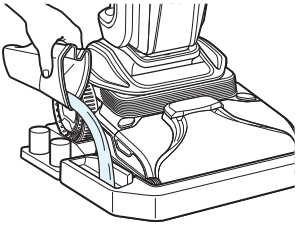
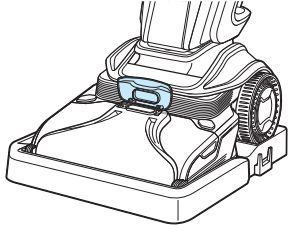
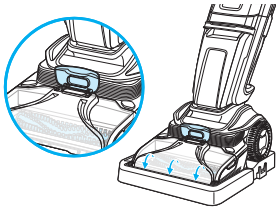
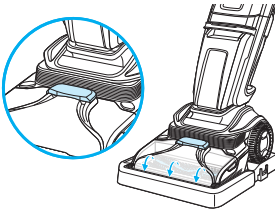
		
<p><b>1.</b> There are 2 hooks on each side of part A that hook under part B. Press B down onto A. The water cup (C) can be stored on the side of the tray.</p>	<p><b>2.</b> Place machine on tray. Fill rinse cup with fresh tap water to the fill line printed on cup. Pour water into tray as shown.</p>	<p><b>3.</b> Open hose door on foot.</p>
		
<p><b>4.</b> With hose tool door open, recline machine and press power button to turn ON. Run for 6-8 seconds to rinse brush rolls.</p>	<p><b>5.</b> Close hose tool door. Press power button to turn ON and run until all water is picked up. Repeat steps 3-4 until foam is completely rinsed. Press power button to turn machine OFF.</p>	

## Storing Your Machine

Once your cleaning is complete, make sure both the dirty and clean water tanks are emptied, rinsed out, and dried before the next use. Wrap cord around cord wrap for storage. Store machine in a protected, dry area.

# Replacing Belts and Brush Rolls

Scan the QR code for a how-to video.

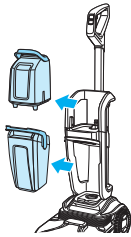

**1.** Unplug machine and remove both tanks. While reclined, lay machine on its front.

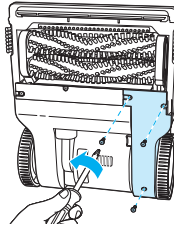

**2.** Remove belt cover. Use Phillips-head screwdriver to remove three screws.

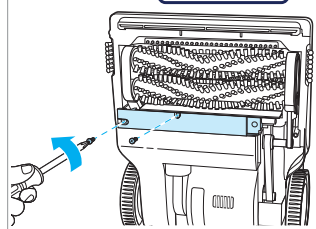

**3.** Use Phillips-head screwdriver to remove two screws. Then remove brush roll assembly by unhooking belt.

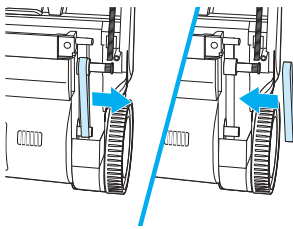

**4.** If flat belt is broken, place a new belt around red pulley. Stretch belt toward back of machine and around metal shaft.

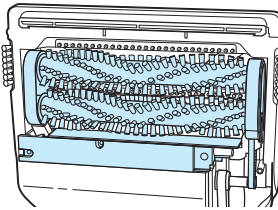

**5.** If brush roll belts or brush roll assembly is broken, replace with new brush roll assembly.

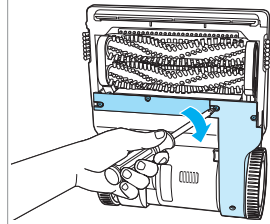

**6.** Reinstall brush roll assembly, making sure to loop belt over the shaft. Reinstall belt cover.

## Troubleshooting



Visit [global.BISSELL.com](http://global.BISSELL.com) or scan the QR code with your smartphone camera for troubleshooting.

**Note:** Any other servicing should be performed by an authorised service representative.

**⚠ WARNING** To reduce the risk of injury, do not touch the steam cleaning nozzle or adjacent surfaces when steam-cleaning or when the nozzle is heated.

# Limited Warranty

This limited warranty is provided by BISSELL® International Trading Company B.V. ("BISSELL") and applies in Australia and New Zealand. It gives you specific rights. It is offered as an additional benefit to your rights under law. You also have other rights under The Australian Consumer Law or New Zealand Consumer Laws, whichever applies to you. You can find out about your legal rights and remedies by contacting your local consumer advice service. Nothing in this warranty will replace or lessen any of your legal rights or remedies. If you need additional instruction regarding this warranty or have questions regarding what it may cover, please contact BISSELL Consumer Care or contact your local distributor.

This warranty is given to the current owner of the product with the original sales receipt. The original sales receipt must include the product(s) purchased, the date purchased, and which country it was purchased from new. You must be able to evidence the date of purchase and show the product was purchased in Australia or New Zealand to submit a claim under this warranty. You will receive the warranty that is applicable to the country where your product was originally purchased, as shown on the original sales receipt. If you use the product outside of the country where it was purchased, your warranty may be void in BISSELL's sole discretion. It may be necessary to obtain some of your personal information, such as a mailing address, to fulfill the terms of this warranty. Any personal data will be handled pursuant to BISSELL's Privacy Policy, which can be found at [global.BISSELL.com/privacy-policy](http://global.BISSELL.com/privacy-policy).

## Limited 2- or 3-Year Warranty (varies by model)

**Model 3670F:** Limited 2-Year Warranty

**Model 3672H:** Limited 3-Year Warranty

From the date of purchase by the original purchaser, subject to the "EXCEPTIONS AND EXCLUSIONS" identified below, BISSELL will repair or replace (with new, refurbished, lightly used, or remanufactured components or products), at BISSELL's option, free of charge, any defective or malfunctioning part or product.

BISSELL recommends that the original packaging and original proof of purchase with the date of purchase and country where purchased be kept for the duration of the warranty period in case you want to redeem the warranty during the warranty period. Keeping the original packaging will assist with any necessary re-packaging and transportation but is not a condition of the warranty.

If your product is replaced by BISSELL under this warranty, then the new item will benefit from the remainder of the term of this warranty (calculated from the date of the original purchase). The period of this warranty shall not be extended whether or not your product is repaired or replaced.

## \*Conditions of Warranty

This warranty applies to products used for personal domestic use and not commercial or hire purposes. Consumable components and attachments such as filters, belts, shells, water tanks, scraping strips, brushes, and mop pads, which must be replaced or serviced by the user from time to time, are not covered by this warranty.

This warranty does not apply to any defect arising from fair wear and tear, including but not limited to the battery discharging time shortening due to the aging or use. Damage or malfunction caused by the user or any third party whether as a result of accident, negligence, abuse, neglect, or any other use not in accordance with the user guide is not covered by this warranty. An unauthorised repair (or attempted repair) may void this warranty whether or not damage has been caused by that

repair/attempt. Removing or tampering with the Product Rating Label on the product or rendering it illegible will void this warranty.

Except as set out below, BISSELL and its distributors are not liable for any loss or damage that is not foreseeable or for incidental or consequential damages of any nature associated with the use of this product including without limitation loss of profit, loss of business, business interruption, loss of opportunity, distress, inconvenience, or disappointment. Except as set out below, BISSELL's liability will not exceed the purchase price of the product.

BISSELL does not exclude or limit in any way its liability for (a) death or personal injury caused by our negligence or the negligence of our employees, agents or subcontractors; (b) fraud or fraudulent misrepresentation; (c) or for any other matter which cannot be excluded or limited under law.

To make a claim under this warranty contact BISSELL Australia PTY LTD (details below). Contact BISSELL prior to returning any goods. Where agreed, BISSELL will reimburse reasonable postage / handling costs (if any) for returning goods to BISSELL. To claim expenses incurred in making a claim under this warranty please provide BISSELL with a copy of the receipt of the expenses by email or post.

For Australian Consumers Only: Our goods come with guarantees that cannot be excluded under the Australian Consumer Law. You are entitled to a replacement or refund for a major failure and compensation for any other reasonably foreseeable loss or damage. You are also entitled to have the goods repaired or replaced if the goods fail to be of acceptable quality and the failure does not amount to a major failure.

## Important Notes

Please keep your original sales receipt. It provides proof of the date of purchase and where it was purchased in the event of a warranty claim. See warranty for details.

Please note that using your BISSELL machine outside of its country of original purchase and/or use with a power converter may damage your BISSELL machine and damage caused by mismatched power voltage will not be covered by your warranty.

Please note that putting vinegar, bleach, dish soap, detergent, homemade soap, and other non-BISSELL products in your BISSELL machine may damage your BISSELL machine. Damage caused by using non-BISSELL products in your machine will not be covered by your warranty.

## Consumer Care

If your BISSELL product should require service or to claim under our limited guarantee, please contact us.

### Australia

Telephone: 1300 247 735

Website: [BISSELL.com.au](http://BISSELL.com.au)

Address: 789 Springvale Road, Mulgrave, Victoria 3170

Email: [consumercareau@bissell.com](mailto:consumercareau@bissell.com)

### New Zealand

Telephone: 0800 247 735

Website: [BISSELL.co.nz](http://BISSELL.co.nz)

Address: 789 Springvale Road, Mulgrave, Victoria 3170

Email: [consumercarenz@bissell.com](mailto:consumercarenz@bissell.com)