



# Dryers

**Safety Information**..... 2-5

**Operating Instructions**

Control Panel.....6, 7

Loading and Using  
the Dryer.....9

Reversing the Door.....8

Venting the Dryer ..... 10

**Troubleshooting Tips**..... 11, 12

**Consumer Support**

Consumer Support.....Back Cover

Warranty ..... 15

**Owner's Manual**

Model: Type 450

**Write the model and serial numbers here:**

**Model #** \_\_\_\_\_

**Serial #** \_\_\_\_\_

They are on the label on the front of the dryer behind the door.

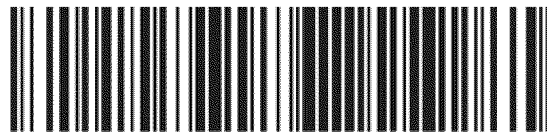

234D2241P001 49-90507 10-13 GE

# IMPORTANT SAFETY INFORMATION. READ ALL INSTRUCTIONS BEFORE USING.

## **⚠ WARNING!**

*For your safety, the information in this manual must be followed to minimize the risk of fire or explosion, electric shock, or to prevent property damage, personal injury, or death.*

*Installation and service must be performed by a qualified installer, service agency or the gas supplier.*

### **FOR GAS DRYERS: YOU MUST POST IN A PROMINENT LOCATION**

- 1. Instructions to follow if the user smells gas: Contact your local gas supplier for information to be displayed.*
- 2. Instructions concerning flammable materials as follows:*

### **FOR YOUR SAFETY**

***Do not store or use gasoline or other flammable vapors and liquids in the vicinity of this or any other appliance.***

### *California Safe Drinking Water and Toxic Enforcement Act*

*This act requires the governor of California to publish a list of substances known to the state to cause cancer, birth defects or other reproductive harm and requires businesses to warn customers of potential exposure to such substances.*

*Gas appliances can cause minor exposure to four of these substances, namely benzene, carbon monoxide, formaldehyde and soot, caused primarily by the incomplete combustion of natural gas or LP fuels.*

*Properly adjusted dryers will minimize incomplete combustion. Exposure to these substances can be minimized further by properly venting the dryer to the outdoors.*



## PROPER INSTALLATION

This dryer must be properly installed and located in accordance with the Installation Instructions before it is used. If you did not receive an Installation Instructions sheet, visit our Website at: [GEAppliances.com](http://GEAppliances.com).

- Properly ground dryer to conform with all governing codes and ordinances. Follow details in Installation Instructions.
- Install or store where it will not be exposed to temperatures below freezing or exposed to the weather.
- Connect to a properly rated, protected and sized power supply circuit to avoid electrical overload.
- Remove the colored protective film from the control panel.
- Remove all sharp packing items and dispose of all shipping materials properly.

Exhaust/Ducting:

- 1 Gas dryers **MUST** be exhausted to the outside.
- 2 Use only rigid metal 4" diameter ductwork inside the dryer cabinet. Use only rigid metal or flexible metal 4" diameter ductwork for exhausting to the outside. **USE OF PLASTIC OR OTHER COMBUSTIBLE DUCTWORK CAN CAUSE A FIRE. PUNCTURED DUCTWORK CAN CAUSE A FIRE IF IT COLLAPSES OR BECOMES OTHERWISE RESTRICTED IN USE OR DURING INSTALLATION.**

For complete details, follow the Installation Instructions.



## YOUR LAUNDRY AREA

- Keep the area underneath and around your appliances free of combustible materials (lint, paper, rags, etc.), gasoline, chemicals and other flammable vapors and liquids.
- Keep the floor around your appliances clean and dry to reduce the possibility of slipping.
- Close supervision is necessary if this appliance is used by or near children. Do not allow children to play on, with or inside this or any other appliance.
- Keep all laundry aids (such as detergents, bleaches, etc.) out of the reach of children, preferably in a locked cabinet. Observe all warnings on container labels to avoid injury.
- Never climb on or stand on the dryer top.

# IMPORTANT SAFETY INFORMATION. READ ALL INSTRUCTIONS BEFORE USING.

## ⚠️ WARNING!



### WHEN USING YOUR DRYER

- Never reach into the dryer while the drum is moving. Before loading, unloading or adding clothes, wait until the drum has completely stopped.
- Clean the lint filter before each load to prevent lint accumulation inside the dryer or in the room. **DO NOT OPERATE THE DRYER WITHOUT THE LINT FILTER IN PLACE.**
- Do not wash or dry articles that have been cleaned in, washed in, soaked in or spotted with combustible or explosive substances (such as wax, oil, paint, gasoline, degreasers, dry-cleaning solvents, kerosene, etc.). These substances give off vapors that may ignite or explode. Do not add these substances to the wash water. Do not use or place these substances around your washer or dryer during operation.
- Do not place items exposed to cooking oils in your dryer. Items contaminated with cooking oils may contribute to a chemical reaction that could cause a clothes load to catch fire.
- Any article on which you have used a cleaning solvent or that contains flammable materials (such as cleaning cloths, mops, towels used in beauty salons, restaurants or barber shops, etc.) must not be placed in or near the dryer until solvents or flammable materials have been removed. There are many highly flammable items used in homes such as acetone, denatured alcohol, gasoline, kerosene, some household cleaners, some spot removers, turpentine, waxes, wax removers and products containing petroleum distillates.
- The laundry process can reduce the flame retardancy of fabrics. To avoid such a result, carefully follow the garment manufacturer's care instructions.
- Do not dry articles containing rubber, plastic, foam or similar materials such as padded bras, tennis shoes, galoshes, bath mats, rugs, bibs, baby pants, plastic bags, pillows, etc., that may melt or burn. Some rubber materials, when heated, can under certain circumstances produce fire by spontaneous combustion.
- Do not store plastic, paper or clothing that may burn or melt on top of the dryer during operation.
- Garments labeled *Dry Away from Heat* or *Do Not Tumble Dry* (such as life jackets containing Kapok) must not be put in your dryer.
- Do not dry fiberglass articles in your dryer. Skin irritation could result from the remaining particles that may be picked up by clothing during subsequent dryer uses.
- To minimize the possibility of electric shock, unplug this appliance from the power supply or disconnect the dryer at the building's distribution panel by removing the fuse or switching off the circuit breaker before attempting any maintenance or cleaning (except the removal and cleaning of the lint filter).  
**NOTE:** Pressing **PAUSE** or **STOP/CANCEL** does **NOT** disconnect the appliance from the power supply.

- Never attempt to operate this appliance if it is damaged, malfunctioning, partially disassembled, or has missing or broken parts, including a damaged cord or plug.
- The interior of the machine and the exhaust duct connection inside the dryer should be cleaned at least once a year by a qualified technician. See the *Loading and Using the Dryer* section.
- If yours is a gas dryer, it is equipped with an automatic electric ignition and does not have a pilot light. **DO NOT ATTEMPT TO LIGHT WITH A MATCH.** Burns may result from having your hand in the vicinity of the burner when the automatic ignition turns on.
- You may wish to soften your laundered fabrics or reduce the static electricity in them by using a dryer-applied fabric softener or an anti-static conditioner. We recommend you use either a fabric softener in the wash cycle, according to the manufacturer's instructions for those products, or try a dryer-added product for which the manufacturer gives written assurance on the package that their product can be safely used in your dryer. Service or performance problems caused by use of these products are the responsibility of the manufacturers of those products and are not covered under the warranty to this appliance.



## WHEN NOT USING YOUR DRYER

- Grasp the plug firmly when disconnecting this appliance to avoid damage to the cord while pulling. Place the cord away from traffic areas so it will not be stepped on, tripped over or subjected to damage.
- Do not attempt to repair or replace any part of this appliance or attempt any servicing unless specifically recommended in this Owner's Manual or in published user-repair instructions that you understand and have the skills to carry out.
- Before discarding a dryer, or removing it from service, remove the dryer door to prevent children from hiding inside.
- Do not tamper with controls.



**READ AND FOLLOW THIS SAFETY INFORMATION CAREFULLY.  
SAVE THESE INSTRUCTIONS**

## About the control panel.

Your new dryer offers the convenience of starting your dryer loads by simply choosing a Clothes Care Selection and the Heat Setting. Then all you have to do is press **START**.

### Quick Start Guide

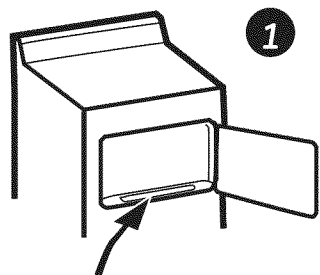

- Clean lint filter

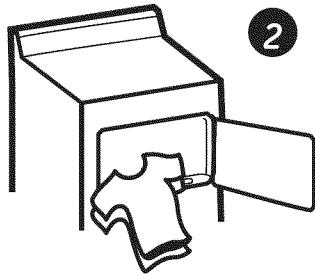

- Add clothes

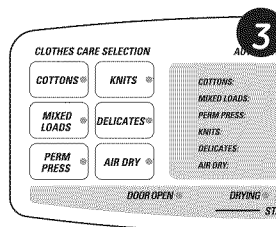

- Select dry cycle
- Select heat setting

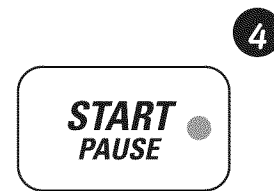

- Close door
- Push **START**

### Model Type 450

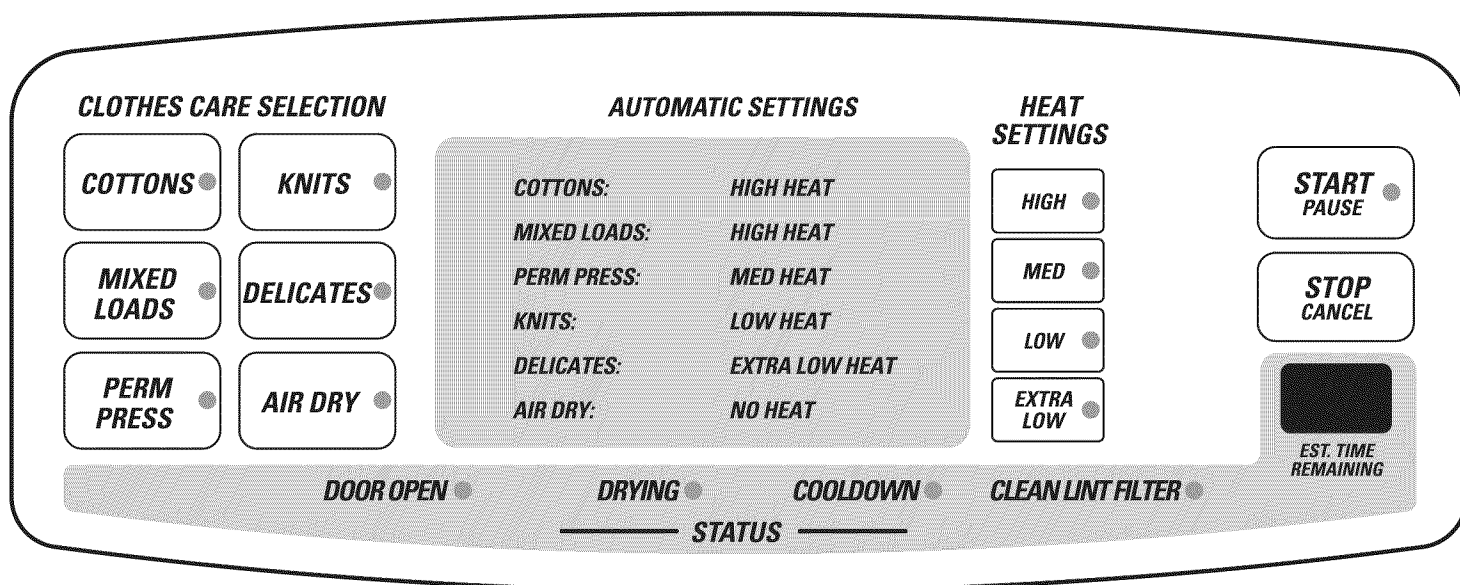

**NOTE:** Any time you make a selection that is incompatible with the chosen dry cycle, the dryer will beep twice.

### Vision-Impaired Washer/Dryer Kit

For washer model WNRD2050 and dryer model DNCD450, a kit is available for the vision-impaired containing Braille overlays that fit over the pads on the washer and dryer control panels.

Included in the kit are:

- Braille overlays for the washer and dryer control panels
- Braille Reference Keys that explain the operation of the washer and dryer
- Use and Care Audio Tape

Order publication number 14-D242, available from your GE supplier.

## 1 Clothes Care Selection

**COTTONS**

For cottons and most linens.

**MIXED LOADS**

For loads consisting of cottons and poly-blends.

**PERM PRESS**

For wrinkle-free and permanent press items.

**KNITS**

For knits and sweaters with fabric care labels that say "Machine Dry."

**DELICATES**

For lingerie and special care fabrics.

**AIR DRY**

For tumbling items without heat.

## 2 Heat Settings

**HIGH**

For regular to heavy cottons.

**MED**

For synthetics, blends and items labeled permanent press.

**LOW**

For delicates, synthetics and items labeled Tumble Dry Low.

**EXTRA LOW**

For lingerie and special-care fabrics.

## 3 START/PAUSE

Press **START** to begin the cycle.

**START PAUSE**

- Press twice to select the last cycle you used and start the dryer.
- If you have selected a new cycle, press once to start the cycle.
- If the dryer is running, press once to interrupt the cycle; press again to continue the cycle.

**STOP CANCEL**

### STOP/CANCEL

- This pad should **not** be used to interrupt or pause a cycle.
- Pressing this pad will cancel the current settings and the settings will be lost.



**EST. TIME REMAINING**



**EST. TIME REMAINING**

"Racetrack lights"

### Estimated Time Remaining

As the cycle begins, you will see the approximate total cycle time in the display. Then "racetrack lights" will flash in the display, in a clockwise direction. This means the dryer is continuously monitoring the amount of moisture in the load. The racetrack lights will continue until the dryer senses a low level of moisture in the load. At that point, the dryer will calculate and display the approximate time remaining.

# About reversing the door.

## Reversing the Door

Tools needed:

- Standard #2 Phillips screwdriver
- Tape-tipped putty knife

**1** Open the door and remove the filler plugs opposite the hinges. With the door completely open, remove the bottom screw from each hinge on the dryer face. Insert these screws about half way into the **TOP** holes, for each hinge, on the opposite side (where you removed the filler plugs). Apply firm pressure to get the screw started in new holes.

REMOVE 4 PLUGS AND KEEP FOR INSERTION INTO THE OPPOSITE SIDE

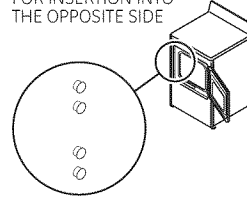

REMOVE **BOTTOM** SCREW FROM EACH HINGE AND INSTALL HALF WAY INTO EACH **TOP** OF OPPOSITE HINGE HOLES

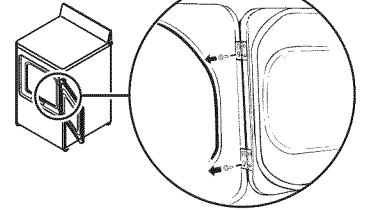

**2** Loosen top screw from each hinge on the dryer face half way. With one hand holding the top of the door and the other hand holding the bottom, remove the door from the dryer by lifting it **UP** and **OUT**.

LOOSEN EACH TOP HINGE SCREW HALF WAY AND LIFT THE DOOR UP AND OFF

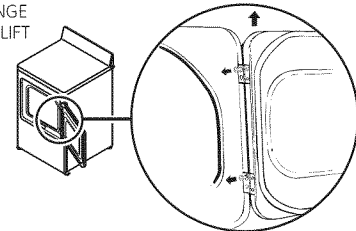

**3** Remove the blind plate from the hinge side of the dryer by removing its two screws. Remove the strike plate from the opposite side of the dryer by removing its two screws. Reinstall the plates, on the opposite sides, using two screws in each plate.

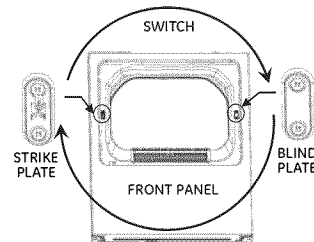

**4** Rotate the door 180°. Insert it on the opposite side of the opening by moving the door **IN** and **DOWN** until the top hinge and the bottom hinge are resting on the top screws inserted in step 1.

ROTATE DOOR 180° AND HANG IT ON TOP HINGE SCREWS

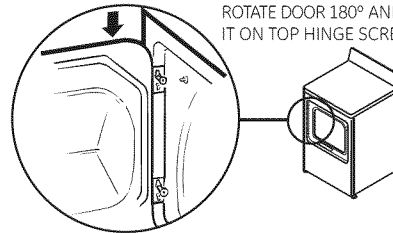

**5** Remove the remaining screws from the side of the opening from which the door was removed. With these screws, secure each hinge at the bottom. Tighten the two top screws of each hinge. Reinsert the plastic plugs on the side from which the door was removed.

INSTALL AND TIGHTEN BOTTOM SCREWS AND TIGHTEN TOP SCREWS

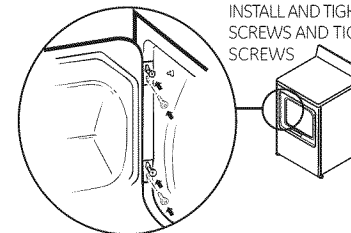

INSERT PLUGS INTO HOLES ON OPPOSITE SIDE

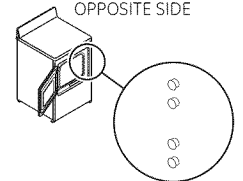

## Loading and using the dryer.

Always follow the fabric manufacturer's care label when laundering.



### Sorting and Loading Hints

As a general rule, if clothes are sorted properly for the washer, they are sorted properly for the dryer. Try also to sort items according to size. For example, do not dry a sheet with socks or other small items.

Do not add fabric softener sheets once the load has become warm. They may cause fabric softener stains. Bounce® Fabric Conditioner Dryer Sheets have been approved for use in all GE Dryers when used in accordance with the manufacturer's instructions.

**Do not overload.** This wastes energy and causes wrinkling.

**Do not dry the following items:** fiberglass items, woolens, rubber-coated items, plastics, items with plastic trim and foam-filled items.



### Care and Cleaning of the Dryer

**The Exterior:** Wipe or dust any spills or washing compounds with a damp cloth. Dryer control panel and finishes may be damaged by some laundry pretreatment soil and stain remover products. Apply these products away from the dryer. The fabric may then be washed and dried normally. Damage to your dryer caused by these products is not covered by your warranty.

**The Lint Filter:** Clean the lint filter before each use. Moisten your fingers and reach into the filter opening. Run your fingers across the filter. Have a qualified technician vacuum the lint from the dryer once a year.

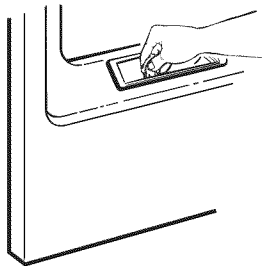

**The Exhaust Duct:** Inspect and clean the exhaust ducting at least once a year to prevent clogging. A partially clogged exhaust can lengthen the drying time.

Follow these steps:

- 1 Turn off electrical supply by disconnecting the plug from the wall socket.
- 2 Disconnect the duct from the dryer.
- 3 Vacuum the duct with the hose attachment and reconnect the duct.

**The Exhaust Hood:** Check from the outside that the flaps of the hood move freely when operating. Make sure that there is no wildlife (birds, insects, etc.) nesting inside the duct or hood.

## Venting the dryer.

For the best drying performance the dryer needs to be properly vented. ***The dryer will use more energy and run longer if it is not vented to the below specifications. Carefully follow the details on Exhausting in the Installation Instructions.***

- Use only rigid metal 4" diameter ductwork inside the dryer cabinet. Use only rigid metal or flexible metal 4" diameter ductwork for exhausting to the outside.
- Do not use plastic or other combustible ductwork.
- Use the shortest length possible.
- Do not crush, kink or collapse the duct.
- Avoid resting the duct on sharp objects.
- ***Venting must conform to local building codes.***

*Correct Venting*

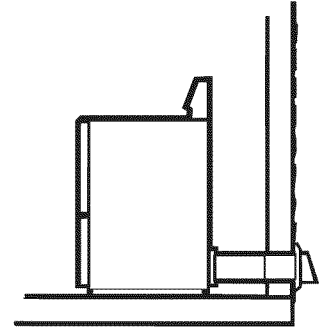
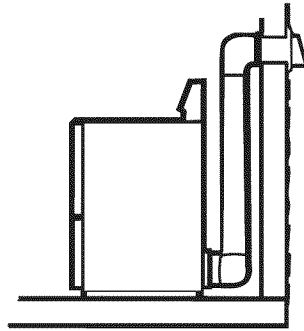

*Incorrect Venting*

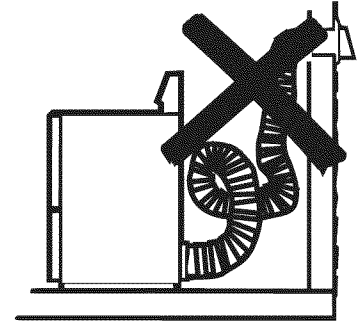
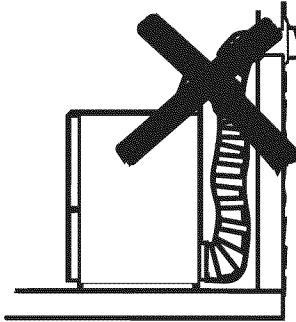

# Before you call for service...



*Troubleshooting Tips*  
 Save time and money! Review the charts on the following pages first and you may not need to call for service.

OPERATION	Possible Causes	What To Do
Control pads not responding	Controls accidentally put in service mode	<ul style="list-style-type: none"> <li>Press <b>STOP/CANCEL</b>.</li> </ul>
Dryer doesn't start	Control panel is "asleep"	<ul style="list-style-type: none"> <li>This is normal. Press <b>START</b> twice to choose the last cycle you used and to start the dryer.</li> </ul>
	Dryer is unplugged	<ul style="list-style-type: none"> <li>Make sure the dryer plug is pushed completely into the outlet.</li> </ul>
	Fuse is blown/circuit breaker is tripped	<ul style="list-style-type: none"> <li>Check the building's fuse/circuit breaker box and replace fuse or reset breaker. <b>NOTE:</b> Most electric dryers use two fuses/breakers.</li> </ul>
Dryer doesn't heat	Fuse is blown/circuit breaker is tripped; the dryer may tumble but not heat	<ul style="list-style-type: none"> <li>Check the building's fuse/circuit breaker box and replace both fuses or reset both breakers. Your dryer may tumble if only one fuse is blown or one breaker tripped.</li> </ul>
	Gas service is off	<ul style="list-style-type: none"> <li>Make sure gas shutoff at dryer and main shutoff are fully open.</li> </ul>
Dryer shakes or makes noise	Some shaking/noise is normal. Dryer may be sitting unevenly	<ul style="list-style-type: none"> <li>Move dryer to an even floor space, or adjust leveling legs as necessary until even.</li> </ul>
Inconsistent drying times	Type of heat	<ul style="list-style-type: none"> <li>Drying time will vary according to the type of heat used (electric, natural or LP gas), size of load, types of fabrics, wetness of clothes and condition of exhaust ducts.</li> </ul>
No numbers displayed during cycle, only "racetrack" lights	Dryer is continuously monitoring the amount of moisture in the clothes	<ul style="list-style-type: none"> <li>This is normal. When the dryer senses a low level of moisture in the load, the dryer will display the dry time remaining.</li> </ul>
Clothes are still wet and dryer shut off after a short time	The door was opened mid-cycle. The load was then removed from the dryer and a new load put in without selecting a new cycle	<ul style="list-style-type: none"> <li>A dry cycle must be reselected each time a new load is put in.</li> </ul>
	Dryer is not level.	<ul style="list-style-type: none"> <li>Move dryer to an even floor space or adjust leveling legs as necessary until even.</li> </ul>
Cannot make a selection and the dryer beeps twice	The <b>HEAT SETTING</b> that you are trying to select is incompatible with the chosen dry cycle	<ul style="list-style-type: none"> <li>This is normal.</li> </ul>
LAUNDRY PRACTICES	Possible Causes	What To Do
Clothes are wrinkled	Overdrying	<ul style="list-style-type: none"> <li>Remove items while they still hold a slight amount of moisture.</li> </ul>
	Overloading	<ul style="list-style-type: none"> <li>Separate large loads into smaller ones.</li> </ul>
Clothes shrink	Some fabrics will naturally shrink when washed. Others can be safely washed, but will shrink in the dryer.	<ul style="list-style-type: none"> <li>To avoid shrinkage, follow garment care labels exactly.</li> <li>Some items may be pressed back into shape after drying.</li> <li>If you are concerned about shrinkage in a particular item, do not machine wash or tumble dry it.</li> </ul>



## Before you call for service...



### Troubleshooting Tips

LAUNDRY PRACTICES	Possible Causes	What To Do
Greasy spots on clothes	Improper use of fabric softener	<ul style="list-style-type: none"> <li>Follow directions on fabric softener package.</li> </ul>
	Drying dirty items with clean ones	<ul style="list-style-type: none"> <li>Use your dryer to dry only clean items. Dirty items can stain clean items and the dryer.</li> </ul>
	Clothes were not completely clean	<ul style="list-style-type: none"> <li>Sometimes stains which cannot be seen when the clothes are wet <i>appear</i> after drying. Use proper washing procedures before drying.</li> </ul>
Lint on clothes	Lint filter is full	<ul style="list-style-type: none"> <li>Clean lint screen before each load.</li> </ul>
	Improper sorting	<ul style="list-style-type: none"> <li>Sort lint producers (like chenille) from lint collectors (like corduroy).</li> </ul>
	Static electricity can attract lint	<ul style="list-style-type: none"> <li>See suggestions in this section under <b>STATIC</b>.</li> </ul>
	Overloading	<ul style="list-style-type: none"> <li>Separate large loads into smaller ones.</li> </ul>
Static occurs	Paper, tissue, etc., left in pockets	<ul style="list-style-type: none"> <li>Empty all pockets before laundering clothes.</li> </ul>
	No fabric softener was used	<ul style="list-style-type: none"> <li>Try a fabric softener.</li> <li>Bounce® Fabric Conditioner Dryer Sheets have been approved for use in all GE Dryers when used in accordance with the manufacturer's instructions.</li> </ul>
	Overdrying	<ul style="list-style-type: none"> <li>Try a fabric softener.</li> <li>Adjust controls for less drying.</li> </ul>
Clothes take too long to dry	Synthetics, permanent press and blends can cause static	<ul style="list-style-type: none"> <li>Try a fabric softener.</li> </ul>
	Improper sorting	<ul style="list-style-type: none"> <li>Separate heavy items from lightweight items (generally, a well-sorted washer load is a well-sorted dryer load).</li> </ul>
Clothes take too long to dry	Large loads of heavy fabrics (like beach towels)	<ul style="list-style-type: none"> <li>Large, heavy fabrics contain more moisture and take longer to dry. Separate large, heavy fabrics into smaller loads to speed drying time.</li> </ul>
	Controls improperly set	<ul style="list-style-type: none"> <li>Match control settings to the load you are drying.</li> </ul>
	Lint filter is full	<ul style="list-style-type: none"> <li>Clean lint filter before every load.</li> </ul>
	Improper or obstructed ducting	<ul style="list-style-type: none"> <li>Check installation instructions for proper ducting/venting.</li> <li>Make sure ducting is clean, free of kinks and unobstructed.</li> <li>Check to see if outside wall damper operates easily.</li> <li>Check the Installation Instructions to make sure the dryer venting is correct.</li> </ul>
	Blown fuses or tripped circuit breaker	<ul style="list-style-type: none"> <li>Replace fuses or reset circuit breakers. Since most dryers use 2 fuses/breakers, make sure both are operating.</li> </ul>
	Overloading/combining loads	<ul style="list-style-type: none"> <li>Do not put more than one washer load in the dryer at a time.</li> </ul>
	Underloading	<ul style="list-style-type: none"> <li>If you are drying only one or two items, add a few items to ensure proper tumbling.</li> </ul>

Notes.

---

<i>Safety Instructions</i>	<i>Operating Instructions</i>	<i>Troubleshooting Tips</i>	<i>Consumer Support</i>
----------------------------	-------------------------------	-----------------------------	-------------------------



Consumer Support	Troubleshooting Tips	Operating Instructions	Safety Instructions
------------------	----------------------	------------------------	---------------------

*Notes.*

---

# GE Commercial Dryer Warranty.



Parts and service are available from your General Electric Commercial Laundry distributor.

Please have serial number and model number available when calling for service.

For The Period Of:	We Will Replace:
<b>One Year</b> From the date of the original purchase	<b>Any part</b> of the dryer which fails due to a defect in materials or workmanship. During this <b>limited one-year warranty</b> , we will also provide, <b>free of charge</b> , all labor and related service costs to replace the defective part.
<b>Second through Fifth Year</b> From the date of the original purchase	<b>Any extra large or super capacity dryer drum</b> which fails due to a defect in materials or workmanship. During this <b>additional four-year limited warranty</b> , you will be responsible for any labor and related service costs.

## What Is Not Covered:

- Service trips to your place of business to teach you how to use the product.
- Improper installation, delivery or maintenance.
- Failure of the product if it is abused, misused, or used for other than the intended purpose.
- Any and all implied warranties of merchantability and fitness for a particular purpose.
- Replacement of fuses or resetting of circuit breakers
- at place of business.
- Damage to the product caused by accident, fire, floods or acts of God.
- Incidental or consequential damage caused by possible defects with this appliance.
- Damage caused after delivery.
- Product not accessible to provide required service.

**EXCLUSION OF IMPLIED WARRANTIES—Your sole and exclusive remedy is product repair as provided in this Limited Warranty. Any implied warranties, including the implied warranties of merchantability or fitness for a particular purpose, are limited to one year or the shortest period allowed by law.**

This warranty is extended to the original purchaser and any succeeding owner for products purchased for commercial use within the USA. If the product is located in an area where service by a GE Authorized Servicer is not available, you may be responsible for a trip charge or you may be required to bring the product to an Authorized GE Service location for service. In Alaska, the warranty excludes the cost of shipping to your place of business.

Some states do not allow the exclusion or limitation of incidental or consequential damages. This warranty gives you specific legal rights, and you may also have other rights which vary from state to state. To know what your legal rights are, consult your local or state consumer affairs office or your state's Attorney General.

**Warrantor: General Electric Company, Louisville, KY 40225**



## Consumer Support.

---



### GE Appliances Website

**GEAppliances.com**

Have a question or need assistance with your appliance? Try the GE Appliances Website 24 hours a day, any day of the year! For greater convenience and faster service, you can now download Owner's Manuals, order parts or even schedule service on-line.

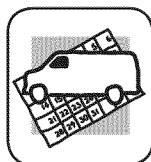

### Schedule Service

**GEAppliances.com**

Expert GE repair service is only one step away from your door. Get on-line and schedule your service at your convenience 24 hours any day of the year! Or call 800.GE.CARES (800.432.2737) during normal business hours.

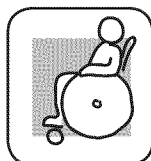

### Real Life Design Studio

**GEAppliances.com**

GE supports the Universal Design concept—products, services and environments that can be used by people of all ages, sizes and capabilities. We recognize the need to design for a wide range of physical and mental abilities and impairments. For details of GE's Universal Design applications, including kitchen design ideas for people with disabilities, check out our Website today. For the hearing impaired, please call 800.TDD.GEAC (800.833.4322).



### Extended Warranties

**GEAppliances.com**

Purchase a GE extended warranty and learn about special discounts that are available while your warranty is still in effect. You can purchase it on-line anytime, or call 800.626.2224 during normal business hours. GE Consumer Home Services will still be there after your warranty expires.

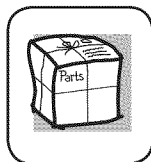

### Parts and Accessories

**GEAppliances.com**

Individuals qualified to service their own appliances can have parts or accessories sent directly to their homes (VISA, MasterCard and Discover cards are accepted). Order on-line today, 24 hours every day or by phone at 800.626.2002 during normal business hours.

***Instructions contained in this manual cover procedures to be performed by any user. Other servicing generally should be referred to qualified service personnel. Caution must be exercised, since improper servicing may cause unsafe operation.***



### Contact Us

**GEAppliances.com**

If you are not satisfied with the service you receive from GE, contact us on our Website with all the details including your phone number, or write to: General Manager, Customer Relations  
GE Appliances, Appliance Park  
Louisville, KY 40225



### Register Your Appliance

**GEAppliances.com**

**Register your new appliance on-line—at your convenience!** Timely product registration will allow for enhanced communication and prompt service under the terms of your warranty, should the need arise. You may also mail in the pre-printed registration card included in the packing material.