

**Kelvinator** 

Window Wall (Manual) Room Air Conditioner

User Manual

KWH16CMF

Refrigerant R32



## Congratulations

Congratulations and thank you for choosing our Manual Window Wall room air conditioner. We are sure you will find your new air conditioner a pleasure to use. Before you use the air conditioner, we recommend that you read through the entire user manual, which provides the description of the air conditioner and its functions.

To avoid the risks that are always present when you use an electrical appliance, it is important that the air conditioner is installed correctly and that you read the safety instructions carefully to avoid misuse and hazards.

We recommend that you keep this instruction booklet for future reference and pass it on to any future owners.

After unpacking the air conditioner please check it is not damaged. If in doubt, do not use the air conditioner but contact your local Electrolux Customer Care Centre.

### environmental tip

#### Information on disposal for users

- Most of the packing materials are recyclable. Please dispose of those materials through your local recycling depot or by placing them in appropriate collection containers.
- If you wish to discard this air conditioner, please contact your local authorities and ask for the correct method of disposal.
- This product contains refrigerant which must be reclaimed by a licensed refrigeration mechanic before the product can be disposed of.

### warning

This unit uses refrigerant R32 and must be disposed of by a licensed refrigeration mechanic with knowledge of appropriate gas reclamation methods.

Do not use means to accelerate defrosting or to clean, other than those recommended by the manufacturer. The appliance shall not be stored in a room with continuously operating ignition sources. Do not pierce or burn.

### caution

- The air conditioner is not intended for use by young children or infirm persons without supervision.
- Young children should be supervised to ensure that they do not play with the air conditioner.
- Contact an authorised installer for installation of this unit.
- Contact an authorised service technician for repair or maintenance of this unit.
- If the power cord is to be replaced, replacement work must be performed by authorised personnel only.
- Installation work must be performed in accordance with the national wiring Standards by authorised personnel only.

## Contents

Safety precautions .....	3
Prior to operation.....	4
Unit parts identification.....	5
Air conditioner features .....	5
Care and cleaning .....	7
Specifications .....	8
Installation .....	8
Troubleshooting .....	10

### Important information that may impact your Manufacturer's Warranty

Adherence to the directions for use in this manual is extremely important for health and safety. Failure to strictly adhere to the requirements in this manual may result in personal injury, property damage and affect your ability to make a claim under the Kelvinator manufacturer's warranty provided with your product. Products must be used, installed and operated in accordance with this manual. You may not be able to claim on the Kelvinator manufacturer's warranty in the event that your product fault is due to failure to adhere to this manual.

## Safety precautions

### **caution**

- Contact an authorised service technician for repair or maintenance of this unit.
- Contact an authorised installer for installation of this unit.
- This air conditioner is not intended for use by young children or infirm persons without supervision.
- Young children should be supervised to ensure that they do not play with the air conditioner.
- This air conditioner should be installed in accordance with AS/NZS 3000:2000 and your electricity suppliers rules.
- Abide by local council rules regarding maximum allowable noise levels emitted by air conditioners.
- If the power cord is to be replaced, replacement work must be performed by authorised personnel only.
- Installation work must be performed in accordance with the national wiring standards by authorised personnel only. Wrong connection can cause over heating or fire.

## Safety precautions

Inside you will find many helpful hints on how to use and maintain your air conditioner properly.

Just a little preventative care on your part can save you a great deal of time and money over the life of your air conditioner. You'll find many answers to common problems in the chart of troubleshooting tips. If you review the chart of Troubleshooting Tips first, you may not need to call for service.

Meanings of symbols used in this manual are shown below:

### **warning**

This symbol indicates information concerning your personal safety

### **caution**

This symbol indicates information on how to avoid damaging the appliance

### **tips and information**

This symbol indicates tips and information about use of the appliance

### **environmental tip**

This symbol indicates tips and information about economical and ecological use of the appliance























This symbol indicates never to do this



This symbol indicates always do this

### **warning**

	Do not use means to accelerate the defrosting process or to clean, other than those recommended by the manufacturer.
	Do not store the appliance in a room with continuously operating ignition sources (for example open flames, an operating electric heater or an operating gas appliance with a continuously lit pilot flame).
	Do not pierce or burn.
	Be aware that the refrigerant may be odourless.
	Connect with power properly. Otherwise, it may cause electric shock or fire due to excess heat generation.
	Do not operate or stop the unit by switching on or off the power. It may cause electric shock or fire due to heat generation.
	Do not damage or use an unspecified power cord. It may cause electric shock or fire. If the power cord is damaged, it must be replaced by the manufacturer or an authorised service centre or a similarly qualified person in order to avoid a hazard.
	Do not modify power cord length or share the outlet with other appliances. It may cause electric shock or fire due to heat generation.
	Do not operate with wet hands or in damp environment. It may cause electric shock.
	Do not direct airflow at room occupants only. This could damage your health.
	Always ensure effective earthing. No earthing may cause electric shock.
	Do not allow water to run into electric parts. It may cause failure of machine or electric shock.
	For products with a current demand of greater than 10amp always install circuit breaker and a dedicated power circuit. No installation may cause fire and electric shock.
	Disconnect the power if strange sounds, smell, or smoke comes from unit. It may cause fire and electric shock.
	Do not use the socket if it is loose or damaged. It may cause fire and electric shock.
	Do not open the unit during operation. It may cause electric shock.
	Do not use the power cord close to heating appliances. It may cause fire and electric shock.
	Do not use the power cord near flammable gas or combustibles, such as gasoline, benzene, thinner, etc. It may cause an explosion or fire.
	Ventilate room before operating air conditioner if there is a gas leakage from another appliance. It may cause explosion, fire and, burns.
	Do not disassemble or modify unit. It may cause failure and electric shock.

## Safety precautions



### caution

	<b>When the air filter is to be removed, do not touch the metal parts of the unit.</b> It may cause an injury.
	<b>Do not clean the air conditioner with water.</b> Water may enter the unit and degrade the insulation. It may cause an electric shock.
	<b>Ventilate the room well when used together with a stove, etc.</b> An oxygen shortage may occur.
	<b>Do not put a pet or house plant where it will be exposed to direct air flow.</b> This could injure the pet or plant.
	<b>Do not use for special purposes.</b> Do not use this air conditioner to preserve precision devices, food, pets, plants, and art objects. It may cause deterioration of quality, etc.
	<b>Stop operation and close the window in storm or hurricane.</b> Operation with windows opened may cause wetting of indoor and soaking of household furniture.
	<b>Hold the plug by the head of the power plug when taking it out.</b> It may cause electric shock and damage.
	<b>Turn off the main power switch when not using the unit for a long time.</b> It may cause failure of product or fire.
	<b>Do not place obstacles around air-inlets or inside of air-outlet.</b> It may cause failure of appliance or accident.
	<b>Ensure that the installation bracket of the outdoor appliance is not damaged due to prolonged exposure.</b> If bracket is damaged, there is concern of damage due to falling of unit.
	<b>Always insert the filters securely. Clean filter once every two weeks.</b> Operation without filters may cause failure.
	<b>Do not use strong detergent such as wax or thinner but use a soft cloth.</b> Appearance may be deteriorated due to change of product colour or scratching of its surface.
	<b>Do not place heavy object on the power cord and ensure that the cord is not compressed.</b> There is danger of fire or electric shock.
	<b>If water enters the unit, turn the unit off and disconnect the power, contact a qualified service technician.</b>
	<b>Use caution when unpacking and installing.</b> Sharp edges could cause injury.
	<b>Do not drink water drained from air conditioner.</b> It contains contaminants and could make you sick.

## Prior to Operation

### Preparing for operation

- 1 Contact an installation specialist for installation.
- 2 Plug in the power plug properly.
- 3 Do not use a damaged or non-standard power cord.
- 4 Do not share the same outlet with other appliances.
- 5 Do not use an extension cord.
- 6 Do not start/stop operation by plugging /unplugging the power cord.

### Usage

- 1 Exposure to direct airflow to occupants, pets or plants for an extended period of time could be hazardous to your health.
- 2 Due to the possibility of oxygen deficiency, ventilate the room when used together with stoves or other heating devices.

### Cleaning and maintenance

- 1 Do not touch the metal parts of the unit when removing the filter. Injuries can occur when handling sharp metal edges.
- 2 Do not use water to clean inside the air conditioner. Exposure to water can destroy the insulation, leading to possible electric shock.
- 3 When cleaning the unit, first make sure that the power and circuit breaker are turned off.

### Service

For repair and maintenance, contact your authorised service dealer.

## Operating temperature

### Cooling Mode

Indoor		Outdoor	
Max.	Min.	Max.	Min.
32°C	17°C	43°C	17°C

Note: Optimum performance can be achieved within these operating temperatures.

## Unit parts identification

- 1 Front panel
- 2 Air filter
- 3 Frame
- 4 Cabinet
- 5 Air inlet grille (outdoor side)
- 6 Air outlet grille
- 7 Operation knob
- 8 Power supply cord and plug

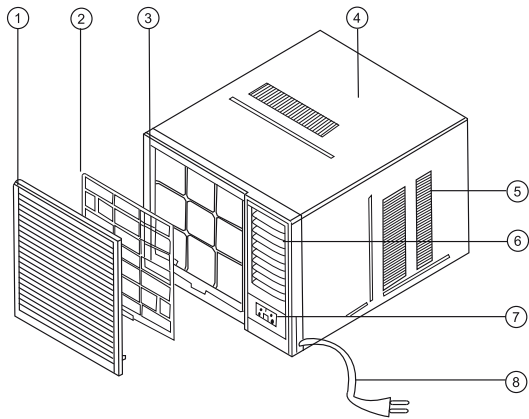

### Accessories

drain pan (optional)



screw (for fastening the front panel)



### Electrical work

Under normal circumstances there is no reason to modify the electrical connection. In case it is required, a qualified service technician should perform this task.

- 1 Power cord conductors are distinguished according to colour as follows (see Fig.1)
- 2 For your safety and protection, this unit is earthed through the power cord (see Fig.2)  
Please contact the Kelvinator Customer Care department or a qualified service agent or a similar qualified person if you want to replace it.
- 3 Be sure that the unit is correctly grounded. The wall outlet (ensure that the circuit breaker for the power outlet used for this product has suitable current rating) should be provided with reliable earth wire.

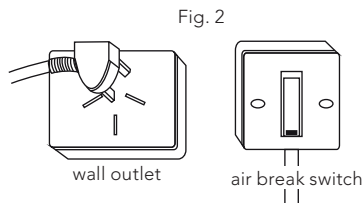
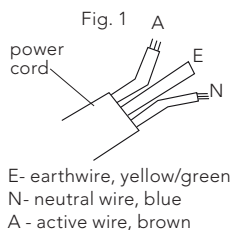

## Air conditioning features

The operation panel of your unit will look like the following:

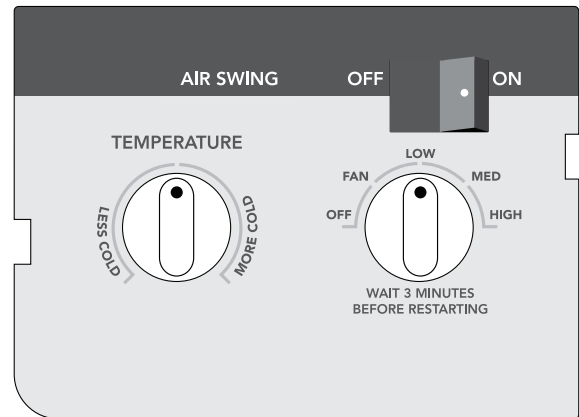

*NOTE: The outline of the operation panel is based on typical model, the function is the same with your air conditioner while some difference may exist in appearance.*

### Selector

The controls featured in this manual are representative of many available models. Your model may offer slightly different features.

### Cool Mode

The desired cool setting is selected by rotating the knob to the right to the appropriate location.

"HIGH" – has maximum cooling effect and airflow.

"LOW" – has minimum cooling effect and airflow.

"OFF" – will completely shut off the unit.

"FAN" – Permits HIGH/MED/LOW fan speed operation without cooling (heating).

*Note: When selecting a fan speed, the compressor will not run.*

## Air conditioning features

Note: When turning the SELECTOR knob from "LOW" to "HIGH", change as slowly as possible. Do not change the operation mode between "LOW", "MED" and "HIGH" too often.

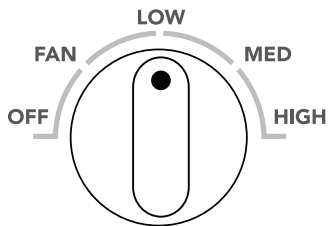

### Thermostat

To set the desired room temperature, rotate the thermostat switch to the desired setting. After the set temperature is achieved the thermostat will automatically start and stop the compressor in order to maintain the desired set temperature.

Rotate the thermostat selector clockwise for higher cool settings. Higher cool settings will provide lower room temperature. Rotate the thermostat selector counter clockwise for lower cool settings. Lower cool settings will provide higher room temperature.

The thermostat is used to set the desired room temperature when the unit is being operated in the COOL MODE.

NOTE: If the thermostat knob is set in the "more cold" section and it is then adjusted to the "less cold" section. Allow 3 minutes before readjusting back to the "more cold" section. This will allow the pressures within refrigeration system to stabilize before the compressor resumes operation.

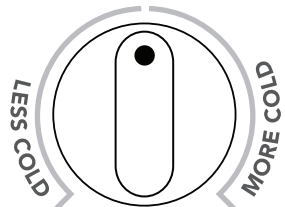

### Adjusting the air flow direction

#### Horizontal air flow adjustment

For the units with AIR SWING feature (automatic):

When the AIR SWING switch is turned to ON position, the vertical louvres automatically oscillate right and left sweeping the cold air around to obtain comfortable cooling. The vertical louvres may be stopped at any position when the AIR SWING switch is turned OFF.

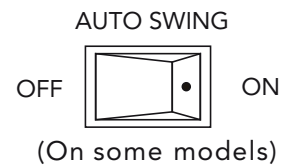
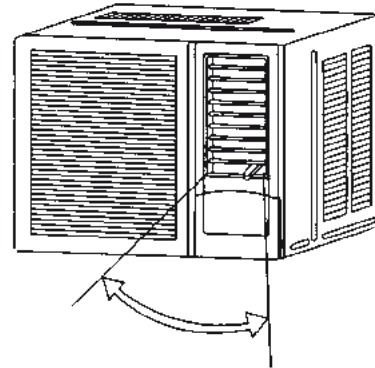

#### Horizontal air flow adjustment (manually)

To adjust horizontal air flow direction, move the lever gently to the left or right by hand until the desired horizontal air flow direction is obtained.

#### Vertical air flow adjustment (manually)

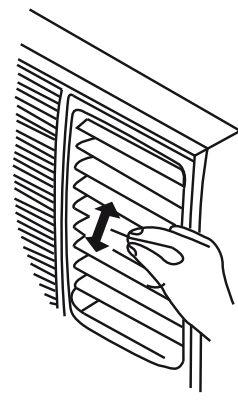

To adjust vertical air flow direction, adjust any one of the horizontal louvre blades. When turning the horizontal louvre blades up or down, always keep the top or bottom blades horizontal. This can effectively prevent water drops condensed on the front panel of the unit.

## Care and cleaning

### Vent control

The vent control is located above the control knobs. For maximum cooling efficiency, CLOSE the vent. This will allow internal air circulation. OPEN the vent to discharge stale air.

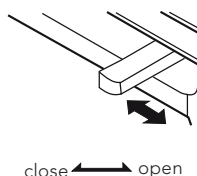

To open the vent, push the lever to the right.  
To close it, push the lever to the left.

### **caution**

Clean your air conditioner occasionally to keep it looking new. Be sure to unplug the unit before cleaning to prevent shock or fire hazards.

### Air filter cleaning

The air filter should be checked at least once a month to see if cleaning is necessary. Trapped particles in the filter can build up and cause an accumulation of frost on the cooling coils.

- Hold the slot under the front panel, then uplift it onwards, and remove the front panel.
- Pinch the handle under the air filter and make the air filter arched, remove it from the underside to upside.
- Wash the filter using liquid dishwashing detergent and warm water. Rinse filter thoroughly.
- Gently shake excess water from the filter. Be sure the filter is thoroughly dry before replacing. Or, instead of washing you may vacuum the filter clean.

*Note: Never use hot water over 40°C(104 F) to clean the air filter. Never attempt to operate the unit without the air filter.*

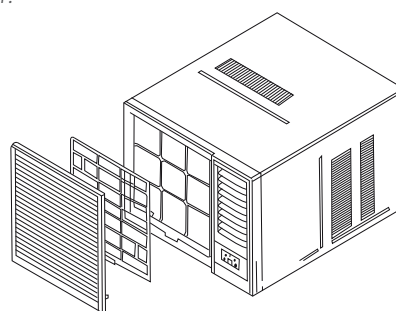

### Cabinet Cleaning

- Be sure to unplug the air conditioner to prevent shock or fire hazard. The cabinet and front may be dusted with an oil-free cloth or washed with a cloth dampened in a solution of warm water and mild liquid dishwashing detergent. Rinse thoroughly and wipe dry.
- Never use harsh cleaners, wax or polish on the cabinet front.
- Be sure to wring excess water from the cloth before wiping around the controls.
- Excess water in or around the controls may cause damage to the air conditioner.
- Plug in air conditioner.

*NOTE: Never use water over 50°C, alcohol, gasoline, acid, solvent or brush to clean the front panel as this will damage the surface of the part.*

### Winter Storage

If you plan to store the air conditioner during the winter, remove it carefully from the window according to the installation instructions. Cover it with plastic or return it to the original carton.

# Specifications

## Unit dimensions:

Model (kW)	Body dimension (mm) (WxHxD)
< 1.6kW	450x350x580

Suggest minimum wire size (AWG: American Wire Gage):

Appliance Amps	AWG Wire Size
10	18

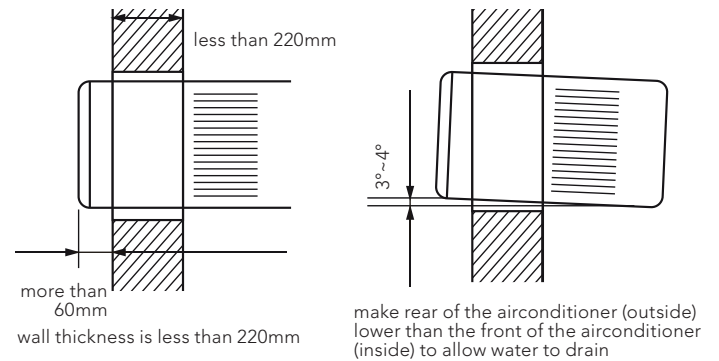

# Installation

## Select the best location

- To avoid vibration and noise, make sure the unit is installed securely and firmly.
- Install the unit where the sunlight does not shine directly on the unit.  
If the unit receives direct sunlight, build an awning to shade the cabinet.
- There should be no obstacle, such as a fence or wall, within 50cm from the back of the cabinet because it will prevent heat radiation of the condenser.  
Restriction of outside air will greatly reduce the cooling and heating efficiency of the air conditioner.
- Install the unit with rear angled down so as not to leak condensed water into the room (about 3°~4° angle with level).
- Install the unit with its bottom portion 75~150cm above the floor level.
- The power cord must be connected to an independent circuit. The yellow/green wire must be grounded.
- Based on calculations in compliance with AS60335.2.40 there is no minimum safe floor area for the installation of the air conditioners described in this manual.
- After installation the power plug should be easily accessible.
- Ensure clearance around the air conditioner meets the following:  
Minimum 150mm above the air conditioner  
Minimum 150mm on left and right side of the air conditioner  
Minimum 1,000mm in front of the air conditioner  
Minimum 500mm to rear of the air conditioner

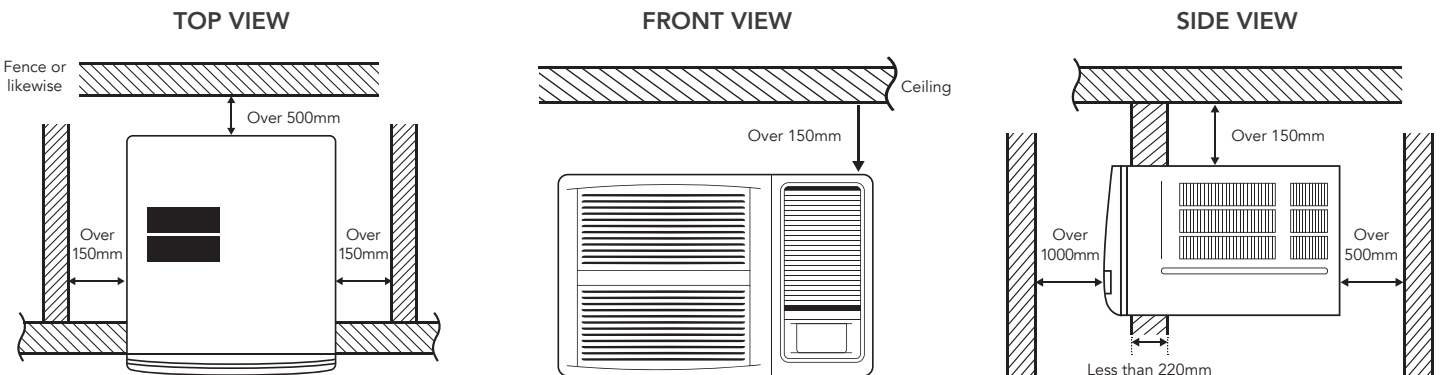
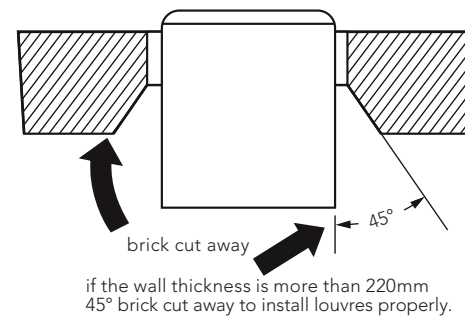
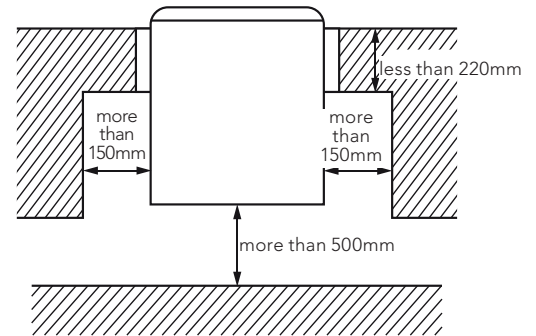

# Installation

## The treatment of condensed water

- 1 Take out the drain pan and screws (provided within your air conditioner accessories bag)
- 2 Install the drain pan at the bottom of the unit and secure it with the screws provided.
- 3 Connect a suitable sized drain hose (not supplied) to the drain outlet located on the underside of the drain pan

## Drain plug (Cooling only models)

The drain plug is fitted from the factory to capture condensed water to maximise the cooling efficiency of this product. There may be some sound of splashing water under some conditions. This configuration is used for testing the capacity and efficiency of this product for performance rating purposes.

The drain plug can be removed to drain water to a specific location and/or reduce noise but drain plug removal can reduce performance.

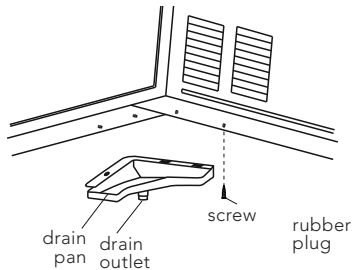

## Installation Steps

### Step 1 Remove the front panel and the air filter

- 1 Hold the slot under the front panel then lift it upwards and outwards, and remove the front panel. (see Fig.1)
- 2 Pinch the handle under the air filter and make the air filter arched, remove it from the slot from bottom to top. (see Fig.2)

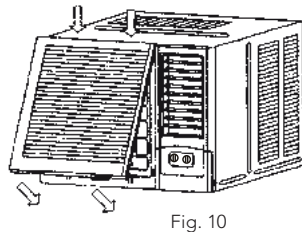
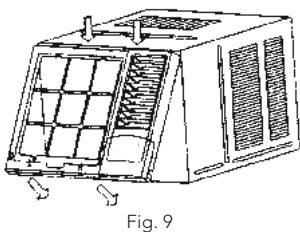
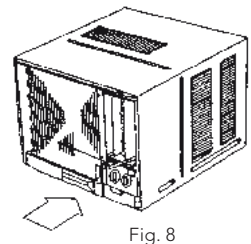
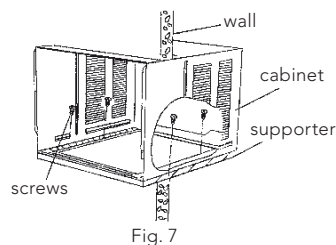
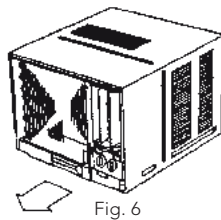
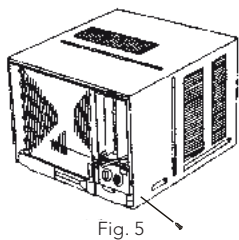
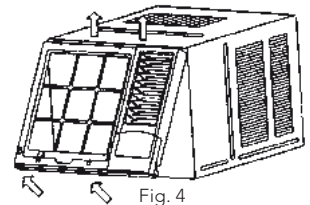
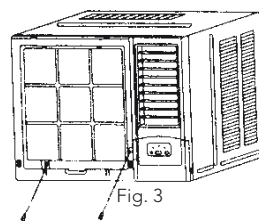
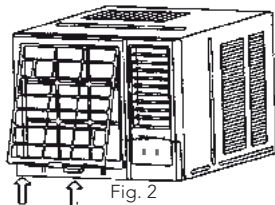
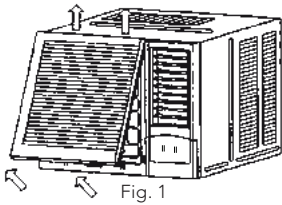

### Step 2 Removing the front panel

- 1 Remove the screws from the frame. (see Fig.3)
- 2 Grasp the left corner in the frame's underside, then loosen the frame. (see Fig.4)

### Step 3 Installation

- 1 Remove the screw, fix the chassis-fixing board and cabinet. (see Fig.5)
- 2 Grasp the handle on the chassis and carefully slide the air conditioner out of the cabinet. (see Fig.6)
- 3 When you need to drain off the water, install the drain plug on the frame. Then fix the cabinet onto the support, (provided by the installer unless you elect to install yourself) (see Fig.7).
- 4 Push the unit chassis into the cabinet. (see Fig.8)
- 5 Fix the chassis and cabinet. (see Fig.5)

### Step 4 Installing the frame

- 1 Install the frame. (see Fig.9)
- 2 Fix the screws on the frame. (see Fig.3)

### Step 5 Installing the air filter and front panel

- 1 Install the air filter into the frame's slot from top to bottom. (see Fig. 2)
- 2 Hang the front panel on the frame's buckle, then press the front panel into the frame's slot until hear a click. (see Fig.10)

## Troubleshooting tips

Before calling for service, review this list. It may save you time and money. This list includes common occurrences that are not the result of defective workman-ship or materials in this appliance.

Problem	Solution
Air conditioner does not start	Wall plug disconnected. Push plug firmly into wall outlet.
	House fuse blown or circuit breaker tripped. Replace fuse with time delay type or reset circuit breaker.
	Selector Control in OFF position. Turn selector to the desired FAN or COOL setting.
	Unit turned off by moving thermostat to a higher number and then immediately turning back to a colder number. Wait approximately 3 minutes. Listen for compressor to start.
	Unit turned off and then on too quickly. Turn unit off and wait 3 minutes before restarting.
	Thermostat set too low. Adjust thermostat to cooler setting for cooling.
Air from unit does not feel cold enough	Turn selector to a higher COOL position.
	Thermostat set too warm. Set thermostat to colder temperature.
	Room temperature below 18°C(64°F). Cooling may not occur until room temperature rises above 18°C(64°F).

Problem	Solution
Air conditioner cooling, but room is too warm- ice forming on cooling coil behind filter cover.	Outdoor temperature below 18°C(64°F). To defrost the coil, set selector to FAN position. Then, set thermostat to warmer position.
	Air filter may be dirty. Clean filter. Refer to Care and Cleaning section. To defrost, set selector to FAN.
	Thermostat set too cold for night-time cooling. To defrost the coil, set selector to a FAN position. Then, set thermostat to a warmer position.
Air conditioner cooling, but room is too warm- NO ice forming on cooling coil behind filter cover.	Dirty air filter- air restricted. Clean air filter. Refer to Care and Cleaning section.
	Thermostat set too warm. Turn thermostat clockwise to a colder setting.
	Air directional louvres positioned improperly. Position louvres for better air distribution.
	Front of units is blocked by drapes, blinds, furniture, etc. - restricts air distribution. Clear blockage in front of unit.
	Doors, windows, registers, etc. Open-cold air escapes. Close doors, windows, registers.
	Unit recently turned on in hot room. Allow additional time to remove Stored heat from walls, ceiling, floor and furniture.
Air conditioner turns on and off rapidly	Dirty air filter- air restricted. Clean air filter.
	Outside temperature extremely hot. Set to high cool to bring air past cooling coils more frequently
Noise when unit is cooling	Air movement sound. This is normal . If too loud, turn selector to lower FAN setting.
	Sound of fan hitting water-moisture removal system. This is normal when humidity is high. Close doors, windows and registers.
	Window vibration - poor installation. Refer to installation instructions or check with installer.
Water dripping INSIDE when unit is cooling.	Improper installation. Tilt air conditioner slightly to the outside to allow water drainage. Refer to installation instructions - check with installer.
Water dripping OUTSIDE when unit is cooling.	Unit removing large quantity of moisture from humid room. This is normal during excessively humid days.

# Electrolux Warranty

FOR SALES IN AUSTRALIA AND NEW ZEALAND  
KELVINATOR WINDOW/WALL AIR CONDITIONER

**This document sets out the terms and conditions of the product warranties for Kelvinator Appliances. It is an important document. Please keep it with your proof of purchase documents in a safe place for future reference should there be a manufacturing defect in your Appliance. This warranty is in addition to other rights you may have under the Australian Consumer Law.**

## 1. In this warranty:

- (a) 'ACL' or 'Australian Consumer Law' means Schedule 2 to the Competition and Consumer Act 2010;
- (b) 'Appliance' means any Electrolux product purchased by you and accompanied by this document;
- (c) 'ASC' means Electrolux's authorised serviced centres;
- (d) 'Kelvinator' is the brand controlled by Electrolux Home Products Pty Ltd of 163 O'Riordan Street, Mascot NSW 2020, ABN 51 004 762 341 in respect of Appliances purchased in Australia and Electrolux (NZ) Limited (collectively "Electrolux") of 3-5 Niall Burgess Road, Mount Wellington, in respect of Appliances purchased in New Zealand;
- (e) 'Warranty Condition' means:
  - (i) evidence by the customer that the Appliance was installed in accordance with Electrolux installation guidelines as set out in the installation manual;
  - (ii) the Appliance rating is correct for the size and thermal characteristics of the room;
  - (iii) the Appliance has been regularly maintained in accordance with Electrolux guidelines as set out in the user manual;
  - (iv) the Appliance is designed for providing human comfort and should be used under ambient conditions as set out in the product specifications and general air quality conditions.
- (f) 'Warranty Period' means the period specified in clause 3 of this warranty;
- (g) 'you' means the purchaser of the Appliance not having purchased the Appliance for re-sale, and 'your' has a corresponding meaning.

**2. Application:** This warranty only applies to new Appliances, purchased and used in Australia or New Zealand and is in addition to (and does not exclude, restrict, or modify in any way) other rights and remedies under a law to which the Appliances or services relate, including any non-excludable statutory guarantees in Australia and New Zealand.

**3. Warranty Period:** Subject to these terms and conditions, this warranty continues for in Australia for a period of 60 months and in New Zealand for a period of 60 months, following the date of original purchase of the Appliance.

**4. Repair or replace warranty:** During the Warranty Period, Electrolux or its ASC will, at no extra charge if your Appliance is readily accessible for service, without special equipment and subject to these terms and conditions, repair or replace any parts which it considers to be defective. Electrolux may, in its absolute discretion, choose whether the remedy offered for a valid warranty claim is repair or replacement. Electrolux or its ASC may use refurbished parts to repair your Appliance. You agree that any replaced Appliances or parts become the property of Electrolux.

**5. Travel and transportation costs:** Subject to clause 7, Electrolux will bear the reasonable cost of transportation, travel and delivery of the Appliance to and from Electrolux or its ASC. Travel and transportation will be arranged by Electrolux as part of any valid warranty claim.

**6. Proof of purchase** is required before you can make a claim under this warranty.

**7. Exclusions:** You may not make a claim under this warranty unless the defect claimed is due to faulty or defective parts or workmanship. This warranty does not cover:

- (a) light globes, batteries, filters or similar perishable parts;
- (b) parts and Appliances not supplied by Electrolux;
- (c) cosmetic damage which does not affect the operation of the Appliance;
- (d) damage to the Appliance caused by:
  - (i) negligence or accident;
  - (ii) misuse or abuse, including failure to properly maintain or service;
  - (iii) improper, negligent or faulty servicing or repair works done by anyone other than an Electrolux authorised repairer or ASC;
  - (iv) normal wear and tear;
  - (v) power surges, electrical storm damage or incorrect power supply;
  - (vi) incomplete or improper installation;
  - (vii) incorrect, improper or inappropriate operation;
  - (viii) insect or vermin infestation;
  - (ix) failure to comply with any additional instructions supplied with the Appliance; and
  - (x) a breach of the Warranty Conditions.

In addition, Electrolux is not liable under this warranty if:

- (a) the Appliance has been, or Electrolux reasonably believes that the Appliance has been, used for purposes other than those for which the Appliance was intended, including where the Appliance has been used for any non-domestic purpose;
- (b) the Appliance is modified without authority from Electrolux in writing;
- (c) the Appliance's serial number or warranty seal has been removed or defaced.

**8. How to claim under this warranty:** To enquire about claiming under this warranty, please follow these steps:

- (a) carefully check the operating instructions, user manual and the terms of this warranty;
- (b) have the model and serial number of the Appliance available;
- (c) have the proof of purchase (e.g. an invoice) available;
- (d) telephone the numbers shown below.

**9. Australia:** For Appliances and services provided by Electrolux in Australia: Electrolux goods come with guarantees that cannot be excluded under the Australian Consumer Law. You are entitled to a replacement or refund for a major failure and for compensation for any other reasonably foreseeable loss or damage. You are also entitled to have the Appliance repaired or replaced if the Appliance fails to be of acceptable quality and the failure does not amount to a major failure. 'Acceptable quality' and 'major failure' have the same meaning as referred to in the ACL.

**10. New Zealand:** For Appliances and services provided by Electrolux in New Zealand, the Appliances come with a guarantee by Electrolux pursuant to the provisions of the Consumer Guarantees Act, the Sale of Goods Act and the Fair Trading Act. Where the Appliance was purchased in New Zealand for commercial purposes the Consumer Guarantee Act does not apply.

**11. Confidentiality:** You accept that if you make a warranty claim, Electrolux and its agents including ASC may exchange information in relation to you to enable Electrolux to meet its obligations under this warranty.

## Important Notice

Before calling for service, please ensure that the steps listed in clause 8 above have been followed.

<b>AUSTRALIA</b>	<b>FOR SERVICE</b> or to find the address of your nearest authorised service centre in Australia <b>PLEASE CALL 13 13 49</b> <small>For the cost of a local call</small>	<b>FOR SPARE PARTS</b> or to find the address of your nearest spare parts centre in Australia <b>PLEASE CALL 13 13 50</b> <small>For the cost of a local call</small>
<b>NEW ZEALAND</b>	<b>FOR SERVICE</b> or to find the address of your nearest authorised service centre in New Zealand <b>PLEASE CALL 0800 10 66 10</b>	<b>FOR SPARE PARTS</b> or to find the address of your nearest spare parts centre in New Zealand <b>PLEASE CALL 0800 10 66 20</b>

If you'd like further information about Kelvinator appliances, please visit your retailer, phone or email our Customer Care team or visit our website.

telephone: 13 13 49

email: [customercare@electrolux.com.au](mailto:customercare@electrolux.com.au)

web: [kelvinator.com.au](http://kelvinator.com.au)

**Kelvinator. We are part of the Electrolux family.**  
Share more of our thinking at [www.electrolux.com.au](http://www.electrolux.com.au)

