



Microwave Hood Combination

Use & Care Guide

Combinación Microondas Campana

Guía de uso y cuidado

Models/Modelos 721.80802/721.80803
721.80804/721.80809

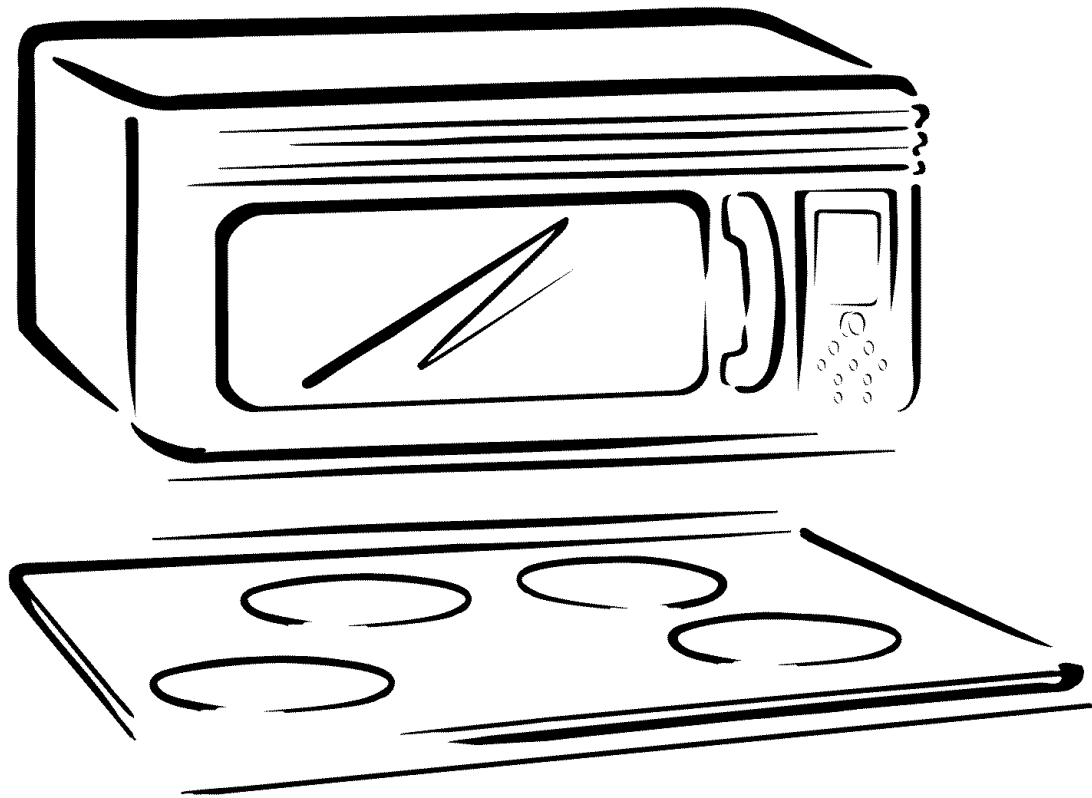

ENGLISH

ESPAÑOL

Table of Contents

Warranty	2
Sears Service	3
Microwave Oven Safety	4
Getting to Know Your Microwave Oven	7
How your kenmore microwave hood combination works	7
Radio interference	7
Testing your microwave oven	7
Testing your dinnerware or cookware	8
Operating safety precautions	8
Electrical connection	8
Microwave oven features	9
Installing glass tray	10
Oven control panel	11
Using Your Microwave Oven	13
How to use your new dial control	13
Function Selections.....	13
Clock.....	13
Kitchen Timer.....	14
Vent.....	14
Light.....	14
Add 30 second.....	14
Manual cook.....	15
Manual cook in stages	15
Cooking guide for power levels.....	16
Options.....	17
Soften & Melt	17
Child Lock	17
Favorites	18
Using Sensor Cooking.....	19
Sensor operating instructions	19
Sensor cook guide	19
Popcorn.....	19
Cook.....	20
Reheat	20
Defrost	21
Weight conversion chart	21
Defrosting tips	21
Defrost chart	22
Caring for Your Microwave Oven	24
Caring for the filters.....	25
Replacing the cooktop and oven lights	26
Microwave Cooking Tips.....	27
Questions and Answers	29
Troubleshooting.....	30
Service	Back cover

Microwave Hood Combination Warranty

FULL ONE-YEAR WARRANTY ON MICROWAVE HOOD COMBINATION

For one year from the date of purchase, if this Kenmore Microwave Hood Combination fails due to a defect in material or workmanship, Sears will repair it free of charge.

FOUR YEAR LIMITED WARRANTY ON MAGNETRON

For the second through the fifth year from the date of purchase, if the magnetron in this oven fails due to a defect in material or workmanship, Sears will supply a new magnetron, free of charge. Safety regulations, however, require the magnetron to be installed by Sears, and you must pay the labor cost of installation.

WARRANTY SERVICE IS AVAILABLE BY SIMPLY CONTACTING SEARS SERVICE AT 1-800-4-MY-HOME®

This warranty applies only while this product is in use in the United States.

This warranty gives you specific legal rights, and you may also have other rights which vary from state to state.

**Sears, Roebuck and Co.,
Dept. 817WA,
Hoffman Estates, IL 60179**

**For service call:
1-800-4-MY-HOME®
(1-800-469-4663)**

Please record your model's information.

Whenever you call to request service for your appliance, you need to know your complete model number and serial number. You can find this information on the model and serial number label/plate at the upper side of cavity front in your Microwave oven. Also, record the other information shown below.

Model Number _____
Serial Number _____
Purchase Date _____

Sears Service

Master Protection Agreements

Congratulations on making a smart purchase.

Your new Kenmore® product is designed and manufactured for years of dependable operation.

But like all products, it may require preventive maintenance or repair from time to time.

That's when having a Master Protection Agreement can save you money and aggravation.

Purchase a Master Protection Agreement now and protect yourself from unexpected hassle and expense.

The Master Protection Agreement also helps extend the life of your new product. Here's what's included in the Agreement:

- ☑ **Expert service** by our 12,000 professional repair specialists
- ☑ **Unlimited service and no charge** for parts and labor on all covered repairs
- ☑ **“No-lemon” guarantee** – replacement of your covered product if four or more product failures occur within twelve months
- ☑ **Product replacement** if your covered product can't be fixed
- ☑ **Annual Preventive Maintenance Check** at your request – no extra charge
- ☑ **Fast help by phone** – phone support from a Sears technician on products requiring in-home repair, plus convenient repair scheduling
- ☑ **Power surge protection** against electrical damage due to power fluctuations
- ☑ **Rental reimbursement** if repair of your covered product takes longer than promised

Once you purchase the Agreement, a simple phone call is all that it takes for you to schedule service. You can call anytime day or night, or schedule a service appointment online.

Sears has over 12,000 professional repair specialists, who have access to over 4.5 million quality parts and accessories. That's the kind of professionalism you can count on to help prolong the life of your new purchase for years to come. Purchase your Master Protection Agreement today!

Some limitations and exclusions apply. For prices and additional information call 1-800-827-6655.

Sears Installation Service

For Sears professional installation of home appliances, garage door openers, water heaters, and other major home items, in the U.S.A. call

1-800-4-MY-HOME®

Microwave Oven Safety

Your safety and the safety of others are very important.

We have provided many important safety messages in this manual and on your appliance. Always read and obey all safety messages.



This is the safety alert symbol.

This symbol alerts you to hazards that can kill or hurt you and others.

All safety messages will be preceded by the safety alert symbol and the word “DANGER” or “WARNING.” These words mean:

⚠ DANGER

You will be killed or seriously injured if you don't follow immediately instructions.

⚠ WARNING

You can be killed or seriously injured if you don't follow instructions.

All safety messages will identify the hazard, tell you how to reduce the chance of injury, and tell you what can happen if the instructions are not followed.

IMPORTANT SAFETY INSTRUCTIONS

When using electrical appliances basic safety precautions should be followed, including the following:

WARNING: To reduce the risk of burns, electric shock, fire, injury to persons, or exposure to excessive microwave energy:

- Read all instructions before using the microwave oven.
- Read and follow the specific “PRECAUTIONS TO AVOID POSSIBLE EXPOSURE TO EXCESSIVE MICROWAVE ENERGY” found in this section.
- The microwave oven must be grounded. Connect only to properly grounded outlet. See “GROUNDING INSTRUCTIONS” found at the end of this section.
- Install or locate the microwave oven only in accordance with the provided installation instructions.
- Some products such as whole eggs in the shell and sealed containers – for example, closed glass jars – are able to explode and should not be heated in the microwave oven.
- Use the microwave oven only for its intended use as described in this manual. Do not use corrosive chemicals or vapors in the microwave oven. This type of oven is specifically designed to heat, cook, or dry food. It is not designed for industrial or laboratory use.
- As with any appliance, close supervision is necessary when used by children.
- Do not operate the microwave oven if it has a damaged cord or plug, if it is not working properly, or if it has been damaged or dropped.

SAVE THESE INSTRUCTIONS

IMPORTANT SAFETY INSTRUCTIONS

- The microwave oven should be serviced only by qualified service personnel. Call an authorized service company for examination, repair, or adjustment.
- See door surface cleaning instructions in the “Caring for Your Microwave Oven” section.
- To reduce the risk of fire in the oven cavity:
 - Do not overcook food. Carefully attend the microwave oven when paper, plastic, or other combustible materials are placed inside the oven to facilitate cooking.
 - Remove wire twist-ties from paper or plastic bags before placing bags in oven.
 - If materials inside the oven ignite, keep oven door closed, turn oven off, and disconnect the power cord, or shut off power at the fuse or circuit breaker panel.
 - Do not use the cavity for storage purposes. Do not leave paper products, cooking utensils, or food in the cavity when not in use.
- Suitable for use above both gas and electric cooking equipment.
- Intended to be used above ranges with maximum width of 36 inches (91 cm).
- Clean Ventilating Hoods Frequently - Grease should not be allowed to accumulate on hood or filter.
- When flaming foods under the hood, turn the fan on.
- Use care when cleaning the vent-hood filter. Corrosive cleaning agents, such as lye-based oven cleaners, may damage the filter.
- Oversized foods or oversized metal utensils should not be inserted in the microwave oven as they may create a fire or risk of electric shock.
- Do not clean with metal scouring pads. Pieces can burn off the pad and touch electrical parts involving a risk of electric shock.
- Do not store anything directly on top of the microwave oven when the microwave oven is in operation.
- Do not cover or block any openings on the microwave oven.
- Do not store this microwave oven outdoors. Do not use the microwave oven near water for example, near a kitchen sink, in a wet basement, near a swimming pool, or similar location.
- Do not immerse cord or plug in water.
- Keep cord away from heated surfaces.
- Do not let cord hang over edge of table or counter.
- Do not mount over a sink.
- Do not cover racks or any other part of the oven with metal foil. This will cause overheating of the oven.
- Liquids such as water, coffee, or tea are able to be overheated beyond the boiling point without appearing to be boiling due to surface tension of the liquid. Visible bubbling or boiling when the container is removed from the microwave oven is not always present. This could result in very hot liquids suddenly boiling over when a spoon or other utensil is inserted into the liquid. To reduce the risk of injury to persons.
 - 1) Do not overheat the liquid.
 - 2) Stir the liquid both before and halfway through heating it.
 - 3) Do not use straight-sided containers with narrow necks.
 - 4) After heating, allow the container to stand in the microwave oven for a short time before removing the container.
 - 5) Use extreme care when inserting a spoon or other utensil into the container.

SAVE THESE INSTRUCTIONS

PRECAUTIONS TO AVOID POSSIBLE EXPOSURE TO EXCESSIVE MICROWAVE ENERGY

- (a) Do not attempt to operate this oven with the door open since open - door operation can result in harmful exposure to microwave energy. It is important not to defeat or tamper with the safety interlocks.
- (b) Do not place any object between the oven front face and the door or allow soil or cleaner residue to accumulate on sealing surfaces.
- (c) Do not operate the oven if it is damaged. It is particularly important that the oven door close properly and that there is no damage to the:
 - (1) Door (bent),
 - (2) Hinges and latches (broken or loosened),
 - (3) Door seals and sealing surfaces.
- (d) The oven should not be adjusted or repaired by anyone except properly qualified service personnel.

Electrical requirements

Observe all governing codes and ordinances. A 120 Volt, 60 Hz, AC only, 20 amp fused electrical supply is required. (A time-delay fuse is recommended.) It is recommended that a separate circuit serving only this appliance be provided.

DANGER



Electrical Shock Hazard
 Plug into a grounded 3-prong outlet. Do not remove ground prong. Do not use an adapter. Do not use an extension cord. Failure to follow these instructions can result in death, fire, or electrical shock.

GROUNDING INSTRUCTIONS

• For all cord connected appliances:
 The microwave oven must be grounded. In the event of an electrical short circuit, grounding reduces the risk of electric shock by providing an escape wire for the electric current. The microwave oven is equipped with a cord having a grounding wire with a grounding plug. The plug must be plugged into an outlet that is properly installed and grounded.

WARNING: Improper use of the grounding can result in a risk of electric shock.

Consult a qualified electrician or serviceman if the grounding instructions are not completely understood, or if doubt exists as to whether the microwave oven is properly grounded.

Do not use an extension cord. If the power supply cord is too short, have a qualified electrician or serviceman install an outlet near the microwave oven.

• For a permanently connected appliance:
 The microwave oven must be connected to a grounded, metallic, permanent wiring system, or an equipment grounding conductor should be run with the circuit conductors and connected to the equipment grounding terminal or lead on the microwave oven.

SAVE THESE INSTRUCTIONS

Getting to Know Your Microwave Oven

This section discusses the concepts behind microwave cooking. It also shows you the basics you need to know to operate your microwave oven. Please read this information before you use your oven.

HOW YOUR KENMORE MICROWAVE HOOD COMBINATION WORKS

Microwave energy is not hot. It causes food to make its own heat, and it's this heat that cooks the food. Microwaves are like TV waves, radio waves, or light waves. You cannot see them, but you can see what they do.

A **magnetron** in the microwave oven produces microwaves. The microwaves move into the oven where they contact food as it turns on the turntable.

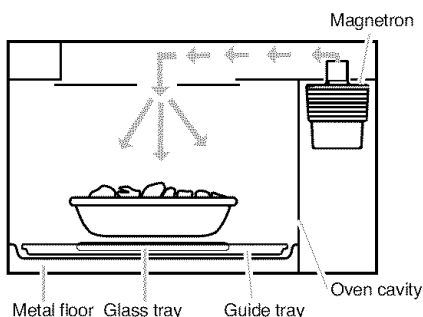

The **glass turntable** of your microwave oven lets microwaves pass through. Then they bounce off a metal floor, back through the glass turntable, and are absorbed by the food.

Microwaves pass through most glass, paper, and plastics without heating them so food absorbs the energy. Microwaves bounce off metal containers so food does not absorb the energy.

Sensor Cooking

The Microwave System features Sensor Cooking functions. A humidity sensor in the oven cavity detects moisture and humidity emitted from food as it heats. The sensor adjusts cooking times to various types and amounts of food. Sensor cooking takes the guesswork out of microwave cooking.

For the best cooking results

- **Always cook food** for the shortest cooking time recommended. Check to see how the food is cooking.
- **Stir, turn over, or rearrange** the food being cooked about halfway through the cooking time for all recipes. This will help make sure the food is evenly cooked.
- **If you do not have a cover for a dish**, use wax paper, or microwave-approved paper towels or plastic wrap. Remember to turn back a corner of the plastic wrap to vent steam during cooking.

Radio interference

Using your microwave oven may cause interference to your radio, TV, or similar equipment. When there is interference, you can reduce it or remove it by:

- **Cleaning** the door and sealing surfaces of the oven.
- **Adjusting** the receiving antenna of the radio or television.

- **Moving** the receiver away from the microwave oven.
- **Plugging** the microwave oven into a different outlet so that the microwave oven and receiver are on different branch circuits.

Testing your microwave oven

To test the oven put about 1 cup of cold water in a glass container in the oven. Close the door.

Make sure it latches. Cook at 100% power for 1 minute. When the time is up, the water should be heated.

Testing your dinnerware or cookware

Test dinnerware or cookware before using. To test a dish for safe use, put it into the oven with a cup of water beside it. Cook at 100% cook power for one minute. **If the dish gets hot, do not use it.** Some dishes (melamine, some ceramic dinnerware, etc.) absorb microwave energy,

becoming too hot to handle and slowing cooking times. Cooking in metal containers not designed for microwave use could damage the oven, as could containers with hidden metal (twist-ties, foil lining, staples, metallic glaze or trim).

Operating safety precautions

- **Never** lean on the door or allow a child to swing on it when the door is open.
- **Use hot pads.** Microwave energy does not heat containers, but the heat from the food can make the container hot.
- **Do not** use newspaper or other printed paper in the oven.
- **Do not** dry flowers, fruit, herbs, wood, paper, gourds, or clothes in the oven.
- **Do not** start a microwave oven when it is empty. Product life may be shortened. If you practice programming the oven, **put** a container of water in the oven. It is normal for the oven door to look wavy after the oven has been running for a while.
- **Do not** try to melt paraffin wax in the oven. Paraffin wax will not melt in a microwave oven because it allows microwaves to pass through it.
- **Do not** operate the microwave oven unless the glass turntable is securely in place and can move freely. The turntable can move in either direction. **Make sure** the turntable is correct-side up in the oven. **Handle your turntable with care** when removing it from the oven to avoid possibly breaking it. If your turntable cracks or breaks, contact your dealer for a replacement.
- **When you use a browning dish**, the browning dish bottom must be at least 3/16 inch above the turntable. Follow the directions supplied with the browning dish.
- **Never cook or reheat a whole egg inside the**

shell. Steam buildup in whole eggs may cause them to burst, and possibly damage the oven.

Slice hard-boiled eggs before heating. In rare cases, poached eggs have been known to explode. **Cover** poached eggs and **allow** a standing time of one minute before cutting into them.

- **For best results, stir any liquid several times during heating or reheating.** Liquids heated in certain containers (especially containers shaped like cylinders) may become overheated. The liquid may splash out with a loud noise during or after heating or when adding ingredients (coffee granules, tea bags, etc.). This can harm the oven.
- **Microwaves** may not reach the center of a roast. The heat spreads to the center from the outer, cooked areas just as in regular oven cooking. This is one of the reasons for letting some foods (for example, roasts or baked potatoes) stand for a while after cooking, or for stirring some foods during the cooking time.
- **Do not deep fry in the oven.** Microwavable utensils are not suitable and it is difficult to maintain appropriate deep-frying temperatures.
- **Do not overcook potatoes.** At the end of the recommended cooking time, potatoes should be slightly firm because they will continue cooking during standing time. **After microwaving, let** potatoes stand for 5 minutes. They will finish cooking while standing.

Electrical connection

If your electric power line or outlet voltage is less than 110 volts, cooking times may be longer.

Have a qualified electrician check your electrical system.

Microwave oven features

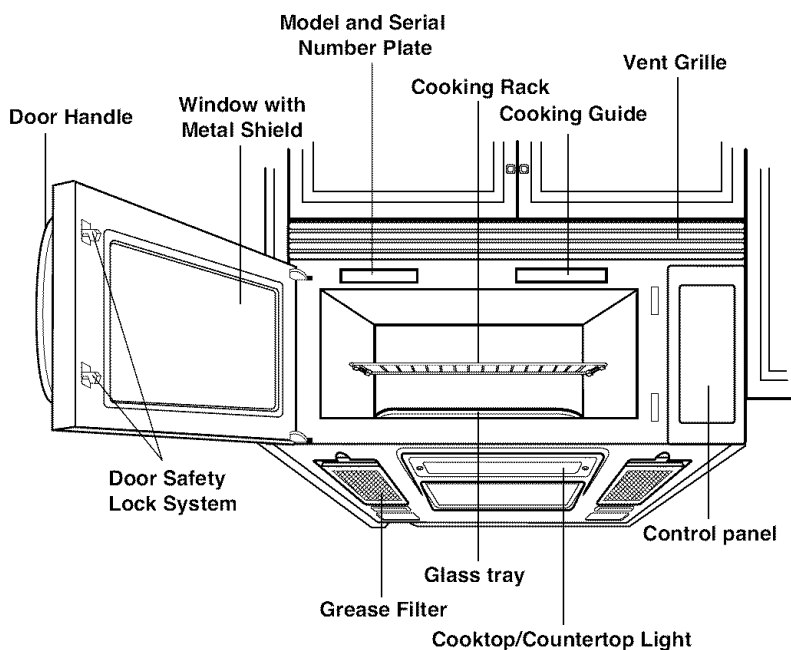

Your microwave oven is designed to make your cooking experience as enjoyable and productive as possible. To get you up and running quickly, the following is a list of the oven's basic features:

1. **Metal Shielded Window.** The shield prevents microwaves from escaping. It is designed as a screen to allow you to view food as it cooks.
2. **Model and Serial Number Plate & Cooking Guide Label**
3. **Charcoal Filter** (behind Vent Grille)
4. **Vent Grille**
5. **Glass tray.** The glass tray moves food as it cooks for more even cooking. It must be in the oven during operation for best cooking results.
6. **Cooktop Light**
7. **Grease Filter.** See "Caring for the filters" section.
8. **Control Panel.** Touch the pads on this panel to perform all functions.
9. **Cooking Rack.** Use for extra space when cooking in more than one container at the same time.

Installing glass tray

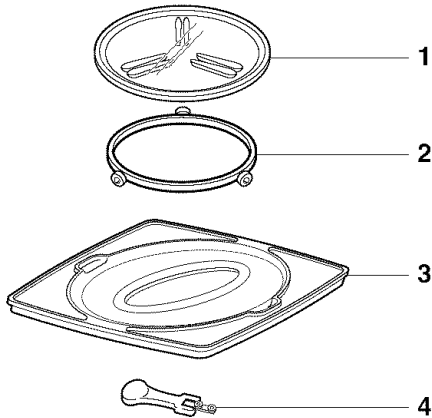

- 1. Glass tray
- 2. Rotating ring
- 3. Guide tray
- 4. Shaft

The glass tray moves in both direction and turns to help cook food more evenly. Do not operate the microwave oven without the glass tray in place.

To Install:

1. Place the guide tray on the oven cavity bottom.
The rollers on the shaft should fit inside the guide tray bottom groove.(see figure 1,2)
2. Place the rotating ring on the guide tray.
(see figure 3)
3. Place the glass tray on the rotating ring. Fit the rollers of the shaft between the raised, hollowed groove of the glass tray bottom. The rollers on the rotating ring should fit inside the glass tray bottom ridge.(see figure 4,5)

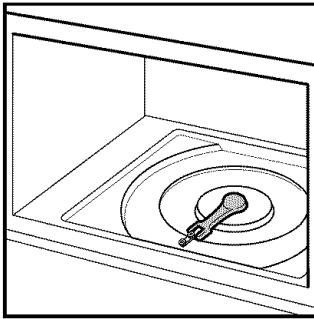

Figure 1

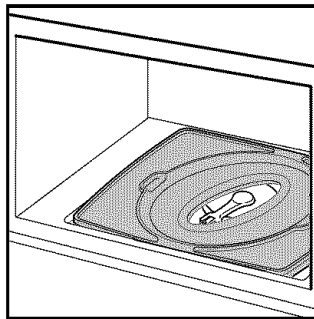

Figure 2

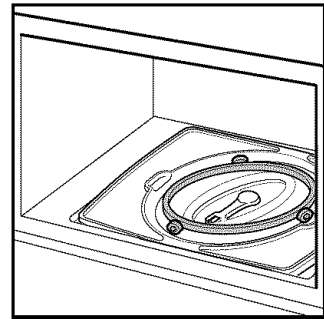

Figure 3

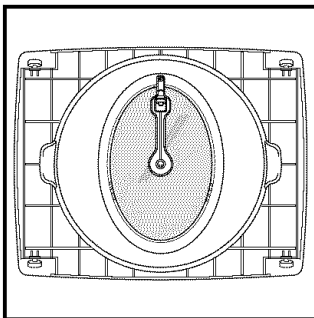

Figure 4

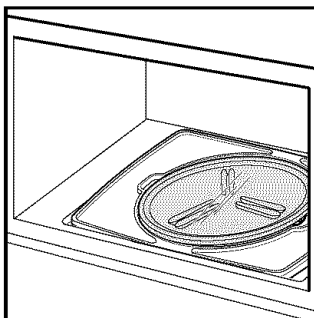
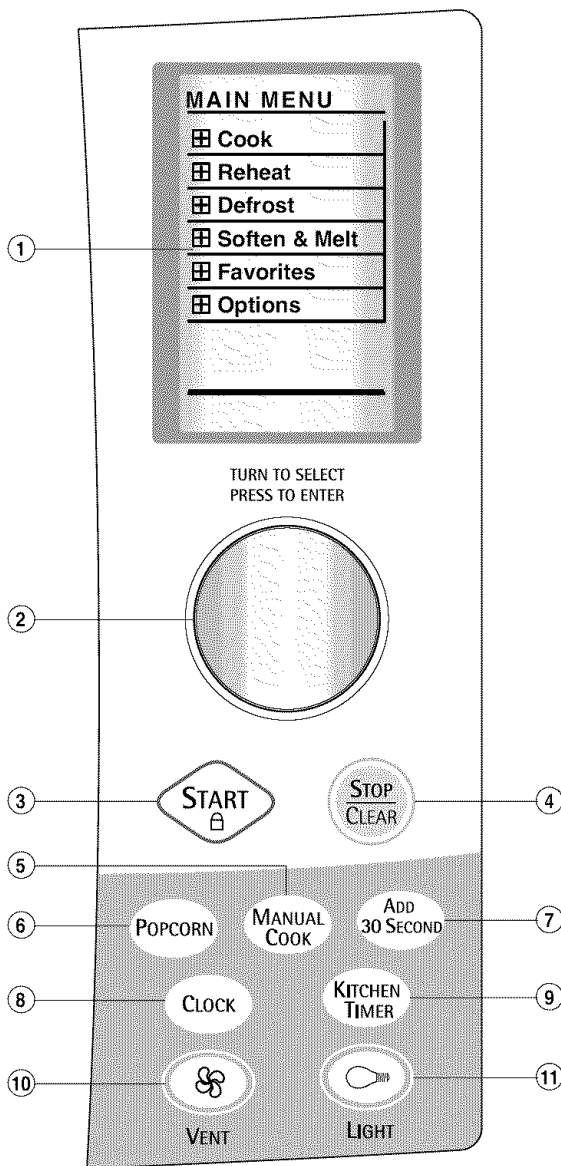

Figure 5

Oven control panel

ENGLISH



- 1. Display Screen** shows the time of day and Cook Mode when the microwave oven is not in use. During programming, it displays function menus for you to choose from, servings and weights for you to enter, preparation instructions, and cooking time/power settings for you to select. During a cooking cycle, it counts down the remaining time and prompts you to stir, turn food, etc., as necessary.
- 2. Touch DIAL Control.** Use this dial to select oven functions, such as quantities of food and cooking times/powers. (See page 13.)
- 3. START.** Touch this pad to start a function. If you open the door after the oven begins to cook, retouch start.
- 4. STOP/CLEAR.** Touch this pad to stop and cancel any oven function.
- 5. MANUAL COOK.** Touch this pad for manual control of cook time and power level. The Stop/Clear pad can also be used to cancel. (See pages 15 and 16.)
- 6. POPCORN.** Touch this pad to pop popcorn with the sensor feature. The oven's sensor will tell the oven how long to cook depending on the amount of humidity it detects from the popcorn.. (See page 19)
- 7. ADD 30 SECOND.** Touch this pad to cook for 30 seconds at 100% cook power, or to add extra seconds at the set cook power to your cooking cycle. (See page 14)
- 8. CLOCK.** Touch this pad to enter the time of day. (See page 13)
- 9. KITCHEN TIMER.** Touch this pad to set the Kitchen Timer.(See page 14)
- 10. VENT.** Touch this pad to display the hood vent fan speed settings. Turn dial to set the fan speed and Press. (See page 14.)
- 11 LIGHT.** Touch this pad to display the dark and bright settings. (See page 14.)

Using Your Microwave Oven

HOW TO USE YOUR NEW DIAL CONTROL

Faster, easier, better than ever before--
Just watch the display screen and choose what you want from the menus.

Touch Stop/Clear

- To stop any microwave function.

Turn DIAL control to:

- Select a function.
- Set cook time and power.
- Set clock/Kitchen Timer.
- Set vent fan speed.
- Set the brightness of Light.

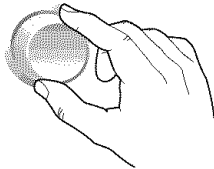

Press DIAL control to:

- Enter a selection.
- To start cooking.

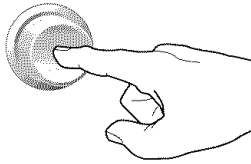

FUNCTION SELECTIONS

Cook

- Potatoes
- Fresh Vegetables
- Canned Vegetables
- Frozen Vegetables
- Microwave Pizza
- Frozen Entree
- Rice & Pasta
- Casserole
- Meat
- Poultry
- Fish & Seafood
- Eggs

Reheat

- Dinner Plate
- Soup & Sauce
- Casserole
- Pizza Reheat
- Beverage

Defrost

- Ground Meat
- Poultry
- Fish
- Bread

Soften & Melt

- Melt
- Soften

Favorites

- Edit Menu

Options

- Auto Night Light
- Child Lock
- Sound
- Contrast
- Scroll Speed
- Power Save
- Reminder

Tips

- Cleaning
- Power
- Food
- Techniques
- Utensils
- Learning/Demo mode

CLOCK

Example: To set 8:00 PM. JUL 05, 2004

Touch:

1.  Touch the **Clock** pad.

Display Shows:

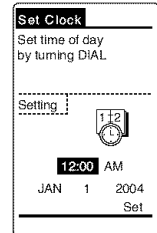

2.  Set time of day by turning Dial and press.

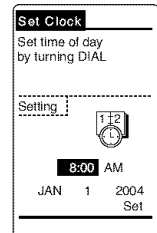

3.  Turn dial to select **PM** and press.

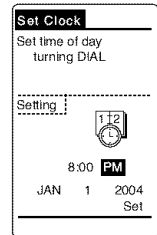

4.  Turn dial to select **JUL** and press.

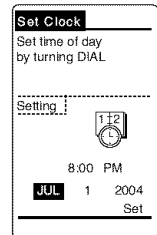

5.  Turn dial to select **5** and press.

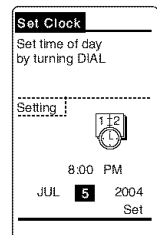

6.  Turn dial to select **2004** and press.

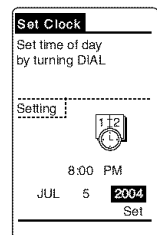

KITCHEN TIMER

Your microwave oven can be used as a kitchen timer. You can set up to 99 minutes, 99 seconds.

Example : To set Kitchen Timer (3 minutes).

Touch:

Display Shows:

1.  Press **KITCHEN TIMER** pad.

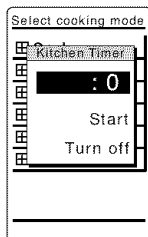

2.  Press **Set**.

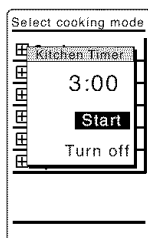

3.  Turn dial to enter time and press.

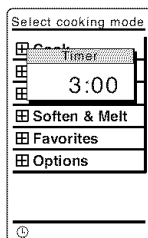

NOTE: Press Kitchen Timer pad, Turn dial to select Turn off and press to cancel Kitchen Timer.

LIGHT

Touch:

Display Shows:

1.  Touch the **LIGHT** pad.

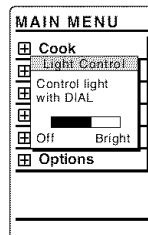

2.  Turn dial to choose brightness from **Dark** to **Bright** light and press.

ADD 30 SECOND

A time-saving pad, this simplified control lets you quickly set and start microwave cooking.

Example : To set for 2 minutes.

Touch:

Display Shows:

1.  Touch **ADD 30 SECOND** pad four times. The oven begins cooking and display shows time counting down.

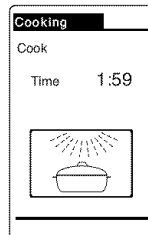

NOTE: Each press of **ADD 30 SECOND** will add 30 seconds, up to 99 minutes.

VENT

The **VENT** removes steam and other vapors from the cooking surface.

Touch:

Display Shows:

1.  Touch the **VENT** pad.

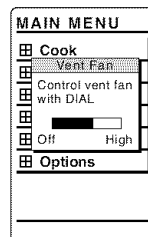

2.  Turn dial to choose fan speed from **Slow** to **Fast** speed and press.

NOTE: If the temperature gets too hot around the microwave oven, the fan in the vent hood will automatically turn on at the low setting to cool the oven. It may stay on up to an hour to cool the oven. When this occurs, **You can not turn the vent fan off.**

MANUAL COOK

Example : To cook food for 8 minutes 30 seconds at 70% power.

Touch:

Display Shows:

1.



Press **MANUAL COOK** pad.

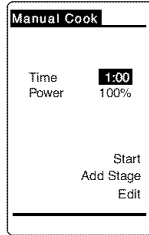

2.

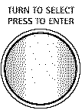

Turn dial to enter Time, Power and press.

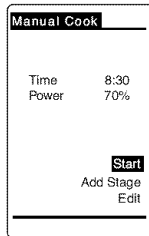

3.



Press **Start**.

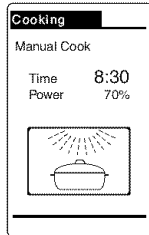

NOTE: Turn dial to select Edit to modify the setting.

MANUAL COOK in stages

Example : To cook food for 3 minutes at 100% power (first stage), 7 minutes 30 seconds at 70% power (second stage), 1 minute at 10% power (third stage)

Touch:

Display Shows:

1.



Press **MANUAL COOK** pad.

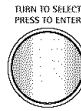

Turn dial to enter Time, Power of first stage and press.

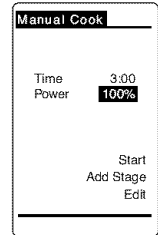

3.



Press **Add Stage**.

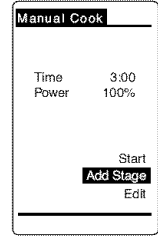

4.



Turn dial to enter Time, Power of 2nd, 3rd stages, and press.

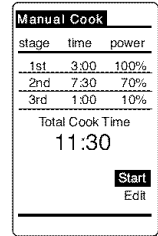

5.



Press **Start**.

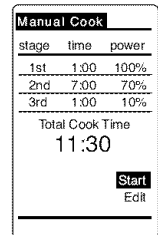

NOTE: Turn dial to select Edit to modify the stages.

COOKING GUIDE FOR POWER LEVELS

The nine power levels in addition to HIGH allow you to choose the best power level for the food you are cooking. Below are listed all the power levels, examples of foods

best cooked at each level, and the amount of microwave power you are using.

POWER LEVEL	MICROWAVE OUTPUT	USE
10 (HIGH)	100%	<ul style="list-style-type: none"> • Boil water. • Cook ground beef. • Make candy. • Cook fresh fruits and vegetables. • Cook fish and poultry. • Preheat browning dish.
9	90%	<ul style="list-style-type: none"> • Reheat meat slices quickly. • Sauté onions, celery, and green pepper.
8	80%	<ul style="list-style-type: none"> • All reheating. • Cook scrambled eggs.
7	70%	<ul style="list-style-type: none"> • Cook breads and cereal products. • Cook cheese dishes, veal. • Cook cakes, muffins, brownies, cupcakes.
6	60%	<ul style="list-style-type: none"> • Cook pasta.
5	50%	<ul style="list-style-type: none"> • Cook meats, whole poultry. • Cook custard. • Cook whole chicken, turkey, spare ribs, rib roast, sirloin roast.
4	40%	<ul style="list-style-type: none"> • Cook less tender cuts of meat. • Reheat frozen convenience foods.
3	30%	<ul style="list-style-type: none"> • Thawing meat, poultry, and seafood. • Cooking small quantities of food. • Finish cooking casserole, stew, and some sauces.
2	20%	<ul style="list-style-type: none"> • Soften butter and cream cheese. • Heating small amounts of food.
1	10%	<ul style="list-style-type: none"> • Soften ice cream. • Raise yeast dough.
0		<ul style="list-style-type: none"> • Standing time.

OPTIONS

You can change the default values for Child Lock, Sound, Contrast, Scroll Speed, and Power Save.

FUNCTION	REMARK
AUTO NIGHT LIGHT	set auto night light time
CHILD LOCK	child lock/unlock
SOUND	beep control
CONTRAST	adjust contrast to desired level
SCROLL SPEED	adjust scroll speed to desired level
POWER SAVE	select display lamp's on/off
REMINDER	set reminder time

SOFTEN & MELT

The oven uses low power to melt or to soften foods.

Example : To melt 2 sticks of butter.

Touch:

Display Shows:

- TURN TO SELECT PRESS TO ENTER



Touch dial to select **SOFTEN & MELT** and press.

Press dial to select

 - ☐ Cook
 - ☐ Reheat
 - ☐ Defrost
 - ☑ **Soften & Melt**
 - ☐ Favorites
 - ☐ Options
- TURN TO SELECT PRESS TO ENTER



Turn dial to select **SOFTEN** and press.

Press dial to select

 - ☐ Defrost
 - ☐ Soften & Melt
 - ☑ **Soften**
 - ☐ Favorites
 - ☐ Options
- TURN TO SELECT PRESS TO ENTER



Turn dial to select **BUTTER** and press.

Press dial to select

 - ☐ Soften & Melt
 - ☐ Melt
 - ☐ Soften
 - ☑ **Butter**
 - Ice Cream
 - Cream Cheese
 - Frozen Juice
- TURN TO SELECT PRESS TO ENTER



Turn dial to enter the sticks. Turn dial to select **START** and press.

Sticks range is 1-3

 - ☐ Soften & Melt
 - ☐ Soften
 - Butter

2 Sticks
Start
Preparation
Go Back

CHILD LOCK

You may lock the control panel to prevent the microwave from being accidentally started or used by children.

Example : To set the child lock.

Touch:

Display Shows:

- TURN TO SELECT PRESS TO ENTER



Turn dial to select **Options** and press.

Press dial to select

 - ☐ Cook
 - ☐ Reheat
 - ☐ Defrost
 - ☐ Soften & Melt
 - ☐ Favorites
 - ☑ **Options**
- TURN TO SELECT PRESS TO ENTER



Turn dial to select **Child Lock** and press.

Press dial to select

 - ☐ Options
 - ☑ **Child Lock**
 - Auto night light
 - Sound
 - Contrast
 - Power Save
 - Scroll Speed
 - Reminder
 - ☐ Tips
- TURN TO SELECT PRESS TO ENTER



Turn dial to select **Yes** and press.

Child Lock

Do you want to lock oven controls?

Setting: 

No **Yes**

Example: To unlock child lock.

Press and hold **START** pad down for 3 seconds to unlock the controls.

Child Lock

Press & hold START pad down for 3 seconds to unlock the controls



FAVORITES

FAVORITES lets you recall one cooking instruction previously placed in memory and begin cooking quickly.

Example : To Edit Menu (reheat a piece of pizza for 30 seconds)

Touch:

Display Shows:

1.  Turn dial to select **Favorites** and press.

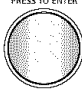
Press dial to select
 Cook
 Reheat
 Defrost
 Soften & Melt
Favorites
 Options
2.  Turn dial to select **Edit Menu** and press.

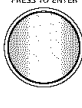
Press dial to select
 Cook
 Reheat
 Defrost
 Soften & Melt
 Favorites
Edit Menu
 Options
3.  Turn dial to select **New item** and press.

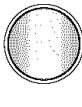
Press dial to select
New Item
 No custom menu
4.  Enter the Menu (Turn dial to select the Alphabet and press) and press **Name** **Ok**.

Input Cook Name
 Pizza
 Time 00:00
 Power 100%
 ABCDEFGHIJKLM
 NOPQRSTUVWXYZ
 0 1 2 3 4 5 6 7 8 9
 Back Space
Name Ok

5.



Turn dial to enter the time and power. Turn dial to select **Complet** and press.

Set Time/Power
 Pizza
 Time **1:00**
 Power 100%
 Complet
 Add Stage

Set Time/Power
 Pizza
 Time **:30**
 Power 100%
 Complet
 Add Stage

Set Time/Power
 Pizza
 Time :30
 Power 100%
Complet
 Add Stage

Example : To recall memorized Menu(Pizza)

Touch:

Display Shows:

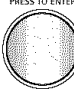
1.  Turn dial to select **Favorites** and press.

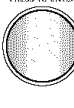
Press dial to select
 Cook
 Reheat
 Defrost
 Soften & Melt
Favorites
 Edit Menu
 Pizza
 Options
2.  Turn dial to select **Pizza** and press.

Press dial to select
 Cook
 Reheat
 Defrost
 Soften & Melt
 Favorites
 Edit Menu
Pizza
 Options

Using Sensor cooking

SENSOR OPERATING INSTRUCTIONS

Sensor Cook allows you to cook most of your favorite foods without selecting cooking times and power levels. The display will indicate Sensing during the initial sensing period. The oven automatically determines required cooking time for each food item. When the internal sensor detects a certain amount of humidity coming from the food, it will tell the oven how much longer to heat. The display will show the remaining heating time. For best results for cooking by Sensor, follow these recommendations.

1. Food cooked with the sensor system should be at normal storage temperature.
2. Glass Tray (TURNTABLE) and outside of container should be dry to assure best cooking results.
3. Foods should always be covered with microwavable plastic wrap, waxed paper, or a lid.
4. Do not open the door or touch the **STOP/CLEAR** key during the sensing time. When sensing time is over, the oven beeps and the remaining cooking time will appear in the display window. At this time you can open the door to stir, turn, or rearrange the food.

SENSOR COOK GUIDE

Appropriate containers and coverings help assure good Sensor cooking results.

1. Always use microwavable containers and cover them with lids or plastic wrap.
2. Never use tight-sealing plastic covers. They can prevent steam from escaping and cause food to overcook.
3. Match the amount of the size of the container. Fill containers at least half full for best results.
4. Be sure the outside of the cooking container and the inside of the microwave oven are dry before placing food in the oven. Beads of moisture turning into steam can mislead the sensor.

POPCORN

Popcorn lets you pop popcorn without needing to program times and power.

Example : To pop popcorn.

Touch:

Display Shows:

1.  POPCORN

Touch the **Popcorn** pad.

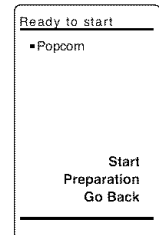

2.  TURN TO SELECT
PRESS TO ENTER

If you already know how to prepare food, **turn** dial to select **Start** and press. (See 'Preparation' note below)

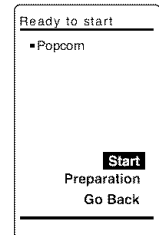

3. Wait for tones that signal the end of cooking time.

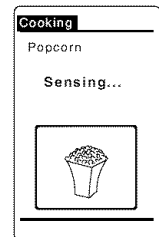

NOTE: Selecting 'Preparation' will provide helpful hints preparing this type of food.

COOK

Using **Cook** lets you heat common microwave-prepared foods without needing to program times and power.

Example : To pop popcorn.

Touch:

Display Shows:

1.

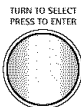

Turn dial to select **Cook** and press.



2.

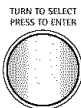

Turn dial to select **Potatoes** and press.

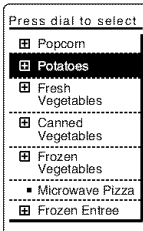

3.

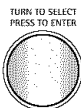

Turn dial to select **White** and press.

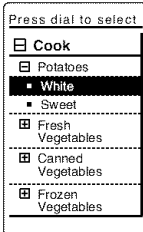

4.

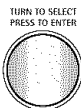

If you already know how to prepare food, **turn** dial to select **Start** and press.

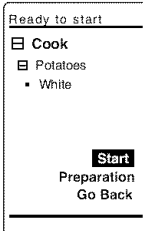

5.

Wait for tones that signal the end of cooking time.

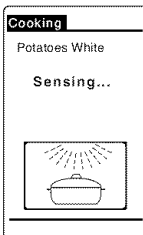

REHEAT

Reheat lets you heat foods without needing to program times and power.

Example : To reheat dinner plate.

Touch:

Display Shows:

1.

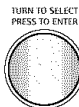

Turn dial to select **Reheat** and press.

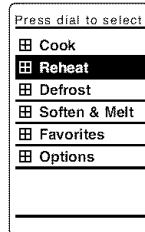

2.

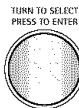

Turn dial to select **Dinner Plate** and press.

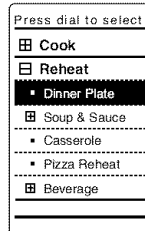

3.

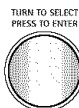

Turn dial to select **Start** and press.

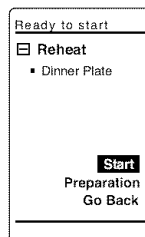

4.

Wait for tones that signal the end of cooking time.

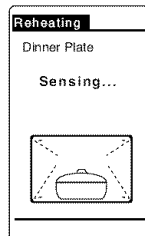

DEFROST

Your microwave oven is preset with four defrost categories. Using **Defrost** is the best way to defrost frozen foods.

Example: To defrost 1.2 lbs. of ground beef.

Touch:

Display Shows:

1.



Turn dial to select **Defrost** and press.

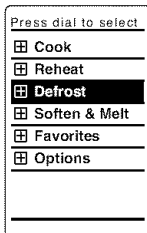

2.

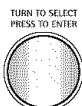

Turn dial to select **Ground Meat** and press.

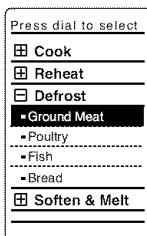

3.

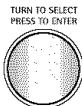

Turn dial to enter the **weight** and press.

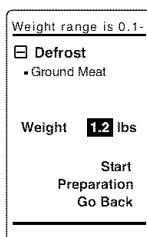

4.



Turn dial to select **Start** and press.

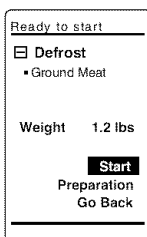

5.

Wait for tones that signal the end of cooking time.

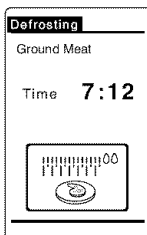

WEIGHT CONVERSION CHART

To enter food weight in DEFROST, you must specify pounds and tenths of a pound. If the weight on the food package is in fractions of a pound, you can use the following chart to convert the weight to decimals.

EQUIVALENT OUNCE WEIGHT	NUMBER AFTER DECIMAL	
1.6	.10	
3.2	.20	
4.0	.25	One-Quarter Pound
4.8	.30	
6.4	.40	
8.0	.50	One- Half Pound
9.6	.60	
11.2	.70	
12.0	.75	Three-Quarters Pound
12.8	.80	
14.4	.90	
16.0	1.00	One Pound

DEFROSTING TIPS

- **When using DEFROST**, the weight to be entered is the net weight in pounds and tenths of pounds (the weight of the food minus the container.)
- **Use DEFROST** only for raw food. DEFROST gives best results when food to be thawed is a minimum of 0°F (taken directly from a true freezer). If food has been stored in a refrigerator-freezer that does not maintain a temperature of 5°F or below, always program a lower food weight (for a shorter defrosting time.) to prevent cooking the food.
- **If the food is stored outside** the freezer for up to 20 minutes, enter a lower food weight.
- **The shape of the package** alters the defrosting time. Shallow rectangular packets defrost more quickly than a deep block.
- **Separate pieces** as they begin to defrost. Separated pieces defrost more easily.
- **You can use small pieces** of aluminum foil to shield foods like chicken wings, leg tips, and fish tails, but the foil must not touch the side of the oven. Foil causes arcing, which can damage the oven lining.
- **Shield areas of food** with small pieces of foil if they start to become warm.
- **For better results, a preset standing time** is included in the defrosting time.

DEFROST CHART

Meat setting

FOOD	SETTING	AT BEEP	SPECIAL INSTRUCTIONS
BEEF			Meat of irregular shape and large, fatty cuts of meat should have the narrow or fatty areas shielded with foil at the beginning of a defrost sequence.
Ground Beef, Bulk	MEAT	Remove thawed portions with fork. Turn over. Return remainder to oven.	Do not defrost less than 1/4 lb. Freeze in doughnut shape.
Ground Beef, Patties	MEAT	Separate and rearrange.	Do not defrost patties weighing less than two ounces each. Depress center when freezing.
Round Steak	MEAT	Turn over. Cover warm areas with aluminum foil.	Place on the defrosting rack.
Tenderloin Steak	MEAT	Turn over. Cover warm areas with aluminum foil.	Place on the defrosting rack.
Stew Beef	MEAT	Remove thawed portions with fork. Separate remainder. Return remainder to oven.	Place in a microwavable dish and put on the defrosting rack.
Pot Roast, Chuck Roast	MEAT	Turn over. Cover warm areas with aluminum foil.	Place on the defrosting rack.
Rib Roast	MEAT	Turn over. Cover warm areas with aluminum foil.	Place on the defrosting rack.
Rolled Rump Roast	MEAT	Turn over. Cover warm areas with aluminum foil.	Place on the defrosting rack.
LAMB			
Cubes for Stew	MEAT	Remove thawed portions with fork. Return remainder to oven.	Place on a microwavable dish and put on the defrosting rack.
Chops (1 inch thick)	MEAT	Separate and rearrange.	Place on the defrosting rack.
PORK			
Chops (1/2 inch thick)	MEAT	Separate and rearrange.	Place on the defrosting rack.
Hot Dogs	MEAT	Separate and rearrange.	Place on the defrosting rack.
Spareribs Country-style Ribs	MEAT	Turn over. Cover warm areas with aluminum foil.	Place on the defrosting rack.
Sausage, Links	MEAT	Separate and rearrange.	Place on the defrosting rack.
Sausage, Bulk	MEAT	Remove thawed portions with fork. Turn over. Return remainder to oven.	Place on the defrosting rack.
Loin Roast, Boneless	MEAT	Turn over. Cover warm areas with aluminum foil.	Place on the defrosting rack.

DEFROST CHART (CONTINUED)

Poultry setting

FOOD	SETTING	AT BEEP	SPECIAL INSTRUCTIONS
CHICKEN Whole (up to 6 lbs) Cut-up	POULTRY	Turn over (finish defrosting breast-side down.) Cover warm areas with aluminum foil. Separate pieces and rearrange. Turn over. Cover warm areas with aluminum foil.	Place chicken breast-side up on the defrosting rack. Finish defrosting by immersing in cold water. Remove giblets when chicken is partially defrosted. Place in a microwavable dish and put on the defrosting rack. Finish defrosting by immersing in cold water.
CORNISH HENS Whole	POULTRY	Turn over. Cover warm areas with aluminum foil.	Place on the defrosting rack. Finish defrosting by immersing in cold water.
TURKEY Breast (under 6 lbs)	POULTRY	Turn over. Cover warm areas with aluminum foil.	Place in a microwavable dish and put on the defrosting rack. Finish defrosting by immersing in cold water.

Fish setting

FOOD	SETTING	AT BEEP	SPECIAL INSTRUCTIONS
FISH Fillets Steaks Whole	FISH FISH FISH	Turn over. Separate fillets when partially thawed if possible. Separate and rearrange. Turn over.	Place in a microwavable dish and put on the defrosting rack. Carefully separate fillets under cold water. Place in a microwavable dish and put on the defrosting rack. Run cold water over to finish defrosting. Place on the defrosting rack. Cover head and tail with foil; do not let foil touch sides of microwave . Finish defrosting by immersing in cold water.
SHELLFISH Crabmeat Lobster tails Shrimp Scallops	FISH FISH FISH FISH	Break apart. Turn over. Turn over and rearrange. Separate and rearrange. Separate and rearrange.	Place in a microwavable dish and put on the defrosting rack. Place in a microwavable dish and put on the defrosting rack. Place in a microwavable dish and put on the defrosting rack. Place in a microwavable dish and put on the defrosting rack.

NOTE : *Available weight is 0.1~6.0 lbs (0.1~4.0 Kg).

Caring for Your Microwave Oven

To make sure your microwave oven looks good and works well for a long time, you should maintain it properly. For proper care, please follow these instructions carefully.

For interior surfaces: Wash often with warm, sudsy water and a sponge or soft cloth. **Use** only mild, nonabrasive soaps or a mild detergent. **Be sure to keep the areas clean where the door and oven frame touch when closed.** Wipe well with clean cloth.

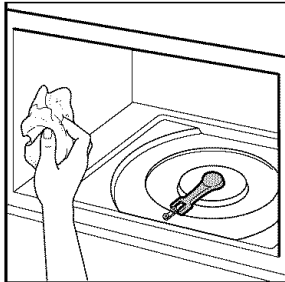

Over time, stains can occur on the surfaces as the result of food particles spattering during cooking. This is normal.

For stubborn soil, boil a cup of water in the oven for 2 to 3 minutes. Steam will soften the soil. To get rid of odors inside the oven, boil a cup of water with some lemon juice or vinegar in it.

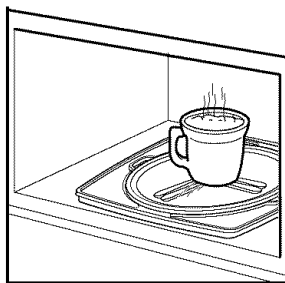

For exterior surfaces and control panel: Use a soft cloth with spray glass cleaner. Apply the spray glass cleaner to the soft cloth; do not spray directly on the oven.

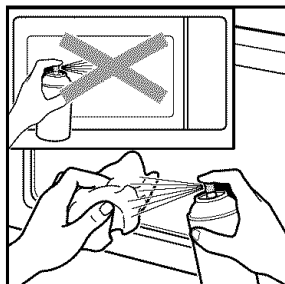

NOTE: Abrasive cleansers, steel wool pads, gritty wash cloths, some paper towels, etc., can

damage the control panel and the interior and exterior oven surfaces.

To clean glass tray, Rotating ring and Guide tray,

Glass tray



Rotating ring



Guide tray



wash in mild, sudsy water; for heavily soiled areas **use** a mild cleanser and scouring sponge. To clean glass tray, Rotating ring and Guide tray are dishwasher safe.

CARING FOR THE FILTERS

The grease filters should be removed and cleaned often, at least once a month.

NOTE: If your microwave hood combination is installed to recirculate air, the charcoal filter (Part No. 5230W1A003A) is available from Sears by calling 1-800-4-MY-HOME®.

The charcoal filter cannot be cleaned and should be replaced every 6 to 12 months.

Grease filters (Part No. 2B72705B):

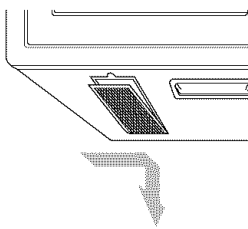

1. Unplug microwave oven or disconnect power.

2. To remove grease filters, slide each filter to the side. Pull filters downward and push to the other side. The filter will drop out.

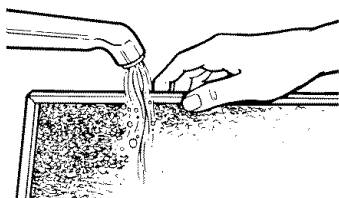

3. Soak grease filters in hot water and a mild detergent. Scrub and swish to remove embedded dirt and grease. Rinse well and shake to dry. Do not clean filters with ammonia, corrosive cleaning agents such as lye-based oven cleaners, or place them in a dishwasher. The filters will turn black or could be damaged.

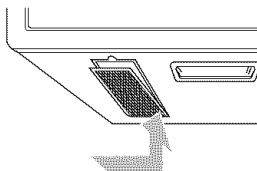

4. To replace grease filters, slide filter in the frame slot on one side of the opening. Push filter upward and push to the other side to lock into place.

5. Plug in microwave oven or reconnect power.

CHARCOAL FILTER REPLACEMENT

If your oven is vented inside, the charcoal filter should be replaced every 6 to 12 months, and more often if necessary. The charcoal filter cannot be cleaned. To order a new charcoal filter, contact the Parts Department at your nearest Authorized Service Center.

1. **Disconnect** power or **unplug** microwave oven.
2. **Remove** the two vent grille mounting screws.

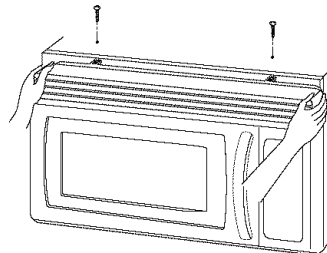

3. **Tip** the grille forward, then lift out to remove.
4. Remove old filter.

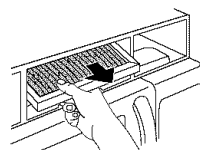

5. **Slide** a new charcoal filter into place. The filter should rest at the angle shown.

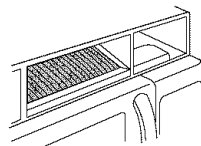

6. **Slide** the bottom of the vent grille into place. **Push** the top until it snaps into place. **Replace** the mounting screws.
7. **Reconnect** power or **plug** in microwave oven.

REPLACING THE COOKTOP AND OVEN LIGHTS

The cooktop light

1. Unplug microwave oven or disconnect power.

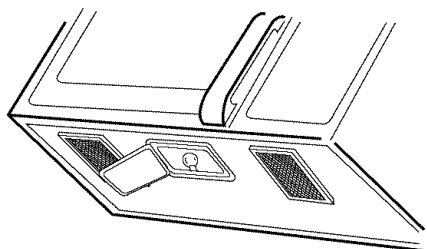

2. Remove the bulb cover mounting screws.

3. Replace bulb with 20-watt bulb.

4. Plug in microwave oven or reconnect power.

4. Remove bulb holder.

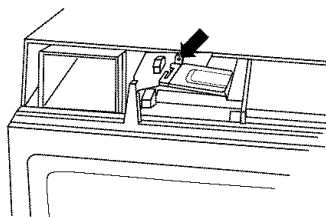

5. Lift up the bulb holder.

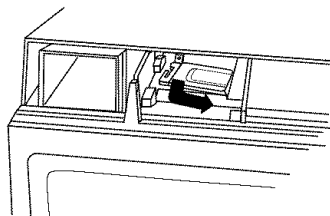

6. Replace the bulb with a 20-watt bulb.

The oven light

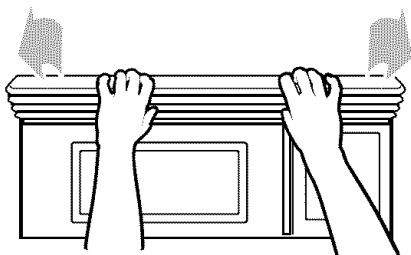

1. Unplug microwave oven or disconnect power.

2. Remove the vent grille mounting screws.

3. Tip the grille forward, then lift out to remove.

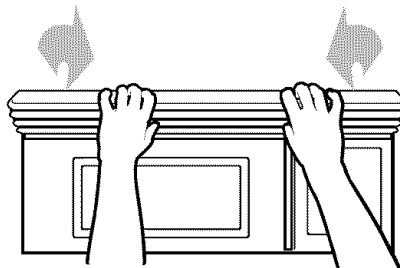

7. Slide the top of the vent grille into place. Push the bottom until it snaps into place. Replace the mounting screws.

8. Plug in microwave oven or reconnect power.

MICROWAVE COOKING TIPS

Amount of food

- **If you increase or decrease** the amount of food you prepare, the time it takes to cook that food will also change. For example, if you double a recipe, add a little more than half the original cooking time. Check for doneness and, if necessary, add more time in small increments.

Starting temperature of food

- **The lower the temperature** of the food being put into the microwave oven, the longer it takes to cook. Food at room temperature will be re-heated more quickly than food at refrigerator temperature.

Composition of food

- **Food with a lot of fat and sugar** will be heated faster than food containing a lot of water. Fat and sugar will also reach a higher temperature than water in the cooking process.
- **The more dense the food**, the longer it takes to heat. “Very dense” food like meat takes longer to heat than lighter, more porous food like sponge cakes.

Size and shape

- **Smaller pieces of food** will cook faster than larger pieces. Also, same-shaped pieces cook more evenly than different-shaped pieces.
- **With foods that have different thicknesses**, the thinner parts will cook faster than the thicker parts. **Place** the thinner parts of chicken wings and legs in the center of the dish.

Stirring, turning foods

- **Stirring and turning foods** spreads heat quickly to the center of the dish and avoids overcooking at the outer edges of the food.

Covering food

Cover food to:

- **Reduce** splattering
- **Shorten** cooking times
- **Keep** food moist

You can use any covering that lets microwaves pass through. See “Getting to Know Your Microwave Oven” for materials that microwaves will pass through. If you are using the Sensor function, be sure to vent.

Releasing pressure in foods

- **Several foods** (for example: baked potatoes, sausages, egg yolks, and some fruits) are tightly covered by a skin or membrane. Steam can build up under the membrane during cooking, causing the food to burst. To relieve the pressure and to prevent bursting, **pierce** these foods before cooking with a fork, cocktail pick, or toothpick.

Using standing time

- **Always allow food to stand** after cooking. Standing time after defrosting and cooking allows the temperature to evenly spread throughout the food, improving the cooking results.
- **The length of the standing time** depends on how much food you are cooking and how dense it is. Sometimes it can be as short as the time it takes you to remove the food from the oven and take it to the serving table. However, with larger, denser food, the standing time may be as long as 10 minutes.

Arranging food

For best results, place food evenly on the plate. You can do this in several ways:

- **If you are cooking several items of the same food**, such as baked potatoes, **place** them in a ring pattern for uniform cooking.
- **When cooking foods of uneven shapes or thickness, such as chicken breasts, place** the smaller or thinner area of the food towards the center of the dish where it will be heated last.
- **Layer thin slices of meat** on top of each other.
- **When you cook or reheat whole fish, score** the skin – this prevents cracking.
- **Do not** let food or a container touch the top or sides of the oven. This will prevent possible arcing.

Using aluminum foil

Metal containers should not be used in a microwave oven. There are, however, some exceptions. If you have purchased food which is prepackaged in an aluminum foil container, refer to the instructions on the package. When using aluminum foil containers, cooking times may be longer because microwaves will only penetrate the top of the food. If you use aluminum containers without package instructions, follow these guidelines:

MICROWAVE COOKING TIPS (CONT.)

Using aluminum foil (cont.)

- **Place** the container in a glass bowl and add some water so that it covers the bottom of the container, not more than 1/4 in. (.64 cm) high. This ensures even heating of the container bottom.
- **Always remove** the lid to avoid damage to the oven.
- **Use only** undamaged containers.
- **Do not use** containers taller than 3/4 in. (1.9 cm).
- **Container must be** at least half filled.
- **To avoid arcing**, there must be a minimum 1/4 in. (.64 cm) between the aluminum container and the walls of the oven and also between two aluminum containers.
- **Always place** the container on the turntable.
- **Shield** with small pieces of aluminum foil, parts of food that may cook quickly, such as wing tips and leg ends of poultry.
- **Heating food** in aluminum foil containers usually takes up to double the time compared to reheating in plastic, glass, china, or paper containers. The time when food is ready will vary depending upon the type of container you use.
- **Let food stand** for 2 to 3 minutes after heating so that heat is spread evenly throughout container.

Cooking you should not do in your microwave oven

- **Do not** do canning of foods in the oven. Closed glass jars may explode, resulting in damage to the oven.
- **Do not** use the microwave oven to sterilize objects (baby bottles, etc.). It is difficult to keep the oven at the high temperature needed for sterilization.

Removing the rack

- When popping commercially packaged popcorn, **Remove the rack from the oven**; Do not place the bag of microwave popcorn on the rack or under the rack.
- In the case of popping microwave popcorn with rack, that can cause the fire or damage to your microwave oven.

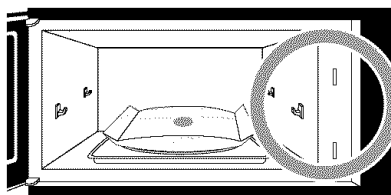
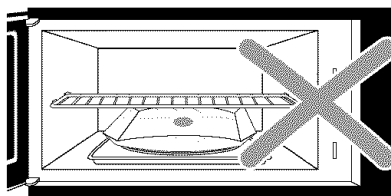
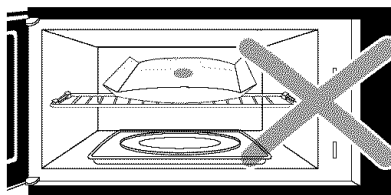

Questions and Answers

QUESTIONS	ANSWERS
Can I operate my microwave oven without the glass tray or move the glass tray over to hold a large dish?	No. If you remove or move the glass tray, you will get poor cooking results. Dishes used in your oven must fit on the glass tray.
Can I use either metal or aluminum pans in my microwave oven?	You can use aluminum foil for shielding (use small, flat pieces), small skewers, and shallow foil trays (if tray is not taller than 3/4 in. [1.9 cm] deep and is filled with food to absorb microwave energy). Never allow metal to touch walls or door.
Is it normal for the glass tray to move in either direction?	Yes. The glass tray moves from side to side, depending on the rotation of the motor when the cooking cycle begins.
Sometimes the door of my microwave oven appears wavy. Is this normal?	This appearance is normal and does not affect the operation of your oven.
Why does the dish become hot when I microwave food in it? I thought that this should not happen.	As the food becomes hot it will conduct the heat to the dish. Be prepared to use hot pads to remove food after cooking.
What does "standing time" mean?	"Standing time" means that food should be removed from the oven and covered for additional time to allow it to finish cooking. This frees the oven for other cooking.
Why does steam come out of the air exhaust vent?	Steam is normally produced during cooking. The microwave oven has been designed to vent this steam out the vents.
Can I pop popcorn in my microwave oven? How do I get the best results?	Yes. Pop packaged microwave popcorn following manufacturer's guidelines. Do not use regular paper bags. Do not repop unpopped kernels. Do not pop popcorn in glass cookware.

Troubleshooting

Most cooking problems often are caused by little things you can find and fix without tools of any kind. Check the lists below and on the next page before calling for assistance or service. If you still need help, call Sears Service at 1-800-4-MY-HOME®.

MICROWAVE OVEN DOES NOT WORK

PROBLEM	CAUSE
Nothing works.	<ul style="list-style-type: none">• The power supply cord is not plugged into a grounded 3 prong outlet. (See the "Electrical Requirements" section on page 6 and the "Electrical connection" section on Page 8.)• A household fuse has blown or a circuit breaker has tripped.• The electric company has had a power failure.
The microwave oven will not run.	<ul style="list-style-type: none">• You are using the as a timer. Press Kitchen Timer pad, turn dial to select Turn off and press to cancel Kitchen Timer.• The door is not firmly closed and latched.• You did not touch START.• You did not follow directions exactly.• An operation that you set earlier is still running. Touch STOP/CLEAR to cancel that operation.

COOKING TIMES

PROBLEM	CAUSE
Food is not cooked enough.	<ul style="list-style-type: none">• The electric supply to your home or wall outlets is low or lower than normal. Your electric company can tell you if the line voltage is low. Your electrician or service technician can tell you if the outlet voltage is low.• The cook power is not at the recommended setting. Check the chart on Page 16.
The display shows a time counting down but the oven is not cooking.	<ul style="list-style-type: none">• The oven door is not closed completely.• You have set the controls as a kitchen timer. Press Kitchen Timer pad, turn dial to select Turn off and press to cancel Kitchen Timer.

GLASS TRAY

PROBLEM	CAUSE
The glass tray will not move.	<ul style="list-style-type: none"> • The glass tray is not correctly in place. It should be correct-side up and sitting firmly on the center hub. • The support is not operating correctly. Remove the glass tray and restart the oven. If the hub still does not move, call Sears Service at 1-800-4-MY-HOME®. Cooking without the glass tray can give you poor results.

TONES

PROBLEM	CAUSE
You do not hear the programming or end-of-cycle tone.	<ul style="list-style-type: none"> • You have not entered the correct command.

DISPLAY MESSAGES

PROBLEM	CAUSE
The display is flashing “ : . ”	<ul style="list-style-type: none"> • There has been a power interruption. Reset the clock. (See the “Clock” section on Page 13.)

If none of these items are causing your problem, call Sears Service at 1-800-4-MY-HOME®.