

Karinear



CERAMIC HOB

Instruction Manual / Installation Manual

30cm Ceramic Hob	
KNC-D11047	KNC-D21858-UL
KNC-D22058-UL	KNC-D21858-UL-LH06
KNC-D22058-UL-LH06	KNC-D21858-UL-LH07
KNC-D22058-UL-LH07	KNC-D21858-UL-LH09
KNC-D22058-UL-LH09	KNC-D21829-UL
KNC-D22029-UL	KNC-D22058-MG-UL-208
KNC-D22058-MG-UL-226	KNC-D22058-MG-UL-W

IMPORTANT SAFEGUARDS

When using electrical appliances, basic safety precautions should always be followed including the following:

1. Read all instructions.
2. Do not touch hot surfaces. Use handles or knobs.
3. To protect against electrical shock do not immerse cord, plugs, or appliance in water or other liquid.
4. Close supervision is necessary when any appliance is used by or near children.
5. Unplug from outlet when not in use and before cleaning. Allow to cool before putting on or taking off parts.
6. Do not operate any appliance with a damaged cord or plug or after the appliance malfunctions or has been damaged in any manner. Return appliance to the nearest authorized service facility for examination, repair, or adjustment.
7. The use of accessory attachments not recommended by the appliance manufacturer may cause injuries.
8. Do not use outdoors.
9. Do not let cord hang over edge of table or counter, or touch hot surfaces.
10. Do not place on or near a hot gas or electric burner, or in a heated oven.
11. Extreme caution must be used when moving an appliance containing hot oil or other hot liquids.
12. Always attach plug to appliance first, then plug cord into the wall outlet. To disconnect, turn any control to "off", then remove plug from wall outlet.
13. Do not use appliance for other than intended use.
14. Do Not Cook on Broken Cook-Top – If cook-top should break, cleaning solutions and spillovers may penetrate the broken cook-top and create a risk of electric shock.
15. Clean Cook-Top with Caution – If a wet sponge or cloth is used to wipe spills on a hot cooking area, be careful to avoid steam burn, some cleaners can produce noxious fumes if applied to a hot surface.
16. A short power-supply cord is provided to reduce risks resulting from becoming entangled in or tripping over a longer cord. Longer extension cords are available and may be used if care is exercised in their use.
If a long extension cord is used:
 - a) The marked electrical rating of the extension cord should be at least as great as the electrical rating of the appliance;
 - b) The cord should be arranged so that it will not drape over the countertop or tabletop where it can be pulled on by children or tripped over unintentionally; and
 - c) If the appliance is of the grounded type, the cord set or extension cord should be a grounding-type 3-wire cord.
17. 60 MINUTES "ON" IN A TWO HOUR PERIOD
18. After three hours of continuous operation, the appliance will automatically shut down and the indicator will flash.

Save these Instructions.

SAFETY WARNINGS

Your safety is important to us. Please read this information before using your cooktop.

INSTALLATION

II Electrical Shock Hazard

- Disconnect the appliance from the mains electricity supply before carrying out any work or maintenance on it.
- Connection to a good system is essential and mandatory.
- Alterations to the domestic wiring system must only be made by a qualified electrician.
- Failure to follow this advice may result in electrical shock or death.

II Cut Hazard

- Take care - panel edges are sharp.
- Failure to use caution could result in injury or cuts.

II Important safety instructions

- Read these instructions carefully before installing or using this appliance.
- No combustible material or products should be placed on this appliance at any time.
- Please make this information available to the person responsible for installing the appliance as it could reduce your installation costs.
- In order to avoid a hazard, this appliance must be installed according to these instructions for installation.
- This appliance is to be properly installed and without earthed only by a suitably qualified person.
- This appliance should be connected to a circuit which incorporates an isolating switch providing full disconnection from the power supply.
- Failure to install the appliance correctly could invalidate any warranty or liability claims.

OPERATION AND MAINTENANCE

II Electrical Shock Hazard

- Do not cook on a broken or cracked cooktop. If the cooktop surface

should break or crack, switch the appliance off immediately at the mains power supply (wall switch) and contact a qualified technician.

- Switch the cooktop off at the wall before cleaning or maintenance.
- Failure to follow this advice may result in electrical shock or death.
- Any other servicing should be performed by an authorized service representative.

II Health Hazard

- This appliance complies with electromagnetic safety standards.

II Hot Surface Hazard

- During use, accessible parts of this appliance will become hot enough to cause burns.
- Do not let your body, clothing or any item other than suitable cookware contact the ceramic glass until the surface is cool.
- Beware: magnetisable metal objects worn on the body may become hot in the vicinity of the cooktop.
- Keep children away.
- Handles of saucepans may be hot to touch. Check saucepan handles do not overhang other cooking zones that are on. Keep handles out of reach of children.
- Failure to follow this advice could result in burns and scalds.

II Cut Hazard

- The razor-sharp blade of a cooktop scraper is exposed when the safety cover is retracted. Use with extreme care and always store safely and out of reach of children.
- Failure to use caution could result in injury or cuts.

II Important safety instructions

- Read these instructions carefully before installing or using this appliance.
- No combustible material or products should be placed on this appliance at any time.
- Please make this information available to the person responsible for installing the appliance as it could reduce your installation costs.
- In order to avoid a hazard, this appliance must be installed according to these instructions for installation.
- This appliance is to be properly installed and earthed only by a suitably

qualified person.

- This appliance should be connected to a circuit which incorporates an isolating switch providing full disconnection from the power supply.
- Failure to install the appliance correctly could invalidate any warranty or liability claims.

II Electrical Shock Hazard

- Do not cook on a broken or cracked cooktop. If the cooktop surface should break or crack, switch the appliance off immediately at the mains power supply (wall switch) and contact a qualified technician.
- Switch the cooktop off at the wall before cleaning or maintenance.
- Failure to follow this advice may result in electrical shock or death.

II Health Hazard

- This appliance complies with electromagnetic safety standards.

II Hot Surface Hazard

- During use, accessible parts of this appliance will become hot enough to cause burns.
- Do not let your body, clothing or any item other than suitable cookware contact the ceramic glass until the surface is cool.
- Metallic objects such as knives, forks, spoons and lids should not be placed on the hob surface since they can get hot
- Keep children away.
- Handles of saucepans may be hot to touch. Check saucepan handles do not overhang other cooking zones that are on. Keep handles out of reach of children.
- Failure to follow this advice could result in burns and scalds.

II Cut Hazard

- The razor-sharp blade of a cooktop scraper is exposed when the safety cover is retracted. Use with extreme care and always store safely and out of reach of children.
- Failure to use caution could result in injury or cuts.

II Important safety instructions

- Never leave the appliance unattended when in use. Boilover causes smoking and greasy spillovers that may ignite.
- Never use your appliance as a work or storage surface.
- Never leave any objects or utensils on the appliance.
- Never use your appliance for warming or heating the room.
- After use, always turn off the cooking zones and the cooktop as described in this manual (i.e. by using the touch controls).

- Do not allow children to play with the appliance or sit, stand, or climb on it.
- Do not store items of interest to children in cabinets above the appliance. Children climbing on the cooktop could be seriously injured.
- Do not leave children alone or unattended in the area where the appliance is in use.
- Children or persons with a disability which limits their ability to use the appliance should have a responsible and competent person to instruct them in its use. The instructor should be satisfied that they can use the appliance without danger to themselves or their surroundings.
- Do not repair or replace any part of the appliance unless specifically recommended in the manual. All other servicing should be done by a qualified technician.
- Do not use a steam cleaner to clean your cooktop.
- Do not place or drop heavy objects on your cooktop.
- Do not stand on your cooktop.
- Do not use pans with jagged edges or drag pans across the glass surface as this can scratch the glass.
- Do not use scourers or any other harsh abrasive cleaning agents to clean your cooktop, as these can scratch the glass.
- If the supply cord is damaged, it must be replaced by the manufacturer, its service agent or similarly qualified persons in order to avoid a hazard.
- This appliance is intended to be used in household and similar applications such as: -staff kitchen areas in shops, offices and other working environments; -farm houses; -by clients in hotels, motels and other residential type environments ; -bed and breakfast type environments.
- **WARNING: The appliance and its accessible parts become hot during use.**

Care should be taken to avoid touching heating elements.

Children less than 8 years of age shall be kept away unless continuously supervised.

- This appliance can be used by children aged from 8 years and above and persons with reduced physical, sensory or mental capabilities or lack of experience and knowledge if they have been given supervision or instruction concerning use of the appliance in a safe way and understand the hazards involved.
- Children shall not play with the appliance. Cleaning and user maintenance shall not be made by children without supervision.
- **WARNING: Unattended cooking on a hob with fat or oil can be dangerous and may result in fire. NEVER try to extinguish a fire with water, but switch off the appliance and then cover flame e.g. with a lid or a fire blanket.**
- **WARNING: Danger of fire: do not store items on the cooking surfaces.**
- **Warning: If the surface is cracked, switch off the appliance to avoid the possibility of electric shock for hob surfaces of glass-ceramic or similar material which protect live parts**
- A steam cleaner is not to be used.
- The appliance is not intended to be operated by means of an external timer or separate remote-control system.

INTRODUCTION

on the purchase of your new Ceramic Hob.

We recommend that you spend some time to read this Instruction / Installation Manual in order to fully understand how to install correctly and operate it.

For installation, please read the installation section.

Read all the safety instructions carefully before use and keep this Instruction / Installation Manual for future reference.

PRODUCT OVERVIEW

II Top View

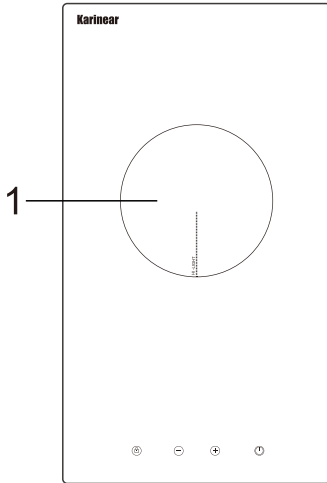

KNC-D11047
1.165mm/1100W

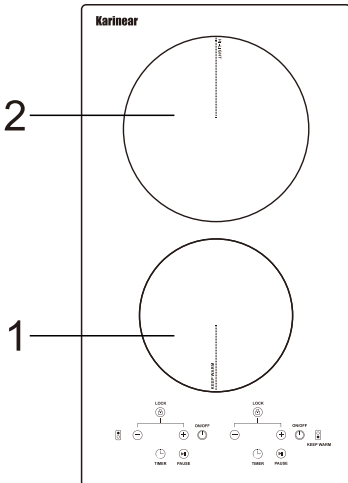

**KNC-D22058-UL/KNC-D22058-UL-LH06/
KNC-D22058-UL-LH07/KNC-D22058-UL-LH09/
KNC-D21858-UL/KNC-D21858-UL-LH06/
KNC-D21858-UL-LH07/KNC-D21858-UL-LH09
KNC-D22058-MG-UL-208/KNC-D22058-MG-UL-226/
KNC-D22058-MG-UL-W**

1.165mm/600W
2.200mm/1400W

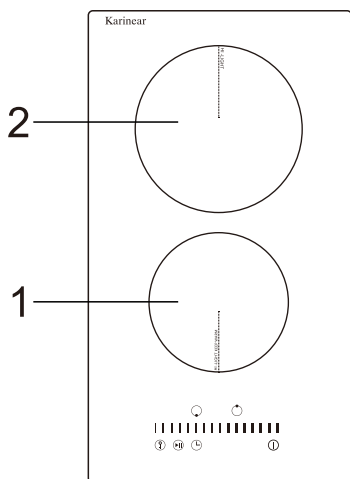

KNC-D22029-UL

KNC-D21829-UL

1.155mm/600W

2.185mm/1400W

PRODUCT OVERVIEW

II Control Panel

1.ON/OFF control	2.Child lock control
3.Timer control	4. Timer regulating control
5.Heating zone selection	6.Power regulating control
7.Pause Control	

Model: KNC-D22058-UL/KNC-D22058-UL-LH06/
 KNC-D22058-UL-LH07/KNC-D22058-UL-LH09
 KNC-D21858-UL/KNC-D21858-UL-LH06/
 KNC-D21858-UL-LH07/KNC-D21858-UL-LH09
 KNC-D22058-MG-UL-208/KNC-D22058-MG-UL-226/
 KNC-D22058-MG-UL-W

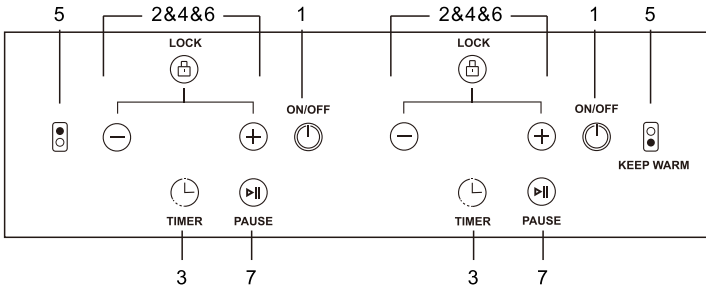

Model: KNC-D11047

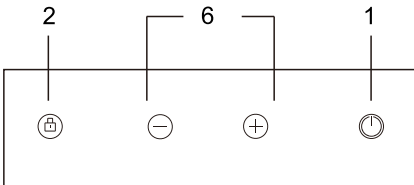

Model: KNC-D22029-UL/
 KNC-D21829-UL

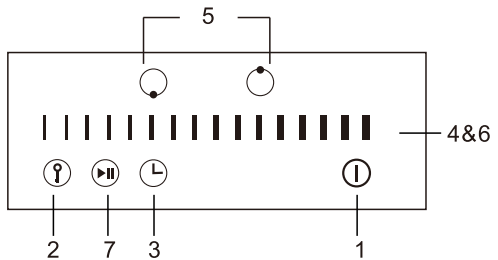

PRODUCT INFORMATION

The microcomputer ceramic cooker hob can meet different kinds of cuisine demands because of resistance wire heating, micro-computerized control and multi-power selection, really the optimal choice for modern families.

The ceramic cooker hob centers on customers and adopts personalized design. The hob has safe and reliable performances, making your life comfortable and enabling to fully enjoy the pleasure from life.

II Before using your New Ceramic Hob

- Read this guide, taking special note of the 'Safety Warnings' section.
- Remove any protective film that may still be on your ceramic hob.

II Using the Touch Controls

- The controls respond to touch, so you don't need to apply any pressure.
- Use the ball of your finger, not its tip.
- You will hear a beep each time a touch is registered.
- Make sure the controls are always clean, dry, and that there is no object (e.g. a utensil or a cloth) covering them. Even a thin film of water may make the controls difficult to operate.

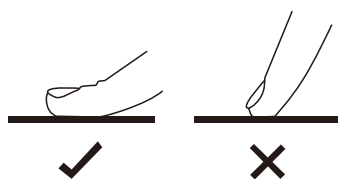

CHOOSING THE RIGHT COOKWARE

Do not use cookware with jagged edges or a curved base.



Make sure that the base of your pan is smooth, sits flat against the glass, and is the same size as the cooking zone. Always centre your pan on the cooking zone.

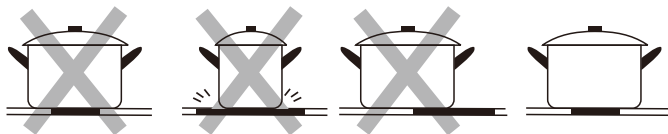

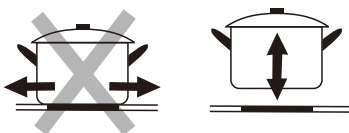

Always lift pans off the ceramic hob – do not slide, or they may scratch the glass.



USING YOUR CERAMIC HOB



II To start cooking

- After power on, the buzzer beeps once, all the indicators light up for 1 second then go out, indicating that the ceramic hob has entered the state of standby mode.

1. Touch the ON/OFF  control. all the indicators show "--" 

2. Place a suitable pan on the cooking zone that you wish to use.

- Make sure the bottom of the pan and the surface of the cooking zone are clean and dry.

3. Touching the heating zone selection control and a  indicator next to the key will flash "0" 

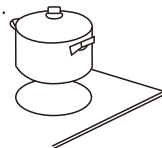

4. To set the power

After selecting of the heating zone, the indicator next to the zone will flash "5", by sliding to select the power level.

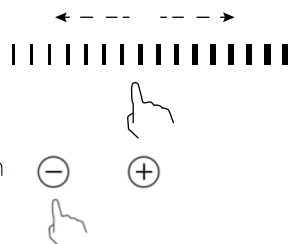

For models with a touch control, please touching the button - or + to set a power level.

*If you don't choose a heat setting within 1 minute, the ceramic hob will automatically switch off. You will need to start again at step 1.

*You can modify the heat setting at any time during cooking.

II When you have finished cooking

1. Touching the heating zone selection control that you wish to switch off

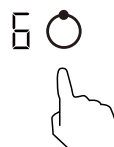

2. Turn the cooking zone off by touch the - to "0", make sure the display shows "0".



3. Beware of hot surfaces

"H" will show which cooking zone is hot to touch. It will disappear when the surface has cooled down to a safe temperature. It can also be used as an energy saving function if you want to heat further pans, use the hotplate that is still hot.



4. Turn the whole cooktop off by touching the "ON/OFF" control.



LOCKING THE CONTROLS

- You can lock the controls to prevent unintended use (for example children accidentally turning the cooking zones on).
- When the controls are locked, all the controls except the ON/OFF control are disabled.

II To lock the controls

Touch the keylock  control. The timer indicator will show "Lo "





Some models do not have a lock key, touch "-" and "+" key simultaneously to active child lock function.





II To unlock the controls

1. Make sure the ceramic hob is turned on.
2. Touch and hold the keylock control  for 3-5 sec.
Some models by touch - and + key simultaneously for 3-5 sec.
3. You can now start using your ceramic hob.



When the hob is in the lock mode, all the controls are disabled except the ON/OFF , stop&go control  you can always turn the ceramic hob off with the ON/OFF  control in an emergency, but you shall unlock the hob first in the next operation

II Stop&go Controls (for Available Models)

Touch the heating zone selection control, then touch the  key, the heating zone will stop to work, LED show "11". If you want to restart to work, touch the  key again.



II Over-Temperature Protection

A sensor installed in the hob continuously measures the temperature on the hob surface. If an excessively high temperature is detected, the hob will be automatically switched off.

When the temperature on the hob surface returns to normal, the ceramic hob becomes operational again..

II Residual Heat Warning

When the hob has been operating for some time, there will be some residual heat. The letter "H" appears to warn you to keep away from it.



II Auto Shutdown

Another safety feature of the hob is auto shut down. This occurs whenever you forget to switch off a cooking zone. The default shutdown times are shown in the table below:

Power level	1	2	3	4	5	6	7	8	9
Default working timer (hour)	8	8	8	4	4	4	2	2	2

USING THE TIMER

- You can use the timer to set it to turn one cooking zone off or more than one after the set time is up.
- You can set the timer for up to 60 minutes. If the setting time exceeds 60 minutes, the timer will automatically return to 0 minute.

II Setting the timer for the whole hob

If the user needs to set the timer function for the whole hob, please follow the steps below:

1. Turn on the machine, touch the timer control, the timer indicator show "30" Touch "+" or "-" to set the timer.



(For Slider control model)

The single digit code tube starts to flash, then slide the slider bar to set the single digit timing, and click the timing button again, the ten-digit digital tube begins to flash, then you can set the ten-digit timing

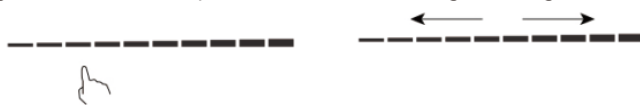

2. When the time is set, choose the heating zone and heating level, it will begin to count down immediately. The display will show the remaining time and the timer indicator flash for 5 seconds.

3. Hold the "-" to show "00", the timer is canceled, and the "--" will show in the minute display.



If you do not choose the heating zone and heating level, it will automatically shut down the machine after one minute. When the function timer time countdown is 0, the buzzer rings 30 times as a reminder (once per second).

NOTE: The heating will not stop after the end of this status timer, please switch off the machine in time.



II Setting the timer to turn one cooking zone off



1. Touching the heating zone selection control



2. Touch the timer control (🕒), the timer indicator show "30"



3. Set the time by sliding .



Hint: Press the timer control first time to increase or decrease the setting by 1 minute intervals.

Stay press the timer control second time to decrease or increase the setting by 10 minutes interval.

Some models by touch - or + to set the time.



4. Touching the heating zone selection control, and then touch the Timer, hold the "--" to show "00", the timer is canceled, and the "--" will show in the minute display

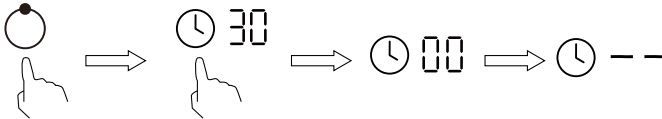

5. When the time is set, it will begin to count down immediately.

The display will show the remaining time and the timer indicator flash for 5 seconds.

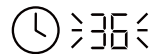

NOTE: The red dot next to power level indicator will illuminate indicating that zone is selected.



6. Buzzer will beep for 30 seconds and the timer indicator shows "--" when the set time finished.

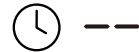

II Setting the timer to turn more than one cooking zone off

1. If more than one heating zone use this function, the timer indicator will show the lowest time.

(e.g. zone 1# setting time of 3 minutes, zone 2# setting time of 6 minutes, the timer indicator shows "3".)

NOTE: The red dot next to power level indicator will flash.

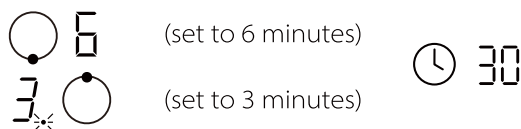

If you want to check the set time of other heating zone, touch the heating zone selection control. The timer will indicate its set time.

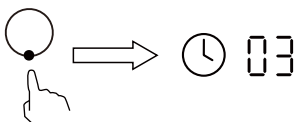

2. When cooking timer expires, the corresponding cooking zone will be switch off automatically and show "H".



NOTE: If you want to change the time after the timer is set, you have to start from step 1

TROUBLESHOOTING

Error code	Possible cause	What to do
E4	high temperature	Please contact supplier: aftersales@karinearappliance.com
F4	circuit open	Please contact supplier: aftersales@karinearappliance.com
Indicator Flash	Continuous operation for more than 3 hours	Turn it back on in an hour

COOKING GUIDELINES (FOR REFERENCE ONLY)

II Cooking Tips

- When food comes to the boil, reduce the power setting.
- Using a lid will reduce cooking times and save energy by retaining the heat.
- Minimize the amount of liquid or fat to reduce cooking times.
- Start cooking on a high setting and reduce the setting when the food has heated through.

II Simmering, cooking rice

- Simmering occurs below boiling point, at around 85°C, when bubbles are just rising occasionally to the surface of the cooking liquid. It is the key to delicious soups and tender stews because the flavours develop without overcooking the food. You should also cook egg-based and flourthickened sauces below boiling point.
- Some tasks, including cooking rice by the absorption method, may require a setting higher than the lowest setting to ensure the food is cooked properly in the time recommended.

II Searing steak

To cook juicy flavoursome steaks:

1. Stand the meat at room temperature for about 20 minutes before cooking.
2. Heat up a heavy-based frying pan.
3. Brush both sides of the steak with oil. Drizzle a small amount of oil into the hot pan and then lower the meat onto the hot pan.
4. Turn the steak only once during cooking. The exact cooking time will depend on the thickness of the steak and how cooked you want it. Times may vary from about 2 – 8 minutes per side. Press the steak to gauge how cooked it is – the firmer it feels the more 'well done' it will be.
5. Leave the steak to rest on a warm plate for a few minutes to allow it to relax and become tender before serving.

II For stir-frying

1. Choose an ceramic compatible flat-based wok or a large frying pan.
2. Have all the ingredients and equipment ready. Stir-frying should be quick. If cooking large quantities, cook the food in several smaller batches.
3. Preheat the pan briefly and add two tablespoons of oil.
4. Cook any meat first, put it aside and keep warm.
5. Stir-fry the vegetables. When they are hot but still crisp, turn the cooking zone to a lower setting, return the meat to the pan and add your sauce.
6. Stir the ingredients gently to make sure they are heated through.
7. Serve immediately.

HEAT SETTINGS

Heat setting	Suitability
1 - 2	<ul style="list-style-type: none">• delicate warming for small amounts of food• melting chocolate, butter, and foods that burn quickly• gentle simmering• slow warming
3 - 4	<ul style="list-style-type: none">• reheating• rapid simmering• cooking rice
5 - 6	<ul style="list-style-type: none">• pancakes
7 - 8	<ul style="list-style-type: none">• sauteing• cooking pasta
9	<ul style="list-style-type: none">• stir-frying• searing• bringing soup to the boil• boiling water

CARE AND CLEANING

What?	How?	Important!
<p>Everyday soiling on glass (fingerprints, marks, stains left by food or non-sugary spillovers on the glass)</p>	<ol style="list-style-type: none"> 1. Switch the power to the cooktop off. 2. Apply a cooktop cleaner while the glass is still warm (but not hot!) 3. Rinse and wipe dry with a clean cloth or paper towel. 4. Switch the power to the cooktop back on. 	<ul style="list-style-type: none"> • When the power to the cooktop is switched off, there will be no 'hot surface' indication but the cooking zone may still be hot! Take extreme care. • Heavy-duty scourers, some nylon scourers and harsh/abrasive cleaning agents may scratch the glass. Always read the label to check if your cleaner or scourer is suitable. • Never leave cleaning residue on the cooktop: the glass may become stained.
<p>Boilovers, melts, and hot sugary spills on the glass</p>	<p>Remove these immediately with a fish slice, palette knife or razor blade scraper suitable for ceramic glass cooktops, but beware of hot cooking zone surfaces:</p> <ol style="list-style-type: none"> 1. Switch the power to the cooktop off at the wall. 2. Hold the blade or utensil at a 30° angle and scrape the soiling or spill to a cool area of the cooktop. 3. Clean the soiling or spill up with a dish cloth or paper towel. 4. Follow steps 2 to 4 for 'Everyday soiling on glass' above. 	<ul style="list-style-type: none"> • Remove stains left by melts and sugary food or spillovers as soon as possible. If left to cool on the glass, they may be difficult to remove or even permanently damage the glass surface. • Cut hazard: when the safety cover is retracted, the blade in a scraper is razor-sharp. Use with extreme care and always store safely and out of reach of children.
<p>Spillovers on the touch controls</p>	<ol style="list-style-type: none"> 1. Switch the power to the cooktop off. 2. Soak up the spill 3. Wipe the touch control area with a clean damp sponge or cloth. 4. Wipe the area completely dry with a paper towel. 5. Switch the power to the cooktop back on. 	<ul style="list-style-type: none"> • The cooktop may beep and turn itself off, and the touch controls may not function while there is liquid on them. Make sure you wipe the touch control area dry before turning the cooktop back on.

HINTS AND TIPS

Problem	Possible causes	What to do
The cooktop cannot be turned on.	No power.	Make sure the cooktop is connected to the power supply and that it is switched on. Check whether there is a power outage in your home or area. If you've checked everything and the problem persists, call a qualified technician.
The touch controls are unresponsive.	The controls are locked.	Unlock the controls. See section 'Using your ceramic cooktop' for instructions.
The touch controls are difficult to operate.	There may be a slight film of water over the controls or you may be using the tip of your finger when touching the controls.	Make sure the touch control area is dry and use the ball of your finger when touching the controls.
The glass is being scratched.	Rough-edged cookware. Unsuitable, abrasive scourer or cleaning products being used.	Use cookware with flat and smooth bases. See 'Choosing the right cookware'. See 'Care and cleaning'.
Some pans make crackling or clicking noises.	This may be caused by the construction of your cookware (layers of different metals vibrating differently).	This is normal for cookware and does not indicate a fault.

TECHNICAL SPECIFICATION

Model	KNC-D11047
Cooking zones	1 Zones
Supply voltage/Frequency	120V~, 60Hz
Installed Electric Power	1100W
Product Size LxWxH(mm)	290X520X44 / 52

Model	KNC-D22058-UL/KNC-D22058-UL-LH06/ KNC-D22058-UL-LH07/KNC-D22058-ULLH09/ KNC-D22029-UL/KNC D21858-UL/ KNC-D21858-UL-LH06/KNC-D21858-UL-LH07/ KNC-D21858-UL-LH09/KNC-D21829-UL KNC-D22058-MG-UL-208/KNC-D22058-MG-UL-226/ KNC-D22058-MG-UL-W
Cooking zones	2 Zones
Supply voltage/Frequency	120V~, 60Hz
Installed Electric Power	2000W
Product Size LxWxH(mm)	290X520X44 / 52

Weight and Dimensions are approximate. Because we continually strive to improve our products we may change specifications and designs without prior notice.

II Freestanding hob

Please install the four feet at the bottom and put them flat on the table. As below show:

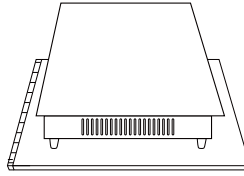

II Before locating the fixing brackets

The unit should be placed on a stable, smooth surface (use the packaging). Do not apply force onto the controls protruding from the hob.

Fix the hob on the work surface by screw four brackets on the bottom of hob (see picture) after installation.

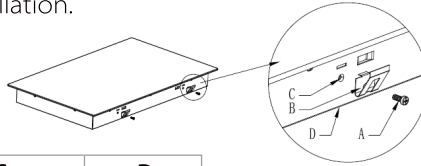

A	B	C	D
screw	bracket	Screw hole	base

Adjust the bracket position to suit for different work surface's thickness.

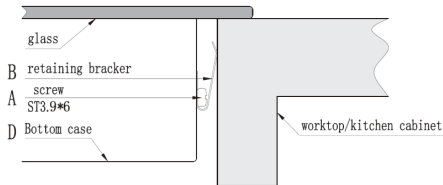

II Cautions

1. The ceramic cooker hob must be installed by qualified personnel or technicians. We have professionals at your service. Please never conduct the operation by yourself.
2. The ceramic cooker hob shall not be mounted to cooling equipment, dishwashers and rotary dryers.
3. The ceramic cooker hob shall be installed such that better heat radiation can be ensured to enhance its reliability.
4. The wall and induced heating zone above the work surface shall withstand heat.
5. To avoid any damage, the sandwich layer and adhesive must be resistant to heat.
6. A steam cleaner is not to be used.

7. This ceramic can be connected only to a supply with system impedance no more than 0.427 ohm. In case necessary, please consult your supply authority for system impedance information.

II Connecting the hob to the mains power supply

The power supply should be connected in compliance with the relevant standard, The method of connection is shown below.



1. If the cable is damaged or needs replacing, this should be done by an after-sales technician using the proper tools, so as to avoid any accidents.
2. If the appliance is being connected directly to the mains supply, an omnipolar circuit breaker must be installed with a minimum gap of 3mm between the contacts.
3. The installer must ensure that the correct electrical connection has been made and that it complies with safety regulations.
4. The cable must not be bent or compressed.
5. The cable must be checked regularly and only replaced by a properly qualified person.



DISPOSAL: Do not dispose this product as unsorted municipal waste. Collection of such waste separately for special treatment is necessary.

Caring for the environment

Disposal of the packing material The cardboard box and packing materials protect the appliance during shipping. They have been designed to be biodegradable and recyclable. Ensure that any plastic wrappings, bags, etc. are disposed of safely and kept out of the reach of children. Danger of suffocation!

Disposal of your old appliance Electrical and electronic appliances contain valuable materials. They also contain certain substances, compounds and components which were essential for the proper functioning and safe use of the equipment. Handling these materials improperly by disposing of them in your household waste can be harmful to your health and the environment. Therefore, please do not dispose of your old appliance with regular household waste and follow local regulations on proper disposal. Consult with local authorities, dealers or Miele in order to dispose of and recycle electrical and electronic appliances. Miele assumes no responsibility for deleting any personal data left on the appliance being disposed. Please ensure that your old appliance is kept away from children until removal. Observe safety requirements for appliances that may tip over or pose an entrapment hazard.

This device complies with part 15 of the FCC Rules. Operation is subject to the following two conditions: (1) this device may not cause harmful interference, and (2) this device must accept any interference received, including interference that may cause undesired operation.

Changes or modifications not expressly approved by the party responsible for compliance could void the user's authority to operate the equipment.

NOTE: This equipment has been tested and found to comply with the limits for a Class B digital device, pursuant to Part 15 of the FCC Rules. These limits are designed to provide reasonable protection against harmful interference in a residential installation. This equipment generates, uses and can radiate radio frequency energy and, if not installed and used in accordance with the instructions, may cause harmful interference to radio communications. However, there is no guarantee that interference will not occur in a particular installation. If this equipment does cause harmful interference to radio or television reception, which can be determined by turning the equipment off and on, the user is encouraged to try to correct the interference by one or more of the following measures:

- Reorient or relocate the receiving antenna.
- Increase the separation between the equipment and receiver.
- Connect the equipment into an outlet on a circuit different from that to which the receiver is connected.
- Consult the dealer or an experienced radio/TV technician for help.

FCC Warning Statement

Changes or modifications not expressly approved by the party responsible for compliance could void the user's authority to operate the equipment. This equipment has been tested and found to comply with the limits for a Class B digital device, pursuant to Part 15 of the FCC Rules. These limits are designed to provide reasonable protection against harmful interference in a residential installation. This equipment generates uses and can radiate radio frequency energy and, if not installed and used in accordance with the instructions, may cause harmful interference to radio communications. However, there is no guarantee that interference will not occur in a particular installation. If this equipment does cause harmful interference to radio or television reception, which can be determined by turning the equipment off and on, the user is encouraged to try to correct the interference by one or more of the following measures:

- Reorient or relocate the receiving antenna.
- Increase the separation between the equipment and receiver.
- Connect the equipment into an outlet on a circuit different from that to which the receiver is connected.
- Consult the dealer or an experienced radio/TV technician for help.

This device complies with part 15 of the FCC Rules. Operation is subject to the following two conditions: (1) This device may not cause harmful interference, and (2) this device must accept any interference received, including interference that may cause undesired operation.