

VEVOR[®]

TOUGH TOOLS, HALF PRICE

Technical Support and E-Warranty Certificate

www.vevor.com/support

FABRIC ROOM DIVIDE

USER MANUAL

PFDMFGHS01

PFDMFGSH02

PFDMFGMS03

We continue to be committed to provide you tools with competitive price. "Save Half", "Half Price" or any other similar expressions used by us only represents an estimate of savings you might benefit from buying certain tools with us compared to the major top brands and does not necessarily mean to cover all categories of tools offered by us. You are kindly reminded to verify carefully when you are placing an order with us if you are actually Saving Half in comparison with the top major brands.

VEVOR®

TOUGH TOOLS, HALF PRICE

FABRIC ROOM DIVIDE

PFDMFGHS01

PFDMFGSH02

PFDMFGMS03

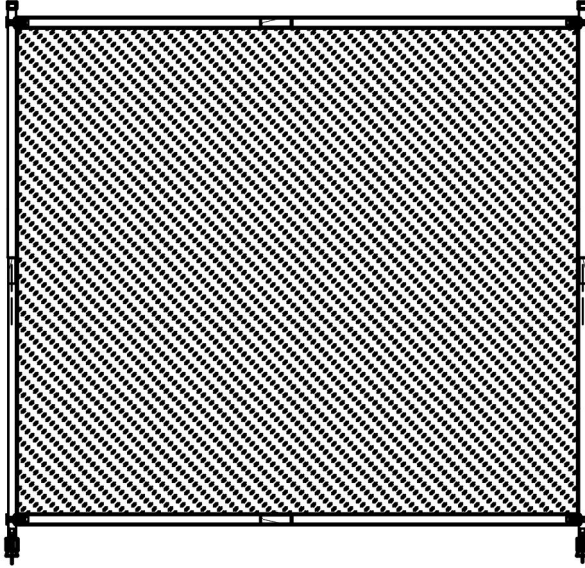

NEED HELP? CONTACT US!

Have product questions? Need technical support? Please feel free to contact us:

Technical Support and E-Warranty Certificate
www.vevor.com/support

This is the original instruction, please read all manual instructions carefully before operating. VEVOR reserves a clear interpretation of our user manual. The appearance of the product shall be subject to the product you received. Please forgive us that we won't inform you again if there are any technology or software updates on our product.

SAFETY INSTRUCTIONS

WARNING:

Read this material before using this product. Failure to do so can result in serious injury.

Assembly precautions









1. Assemble only according to these instructions. Improper assembly can create hazards.
2. Wear ANSI-approved safety goggles and heavy-duty work gloves during assembly.
3. Keep the assembly area clean and well-lit.
4. Keep bystanders out of the area during assembly.
5. Do not assemble if tired or when under the influence of alcohol, drugs or medication.
6. The product capabilities apply to properly and completely assembled products only.
7. Assemble on a flat, level, hard and smooth surface capable of safely supporting the Fabric Room Divide.
8. For additional information regarding the parts listed in the following pages, please refer to the Assembly Diagram of this manual. Unwrap and separate all parts in a clean work area.

Use precautions

1. DO NOT SIT OR STAND ON THIS ITEM.
2. This product is not a toy. Do not allow children to play with or near this item.
3. Do not exceed specified weight capacities.
4. Use only on a flat, level, hard, and smooth surface that can safely support a fully loaded Fabric Room Divide.
5. Use as intended only.
6. Inspect before every use; do not use if parts are loose or damaged.

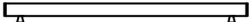
SAVE THIS MANUAL

PARTS LIST

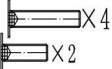
| | | |
|---|---|-----------|
| A |  | 2 |
| B |  | 2 |
| C |  | 2 |
| D |  | 2 |
| E |  | 2 |
| F |  | 1 |
| G |  | 1 |
| H |  | 1 |
| I |  | Preloaded |

NOTE: F accessories are spare screws for gift; H is the fabric of the screen, pay attention not to get dirty when installing.

ASSEMBLY STEP

STEP 1

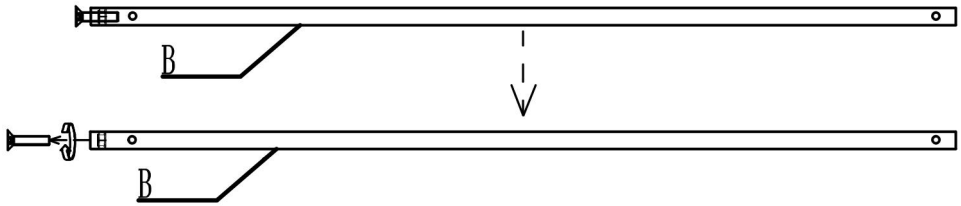

Unscrew from material B and set aside.

X2

STEP 2

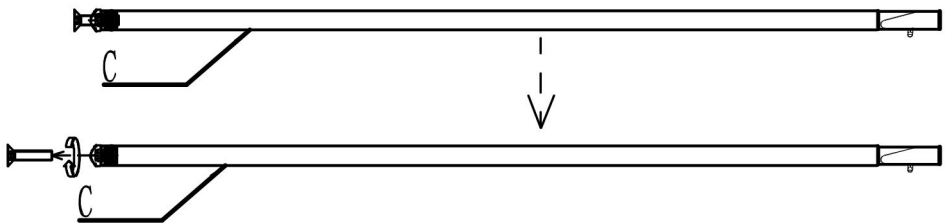

Unscrew from material C and set aside.

X2

STEP 3

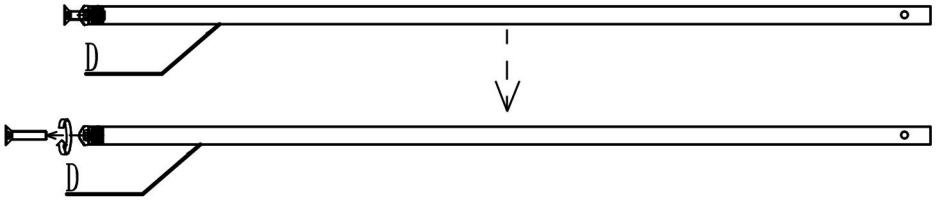

Unscrew from material D and set aside.

X2

STEP 4

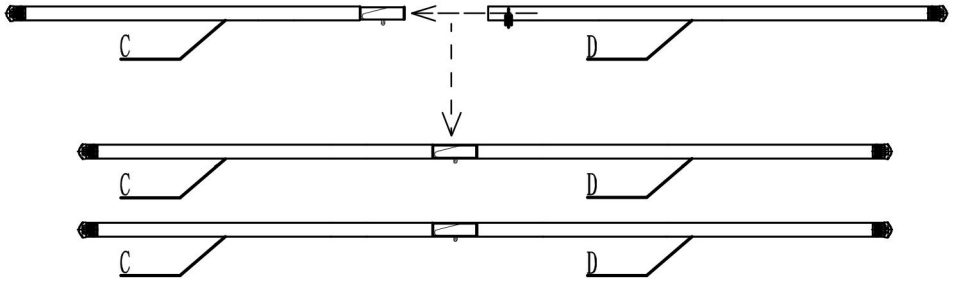

Connect material C with material D, 2 in total.

STEP 5

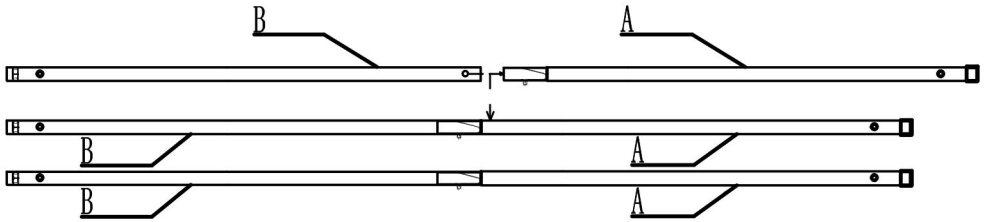

Connect material B with material A, 2 in total.

STEP 6

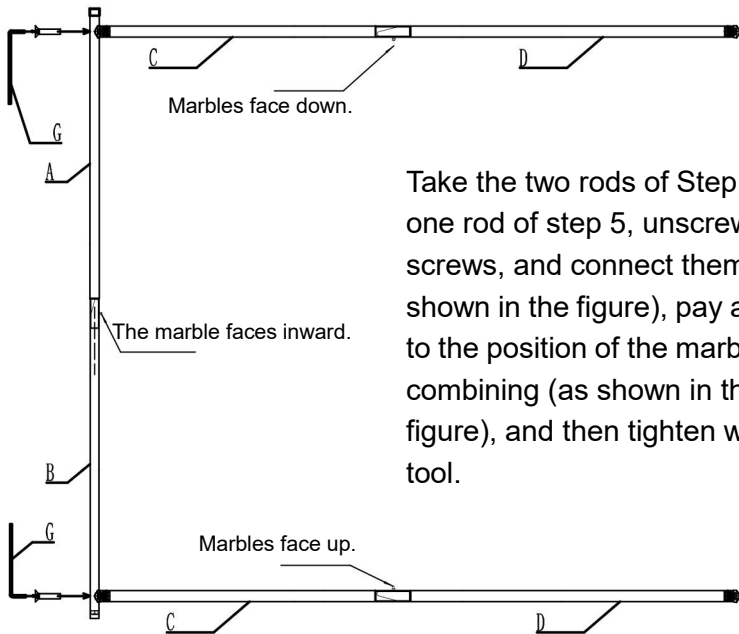

Take the two rods of Step 4 and one rod of step 5, unscrew the screws, and connect them (as shown in the figure), pay attention to the position of the marble when combining (as shown in the figure), and then tighten with G tool.

STEP 7

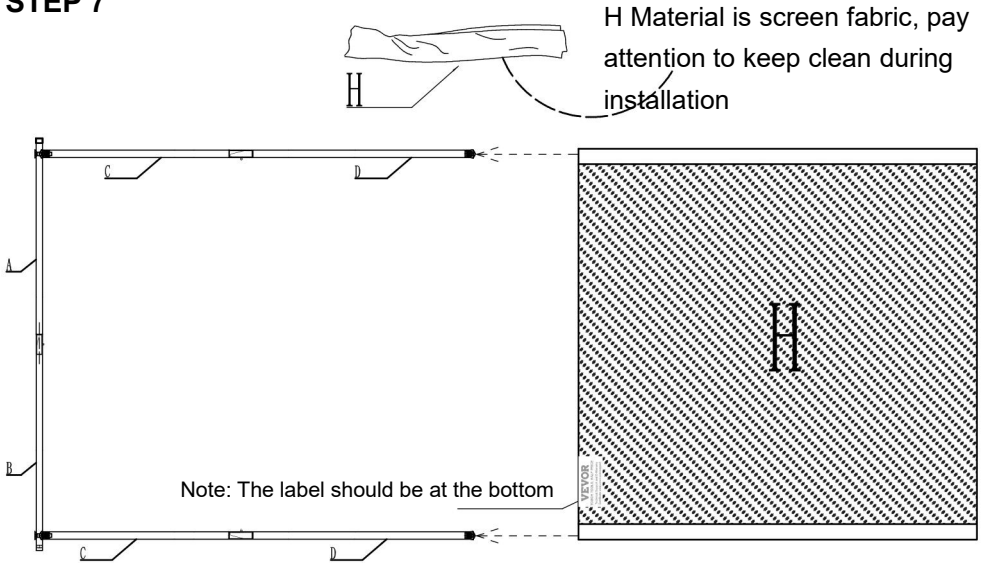

Insert the sleeve of material H into the upper and lower cross bars.

STEP 8

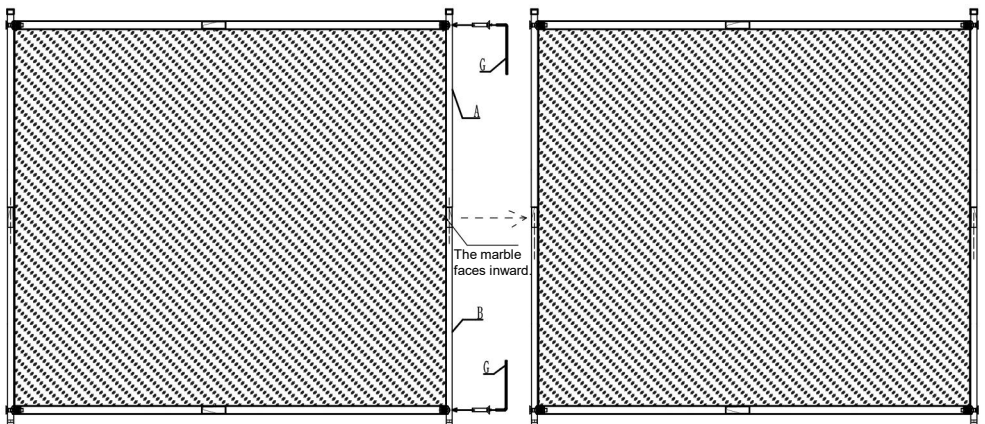

Take the other combined pipe in Step 5 and assemble it in the frame of Step 7, pay attention to the screw that is unscrewed first, and then connect and tighten it (as shown in the figure), pay attention to the position of the marble when assembling it (as shown in the figure), and then tighten it with the G tool.

STEP 9

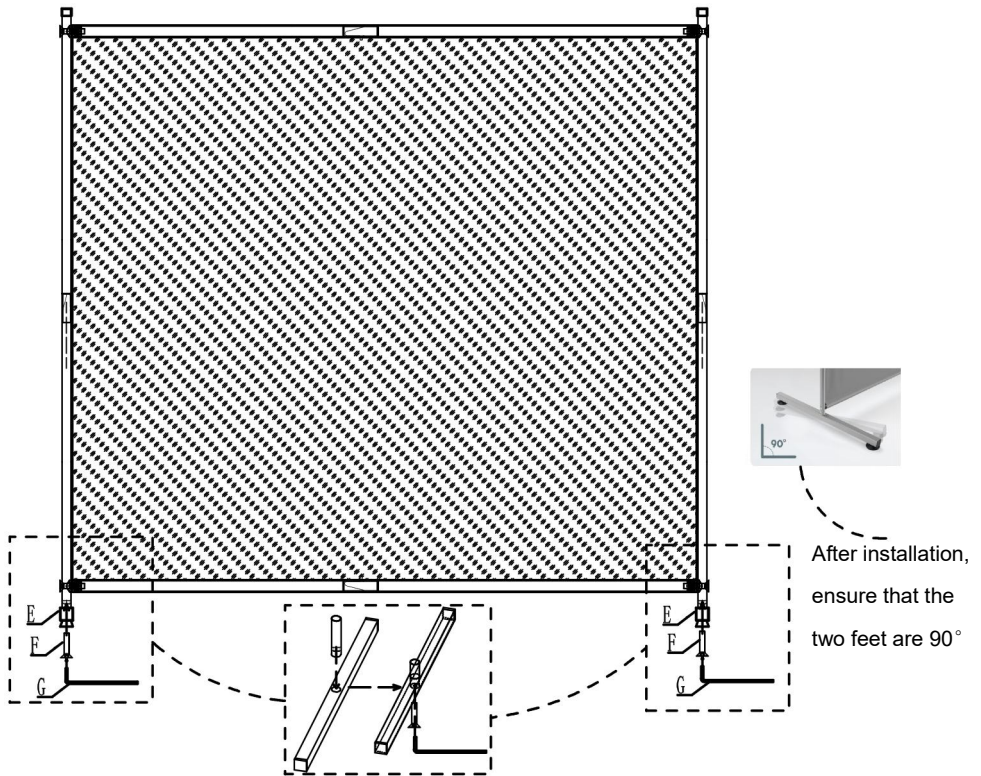

Assemble 2 pieces of material E into the frame in step 8;

Note: In order to make the whole shelf more stable, when installing the foot, first insert the pipe into the foot, then through the unscrewed screw, and then connect, and tighten with the G tool

STEP 10

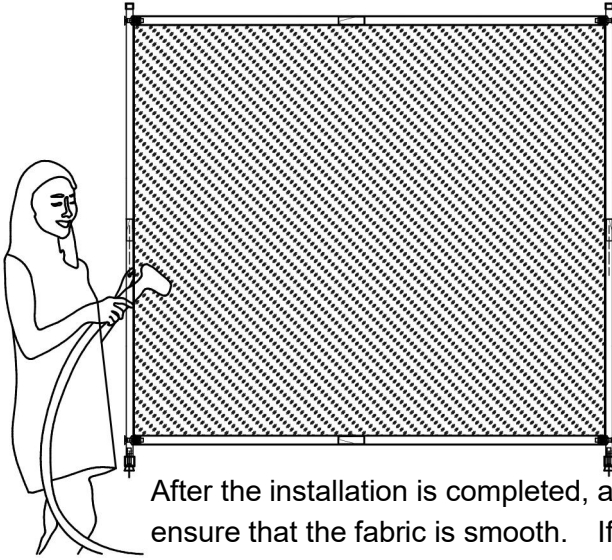

After the installation is completed, arrange the fabric to ensure that the fabric is smooth. If the fabric has wrinkles, you can use a household hanging press to iron it.

STEP 11

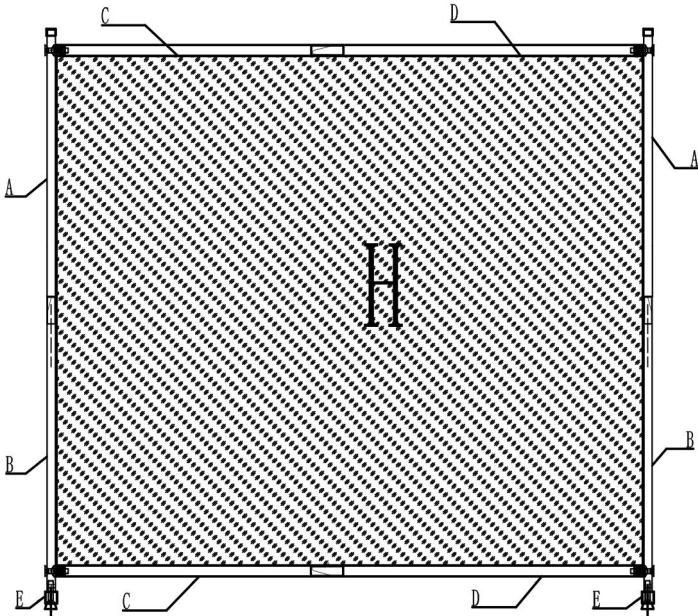

PRODUCT PARAMETER

| Model | PFDMFGHS01 | PFDMFGSH02 | PFDMFGMS03 |
|------------------|-----------------|------------|----------------|
| Colour | Black | Gray | Cream-Coloured |
| Number of panels | 1 | | |
| Product Size | 1810*1815*500mm | | |

Manufacturer: Shanghaimuxinmuyeyouxiangongsi

Address: Shuangchenglu 803nong11hao1602A-1609shi, baoshanqu, shanghai 200000 CN.

Imported to AUS: SIHAO PTY LTD. 1 ROKEVA STREETEASTWOOD NSW 2122 Australia

Imported to USA: Sanven Technology Ltd. Suite 250, 9166 Anaheim Place, Rancho Cucamonga, CA 91730

| | |
|-----------|------------|
| UK | REP |
|-----------|------------|

YH CONSULTING LIMITED. C/O YH Consulting Limited Office 147, Centurion House, London Road, Staines-upon-Thames, Surrey, TW18 4AX

| | |
|-----------|------------|
| EC | REP |
|-----------|------------|

E-CrossStu GmbH
Mainzer Landstr.69,
60329 Frankfurt am Main.

VEVOR[®]

TOUGH TOOLS, HALF PRICE

Technical Support and E-Warranty Certificate

www.vevor.com/support

VEVOR[®]

TOUGH TOOLS, HALF PRICE

Technique Certificat d'assistance et de garantie électronique

www.vevor.com/support

CLOISON DE SÉPARATION EN TISSU

MANUEL D' utilisation

PFDMFGHS01

PFDMFGSH02

PFDMFGMS03

Nous continuons à nous engager à vous fournir des outils à des prix compétitifs. « Économisez la moitié », « Moitié prix » ou toute autre expression similaire utilisée par nous uniquement représente une estimation des économies dont vous pourriez bénéficier en achetant certains outils avec nous par rapport aux grandes marques et ne signifie pas nécessairement couverture toutes les catégories d'outils que nous proposons. Nous vous rappelons de bien vouloir vérifier soigneusement lorsque vous passez une commande chez nous si vous êtes réellement Économie Moitié par rapport aux plus grandes marques.

VEVOR®

TOUGH TOOLS, HALF PRICE

FABRIC ROOM DIVIDE

PFDMFGHS01

PFDMFGSH02

PFDMFGMS03

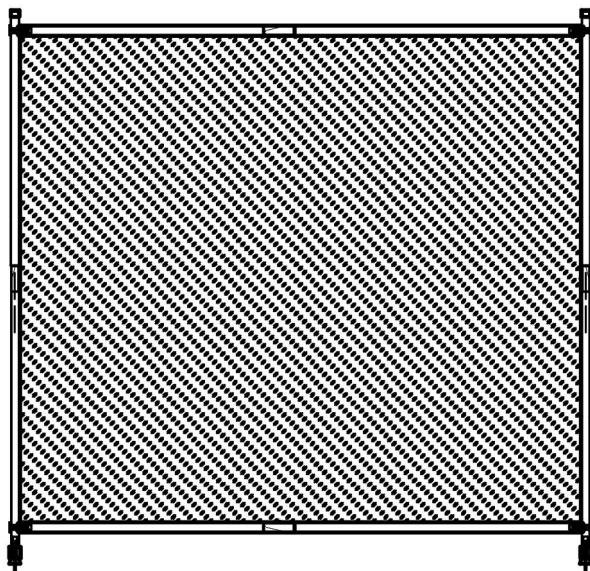

BESOIN D'AIDE? CONTACTEZ-NOUS!

Vous avez des questions sur nos produits ? Vous avez besoin d'une assistance technique ? N'hésitez pas à nous contacter :

Assistance technique et certificat de garantie électronique

www.vevor.com/support

Il s'agit de la notice d'utilisation d'origine. Veuillez lire attentivement toutes les instructions du manuel avant de l'utiliser. VEVOR se réserve le droit d'interpréter clairement notre manuel d'utilisation. L'apparence du produit dépend du produit que vous avez reçu. Veuillez nous excuser, nous ne vous informerons plus si des mises à jour technologiques ou logicielles sont disponibles sur notre produit.

SAFETY INSTRUCTIONS

AVERTISSEMENT:

Lisez ce document avant d'utiliser ce produit. Le non-respect de ces instructions peut entraîner des blessures graves.

Précautions de montage

9. Assembler uniquement selon ces instructions. Un assemblage incorrect peut créer des dangers.
10. Portez des lunettes de sécurité approuvées ANSI et des gants de travail robustes pendant l'assemblage.
11. Gardez la zone de montage propre et bien éclairée.
12. Gardez les spectateurs hors de la zone pendant le montage.
13. Ne pas monter si vous êtes fatigué ou sous l'influence de l'alcool, de drogues ou de médicaments.
14. Les capacités du produit s'appliquent uniquement aux produits correctement et entièrement assemblés.
15. Assemblez-le sur une surface plane, de niveau, dure et lisse capable de supporter en toute sécurité le séparateur de pièce en tissu.
16. Pour plus d'informations sur les pièces répertoriées dans les pages suivantes, reportez-vous au schéma d'assemblage de ce manuel. Déballez et séparez toutes les pièces dans un espace de travail propre.









Précautions d'emploi

7. NE PAS S'ASSEOIR OU SE TENIR DEBOUT SUR CET ARTICLE.
8. Ce produit n'est pas un jouet. Ne laissez pas les enfants jouer avec ou à proximité de cet article.
9. Ne pas dépasser la quantité spécifiée capacités de poids.
10. Utiliser uniquement sur une surface plane, de niveau, dure et lisse pouvant supporter en toute sécurité une cloison de séparation en tissu entièrement chargée.
11. Utiliser uniquement comme prévu.

12. Inspectez avant chaque utilisation ; ne pas utiliser si des pièces sont desserrées ou endommagées.

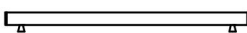
CONSERVER CE MANUEL

PARTS LIST

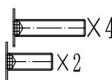
| | | |
|----|---|------------|
| UN |  | 2 |
| B |  | 2 |
| C |  | 2 |
| D |  | 2 |
| E |  | 2 |
| F |  | 1 |
| G |  | 1 |
| H |  | 1 |
| je |  | P rechargé |

REMARQUE : Les accessoires F sont des vis de rechange en cadeau ; H est le tissu de l'écran, faites attention à ne pas vous salir lors de l'installation.

ASSEMBLY STEP

ÉTAPE 1

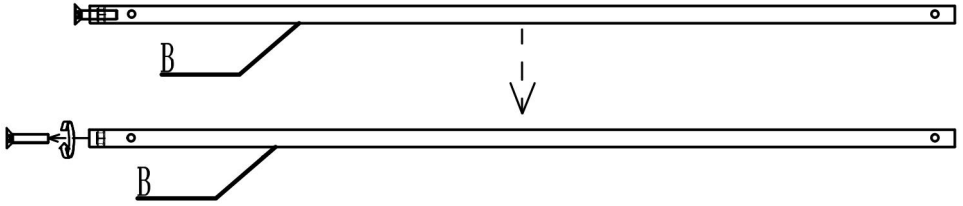

Unscrew from material B and set aside.

X2

ÉTAPE 2

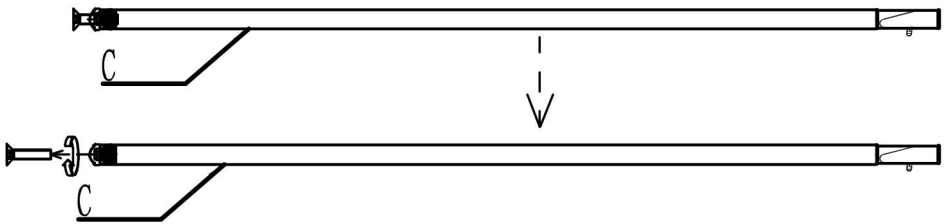

Unscrew from material C and set aside.

X2

ÉTAPE 3

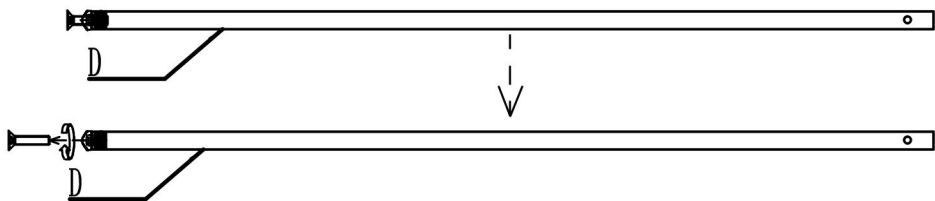

Unscrew from material D and set aside.

X2

ÉTAPE 4

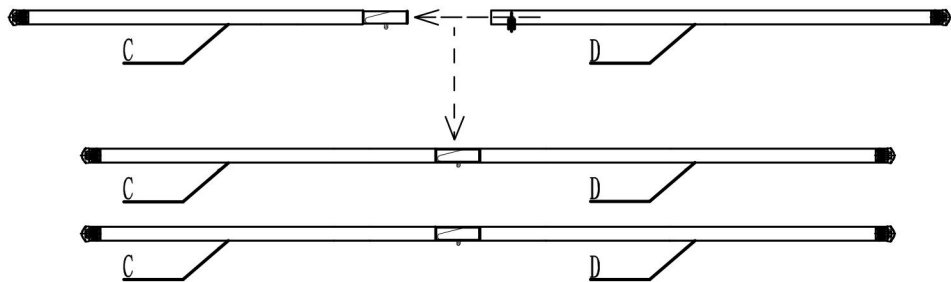

Connect material C with material D, 2 in total.

ÉTAPE 5

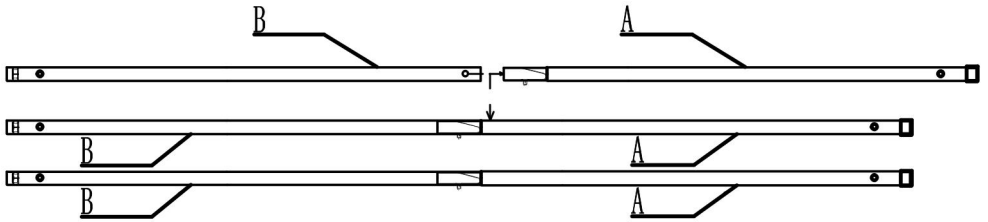

Connect material B with material A, 2 in total.

ÉTAPE 6

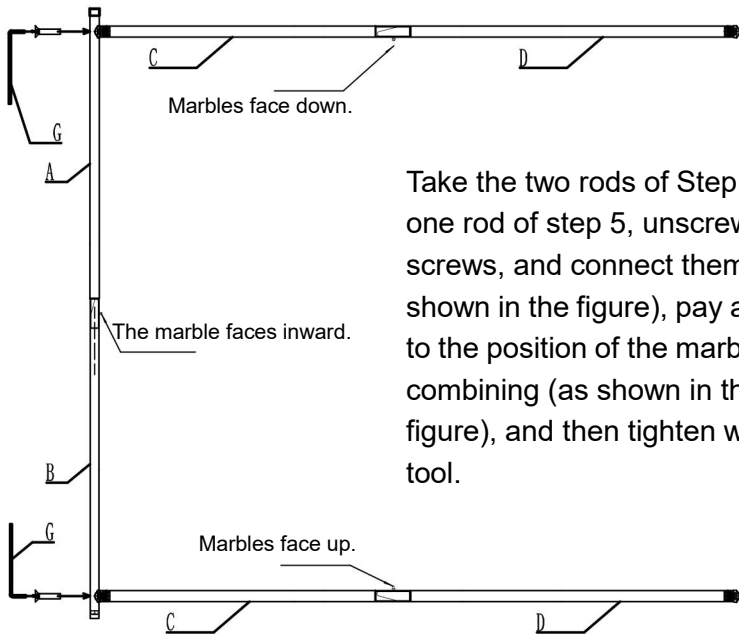

Take the two rods of Step 4 and one rod of step 5, unscrew the screws, and connect them (as shown in the figure), pay attention to the position of the marble when combining (as shown in the figure), and then tighten with G tool.

ÉTAPE 7

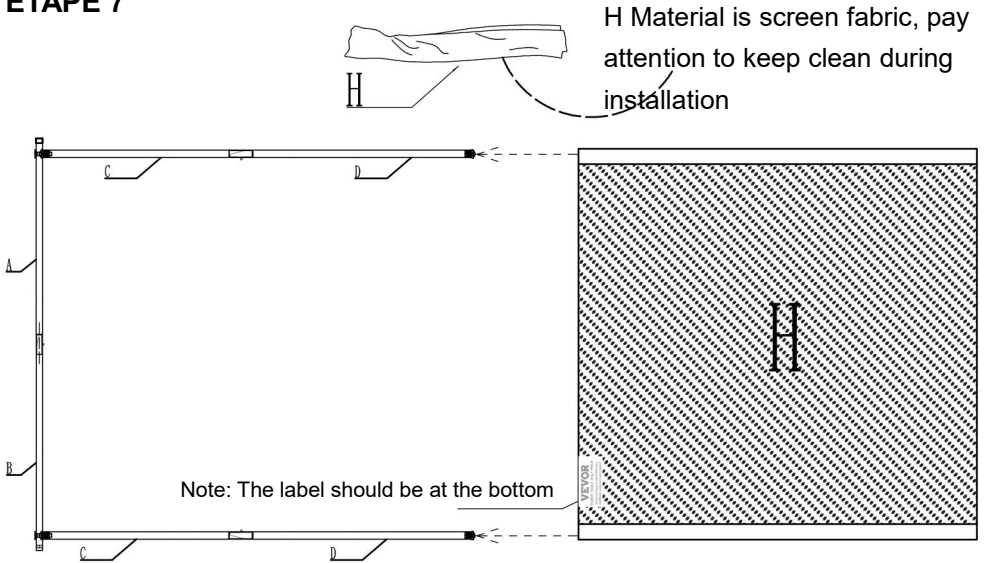

Insert the sleeve of material H into the upper and lower cross bars.

ÉTAPE 8

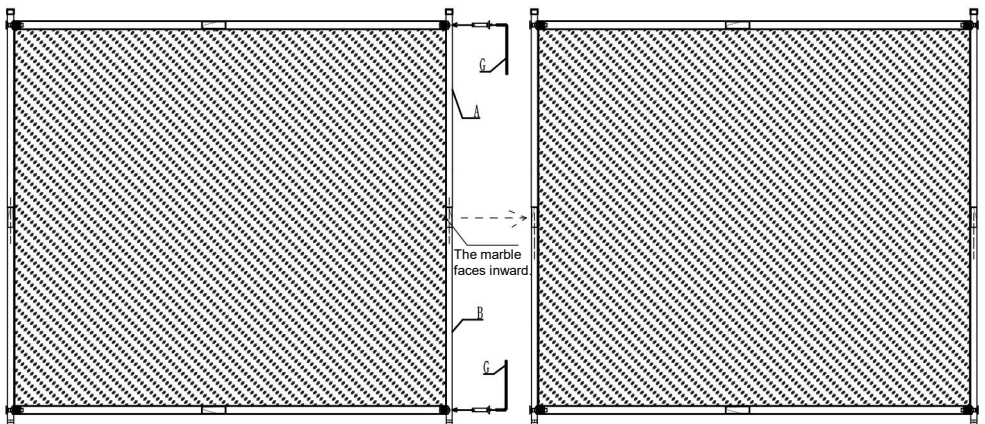

Take the other combined pipe in Step 5 and assemble it in the frame of Step 7, pay attention to the screw that is unscrewed first, and then connect and tighten it (as shown in the figure), pay attention to the position of the marble when assembling it (as shown in the figure), and then tighten it with the G tool.

ÉTAPE 9

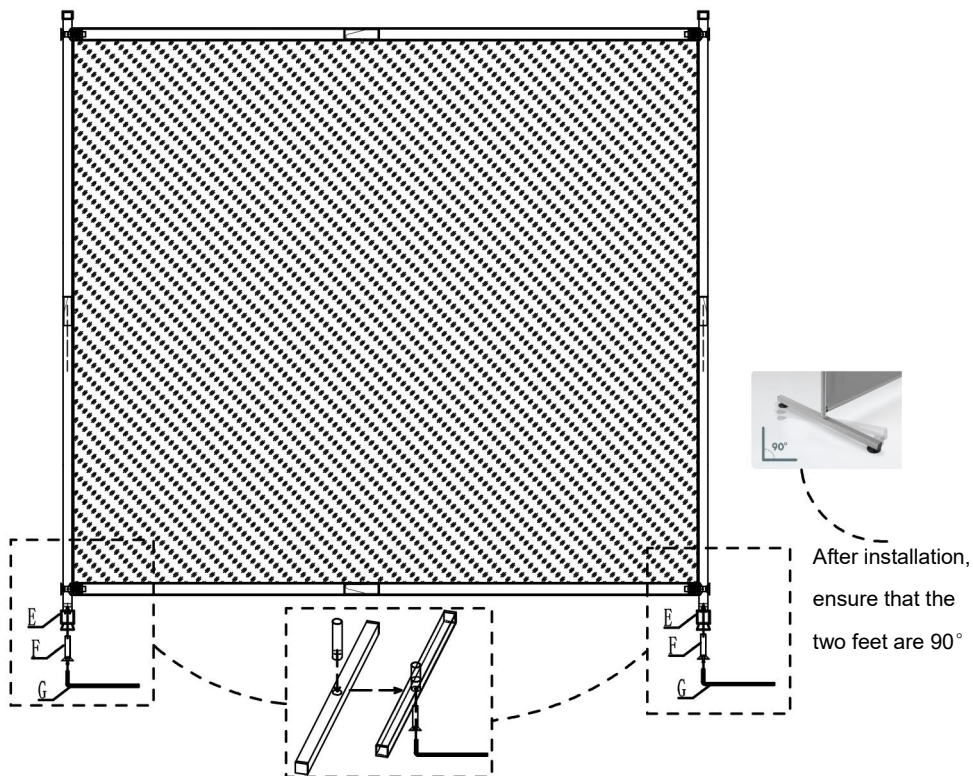

Assemble 2 pieces of material E into the frame in step 8;

Note: In order to make the whole shelf more stable, when installing the foot, first insert the pipe into the foot, then through the unscrewed screw, and then connect, and tighten with the G tool

ÉTAPE 10

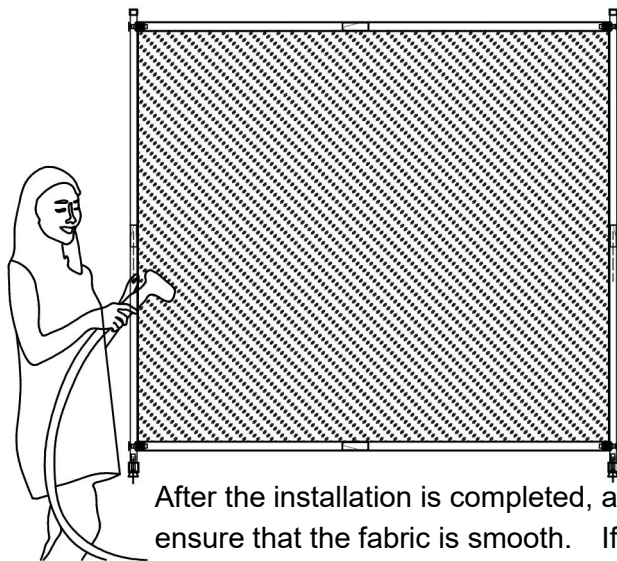

After the installation is completed, arrange the fabric to ensure that the fabric is smooth. If the fabric has wrinkles, you can use a household hanging press to iron it.

ÉTAPE 11

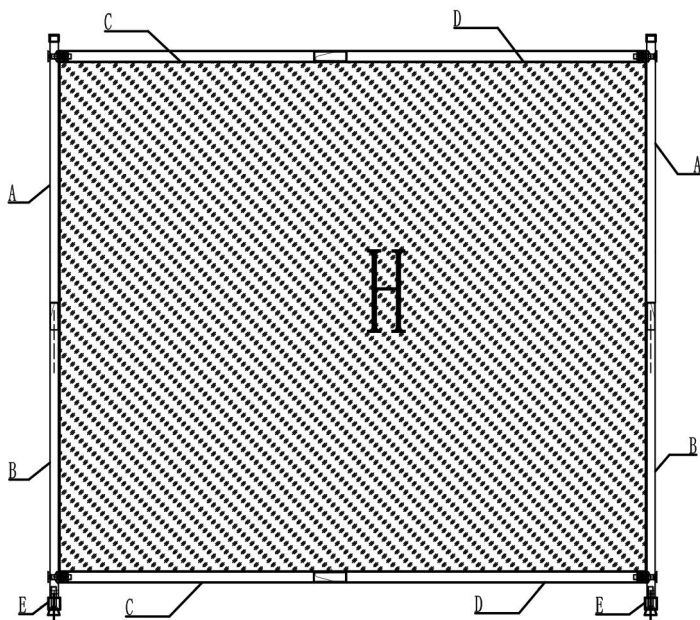

PRODUCT PARAMETER

| Modèle | PFDMSGHS01 | PFDMSGSH02 | PFDMSGMS03 |
|--------------------|-----------------|------------|---------------|
| Couleur | Noir | Gris | Couleur crème |
| Nombre de panneaux | 1 | | |
| Taille du produit | 1810*1815*500mm | | |

Fabricant : Shanghaimuxinmuyeyouxiangongsi

Adresse : Shuangchenglu 803nong11hao1602A-1609shi, baoshanqu, Shanghai 200 000 CN.

Importé en Australie : SIHAO PTY LTD. 1 ROKEVA STREETEASTWOOD

NSW 2122 Australie

Importé aux États-Unis : Sanven Technology Ltd. Suite 250, 9166 Anaheim

Lieu, Rancho Cucamonga, CA 91730

| | |
|-----------|------------|
| UK | REP |
|-----------|------------|

YH CONSULTING LIMITED. C/O YH Consulting
Limited Office 147, Centurion House, London
Road, Staines-upon-Thames, Surrey, TW18 4AX

| | |
|-----------|------------|
| EC | REP |
|-----------|------------|

E-CrossStu GmbH
Mainzer Landstr.69,
60329 Frankfurt am Main.

VEVOR[®]

TOUGH TOOLS, HALF PRICE

Technique Certificat d'assistance et de garantie électronique
www.vevor.com/support

VEVOR[®]

TOUGH TOOLS, HALF PRICE

Technisch Support und E-Garantie-Zertifikat

www.vevor.com/support

RAUMTEILER AUS STOFF

Benutzerhandbuch

PFDMFGHS01

PFDMFGSH02

PFDMFGMS03

Wir sind weiterhin bestrebt, Ihnen Werkzeuge zu wettbewerbsfähigen Preisen anzubieten.

"Sparen Sie die Hälfte", "Halber Preis" oder andere ähnliche Ausdrücke, die wir nur verwenden

stellt eine Schätzung der Einsparungen dar, die Sie durch den Kauf bestimmter Werkzeuge erzielen können

mit uns im Vergleich zu den großen Top-Marken und bedeutet nicht unbedingt, Abdeckung alle von uns angebotenen Werkzeugkategorien. Wir möchten Sie bitten, zu überprüfen sorgfältig

wenn Sie bei uns eine Bestellung aufgeben, wenn Sie tatsächlich Speichern

Hälfte im Vergleich mit den Top-Großmarken.

VEVOR®

TOUGH TOOLS, HALF PRICE

FABRIC ROOM DIVIDE

PFDMFGHS01

PFDMFGSH02

PFDMFGMS03

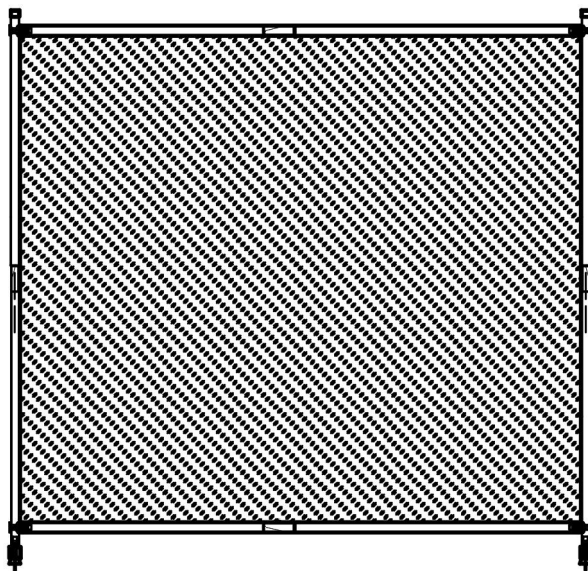

Brauchen Sie Hilfe? Kontaktieren Sie uns!

Sie haben Fragen zu unseren Produkten? Sie benötigen technischen Support? Dann kontaktieren Sie uns gerne:

Technischer Support und E-Garantie-Zertifikat

www.vevor.com/support

Dies ist die Originalanleitung. Bitte lesen Sie alle Anweisungen sorgfältig durch, bevor Sie das Gerät in Betrieb nehmen. VEVOR behält sich eine klare Auslegung unserer Bedienungsanleitung vor. Das Erscheinungsbild des Produkts richtet sich nach dem Produkt, das Sie erhalten haben. Bitte verzeihen Sie uns, dass wir Sie nicht erneut informieren, wenn es Technologie- oder Software-Updates für unser Produkt gibt .

SAFETY INSTRUCTIONS

WARNUNG:

Lesen Sie dieses Material, bevor Sie dieses Produkt verwenden. Andernfalls kann es zu schweren Verletzungen kommen.

Vorsichtsmaßnahmen bei der Montage

17. Führen Sie die Montage nur gemäß dieser Anleitung durch. Eine unsachgemäße Montage kann zu Gefahren führen.
18. Tragen Sie während der Montage eine ANSI-geprüfte Schutzbrille und robuste Arbeitshandschuhe.
19. Halten Sie den Versammlungsbereich sauber und gut beleuchtet.
20. Halten Sie während der Montage unbeteiligte Zuschauer vom Bereich fern.
21. Nicht zusammenbauen, wenn Sie müde sind oder unter Einfluss von Alkohol, Drogen oder Medikamenten stehen.
22. Die Produktfunktionen gelten nur für ordnungsgemäß und vollständig montierte Produkte.
23. Montieren Sie es auf einer flachen, ebenen, harten und glatten Oberfläche, die die Stoff-Raumteiler sicher tragen kann.
24. Weitere Informationen zu den auf den folgenden Seiten aufgeführten Teilen finden Sie im Montagediagramm dieses Handbuchs. Packen Sie alle Teile in einem sauberen Arbeitsbereich aus und trennen Sie sie.









Vorsichtsmaßnahmen treffen

13. SETZEN ODER STELLEN SIE SICH NICHT AUF DIESEN GEGENSTAND.
14. Dieses Produkt ist kein Spielzeug. Erlauben Sie Kindern nicht, mit oder in der Nähe dieses Artikels zu spielen.
15. Überschreiten Sie nicht die angegebenen Gewichtskapazitäten.
16. Nur auf einer flachen, ebenen, harten und glatten Oberfläche verwenden, die eine voll beladene Raumteiler aus Stoff sicher tragen kann.
17. Nur bestimmungsgemäß verwenden.

18. Vor jedem Gebrauch prüfen; nicht verwenden, wenn Teile lose oder beschädigt sind.

BEWAHREN SIE DIESES HANDBUCH AUF

PARTS LIST

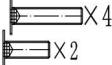
| | | |
|-----|---|------------|
| A |  | 2 |
| B |  | 2 |
| C |  | 2 |
| D |  | 2 |
| E |  | 2 |
| F |  | 1 |
| G |  | 1 |
| H |  | 1 |
| ICH |  | Vorgeladen |

HINWEIS : Bei Zubehör F handelt es sich um Ersatzschrauben als Geschenk; H ist der Stoff des Bildschirms. Achten Sie darauf, dass er bei der Installation nicht schmutzig wird.

ASSEMBLY STEP

SCHRITT 1

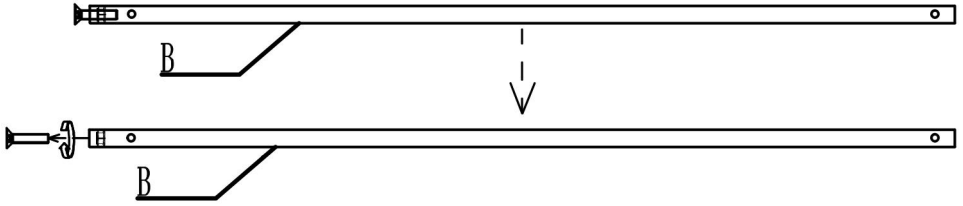

Unscrew from material B and set aside.

X2

SCHRITT 2

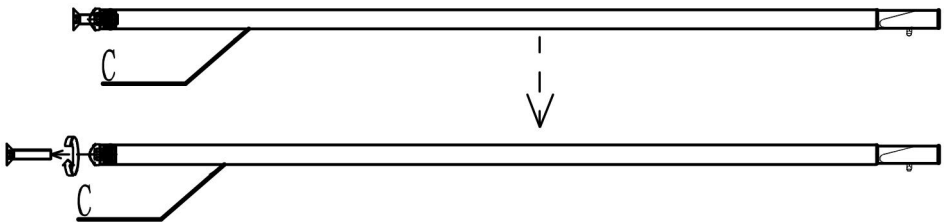

Unscrew from material C and set aside.

X2

SCHRITT 3

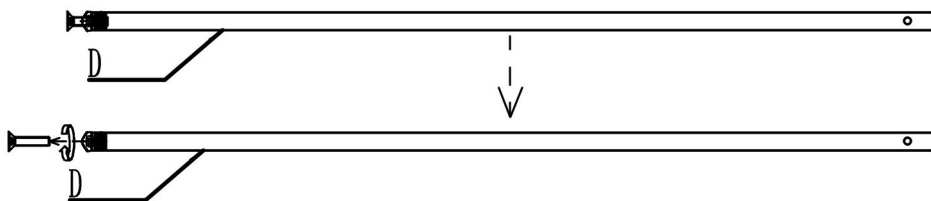

Unscrew from material D and set aside.

X2

SCHRITT 4

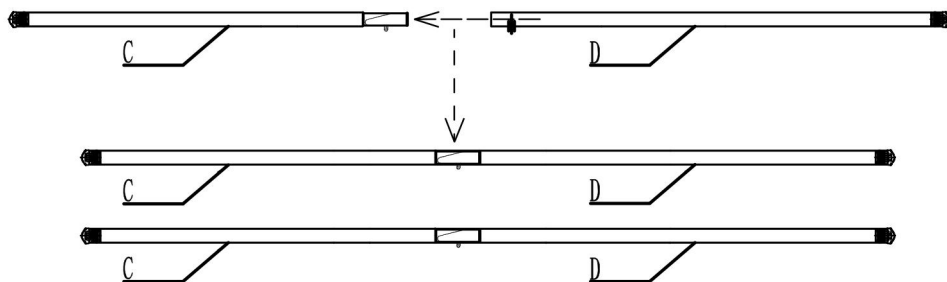

Connect material C with material D, 2 in total.

SCHRITT 5

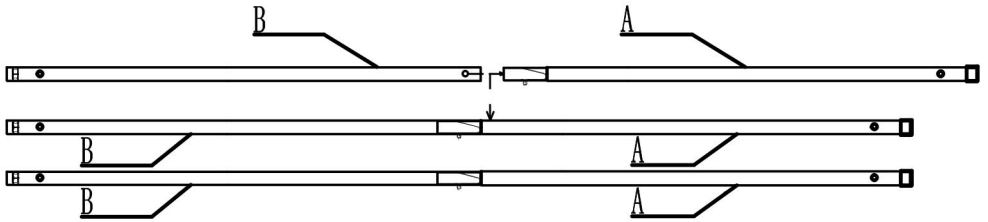

Connect material B with material A, 2 in total.

SCHRITT 6

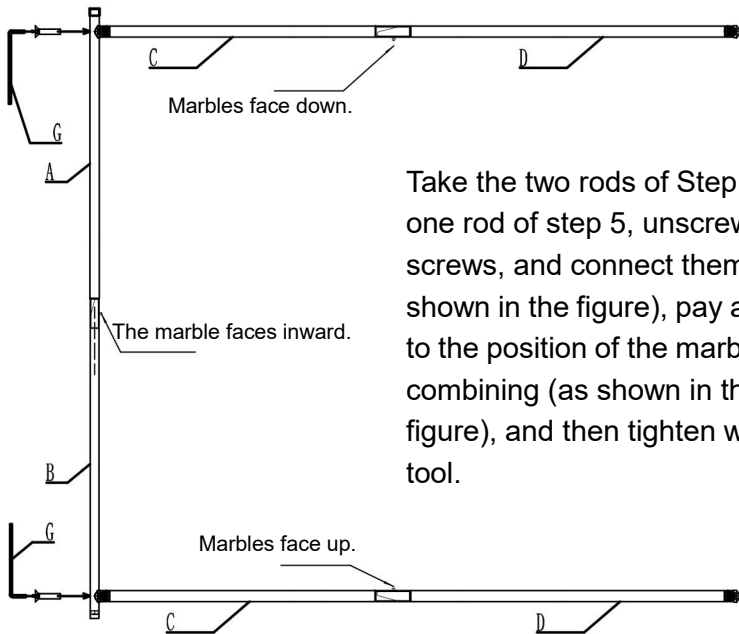

Take the two rods of Step 4 and one rod of step 5, unscrew the screws, and connect them (as shown in the figure), pay attention to the position of the marble when combining (as shown in the figure), and then tighten with G tool.

SCHRITT 7

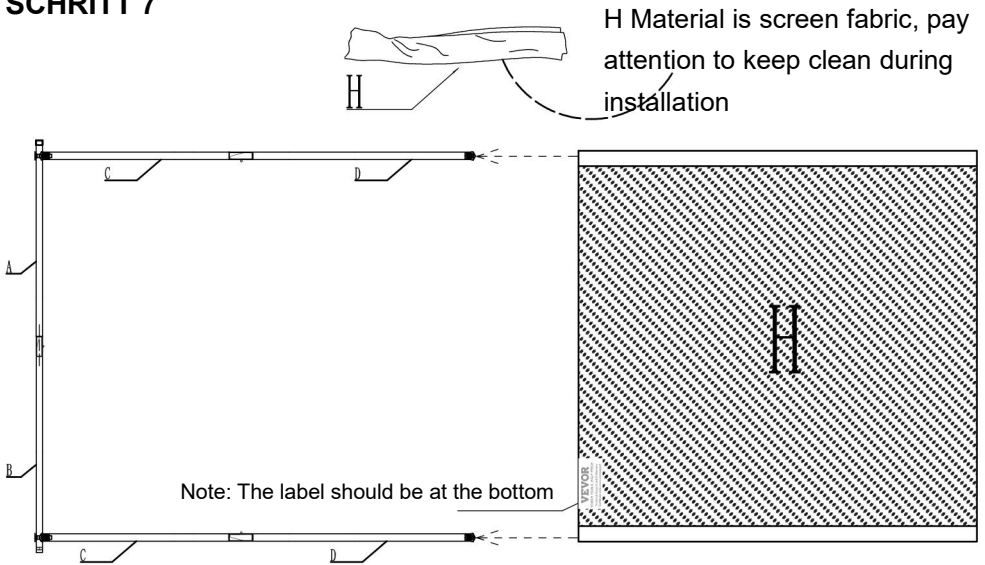

Insert the sleeve of material H into the upper and lower cross bars.

SCHRITT 8

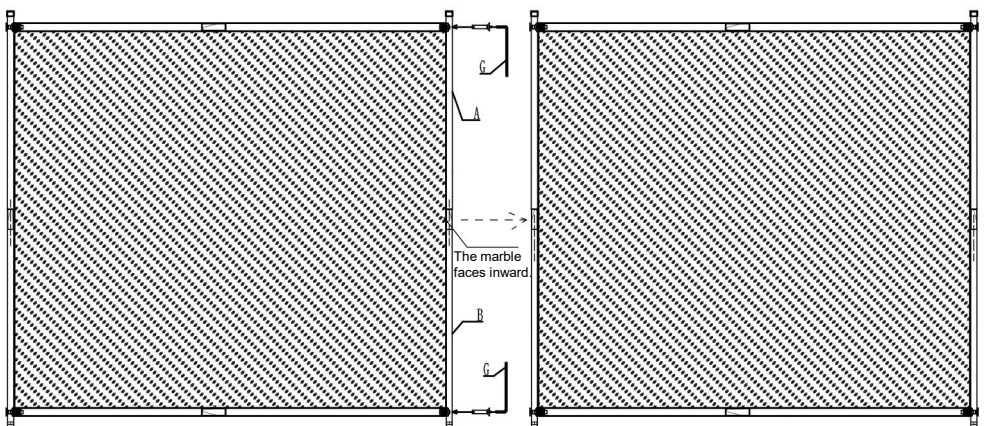

Take the other combined pipe in Step 5 and assemble it in the frame of Step 7, pay attention to the screw that is unscrewed first, and then connect and tighten it (as shown in the figure), pay attention to the position of the marble when assembling it (as shown in the figure), and then tighten it with the G tool.

SCHRITT 9

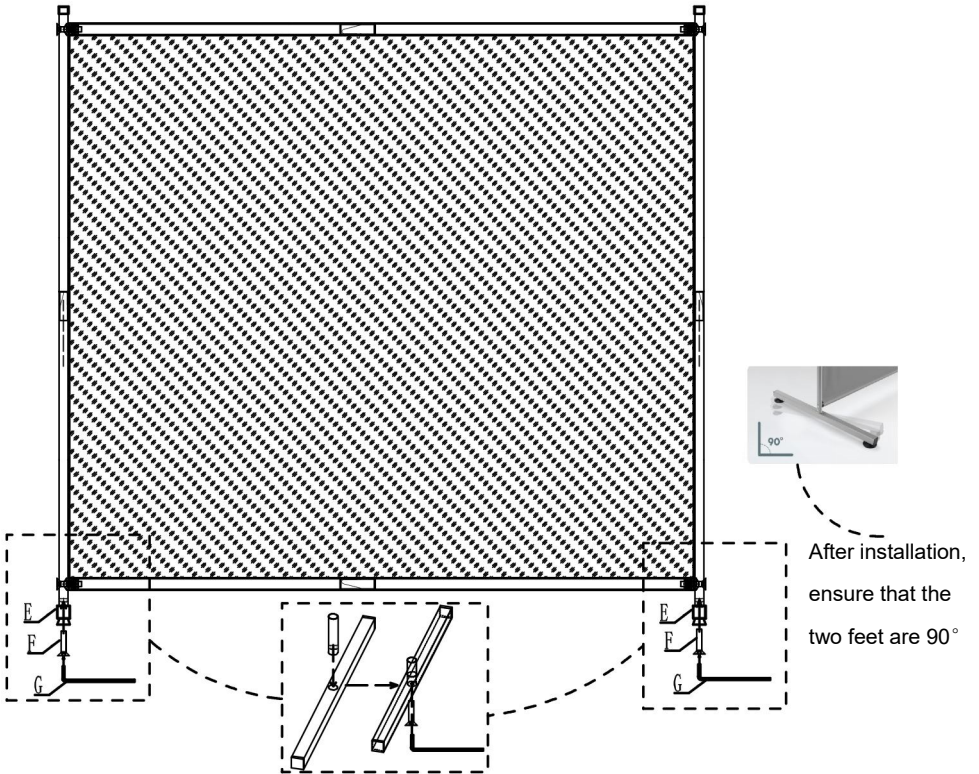

Assemble 2 pieces of material E into the frame in step 8;

Note: In order to make the whole shelf more stable, when installing the foot, first insert the pipe into the foot, then through the unscrewed screw, and then connect, and tighten with the G tool

SCHRITT 10

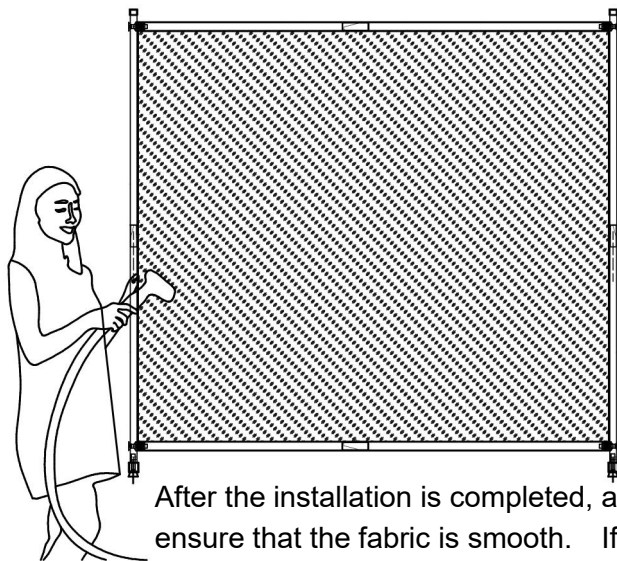

After the installation is completed, arrange the fabric to ensure that the fabric is smooth. If the fabric has wrinkles, you can use a household hanging press to iron it.

SCHRITT 11

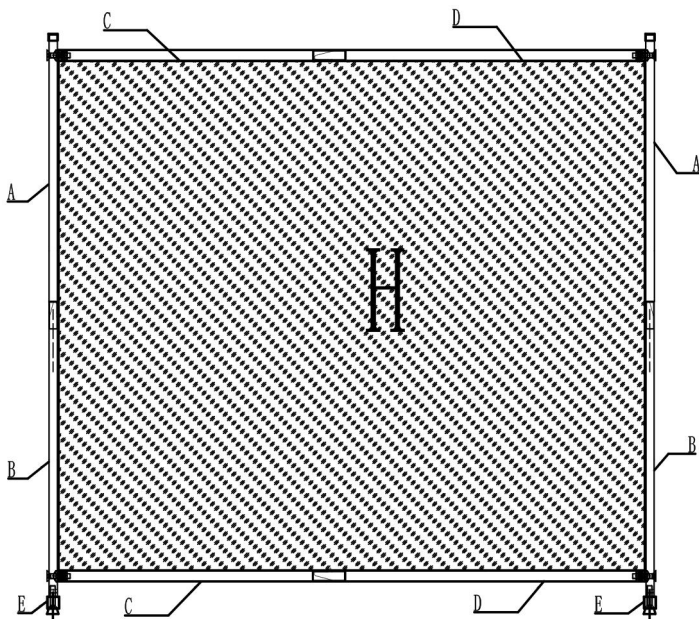

PRODUCT PARAMETER

| Modell | PFDMFGHS01 | PFDMFGSH02 | PFDMFGMS03 |
|-------------------|----------------------|------------|--------------|
| Farbe | Schwarz | Grau | Cremerfarben |
| Anzahl der Panels | 1 | | |
| Produktgröße | 1810 x 1815 x 500 mm | | |

Hersteller: Shanghaimuxinmuyeyouxiangongsi

Adresse: Shuangchenglu 803nong11hao1602A-1609shi, baoshanqu, Shanghai, 200.000 CN.

Nach AUS importiert: SIHAO PTY LTD. 1 ROKEVA
STREETEASTWOOD
NSW 2122 Australien

Importiert in die USA: Sanven Technology Ltd. Suite 250, 9166 Anaheim
Ort, Rancho Cucamonga, CA 91730

| | |
|-----------|------------|
| UK | REP |
|-----------|------------|

YH CONSULTING LIMITED. C/O YH Consulting
Limited Office 147, Centurion House, London
Road, Staines-upon-Thames, Surrey, TW18 4AX

| | |
|-----------|------------|
| EC | REP |
|-----------|------------|

E-CrossStu GmbH
Mainzer Landstr.69,
60329 Frankfurt am Main.

VEVOR[®]

TOUGH TOOLS, HALF PRICE

Technisch Support und E-Garantie-Zertifikat
www.vevor.com/support

VEVOR®

TOUGH TOOLS, HALF PRICE

Tecnico Supporto e certificato di garanzia elettronica

www.vevor.com/support

DIVISORIO IN TESSUTO

MANUALE D' uso

PFDMFGHS01

PFDMGSH02

PFDMGMS03

Continuiamo a impegnarci per fornirvi strumenti a prezzi competitivi.

"Risparmia la metà", "Metà prezzo" o altre espressioni simili utilizzate solo da noi rappresenta una stima dei risparmi che potresti ottenere acquistando determinati strumenti con noi rispetto ai principali marchi top e non significa necessariamente copertina tutte le categorie di strumenti da noi offerti. Ti ricordiamo cortesemente di verificare accuratamente

quando effettui un ordine con noi se sei effettivamente Risparmio
Metà rispetto ai marchi più importanti.

VEVOR®

TOUGH TOOLS, HALF PRICE

FABRIC ROOM DIVIDE

PDFDMFGHS01 PDFDMGSH02 PDFDMGMS03

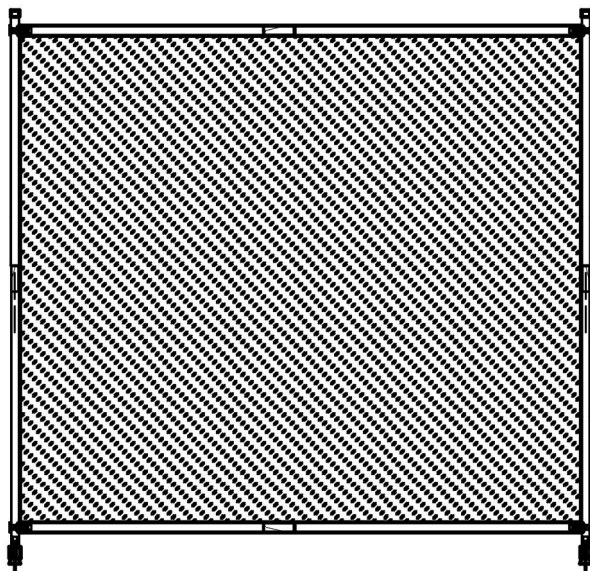

HAI BISOGNO DI AIUTO? CONTATTACI!

Hai domande sui prodotti? Hai bisogno di supporto tecnico? Non esitare a contattarci:

Supporto tecnico e certificato di garanzia elettronica
www.vevor.com/support

Questa è l'istruzione originale, si prega di leggere attentamente tutte le istruzioni del manuale prima di utilizzare. VEVOR si riserva una chiara interpretazione del nostro manuale utente. L'aspetto del prodotto sarà soggetto al prodotto ricevuto. Vi preghiamo di perdonarci se non vi informeremo di nuovo se ci sono aggiornamenti tecnologici o software sul nostro prodotto.

SAFETY INSTRUCTIONS

AVVERTIMENTO:

Leggere questo materiale prima di utilizzare questo prodotto. La mancata osservanza di questa precauzione può causare gravi lesioni.

Precauzioni di montaggio









25. Montare solo secondo queste istruzioni. Un montaggio improprio può creare pericoli.
26. Durante il montaggio, indossare occhiali di sicurezza omologati ANSI e guanti da lavoro resistenti.
27. Mantenere l'area di riunione pulita e ben illuminata.
28. Durante l'assemblea, tenere gli astanti lontani dall'area.
29. Non riunirsi se si è stanchi o sotto l'effetto di alcol, droghe o farmaci.
30. Le capacità del prodotto si applicano solo ai prodotti correttamente e completamente assemblati.
31. Montare su una superficie piana, livellata, dura e liscia, in grado di sostenere in modo sicuro il divisorio in tessuto.
32. Per ulteriori informazioni sulle parti elencate nelle pagine seguenti, fare riferimento allo schema di montaggio di questo manuale. Disimballare e separare tutte le parti in un'area di lavoro pulita.

Usare precauzioni

19. **NON SEDERSI O STARE IN PIEDI SU QUESTO OGGETTO.**
20. Questo prodotto non è un giocattolo. Non permettere ai bambini di giocare con o vicino a questo articolo.
21. Non superare i limiti specificati capacità di peso.
22. Utilizzare solo su una superficie piana, livellata, dura e liscia in grado di sostenere in modo sicuro un divisorio in tessuto completamente carico.
23. Utilizzare solo come previsto.
24. Ispezionare prima di ogni utilizzo; non utilizzare se alcune parti risultano allentate o danneggiate.

SALVA QUESTO MANUALE

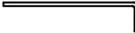
PARTS LIST

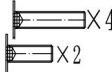
| | | |
|----|--|-------------------|
| UN |  | 2 |
| B |  | 2 |
| C |  | 2 |
| D |  | 2 |
| E |  | 2 |
| F |  | 1 |
| G |  | 1 |
| H |  | 1 |
| IO |  X4 X2 | Pre ricaricato |

NOTA : gli accessori F sono viti di ricambio in regalo; H è il tessuto dello schermo, fare attenzione a non sporcarlo durante l'installazione.

ASSEMBLY STEP

PASSO 1

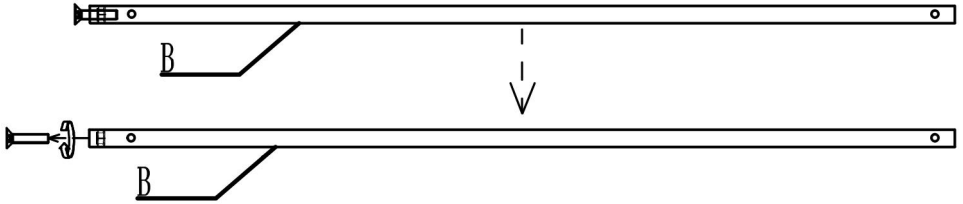

Unscrew from material B and set aside.

X2

PASSO 2

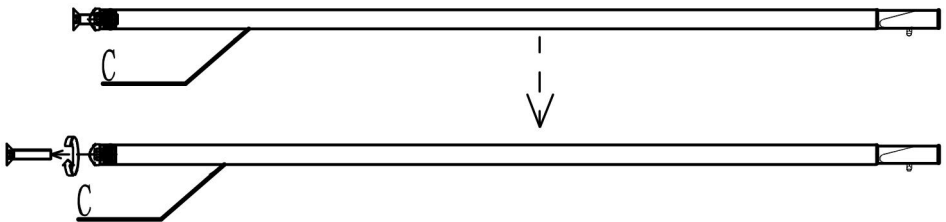

Unscrew from material C and set aside.

X2

PASSO 3

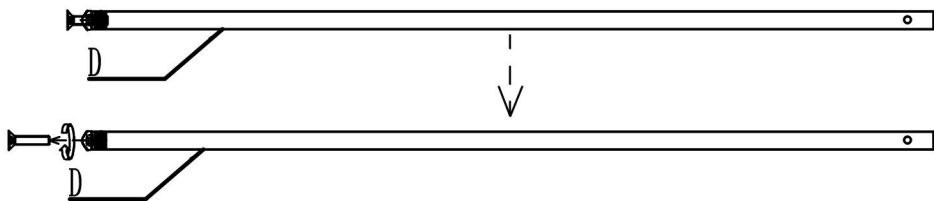

Unscrew from material D and set aside.

X2

PASSO 4

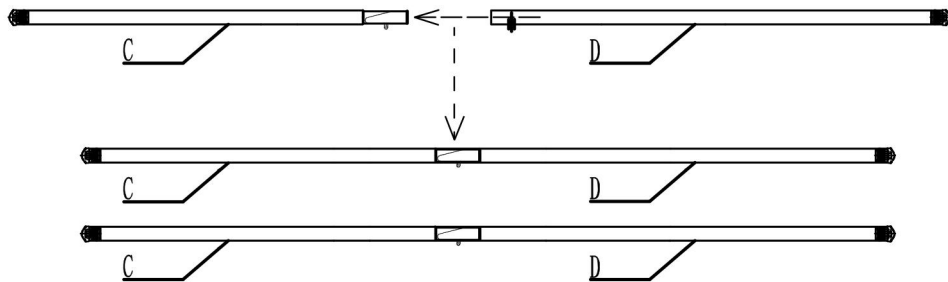

Connect material C with material D, 2 in total.

PASSO 5

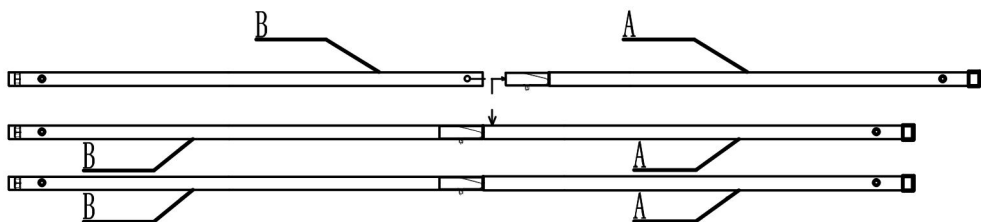

Connect material B with material A, 2 in total.

PASSO 6

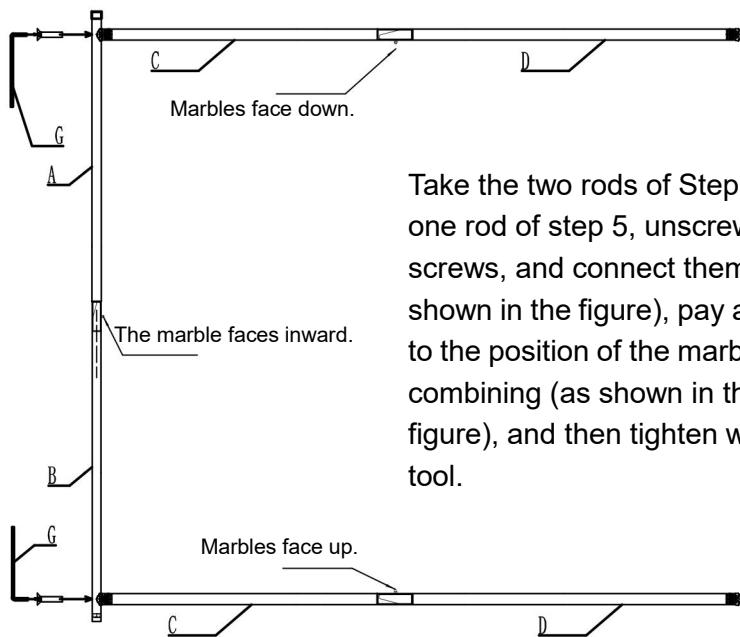

Take the two rods of Step 4 and one rod of step 5, unscrew the screws, and connect them (as shown in the figure), pay attention to the position of the marble when combining (as shown in the figure), and then tighten with G tool.

PASSO 7

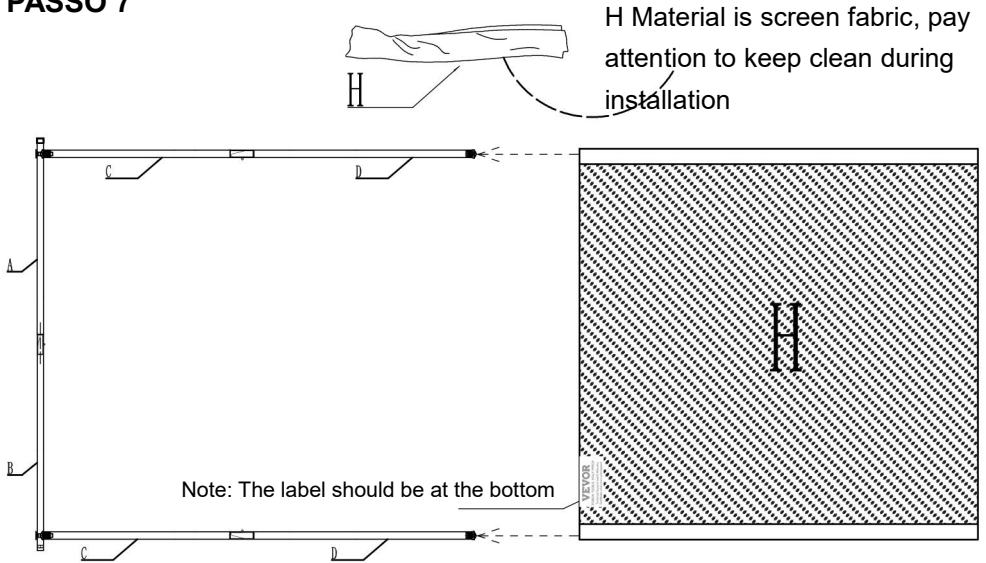

Insert the sleeve of material H into the upper and lower cross bars.

PASSO 8

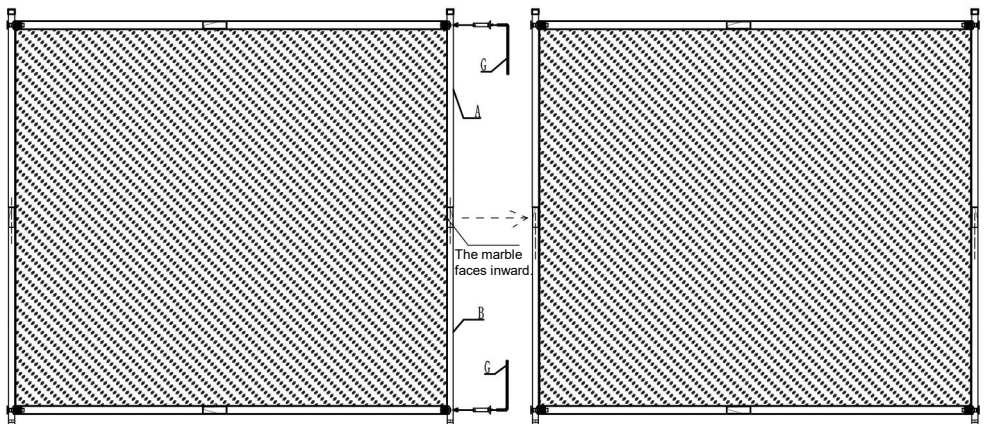

Take the other combined pipe in Step 5 and assemble it in the frame of Step 7, pay attention to the screw that is unscrewed first, and then connect and tighten it (as shown in the figure), pay attention to the position of the marble when assembling it (as shown in the figure), and then tighten it with the G tool.

PASSO 9

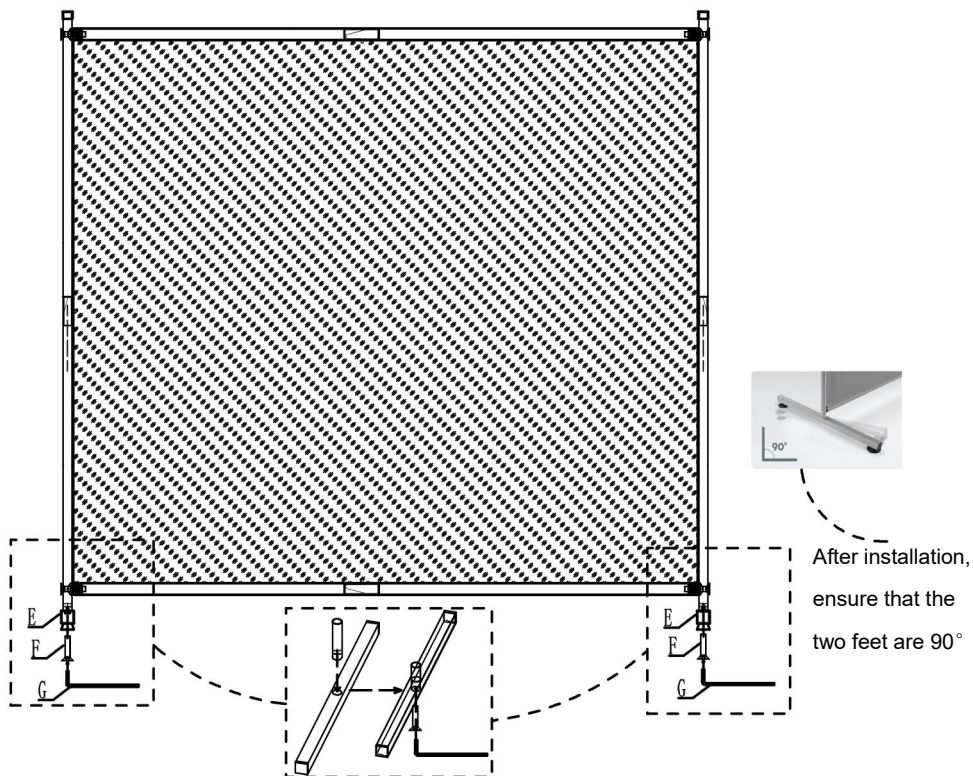

Assemble 2 pieces of material E into the frame in step 8;

Note: In order to make the whole shelf more stable, when installing the foot, first insert the pipe into the foot, then through the unscrewed screw, and then connect, and tighten with the G tool

PASSO 10

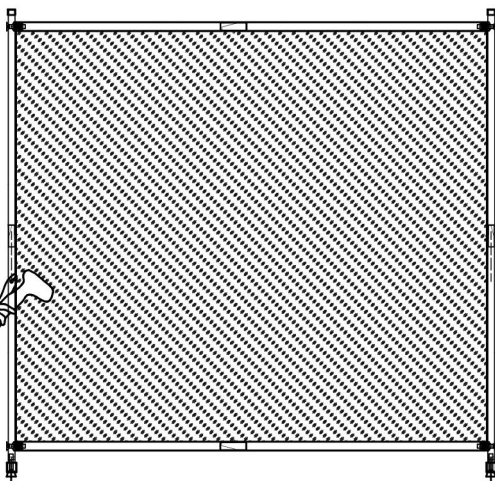

After the installation is completed, arrange the fabric to ensure that the fabric is smooth. If the fabric has wrinkles, you can use a household hanging press to iron it.

PASSO 11

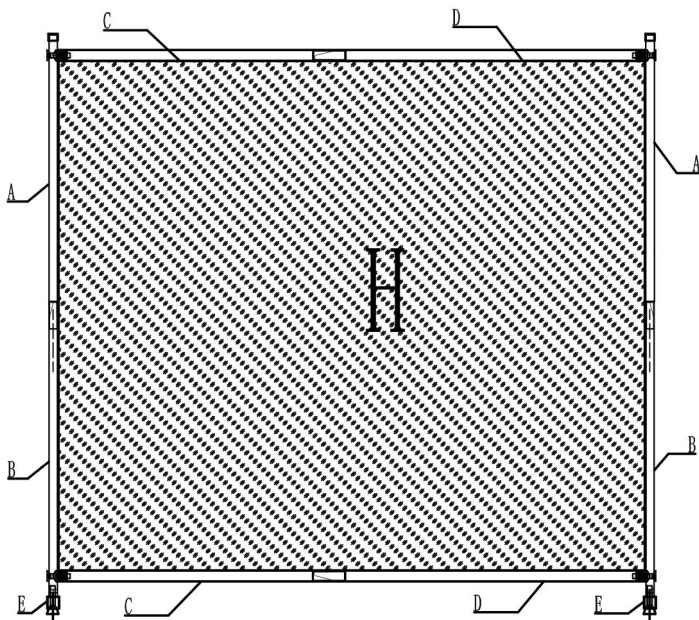

PRODUCT PARAMETER

| Modello | PFDMFGHS01 | PFDMGSH02 | PFDMGMS03 |
|-------------------------|-----------------|-----------|-------------|
| Colore | Nero | Grigio | C ome crema |
| Numero di pannelli | 1 | | |
| Dimensioni del prodotto | 1810*1815*500mm | | |

Produttore: Shanghai muxinmuyeyouxiangongsi

Indirizzo: Shuangchenglu 803nong11hao1602A-1609shi, baoshanqu, shanghai 200000 CN.

Importato in AUS: SIHAO PTY LTD. 1 ROKEVA STREET EASTWOOD
Nuovo Galles del Sud 2122 Australia

Importato negli USA: Sanven Technology Ltd. Suite 250, 9166 Anaheim
Luogo, Rancho Cucamonga, CA 91730

| | |
|-----------|------------|
| UK | REP |
|-----------|------------|

YH CONSULTING LIMITED. C/O YH Consulting
Limited Office 147, Centurion House, London
Road, Staines-upon-Thames, Surrey, TW18 4AX

| | |
|-----------|------------|
| EC | REP |
|-----------|------------|

E-CrossStu GmbH
Mainzer Landstr.69,
60329 Frankfurt am Main.

VEVOR[®]

TOUGH TOOLS, HALF PRICE

Tecnico Supporto e certificato di garanzia elettronica
www.vevor.com/support

VEVOR[®]

TOUGH TOOLS, HALF PRICE

Técnico Certificado de soporte y garantía electrónica

www.vevor.com/support

DIVIDIR HABITACIÓN CON TELA de USUARIO

PFDMFGHS01

PFDMFGSH02

PFDMFGMS03

Seguimos comprometidos a brindarle herramientas a precios competitivos. "Ahorra la mitad", "mitad de precio" o cualquier otra expresión similar utilizada únicamente por nosotros

Representa una estimación de los ahorros que podría obtener al comprar ciertas herramientas.

con nosotros en comparación con las principales marcas líderes y no significa necesariamente cubrir

Todas las categorías de herramientas que ofrecemos. Le recordamos que debe verificar con cuidado

Cuando realiza un pedido con nosotros, si realmente está Ahorro Medio en comparación con las principales marcas líderes.

VEVOR®

TOUGH TOOLS, HALF PRICE

FABRIC ROOM DIVIDE

PFDMFGHS01

PFDMFGSH02

PFDMFGMS03

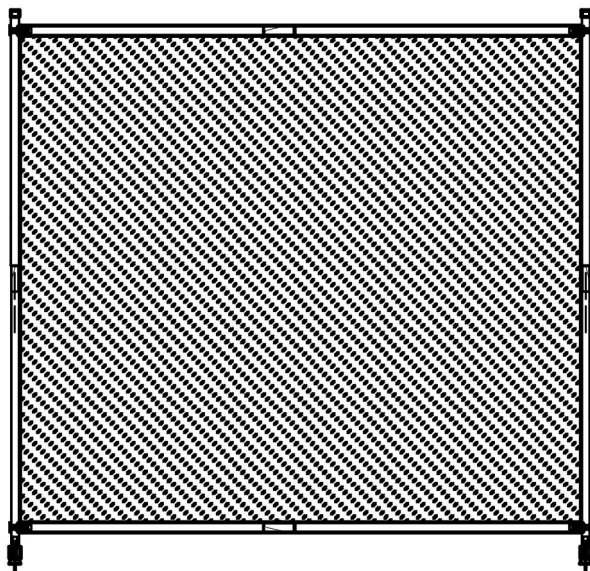

¿NECESITAS AYUDA? ¡CONTÁCTANOS!

¿Tiene preguntas sobre el producto? ¿Necesita asistencia técnica? No dude en ponerse en contacto con nosotros:

Soporte técnico y certificado de garantía electrónica

www.vevor.com/support

Estas son las instrucciones originales, lea atentamente todas las instrucciones del manual antes de utilizar el producto. VEVOR se reserva una interpretación clara de nuestro manual de usuario. La apariencia del producto estará sujeta al producto que recibió. Perdónenos por no informarle nuevamente si hay actualizaciones de tecnología o software en nuestro producto.

SAFETY INSTRUCTIONS

ADVERTENCIA:

Lea este material antes de utilizar este producto. No hacerlo puede provocar lesiones graves.

Precauciones de montaje

33. Realice el montaje únicamente de acuerdo con estas instrucciones. Un montaje inadecuado puede generar peligros.
34. Use gafas de seguridad aprobadas por ANSI y guantes de trabajo resistentes durante el montaje.
35. Mantenga el área de reunión limpia y bien iluminada.
36. Mantenga a los transeúntes fuera del área durante el montaje.
37. No se reúna si está cansado o bajo la influencia del alcohol, drogas o medicamentos.
38. Las capacidades del producto se aplican únicamente a productos ensamblados de forma correcta y completa.
39. Móntelo sobre una superficie plana, nivelada, dura y lisa capaz de soportar de forma segura el divisor de ambientes de tela.
40. Para obtener información adicional sobre las piezas que se enumeran en las páginas siguientes, consulte el diagrama de ensamblaje de este manual. Desembale y separe todas las piezas en un área de trabajo limpia.









Tome precauciones

25. NO SE SIENTA NI SE PARE SOBRE ESTE ARTÍCULO.
26. Este producto no es un juguete. No permita que los niños jueguen con este artículo ni cerca de él.
27. No exceda lo especificado Capacidades de peso.
28. Úselo únicamente sobre una superficie plana, nivelada, dura y lisa que pueda soportar de manera segura un divisor de ambientes de tela completamente cargado.
29. Úselo únicamente según lo previsto.
30. Inspeccione antes de cada uso; no utilice si las piezas están sueltas o

dañadas.

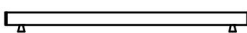
GUARDE ESTE MANUAL

PARTS LIST

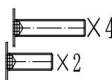
| | | |
|-------|---|----------------|
| A |  | 2 |
| B |  | 2 |
| do |  | 2 |
| D |  | 2 |
| mi |  | 2 |
| F |  | 1 |
| GRAMO |  | 1 |
| yo |  | 1 |
| I |  X4 X2 | P recargado |

NOTA : Los accesorios F son tornillos de repuesto para regalo; H es la tela de la pantalla, preste atención para no ensuciarse durante la instalación.

ASSEMBLY STEP

PASO 1

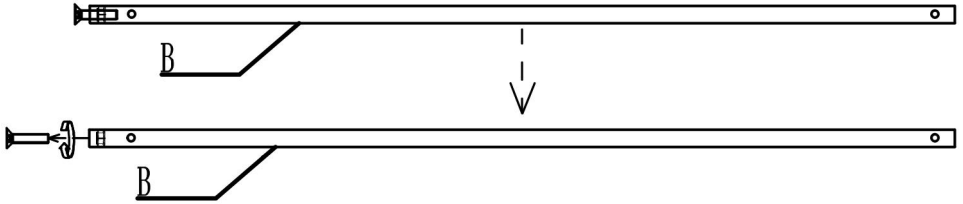

Unscrew from material B and set aside.

X2

PASO 2

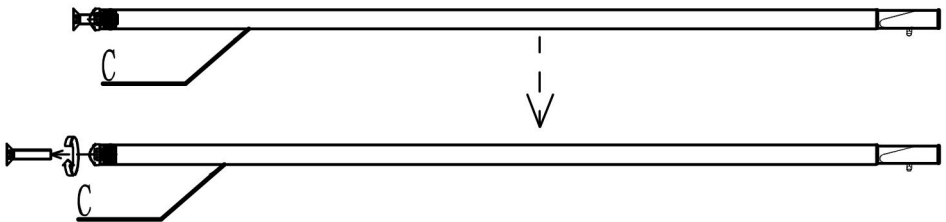

Unscrew from material C and set aside.

X2

PASO 3

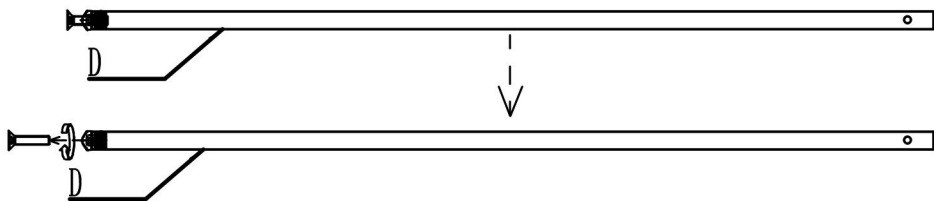

Unscrew from material D and set aside.

X2

PASO 4

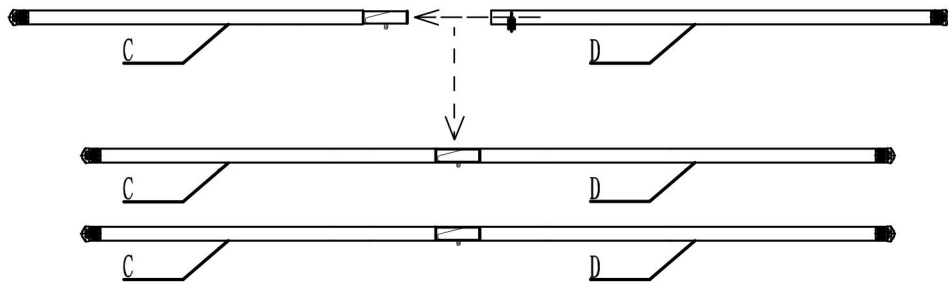

Connect material C with material D, 2 in total.

PASO 5

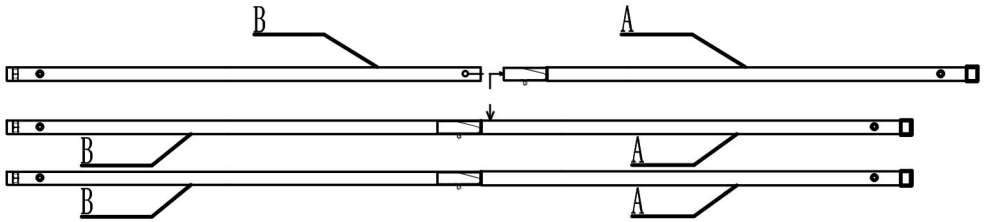

Connect material B with material A, 2 in total.

PASO 6

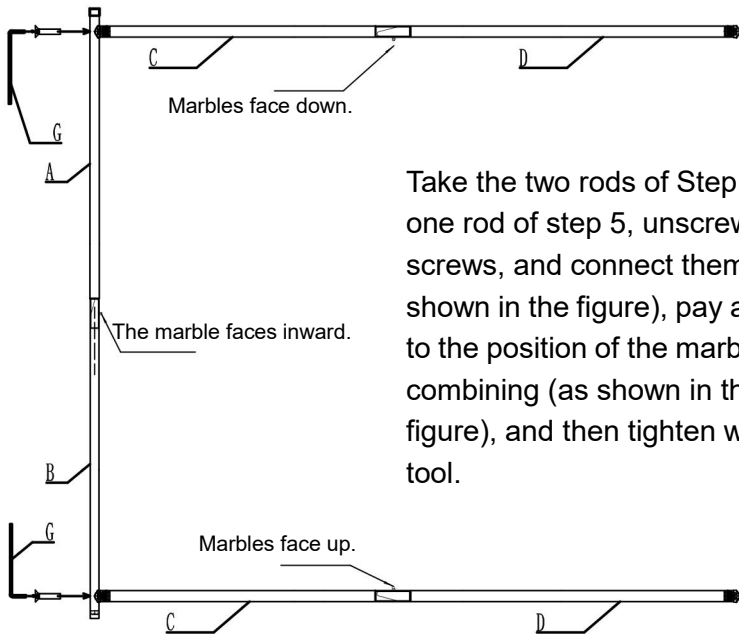

Take the two rods of Step 4 and one rod of step 5, unscrew the screws, and connect them (as shown in the figure), pay attention to the position of the marble when combining (as shown in the figure), and then tighten with G tool.

PASO 7

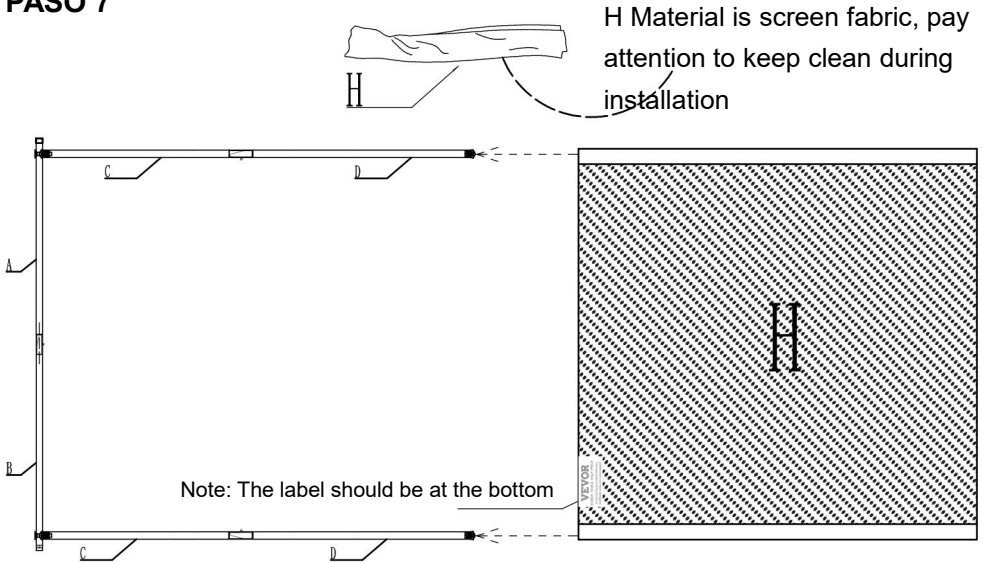

Insert the sleeve of material H into the upper and lower cross bars.

PASO 8

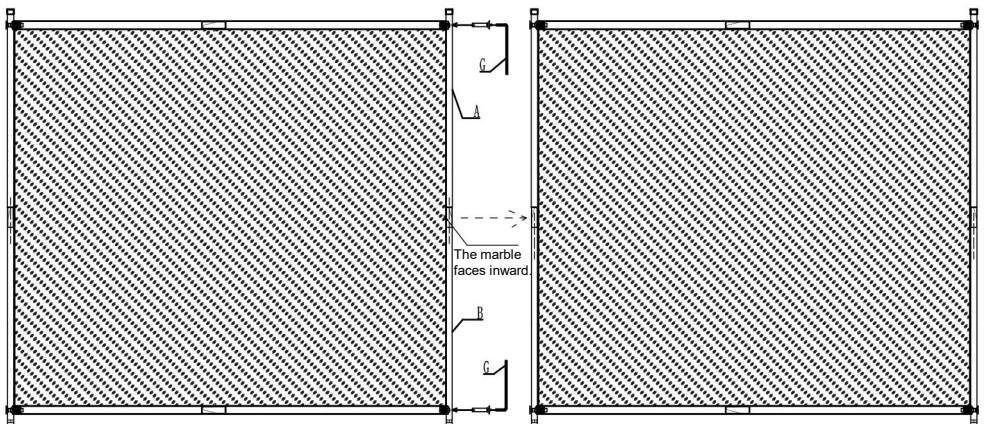

Take the other combined pipe in Step 5 and assemble it in the frame of Step 7, pay attention to the screw that is unscrewed first, and then connect and tighten it (as shown in the figure), pay attention to the position of the marble when assembling it (as shown in the figure), and then tighten it with the G tool.

PASO 9

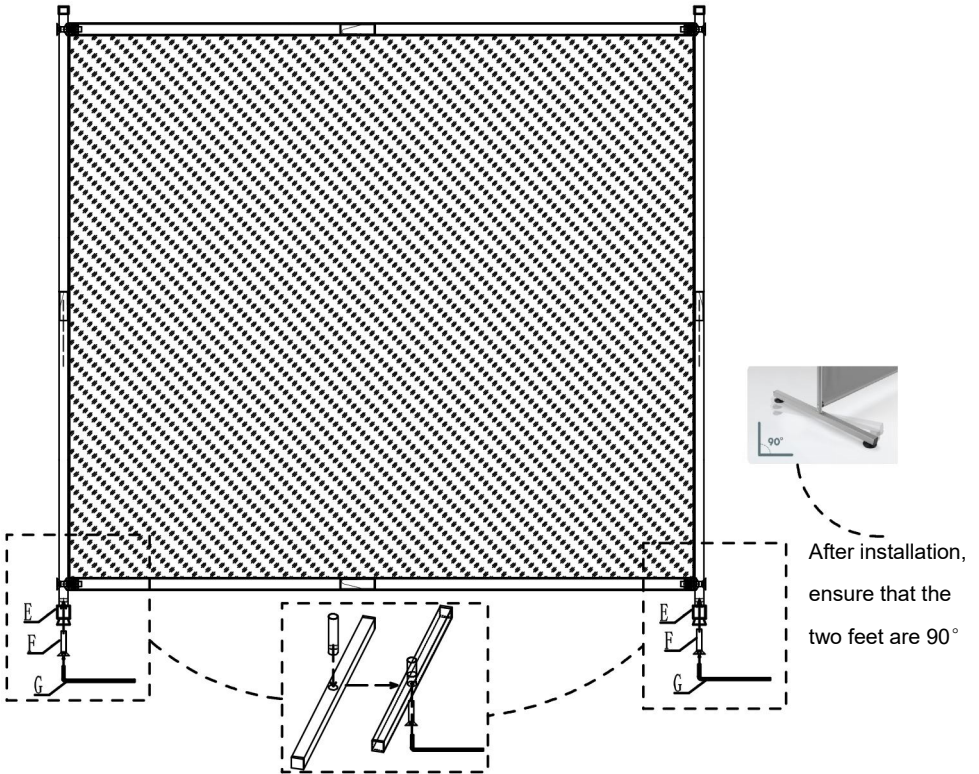

Assemble 2 pieces of material E into the frame in step 8;

Note: In order to make the whole shelf more stable, when installing the foot, first insert the pipe into the foot, then through the unscrewed screw, and then connect, and tighten with the G tool

PASO 10

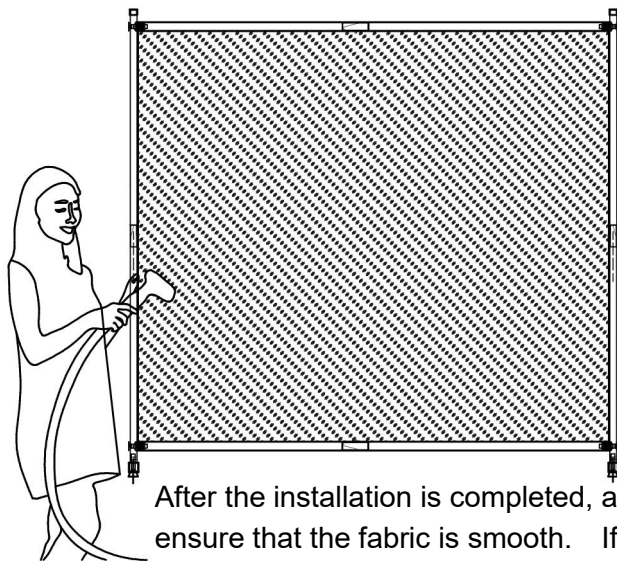

After the installation is completed, arrange the fabric to ensure that the fabric is smooth. If the fabric has wrinkles, you can use a household hanging press to iron it.

PASO 11

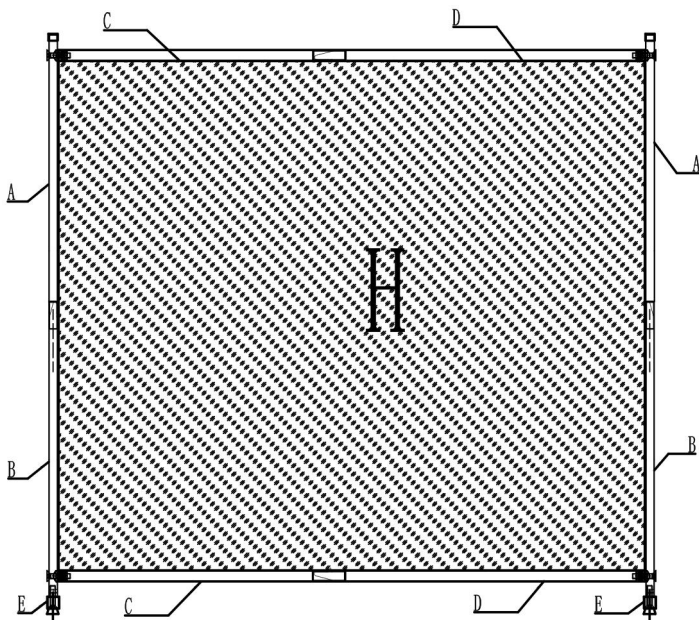

PRODUCT PARAMETER

| Modelo | PFDMSGHS01 | PFDMSGSH02 | PFDMSGMS03 |
|---------------------|------------------|------------|---------------|
| Color | Negro | Gris | C rema- Color |
| Número de paneles | 1 | | |
| Tamaño del producto | 1810*1815*500 mm | | |

Fabricante: Shanghaimuxinmuyeyouxiangongsi

Dirección: Shuangchenglu 803nong11hao1602A-1609shi, baoshanqu, Shangai 200000 CN.

Importado a Australia: SIHAO PTY LTD. 1 ROKEVA STREETEASTWOOD

Nueva Gales del Sur 2122 Australia

Importado a EE. UU.: Sanven Technology Ltd. Suite 250, 9166 Anaheim Lugar, Rancho Cucamonga, CA 91730

| | |
|-----------|------------|
| UK | REP |
|-----------|------------|

YH CONSULTING LIMITED. C/O YH Consulting
Limited Office 147, Centurion House, London
Road, Staines-upon-Thames, Surrey, TW18 4AX

| | |
|-----------|------------|
| EC | REP |
|-----------|------------|

E-CrossStu GmbH
Mainzer Landstr.69,
60329 Frankfurt am Main.

VEVOR[®]

TOUGH TOOLS, HALF PRICE

Técnico Certificado de soporte y garantía electrónica

www.vevor.com/support

VEVOR®

TOUGH TOOLS, HALF PRICE

Techniczny Wsparcie i certyfikat e-gwarancji

www.vevor.com/support

PRZEGRODA POKOJU Z TKANINY

INSTRUKCJA obsługi

PFDMFGHS01

PFDMFGSH02

PFDMFGMS03

Nadal staramy się oferować Państwu narzędzia w konkurencyjnych cenach. „Oszczędź połowę”, „Połowa ceny” lub jakiegokolwiek inne podobne wyrażenia używane wyłącznie przez nas przedstawia szacunkowe oszczędności, jakie możesz uzyskać kupując określone narzędzia z nami w porównaniu do głównych, najlepszych marek i niekoniecznie oznacza to okładka wszystkie kategorie narzędzi oferowanych przez nas. Przypominamy o sprawdzeniu ostrożnie gdy składasz u nas zamówienie, jeśli faktycznie Oszczędność Połowa w porównaniu z wiodącymi markami.

VEVOR[®]

TOUGH TOOLS, HALF PRICE

FABRIC ROOM DIVIDE

PFDMFGHS01

PFDMFGSH02

PFDMFGMS03

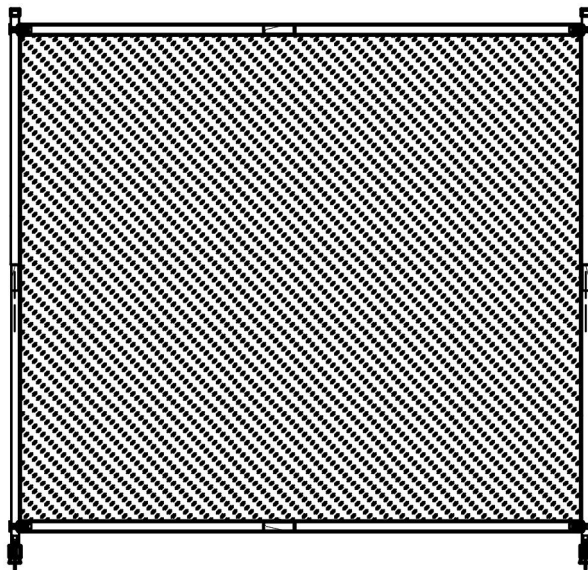

POTRZEBUJESZ POMOCY? SKONTAKTUJ SIĘ Z NAMI!

Masz pytania dotyczące produktu? Potrzebujesz wsparcia technicznego? Skontaktuj się z nami:

Wsparcie techniczne i certyfikat e-gwarancji
www.vevor.com/support

To jest oryginalna instrukcja, przed użyciem należy uważnie przeczytać wszystkie instrukcje. VEVOR zastrzega sobie jasną interpretację naszej instrukcji obsługi. Wygląd produktu będzie zależał od produktu, który otrzymałeś. Prosimy o wybaczenie, że nie poinformujemy Cię ponownie, jeśli w naszym produkcie pojawią się jakiegokolwiek aktualizacje technologiczne lub oprogramowania.

SAFETY INSTRUCTIONS

OSTRZEŻENIE:

Przeczytaj ten materiał przed użyciem tego produktu.

Nieprzestrzeżenie tego może spowodować poważne obrażenia.

Środki ostrożności podczas montażu

41. Montaż należy wykonywać wyłącznie zgodnie z niniejszą instrukcją. Nieprawidłowy montaż może stwarzać zagrożenia.
42. Podczas montażu należy nosić okulary ochronne z atestem ANSI oraz wytrzymałe rękawice robocze.
43. Utrzymuj miejsce zgromadzenia w czystości i zapewnij dobre oświetlenie.
44. Nie dopuszczaj osób postronnych na teren montażu podczas jego trwania.
45. Nie przychodź na spotkanie, jeśli jesteś zmęczony lub znajdujesz się pod wpływem alkoholu, narkotyków lub leków.
46. Możliwości produktu odnoszą się wyłącznie do produktów prawidłowo i kompletnie zmontowanych.
47. Zamontuj na płaskiej, równej, twardej i gładkiej powierzchni, która będzie w stanie bezpiecznie utrzymać ściankę działową Fabric Room Divide.
48. Aby uzyskać dodatkowe informacje dotyczące części wymienionych na kolejnych stronach, zapoznaj się ze schematem montażu w tym podręczniku. Rozpakuj i oddziel wszystkie części w czystym miejscu pracy.

Stosuj środki ostrożności









31. NIE SIADAĆ ANI NIE STAWAĆ NA TYM PRZEDMIOCIE.
32. Ten produkt nie jest zabawką. Nie pozwalaj dzieciom bawić się tym przedmiotem ani przebywać w jego pobliżu.
33. Nie przekraczać określonej nośności.
34. Stosować wyłącznie na płaskiej, równej, twardej i gładkiej powierzchni, która może bezpiecznie utrzymać w pełni załadowaną ściankę

działową Fabric Room Divide.

35. Stosować wyłącznie zgodnie z przeznaczeniem.
36. Przed każdym użyciem należy przeprowadzić kontrolę. Nie należy używać produktu, jeśli jakieś części są luźne lub uszkodzone.

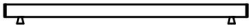
ZAPISZ TĘ INSTRUKCJĘ

PARTS LIST

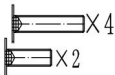
| | | |
|----|---|------------------------|
| A |  | 2 |
| B |  | 2 |
| C |  | 2 |
| D |  | 2 |
| mi |  | 2 |
| F |  | 1 |
| G |  | 1 |
| H |  | 1 |
| I |  | Wstępnie załadowane |

UWAGA : Akcesoria F to zapasowe śrubki do kupienia w prezencie; H to materiał ekranu, należy uważać, aby się nie zabrudził podczas instalacji.

ASSEMBLY STEP

KROK 1

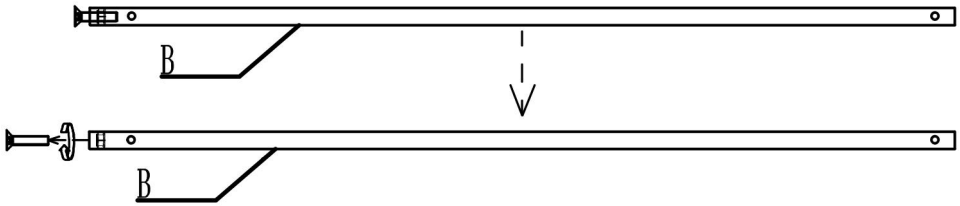

Unscrew from material B and set aside.

X2

KROK 2

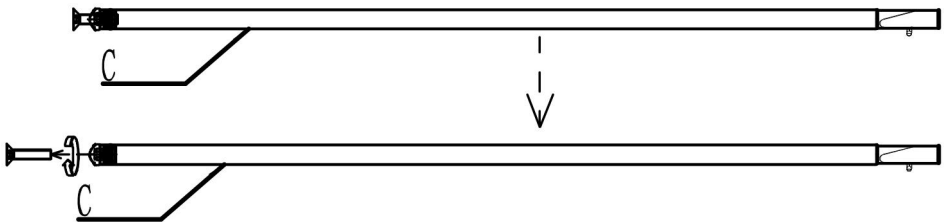

Unscrew from material C and set aside.

X2

KROK 3

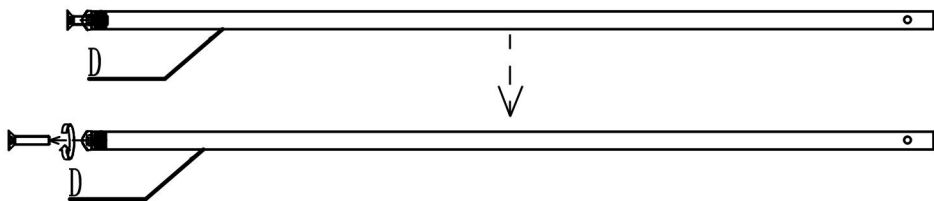

Unscrew from material D and set aside.

X2

KROK 4

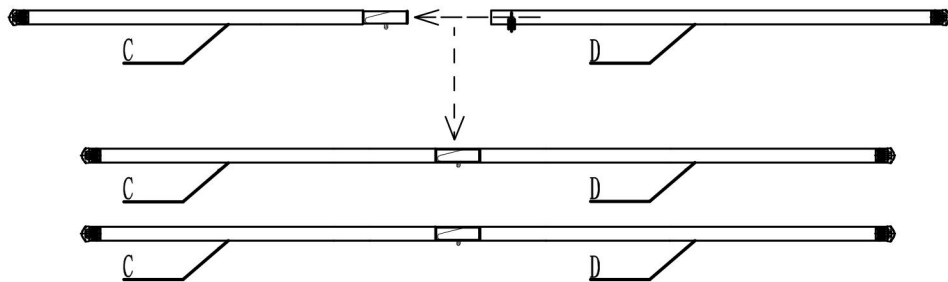

Connect material C with material D, 2 in total.

KROK 5

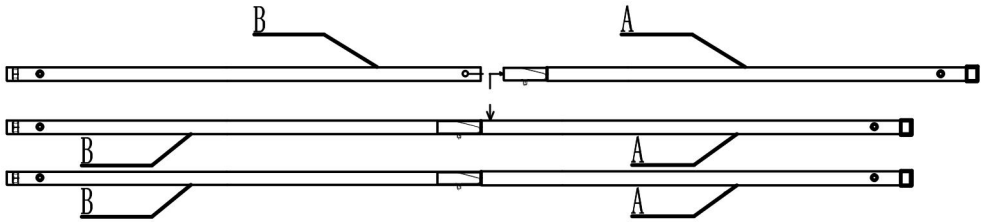

Connect material B with material A, 2 in total.

KROK 6

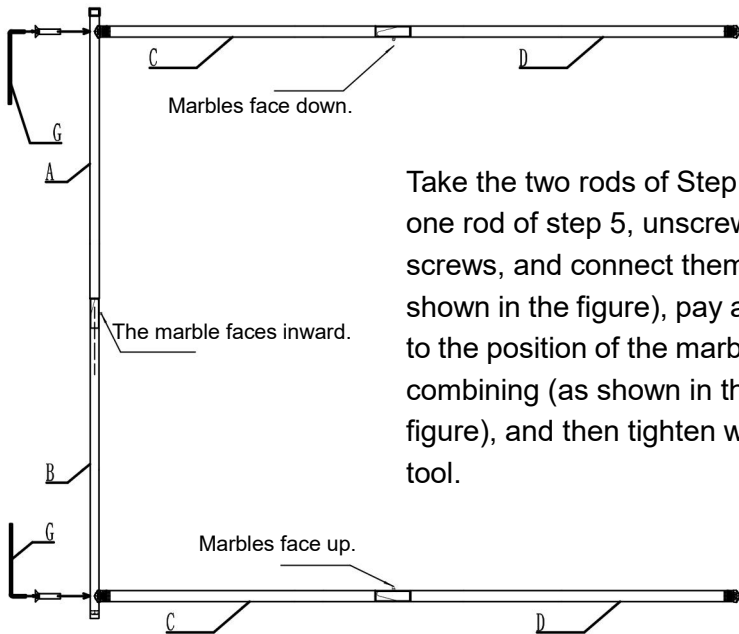

Take the two rods of Step 4 and one rod of step 5, unscrew the screws, and connect them (as shown in the figure), pay attention to the position of the marble when combining (as shown in the figure), and then tighten with G tool.

KROK 7

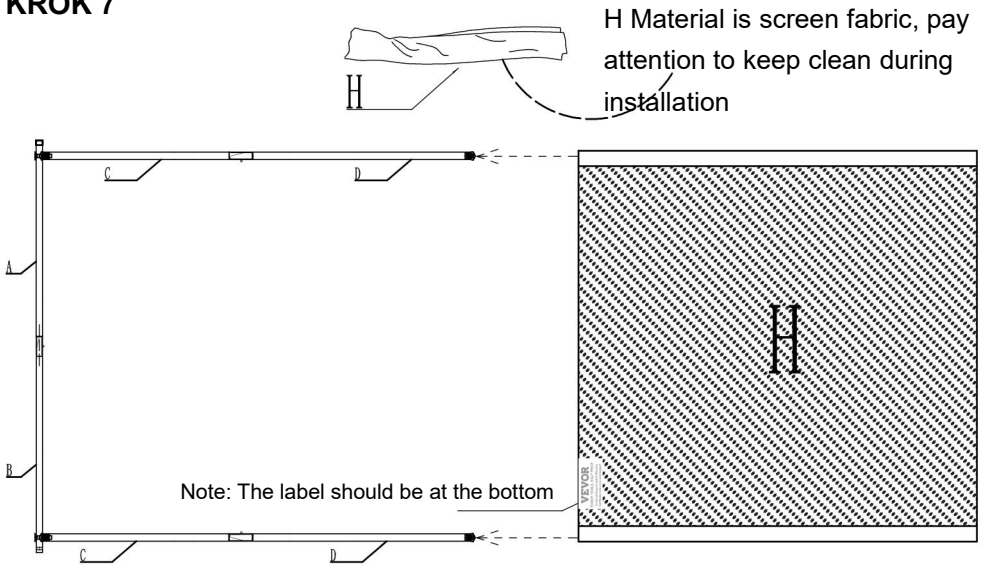

Insert the sleeve of material H into the upper and lower cross bars.

KROK 8

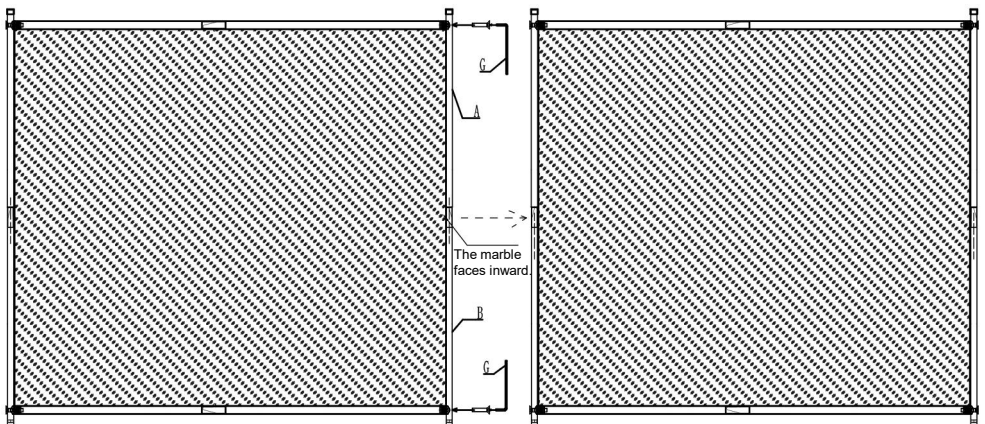

Take the other combined pipe in Step 5 and assemble it in the frame of Step 7, pay attention to the screw that is unscrewed first, and then connect and tighten it (as shown in the figure), pay attention to the position of the marble when assembling it (as shown in the figure), and then tighten it with the G tool.

KROK 9

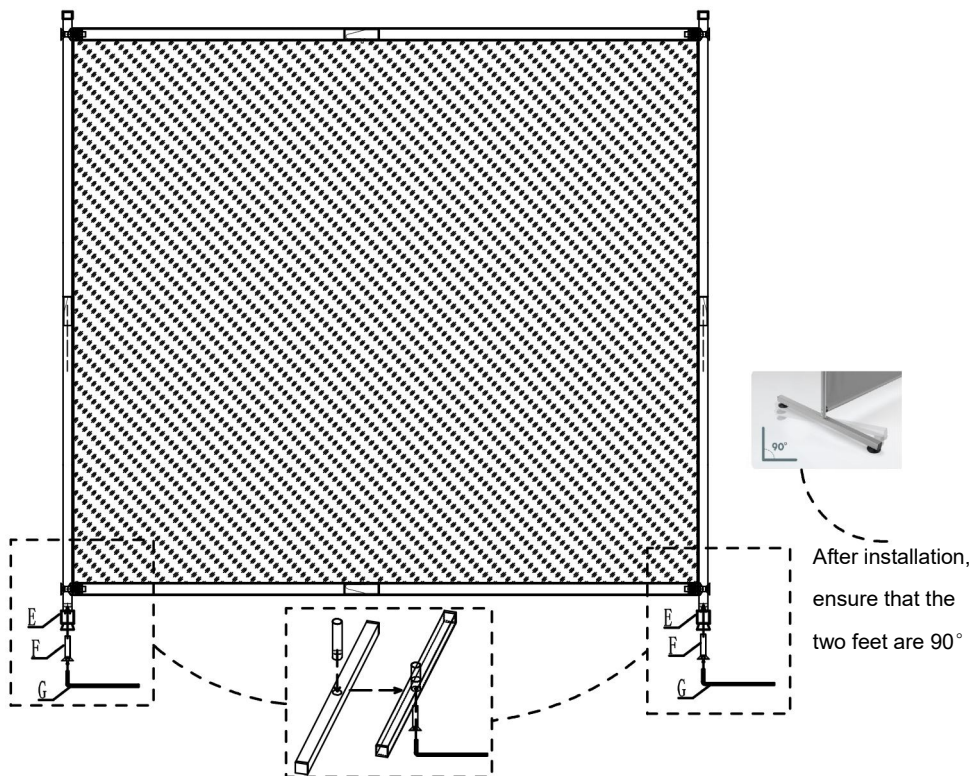

Assemble 2 pieces of material E into the frame in step 8;

Note: In order to make the whole shelf more stable, when installing the foot, first insert the pipe into the foot, then through the unscrewed screw, and then connect, and tighten with the G tool

KROK 10

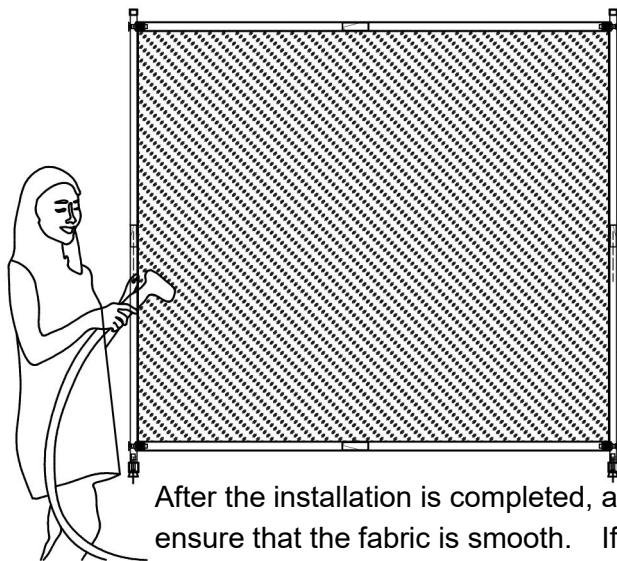

After the installation is completed, arrange the fabric to ensure that the fabric is smooth. If the fabric has wrinkles, you can use a household hanging press to iron it.

KROK 11

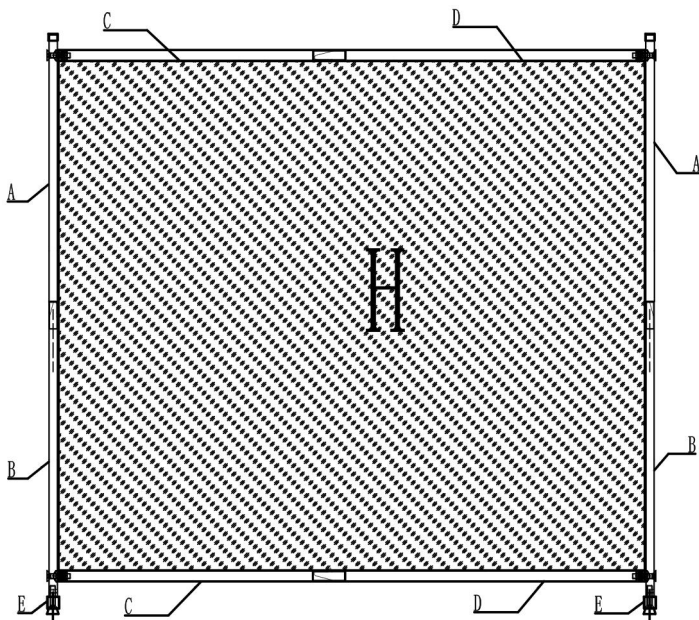

PRODUCT PARAMETER

| Model | PFDMFGHS01 | PFDMFGSH02 | PFDMFGMS03 |
|------------------|------------------|------------|-----------------------|
| Kolor | Czarny | Szary | Kremowy - Kolorowy |
| Liczba paneli | 1 | | |
| Rozmiar produktu | 1810*1815*500 mm | | |

Producent: Shanghaimuxinmuyeyouxiangongsi

Adres: Shuangchenglu 803nong11hao1602A-1609shi, baoshanqu,
Szanghaj 200000 CN.

Importowane do AUS: SIHAO PTY LTD. 1 ROKEVA
STREETEASTWOOD

NSW 2122 Australia

Importowane do USA: Sanven Technology Ltd. Suite 250, 9166 Anaheim
Miejsce, Rancho Cucamonga, CA 91730

| | |
|-----------|------------|
| UK | REP |
|-----------|------------|

YH CONSULTING LIMITED. C/O YH Consulting
Limited Office 147, Centurion House, London
Road, Staines-upon-Thames, Surrey, TW18 4AX

| | |
|-----------|------------|
| EC | REP |
|-----------|------------|

E-CrossStu GmbH
Mainzer Landstr.69,
60329 Frankfurt am Main.

VEVOR[®]

TOUGH TOOLS, HALF PRICE

Techniczny Wsparcie i certyfikat e-gwarancji

www.vevor.com/support

VEVOR[®]

TOUGH TOOLS, HALF PRICE

Technisch Ondersteuning en E-garantiecertificaat

www.vevor.com/support

STOFFEN KAMERVERDELING

Gebruikershandleiding

PFDMFGHS01

PFDMFGSH02

PFDMFGMS03

Wij streven er voortdurend naar om u gereedschappen tegen concurrerende prijzen te leveren.

"Bespaar de helft", "halve prijs" of andere soortgelijke uitdrukkingen die alleen door ons worden gebruikt

geeft een schatting van de besparingen die u kunt behalen door bepaalde gereedschappen te kopen

bij ons vergeleken met de grote topmerken en betekent niet per se dat omslag alle categorieën van tools die wij aanbieden. U wordt vriendelijk verzocht om te verifiëren voorzichtig

wanneer u een bestelling bij ons plaatst, als u daadwerkelijk Besparing
Half in vergelijking met de grote topmerken.

VEVOR®

TOUGH TOOLS, HALF PRICE

FABRIC ROOM DIVIDE

PFDMFGHS01

PFDMFGSH02

PFDMFGMS03

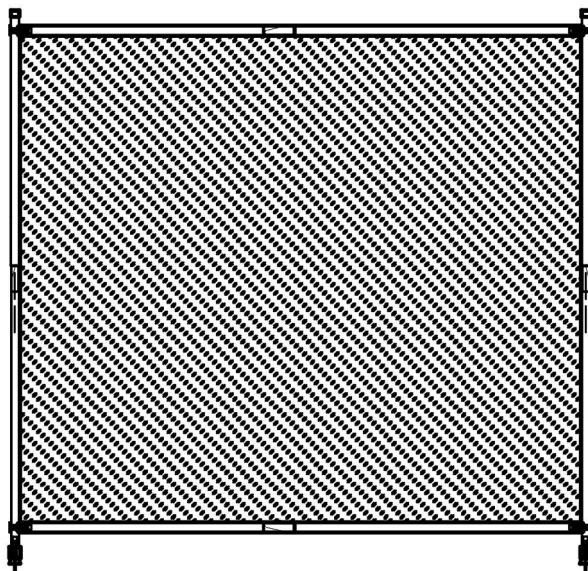

HULP NODIG? NEEM CONTACT MET ONS OP!

Heeft u vragen over het product? Heeft u technische ondersteuning nodig? Neem dan gerust contact met ons op:

Technische ondersteuning en e-garantiecertificaat
www.vevor.com/support

Dit is de originele instructie, lees alle handleidingen zorgvuldig door voordat u het product gebruikt. VEVOR behoudt zich een duidelijke interpretatie van onze gebruikershandleiding voor. Het uiterlijk van het product is afhankelijk van het product dat u hebt ontvangen. Vergeef ons dat we u niet opnieuw zullen informeren als er technologie- of software-updates voor ons product zijn .

SAFETY INSTRUCTIONS

WAARSCHUWING:

Lees dit materiaal voordat u dit product gebruikt. Als u dit niet doet, kan dit leiden tot ernstig letsel.

Voorzorgsmaatregelen bij de montage

49. Monteer alleen volgens deze instructies. Onjuiste montage kan gevaren opleveren.
50. Draag tijdens de montage een ANSI-goedgekeurde veiligheidsbril en stevige werkhandschoenen.
51. Zorg ervoor dat de verzamelplaats schoon en goed verlicht is.
52. Houd omstanders uit de buurt tijdens de montage.
53. Kom niet bijeen als u moe bent of onder invloed van alcohol, drugs of medicijnen.
54. De producteigenschappen gelden uitsluitend voor correct en volledig gemonteerde producten.
55. Monteer de Fabric Room Divide op een vlak, egaal, hard en glad oppervlak dat de Fabric Room Divide veilig kan dragen.
56. Voor aanvullende informatie over de onderdelen die op de volgende pagina's worden vermeld, raadpleegt u het montageschema van deze handleiding. Pak alle onderdelen uit en scheid ze in een schone werkruimte.









Neem voorzorgsmaatregelen

37. NIET OP DIT ARTIKEL ZITTEN OF STAAN.
38. Dit product is geen speelgoed. Laat kinderen niet met of in de buurt van dit item spelen.
39. Overschrijd de aangegeven waarden niet draagvermogen.
40. Gebruik het apparaat alleen op een vlak, egaal, hard en glad oppervlak dat een volledig gevulde Fabric Room Divide veilig kan dragen.
41. Alleen gebruiken zoals bedoeld.
42. Controleer het product voor elk gebruik. Gebruik het niet als er

onderdelen loszitten of beschadigd zijn.

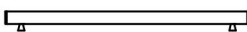
BEWAAR DEZE HANDLEIDING

PARTS LIST

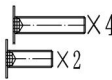
| | | |
|----|---|------------------------------|
| A |  | 2 |
| B |  | 2 |
| C |  | 2 |
| D |  | 2 |
| Ik |  | 2 |
| F |  | 1 |
| G |  | 1 |
| H |  | 1 |
| I |  | Vooraf opnieuw geladen |

LET OP : De accessoires F zijn reserveschroeven voor cadeaus; H is de stof van het scherm. Let op dat deze niet vies wordt tijdens de installatie.

ASSEMBLY STEP

STAP 1

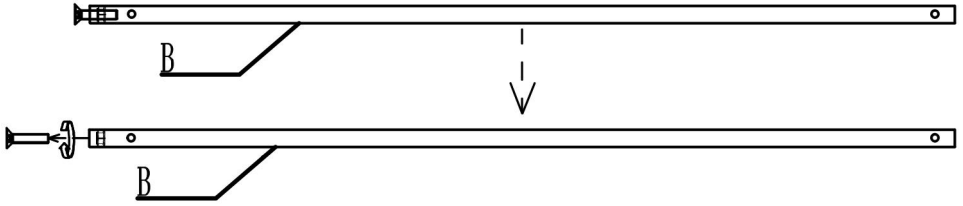

Unscrew from material B and set aside.

X2

STAP 2

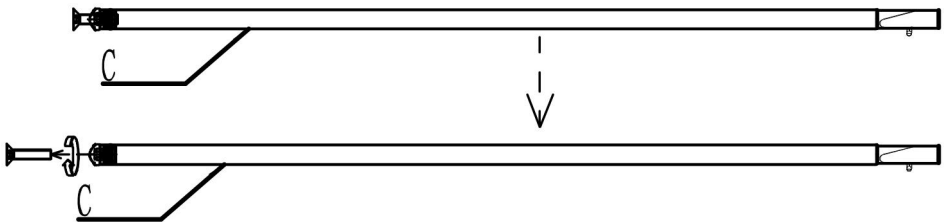

Unscrew from material C and set aside.

X2

STAP 3

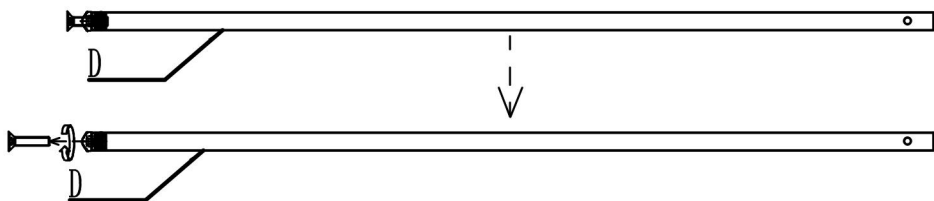

Unscrew from material D and set aside.

X2

STAP 4

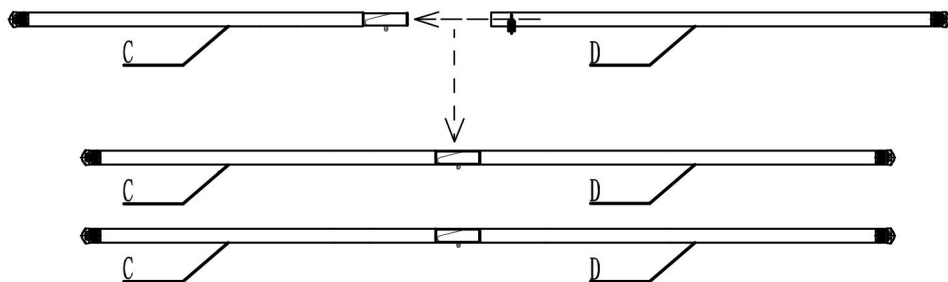

Connect material C with material D, 2 in total.

STAP 5

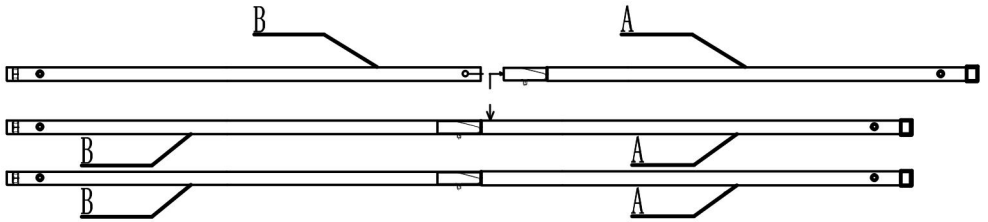

Connect material B with material A, 2 in total.

STAP 6

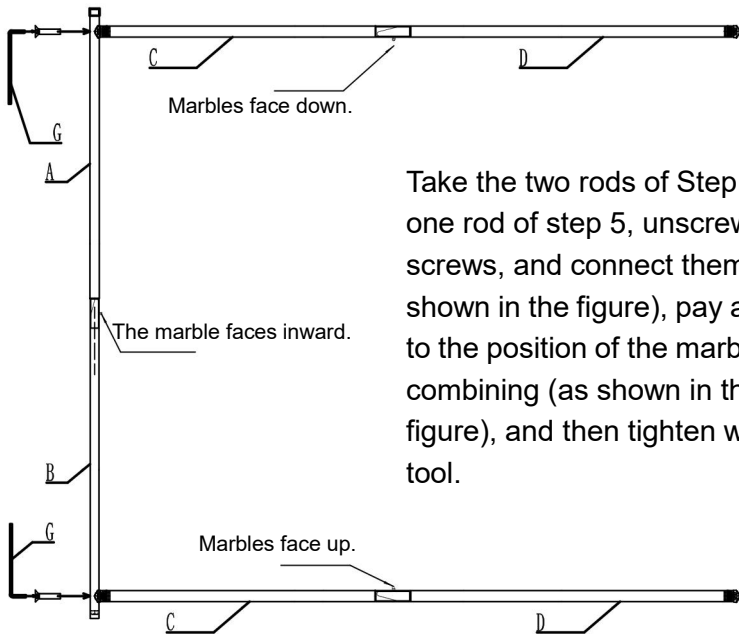

Take the two rods of Step 4 and one rod of step 5, unscrew the screws, and connect them (as shown in the figure), pay attention to the position of the marble when combining (as shown in the figure), and then tighten with G tool.

STAP 7

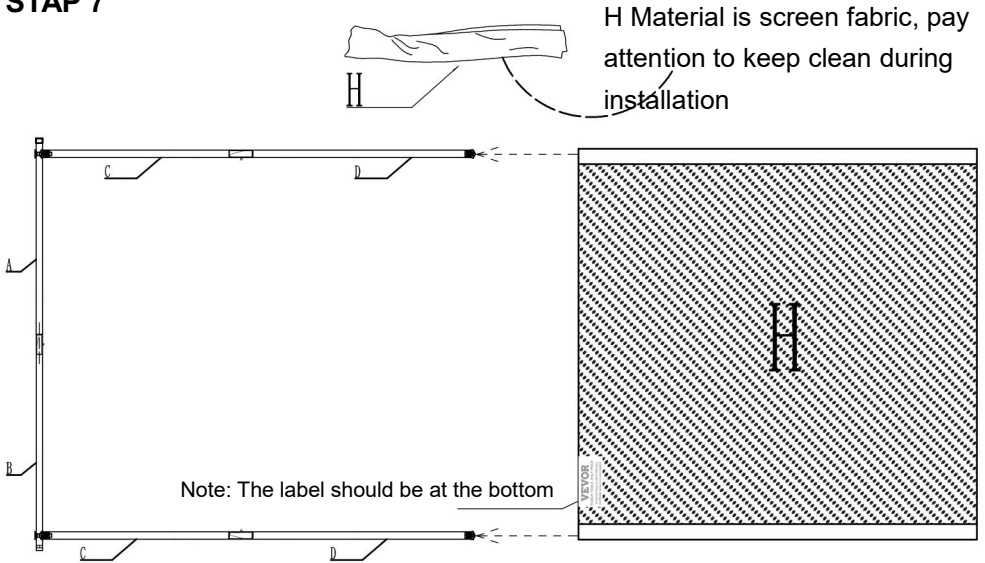

Insert the sleeve of material H into the upper and lower cross bars.

STAP 8

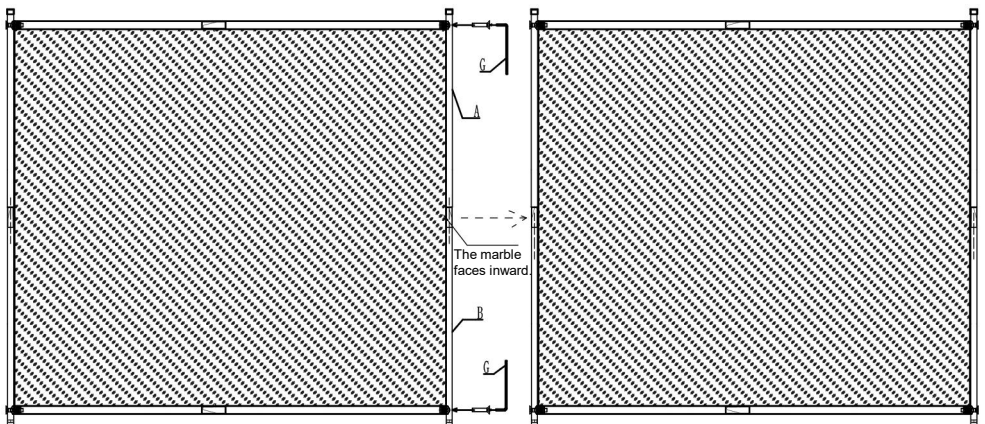

Take the other combined pipe in Step 5 and assemble it in the frame of Step 7, pay attention to the screw that is unscrewed first, and then connect and tighten it (as shown in the figure), pay attention to the position of the marble when assembling it (as shown in the figure), and then tighten it with the G tool.

STAP 9

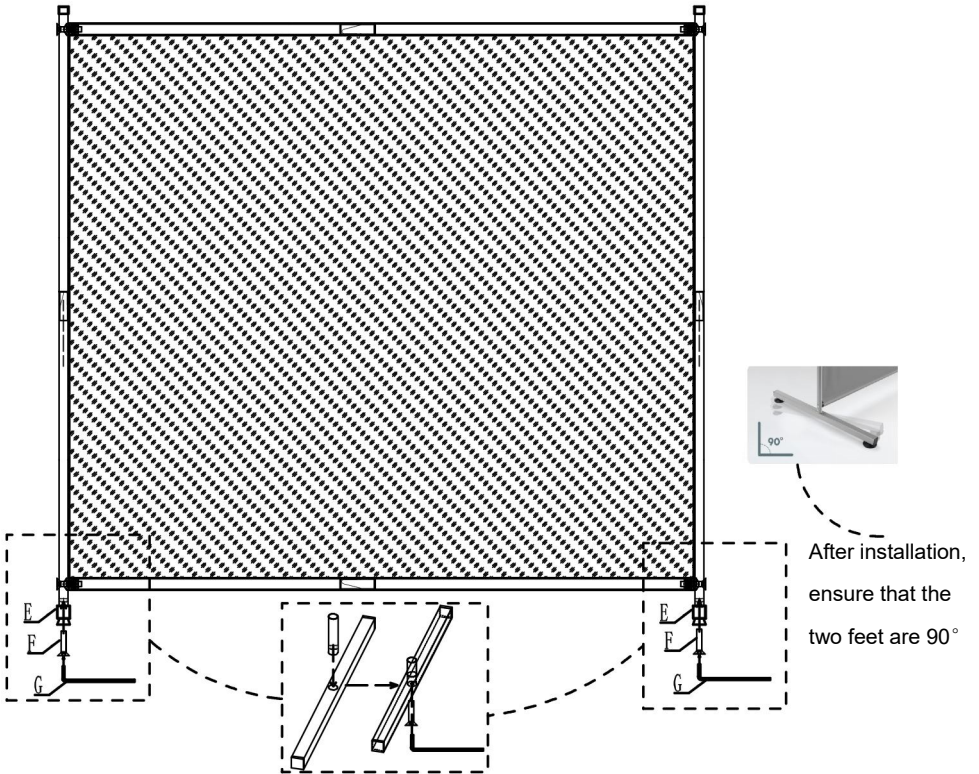

Assemble 2 pieces of material E into the frame in step 8;

Note: In order to make the whole shelf more stable, when installing the foot, first insert the pipe into the foot, then through the unscrewed screw, and then connect, and tighten with the G tool

STAP 10

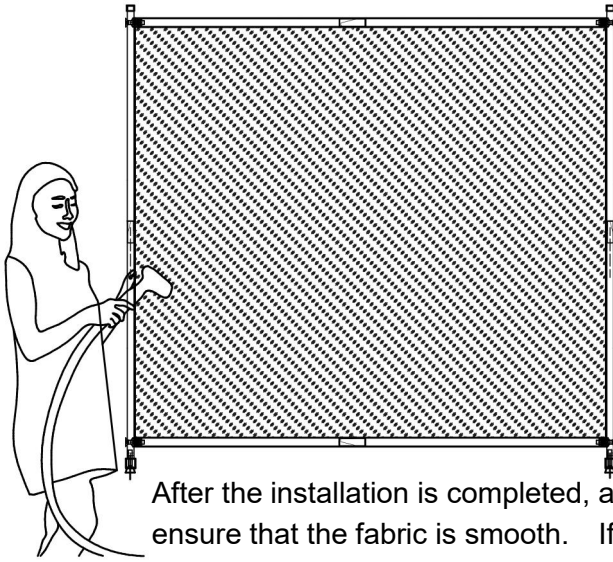

After the installation is completed, arrange the fabric to ensure that the fabric is smooth. If the fabric has wrinkles, you can use a household hanging press to iron it.

STAP 11

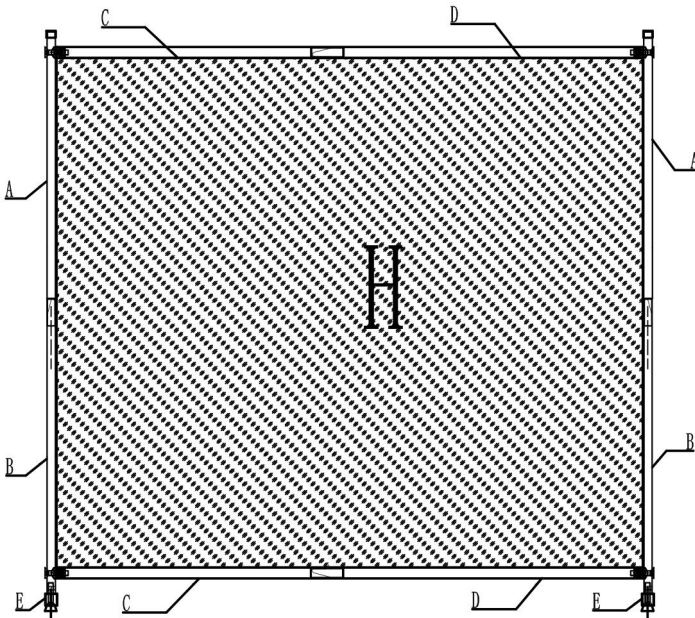

PRODUCT PARAMETER

| Model | PFDMSGHS01 | PFDMSGSH02 | PFDMSGMS03 |
|----------------|-----------------|------------|--------------|
| Kleur | B gebrek | Grijs | Crèmekleurig |
| Aantal panelen | 1 | | |
| Productgrootte | 1810*1815*500mm | | |

Fabrikant: Shanghai muxinmuyeyouxiangongsi

Adres: Shuangchenglu 803nong11hao1602A-1609shi, baoshanqu, Sjanghai 200000 CN.

Geïmporteerd naar AUS: SIHAO PTY LTD. 1 ROKEVA STREETEASTWOOD

NSW 2122 Australië

Geïmporteerd naar de VS: Sanven Technology Ltd. Suite 250, 9166 Anaheim

Plaats, Rancho Cucamonga, CA 91730

| | |
|-----------|------------|
| UK | REP |
|-----------|------------|

YH CONSULTING LIMITED. C/O YH Consulting
Limited Office 147, Centurion House, London
Road, Staines-upon-Thames, Surrey, TW18 4AX

| | |
|-----------|------------|
| EC | REP |
|-----------|------------|

E-CrossStu GmbH
Mainzer Landstr.69,
60329 Frankfurt am Main.

VEVOR[®]

TOUGH TOOLS, HALF PRICE

Technisch Ondersteuning en E-garantiecertificaat

www.vevor.com/support

VEVOR[®]

TOUGH TOOLS, HALF PRICE

Teknisk Support och e-garanticertifikat

www.vevor.com/support

TYG RUMSDELNING

Användarmanual

PFDMFGHS01

PFDMFGSH02

PFDMFGMS03

Vi fortsätter att vara engagerade i att ge dig verktyg till konkurrenskraftiga priser. "Spara hälften", "Halva priset" eller andra liknande uttryck som endast används av oss representerar en uppskattning av besparingar du kan dra nytta av att köpa vissa verktyg med oss jämfört med de stora toppmärkena och betyder inte nödvändigtvis att täcka alla kategorier av verktyg som erbjuds av oss. Du påminns vänligen om att verifiera försiktigt

när du gör en beställning hos oss om du faktiskt gör det Sparande Halv i jämförelse med de främsta varumärkena.

VEVOR®

TOUGH TOOLS, HALF PRICE

FABRIC ROOM DIVIDE

PFDMFGHS01

PFDMFGSH02

PFDMFGMS03

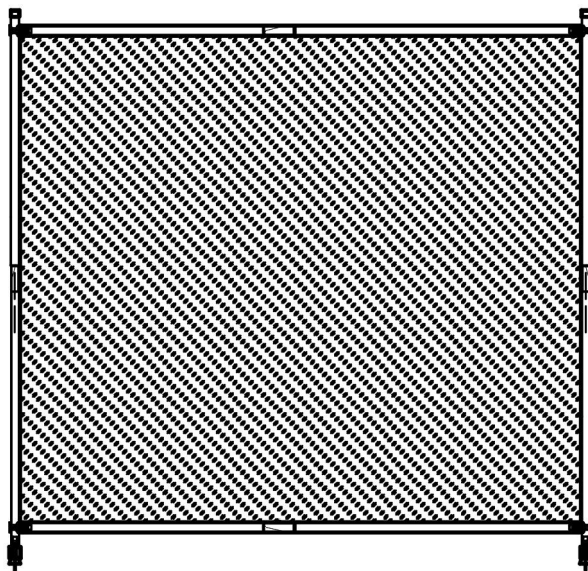

BEHÖVER HJÄLP? KONTAKTA OSS!

Har du produktfrågor? Behöver du teknisk support? Kontakta oss gärna:

Teknisk support och e-garanticertifikat
www.vevor.com/support

Detta är den ursprungliga instruktionen, läs alla instruktioner noggrant innan du använder den. VEVOR reserverar sig för en tydlig tolkning av vår användarmanual. Utseendet på produkten är beroende av den produkt du fått. Ursäkta oss att vi inte kommer att informera dig igen om det finns någon teknik eller mjukvaruuppdateringar på vår produkt.

SAFETY INSTRUCTIONS

WARNING:

Läs detta material innan du använder denna produkt. Underlåtenhet att göra det kan resultera i allvarliga skador.

Försiktighetsåtgärder vid montering









57. Montera endast enligt dessa instruktioner. Felaktig montering kan skapa faror.
58. Använd ANSI-godkända skyddsglasögon och kraftiga arbetshandskar vid montering.
59. Håll monteringsområdet rent och väl upplyst.
60. Håll åskådare borta från området under monteringen.
61. Sätt dig inte ihop om du är trött eller påverkad av alkohol, droger eller medicin.
62. Produktens egenskaper gäller endast för korrekt och färdigmonterade produkter.
63. Montera på en plan, jämn, hård och slät yta som säkert kan stödja tygrumsdelningen.
64. För ytterligare information om delarna som listas på följande sidor, se monteringsdiagrammet i denna manual. Packa upp och separera alla delar på ett rent arbetsområde.

Använd försiktighetsåtgärder

43. SIT ELLER STÅ INTE PÅ DETTA FÖREMÅL.
44. Denna produkt är inte en leksak. Låt inte barn leka med eller nära detta föremål.
45. Överskrid inte specificerat viktkapacitet.
46. Använd endast på en plan, jämn, hård och slät yta som säkert kan bära upp en fulladdad rumsdelning av tyg.
47. Använd endast som avsett.
48. Inspektera före varje användning; Använd inte om delar är lösa eller skadade.

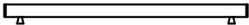
SPARA DENNA MANUAL

PARTS LIST

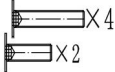
| | | |
|-----|---|-------------|
| A |  | 2 |
| B |  | 2 |
| C |  | 2 |
| D |  | 2 |
| E |  | 2 |
| F |  | 1 |
| G |  | 1 |
| H |  | 1 |
| jag |  | P laddas om |

OBS : F-tillbehör är reservskruvar för present; H är skärmens tyg, var uppmärksam på att inte bli smutsig vid installation.

ASSEMBLY STEP

STEP 1

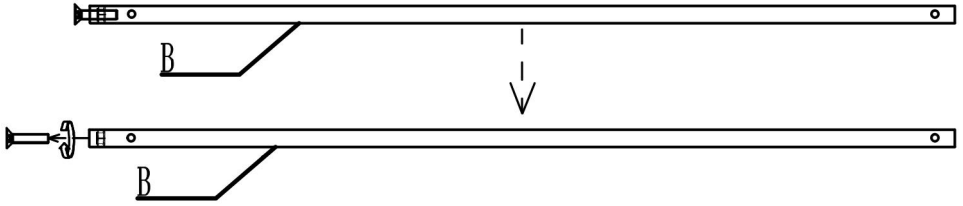

Unscrew from material B and set aside.

X2

STEP 2

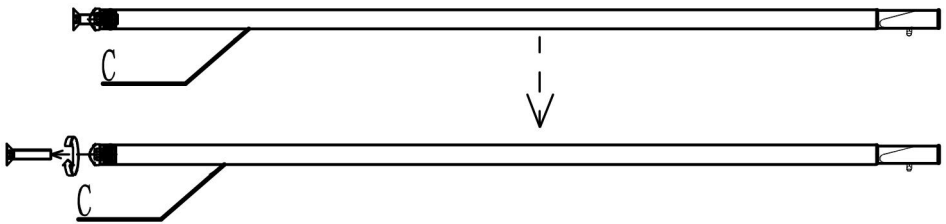

Unscrew from material C and set aside.

X2

STEG 3

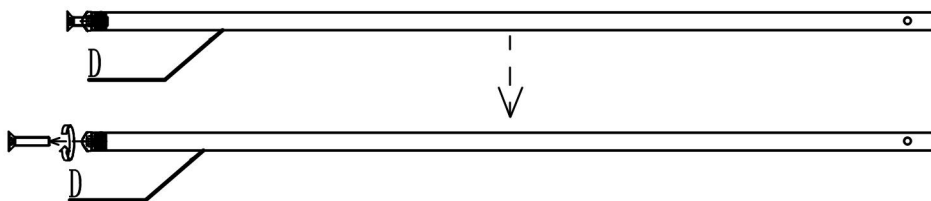

Unscrew from material D and set aside.

X2

STEG 4

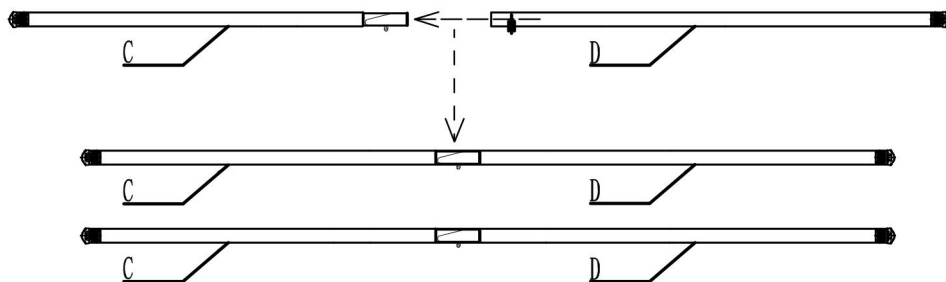

Connect material C with material D, 2 in total.

STEP 5

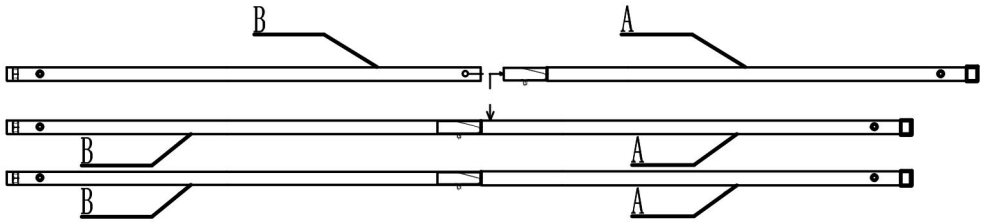

Connect material B with material A, 2 in total.

STEP 6

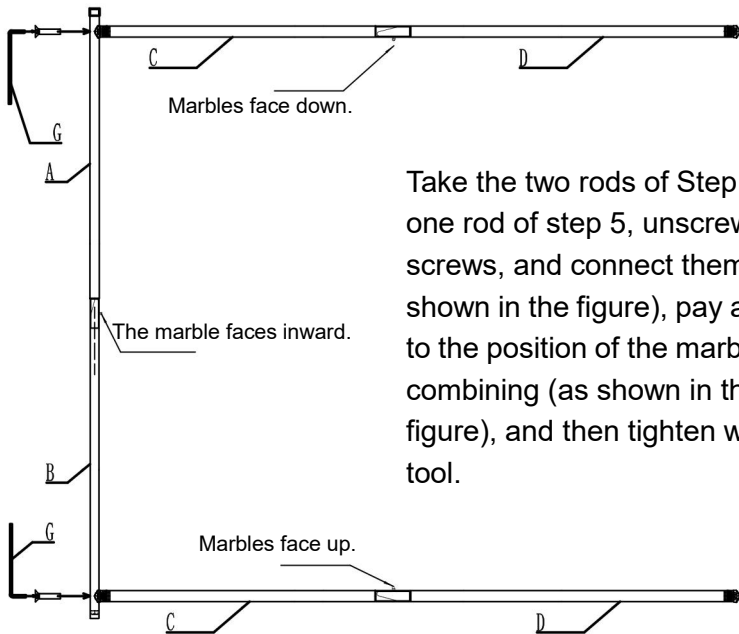

Take the two rods of Step 4 and one rod of step 5, unscrew the screws, and connect them (as shown in the figure), pay attention to the position of the marble when combining (as shown in the figure), and then tighten with G tool.

STEP 7

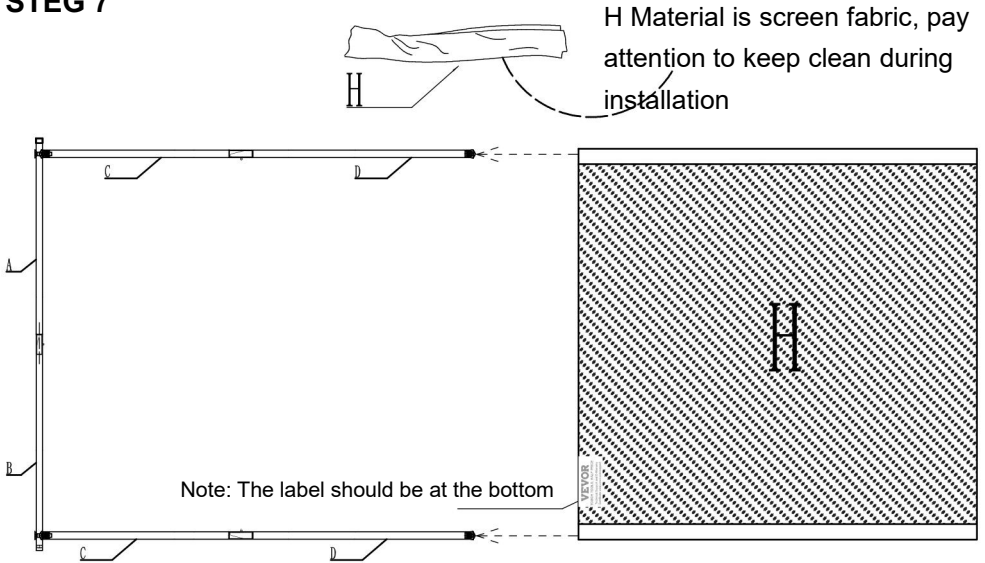

Insert the sleeve of material H into the upper and lower cross bars.

STEP 8

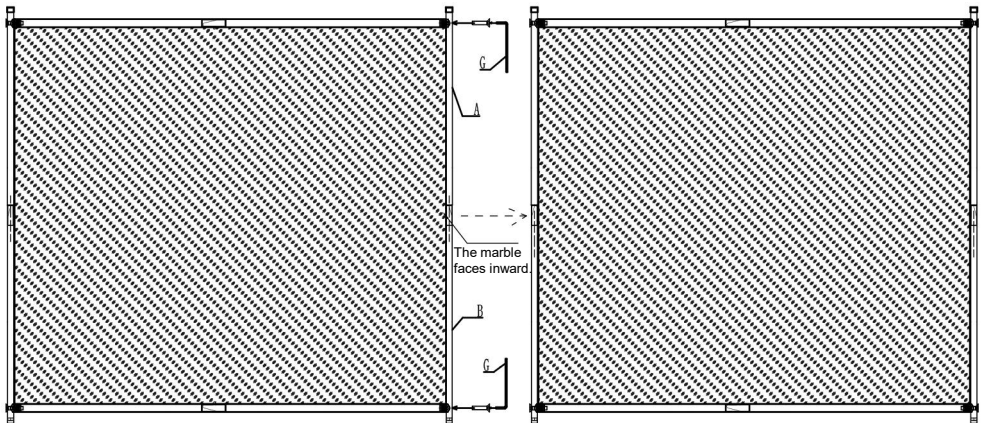

Take the other combined pipe in Step 5 and assemble it in the frame of Step 7, pay attention to the screw that is unscrewed first, and then connect and tighten it (as shown in the figure), pay attention to the position of the marble when assembling it (as shown in the figure), and then tighten it with the G tool.

STEP 9

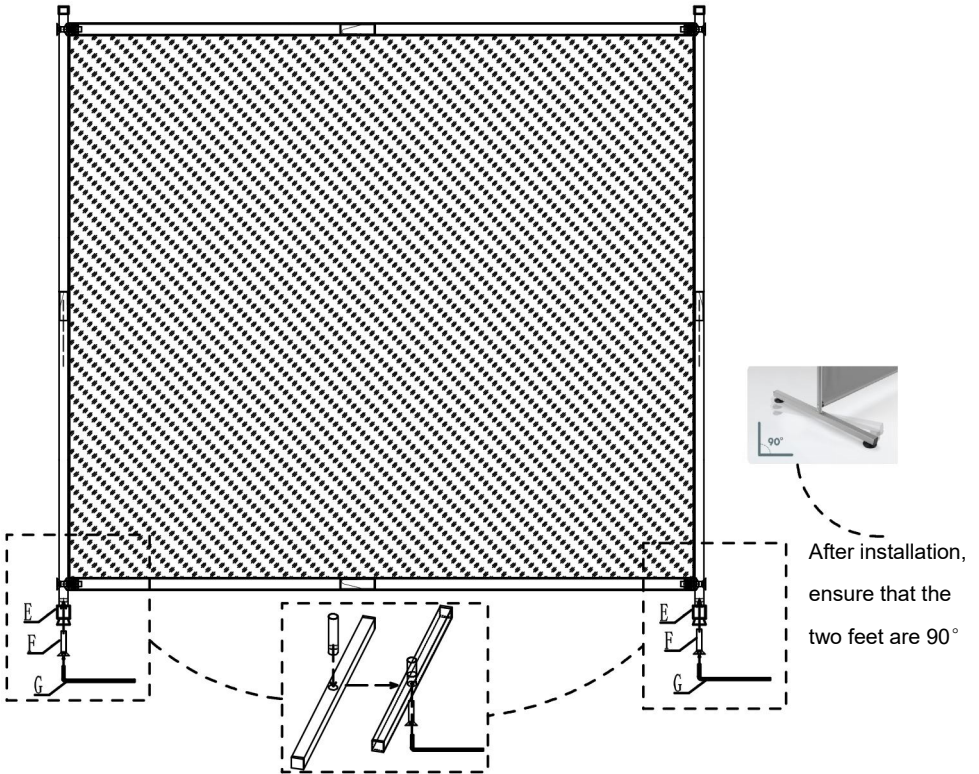

Assemble 2 pieces of material E into the frame in step 8;

Note: In order to make the whole shelf more stable, when installing the foot, first insert the pipe into the foot, then through the unscrewed screw, and then connect, and tighten with the G tool

STEP 10

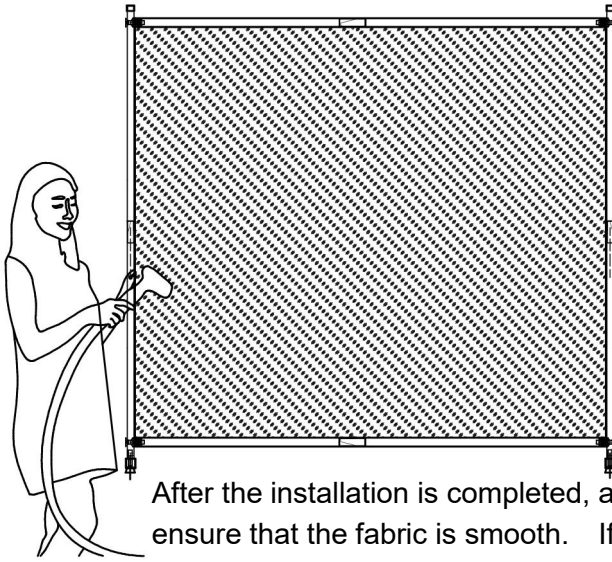

After the installation is completed, arrange the fabric to ensure that the fabric is smooth. If the fabric has wrinkles, you can use a household hanging press to iron it.

STEP 11

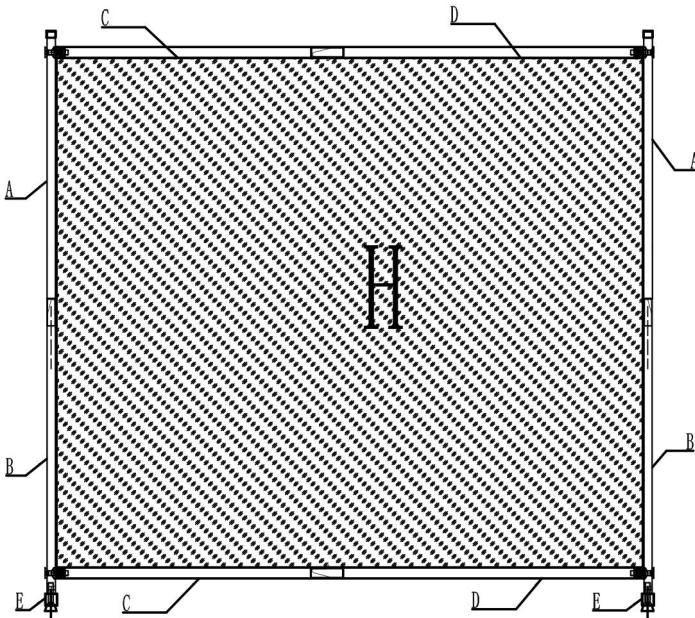

PRODUCT PARAMETER

| Modell | PFDMFGHS01 | PFDMFGSH02 | PFDMFGMS03 |
|----------------|-----------------|------------|----------------|
| Färg | B brist | G ray | C ream- Färgad |
| Antal paneler | 1 | | |
| Produktstorlek | 1810*1815*500mm | | |

Tillverkare: Shanghaimuxinmuyeyouxiangongsi

Adress: Shuangchenglu 803nong11hao1602A-1609shi, baoshanqu, shanghai 200 000 CN.

Importerad till AUS: SIHAO PTY LTD. 1 ROKEVA STREETEASTWOOD NSW 2122 Australien

Importerad till USA: Sanven Technology Ltd. Suite 250, 9166 Anaheim Place, Rancho Cucamonga, CA 91730

| | |
|-----------|------------|
| UK | REP |
|-----------|------------|

YH CONSULTING LIMITED. C/O YH Consulting Limited Office 147, Centurion House, London Road, Staines-upon-Thames, Surrey, TW18 4AX

| | |
|-----------|------------|
| EC | REP |
|-----------|------------|

E-CrossStu GmbH
Mainzer Landstr.69,
60329 Frankfurt am Main.

VEVOR[®]

TOUGH TOOLS, HALF PRICE

Teknisk Support och e-garanticertifikat

www.vevor.com/support

