

PHILIPS

HR2342

User manual / 2

用户手册 / 37



Always here to help you

Register your product and get support at

www.philips.com/welcome



Quick Start Guide/ 快速入门指南

Disassembling and cleaning before first use 首次使用前的拆卸和清洁

	<60°C (140°F)			
	✓	✓	✓	✓
	✓	✓	✓	✓
	✓	✓	✓	✓
	✗	✗	✓	✓
	✓	✓	✓	✓

Assembling 组装

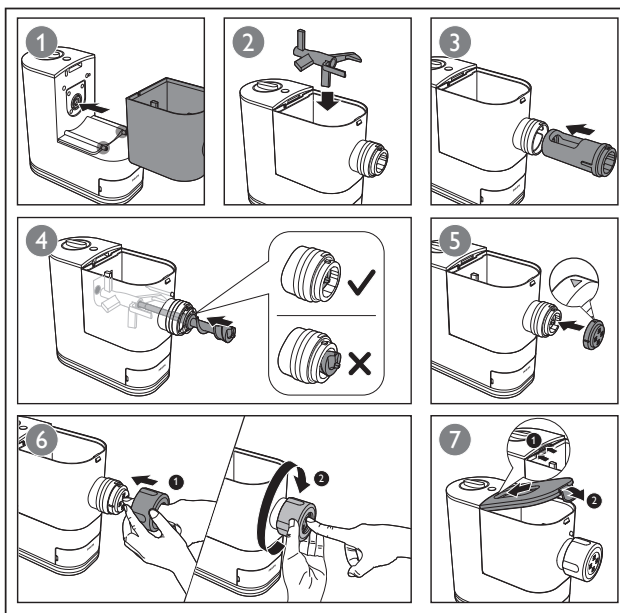

Using the Pasta and noodle maker 使用意面 / 面条机



Table of Contents

Important	6
What's in the box	11
Overview	12
Disassembling and cleaning before first use	14
Assembling	16
Using the Pasta and noodle maker	19
Cleaning	26
Storage	29
Troubleshooting	30
Product information	33
Recycling	33
Warranty	34

Important

Safety

Read this user manual carefully before you use the appliance, and save it for future reference.

Warning

- Before you connect the appliance to the power, make sure that the voltage indicated on the bottom of the appliance corresponds to the local power voltage.
- Make sure that your hands are dry before you insert the plug into the power outlet.
- Do not immerse the main unit in water or rinse it with water or other liquid.
- To prevent a short circuit or an electric shock, do not pour water or any liquid on the appliance.
- Make sure that the plug is firmly inserted into the power outlet.
- Never connect this appliance to a timer switch or separate remote control system.
- Make sure that the appliance is assembled correctly before you insert the plug into the power outlet.
- If the power cord, the plug, or other parts are damaged, do not use the appliance.
- Make sure the control knob is in the OFF position and the appliance is unplugged when not in use, left unattended, before assembling, disassembling, cleaning or storing. Always make sure the appliance is properly assembled before putting the plug into the wall outlet and operating the appliance.

Warning

The appliance will not operate unless it is properly assembled.

- Do not place hands, fingers or utensils in the mixing chamber of the appliance unless the control knob is in the OFF position, the appliance is unplugged and the motor and mixing paddle have come to a complete stop. Ensure the motor and the mixing paddle have completely stopped before disassembling, cleaning or storing.
- If the power cord is damaged, you must have it replaced by Philips, a service center authorized by Philips or similarly qualified persons to avoid a hazard.
- Do not replace parts of the appliance by yourself.
- This appliance shall not be used by children. Keep the appliance and its power cord out of reach of children.
- This appliance is not intended for use by persons with reduced physical, sensory or mental capabilities, or lack of experience and knowledge, unless they have been given supervision or instruction concerning use of the appliance by a person responsible for their safety.
- Children should be supervised to ensure that they do not play with the appliance.
- To prevent any accidents, do not use the appliance if it is damaged for any reason.

Caution

- Before using the appliance for the first time, disassemble and wash the accessories thoroughly (refer to the chapter “Disassemble and cleaning before first use”).
- This appliance is intended for household use only.
- Never use any accessories or parts from other manufacturers or that Philips does not specifically recommend. If you use such accessories or parts, your guarantee becomes invalid.
- Do not use this appliance on an unstable or uneven surface.
- Do not disconnect the power cord before the processing is complete. If you have to stop processing, disconnect the power cord before you perform other operations.
- Do not exceed the maximum operation cycle of 2 cycles continuously at all applications. To better protect the lifetime of the appliance, you can restart using the appliance after 30 minutes upon 2 continuous operation cycles.
- If you intend to use the appliance continuously, clean the shaping disc with the supplied cleaning tool each time after use.
- Do not bend, jerk, twist, or bundle the power cord forcibly, nor put it under heavy objects.
- Unplug the appliance when not in use.
- Do not use the appliance near flammable objects such as table cloth or drapes.

Caution

- Pull out the power plug immediately after you detect smoke.
- When unplugging the power cord, do not pull the cable but grab the plug part.
- Keep the power plug clean.
- Do not put heavy objects on the appliance.
- This appliance is designed as consumer kitchen appliance. Do not use for any other purpose.
- Do not move the appliance while it is operating.
- Disconnect the power cord if the appliance is left unattended and before assembling, disassembling or cleaning.
- Place the appliance in a dry and well ventilated place after use.
- Do not hold and move the appliance by grabbing the shaping disc holder. Hold the main unit to do so.
- Make sure the shaping disc hole is unblocked each time before using.
- Keep hands, hair, clothing, as well as spatulas and other utensils away from appliance during operation to reduce the risk of injury to persons, and/or damage to the appliance.
- Do not put your fingers or other objects into the Pasta and noodle maker opening while it is in operation. Avoid contact with moving parts.
- Do not attempt to defeat the cover interlock mechanism.

Caution

- The shaping discs and all detachable parts of the appliance are dishwasher safe. When you clean them in dishwasher, make sure to select the proper program which has a maximum temperature at no higher than 60°C (140°F).
- Use only on properly grounded outlet.

Electromagnetic fields (EMF)

This Philips appliance complies with all applicable standards and regulations regarding exposure to electromagnetic fields.

Congratulations on your purchase, and welcome to Philips!
To fully benefit from the support that Philips offers, register your product at www.philips.com/welcome.
Read this user manual carefully before you install and use the appliance. Save it for future reference.

What's in the box

Main unit

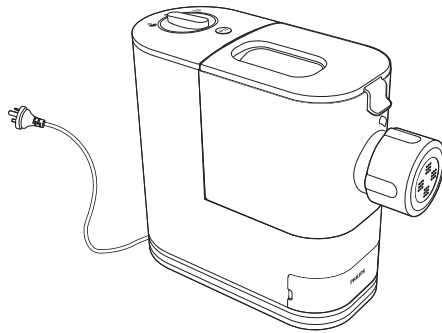

User manual



Recipe book



Flat cleaning tool



Flour cup



Water cup



Shaping discs:

Spaghetti/
Thin noodle*



Fettuccine/
Ban Mian noodle



Penne



* The spaghetti/thin noodle shaping disc is assembled on the appliance upon purchase.

Overview

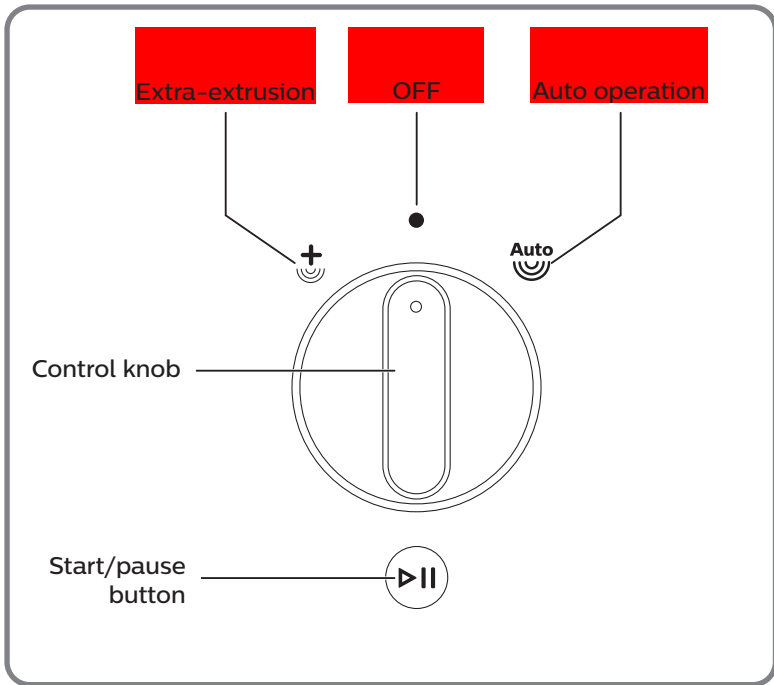
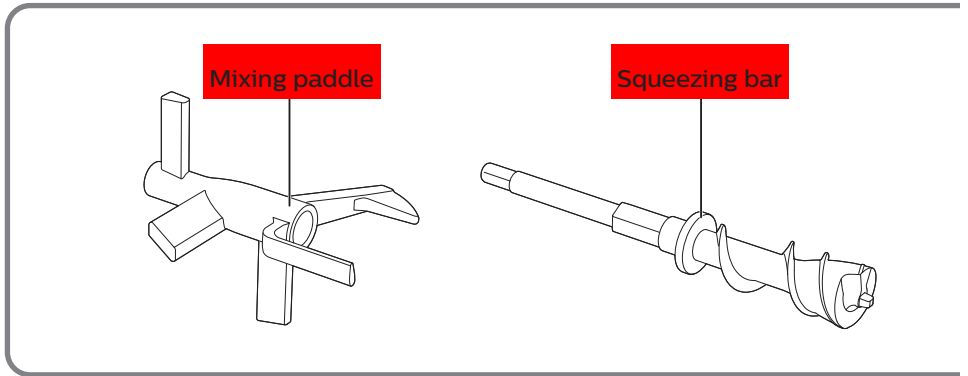

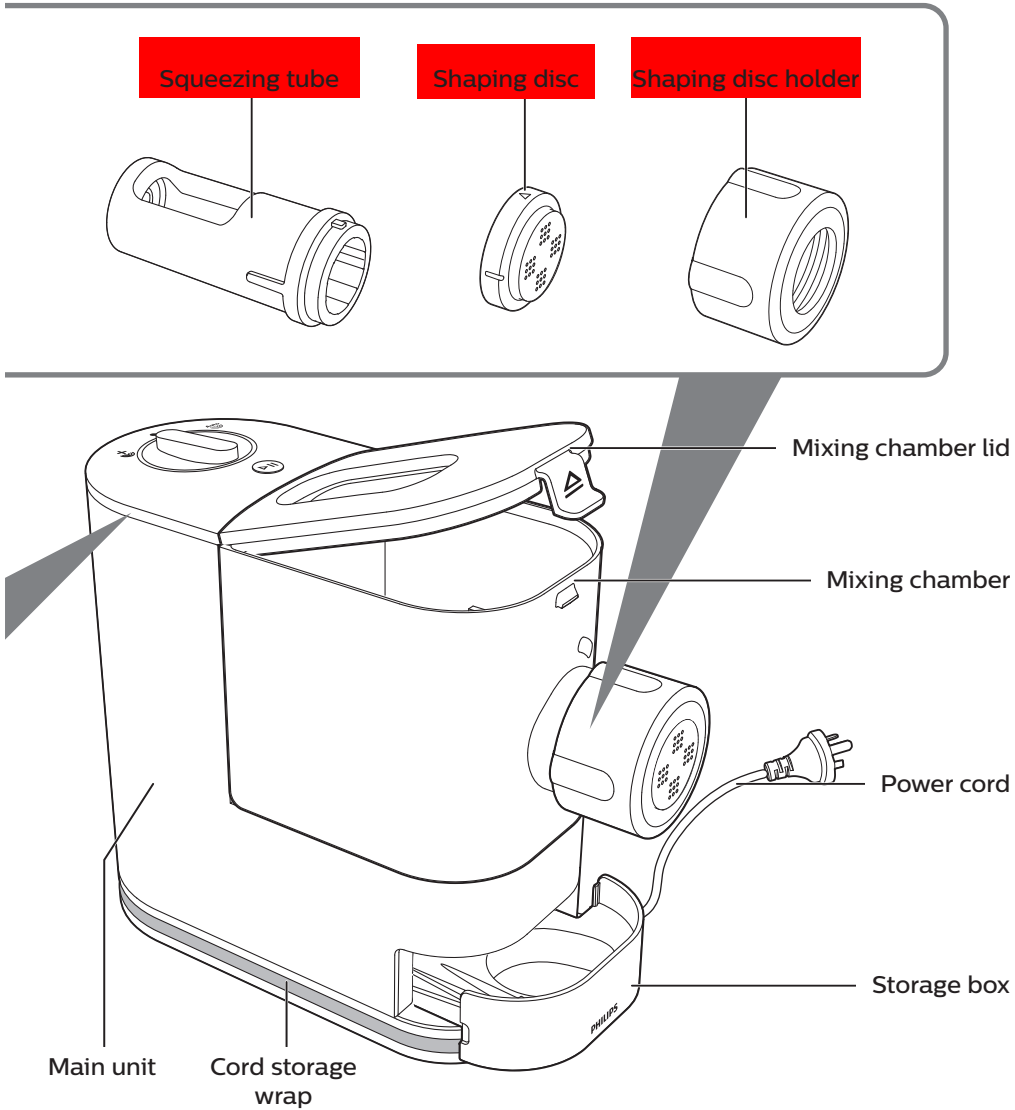

Disassembling and cleaning before first use

Important

- Before using the appliance for the first time, remove and safely discard any packing material and /or promotional labels.
- Take out all detachable parts and accessories, wash and thoroughly dry all parts and accessories (refer to the chapter "Cleaning").
- Do not use water to rinse or soak the main unit, the power cord, or the power plug.
- Do not use a scouring pad or similar cleaners as these will scratch the plastic surface and affect the lifetime of the Pasta and noodle maker.
- The shaping discs and all detachable parts of the appliance are dishwasher safe. When you clean them in a dishwasher, make sure to select the proper program which has a maximum temperature at no higher than 60°C (140°F).
- This appliance is intended for household use only.

- 1 **1** Pull the lid to unlock it and then **2** remove the lid from the mixing chamber.

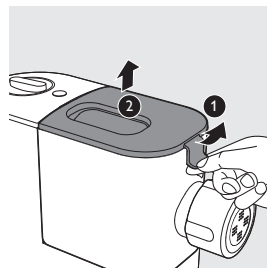

- 2 Slide the mixing chamber off the main unit.

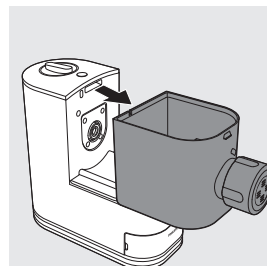

- 3 Turn the shaping disc holder counterclockwise to remove it from the mixing chamber outlet.

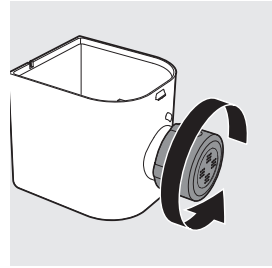

- 4 ① Put your finger in the mixing chamber and push the squeezing tube outwards to slide it out of the mixing chamber outlet. ② Detach the shaping disc, ③ and then pull the squeezing bar out of the squeezing tube.

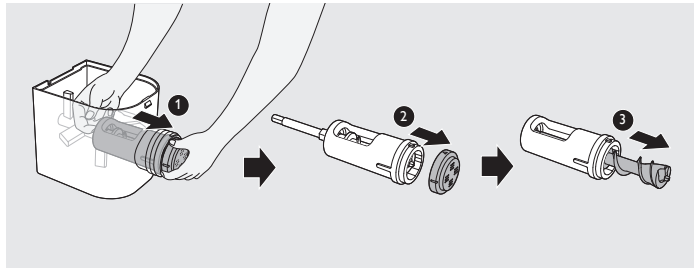

- 5 Take the mixing paddle out of the mixing chamber.

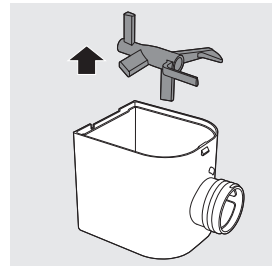

- 6 Clean all detachable parts and accessories, and then wipe them dry.

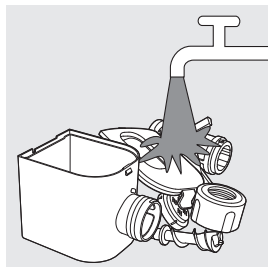

Assembling

Follow below assembling steps to install the Pasta and noodle maker.

Important

- Make sure the appliance is not plugged in during assembly.

- 1 Slide the mixing chamber onto the main unit.

Note:

- Make sure the fixing levers **1** on the main unit are fitted with the openings on the bottom of the mixing chamber.

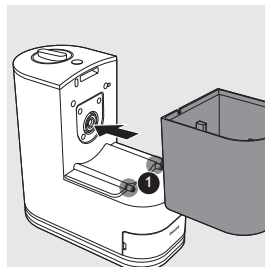

- 2 Put the mixing paddle in the mixing chamber as shown in the illustration.

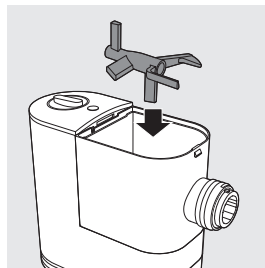

- 3 Insert the squeezing tube into the mixing chamber.

Note:

- Make sure the big opening on the squeezing tube faces up when you insert the tube into the chamber.

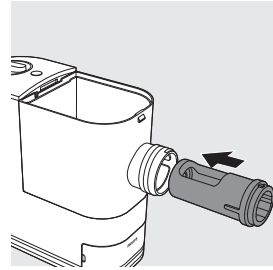

- 4 Insert the squeezing bar into the mixing chamber. Make sure the squeezing bar slides all the way through both the squeezing tube and the mixing paddle and into the shaft in the main unit.

Note:

- Slightly turn the mixing paddle to make sure the squeezing bar is connected correctly with the shaft ❶ in the main unit.

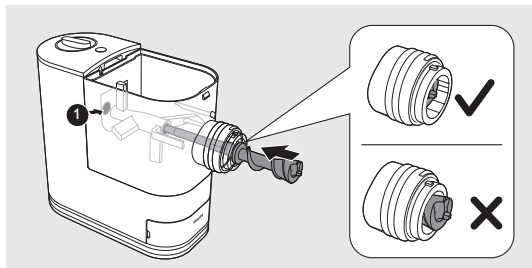

- 5 Attach the shaping disc on the mixing chamber outlet.

Note:

- Make sure the flat side of the shaping disc is facing out.
- Make sure the shaping disc fits into the fixing point on the squeezing bar.
- Make sure the arrow on the shaping disc face upwards when you attach it on the mixing chamber outlet.

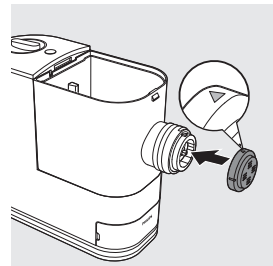

- 6 **1** Press the shaping disc through the opening of the shaping disc holder, and then assemble the holder on the mixing chamber outlet. **2** Turn the holder clockwise to firmly lock it in place.

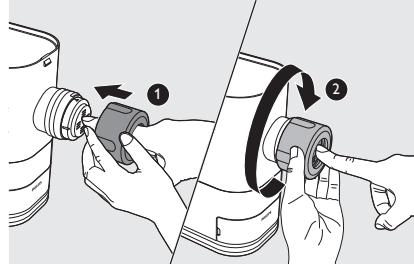

Always attach the shaping disc on the mixing chamber outlet before you assemble the shaping disc holder. Never put the shaping disc in the shaping disc holder and assemble them on the mixing chamber outlet at the same time.

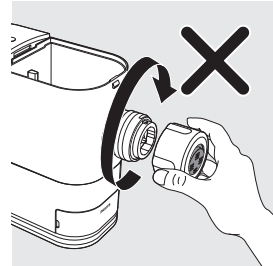

- 7 Attach the lid onto the mixing chamber.

Note:

- If the mixing chamber lid is not properly installed, the safety switch will prevent the appliance from working.

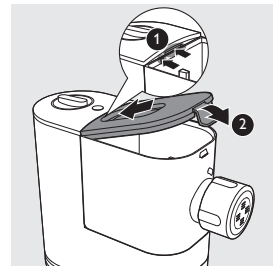

Using the Pasta and noodle maker

Important

- Place the product on a flat surface and prevent table shaking or vibration.
- Make sure all the parts are well assembled before plugging in.
- Do not put less than 200g (1 flour cup) or more than 400g (2 flour cups) of flour in the chamber.
- Pour in the liquid slowly through the water slot after the appliance starts kneading.
- If you want to dispose of the weighed flour before processing with the next batch, empty the chamber and restart the appliance by unplugging and plugging in again.
- Do not put any ingredients that are 60°C / 140°F or above into the Pasta and noodle maker, or place the Pasta and noodle maker in surroundings at high temperature (60°C / 140°F), for instance in a high temperature sterilization environment. This will deform the appliance.
- Never pour water into the mixing chamber before you place the chamber lid onto the chamber.
- Make sure the shaping disc and shaping disc holder are assembled properly before plugging in the appliance.

Preparing the ingredients

- 1 Put the plug of the appliance into the power outlet. The Pasta and noodle maker will sound once.

Note:

- Make sure all the parts are well assembled before plugging in.

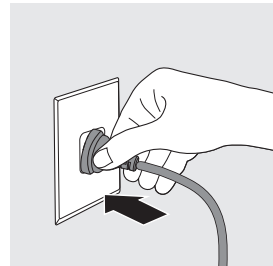

- 2 **1** Pull the lid to unlock it and then **2** remove the lid from the mixing chamber.

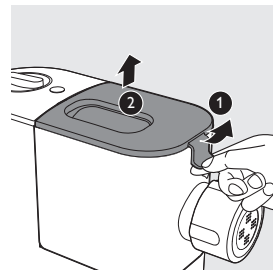

- 3 Scoop one full cup of flour using the flour cup. Scrape off any excessive flour from the cup edge with the supplied flat cleaning tool. One full cup of flour weighs around 200 grams, and is equivalent to 1-2 servings.

Note:

- Do not shake or hit the flour cup to remove excessive flour. This will affect the flour weight.
- Use a kitchen scale to measure the weight more accurately.

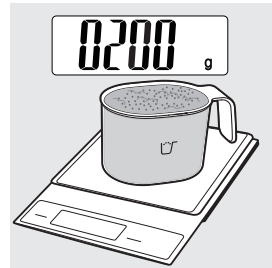
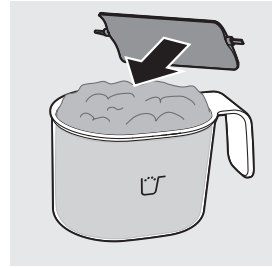

- 4 Pour the flour into the chamber. If you want to make 2-3 servings, add a second cup of flour as you will need 2 cups (~400g) of flour in total.

Note:

- For best result, do not put less than 200 g or more than 400 g of flour in the chamber.
- Do not pour the flour into the opening of the squeezing tube, otherwise the flour in the squeezing tube will not be mixed evenly.

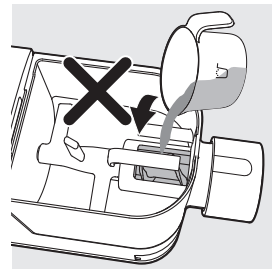
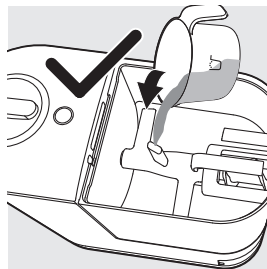
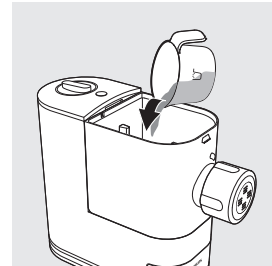

5 Attach the lid onto the mixing chamber.

Note:

- The appliance will not start working if the chamber lid is not properly closed. During the pasta making process, if the chamber lid becomes loose, the appliance will automatically stop working.

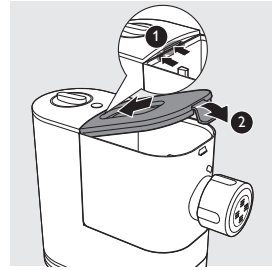

6 Refer to the section “Water and flour ratio” and measure the required amount of water or egg mixture with the supplied water cup.

Note:

- Do not pour water into the mixing chamber before the Pasta and noodle maker starts running.
- Make sure to measure the liquid volume at eye level on a flat surface.

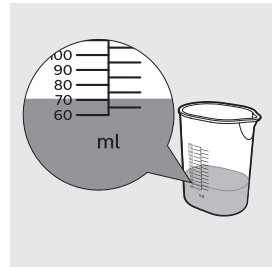

There are 2 sets of water markings on the supplied water cup.

Side A with two liquid levels is **only** designed for plain egg pasta (**all-purpose flour mixed with egg mixture**), which is the most popular pasta.

- 200 g (1 supplied cup) all-purpose flour + 80 ml egg mixture (including 1 egg).
- 400 g (2 supplied cups) all-purpose flour + 160 ml egg mixture (including 2 eggs).

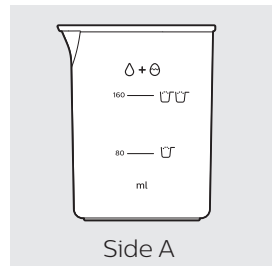

Side B with specific volumes is for other pasta.

- All-purpose flour mixed with pure water/ veggie juice mixture.
- Various other flours (as specified in the table below) with egg mixture/ pure water/ veggie juice mixture, etc.

Check the following table for detailed water and flour ratio.

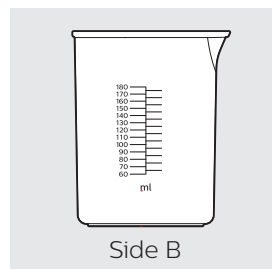

Water and flour ratio

Note:

- This table provides the flour-liquid ratio base on 200 g of flour. When using 400 g of flour to make pasta, double the liquid volume (including egg) to get the right flour-liquid ratio.

Flour	Liquid	Liquid volume	Side A/B
All-purpose flour 200g	Egg mixture(including 1 egg)	80 ml	A
	Pure water	70 ml	B
	Spinach juice	75 ml	B
	Spinach juice+egg mixture (including 1 egg)	75 ml	B
	Beet juice	75 ml	B
	Beet juice+egg mixture (including 1 egg)	80 ml	B
	Carrot juice	75 ml	B
	Carrot juice+egg mixture (including 1 egg)	80 ml	B
	Squid ink egg mixture (including 1 tsp squid ink and 1 egg)	80 ml	B
	Tomato puree+water (including 2 tbsp puree)	75 ml	B
	Tomato puree+egg +water (including 1 tbsp puree and 1 egg)	85 ml	B
	Durum (Semolina flour 150 g + all-purpose flour 50 g)	Egg mixture	75 ml
Pure water		65 ml	B
Spinach juice		70 ml	B
Spinach juice+egg mixture (including 1 egg)		75 ml	B
Beet juice		70 ml	B
Beet juice+egg mixture (including 1 egg)		75 ml	B
Carrot juice		70 ml	B
Carrot juice+egg mixture (including 1 egg)		75 ml	B
Squid ink egg mixture (including 1tsp squid ink and 1 egg)		75 ml	B

Flour	Liquid	Liquid volume	Side A/B
Whole wheat 200 g	Egg mixture (including 1 egg)	90ml	B
	Pure water	80ml	B
Bread flour 200 g	Egg mixture (including 1 egg)	80ml	B
	Pure water	65ml	B
Spelt 200 g	Egg mixture (including 1 egg)	90ml	B
Soba (buckwheat flour 130 g + all-purpose flour 70 g)	Egg mixture (including 1 egg)	80ml	B

Important

- The pasta recipes provided in the recipe book have been tested for success. If you experiment with or use other pasta recipes, the flour and water/egg ratios will need to be adjusted to the flour and water cup ratios included with the Pasta and noodle maker. The Pasta and noodle maker will not operate successfully without adjusting the new recipe accordingly.

Note:

- For best results, use all-purpose flour with the recommended liquid proportions indicated on the cup.
- When making the egg mixture: Crack the egg into the water cup. Add water up to the required amount, and then whisk the water and egg to combine.
- When making the vegetable mixture: Crack the egg into the water cup. Add vegetable juice up to the required amount, and then whisk the juice and egg to combine.
- Whisk the mixture evenly before pouring it into the chamber through the slot in the lid.
- Seasonal changes, using ingredients from different regions may affect the flour/water ratio.
- "Gluten" is a binder which ensures the pasta does not break easily. Gluten-free flour does not contain a binder, therefore it needs a thickener to act as a "binder" eg. Xanthan gum or Guar. Various kinds of gluten-free flour perform differently when making pasta. Some flours are not suitable for making varieties pasta such as coconut flour and white rice flour; some flour varieties work well, such as quinoa and buckwheat.
- See the recipe book provided for more delicious pasta and noodle ideas.

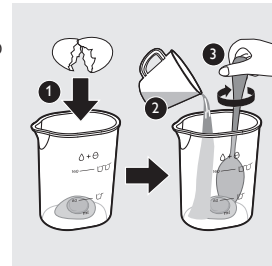

Starting the pasta making program

Important

- Do not select the extra extrusion program before the dough mixing is complete. Otherwise, this will damage the Pasta and noodle maker and its lifetime.
- Do not disconnect the power cord before the processing is complete. If you have to stop the pasta making process, turn the control knob to "OFF" to stop the working process and then disconnect the power cord from outlet before performing other operations.
- Do not exceed the maximum operation cycle of 2 cycles continuously at all applications. To better protect the lifetime of the appliance, you can restart using the appliance after 30 minutes upon 2 continuous operation cycles.
- If you intend to use the appliance continuously, clean each shaping disc with the supplied cleaning tool each time after the pasta making session. For easy cleaning, do not soak the shaping disc directly in water.

- 1 Turn the control knob to **1** select the automatic pasta making process, and then **2** press the Start/Pause button.

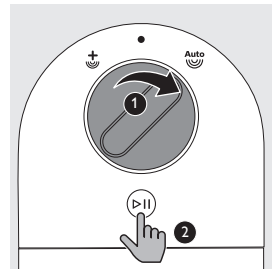

- 2 After the kneading starts, slowly pour in the liquid along the entire length of the slot in the lid.

Note:

- During dough mixing, do not add other ingredients after you have poured in the liquid. Otherwise, it will affect the results of the pasta texture.

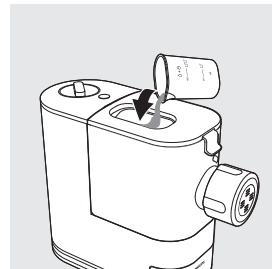

- 3 After the Pasta and noodle maker finishes kneading, it will beep a few times and the pasta extrusion will start after a few seconds. Place a container right under the outlet. Cut the pasta into the desired length with the cleaning tool.

Note:

- If the ratio of liquid and flour is not correct, the extrusion will not succeed. In this case, prepare the ingredients again.
- Move the cleaning tool downwards to cut the pasta.

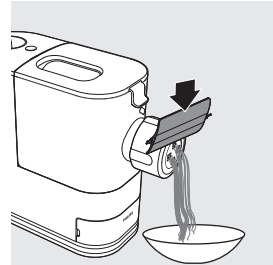

- 4 When the extrusion process is complete, the appliance will beep a few times.

Note:

- Do not turn the control knob to the “OFF” position before the whole process is over (you will hear the “beep” sound).
- The whole working process (including kneading and extruding) takes around 18 minutes for 400g of flour.

- 5 After the pasta making is complete, if you notice some leftover dough inside the chamber, you can ① turn the control knob to the OFF position first, and then ② turn the control knob to the extra-extrusion position. ③ Press the Start/Pause button to start the extra-extrusion program.

Note:

- You may find some fine pasta threads on the pasta surface. This is normal.
- The cooking time of the pasta varies depending on personal preferences, pasta shapes, and number of servings.

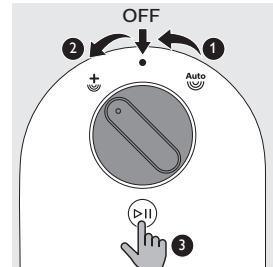

Cleaning

Important

- Turn the control knob to "OFF", disconnect the power and remove the power cord before cleaning or disassembling this appliance.
- Do not immerse the main unit in water.
- Do not use a scouring pad, caustic cleaners, or abrasive cleaners (for examples, gasoline, alcohol, and propanol) to clean the appliance.
- Clean the appliance each time after use, or the appliance might not operate properly.
- Take extra caution when cleaning the appliance to avoid getting cut by any sharp edges.
- The shaping discs and all detachable parts of the appliance are dishwasher safe. When you clean them in a dishwasher, make sure to select the proper program which has a maximum temperature at no higher than 60°C (140°F).

- 1 Turn the control knob to "OFF" and disconnect the plug from the power outlet.

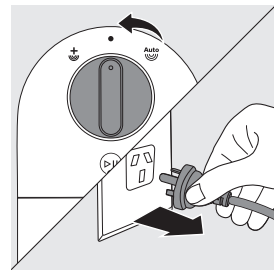

- 2 **1** Pull the lid to unlock it and then **2** remove the lid from the mixing chamber.

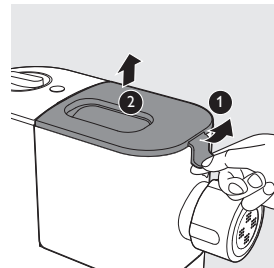

- 3 Slide the mixing chamber off the main unit.

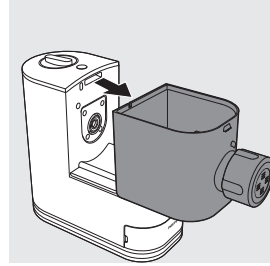

- 4 Turn the shaping disc holder counterclockwise to remove it from the mixing chamber outlet.

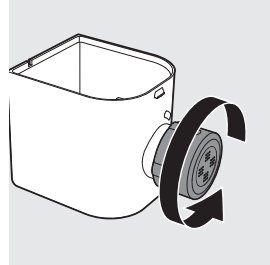

- 5 **1** Put your finger in the mixing chamber and push the squeezing tube outwards to slide it out of the mixing chamber outlet. **2** Detach the shaping disc, and then **3** pull the squeezing bar out of the squeezing tube.

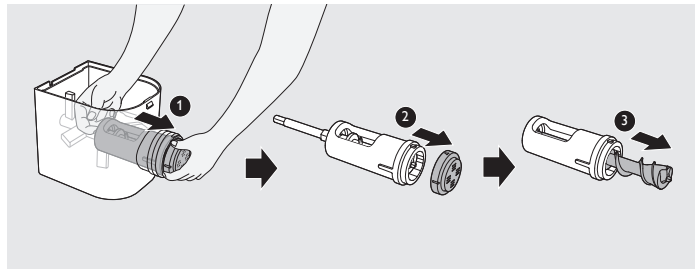

- 6 Take the mixing paddle out of the mixing chamber.

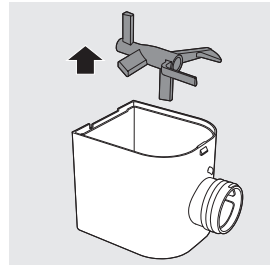

- 7 Clean the shaping disc with the supplied cleaning tool to remove the dough residues. After that, you can clean it with water.

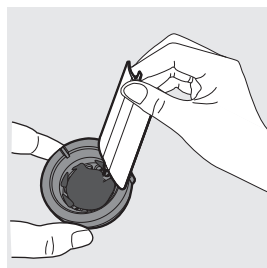
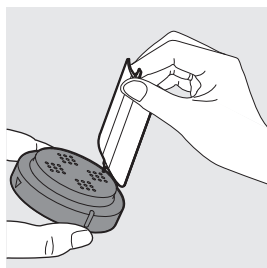

- 8 Clean all detachable parts with dishwashing liquid and warm water or clean in the dishwasher. After that, wipe all parts dry.
- 9 Use a dry cloth to clean the main unit, control knob, and the exterior of the Pasta and noodle maker.

Note:

- After cleaning, make sure all parts and the shaping disc air dry thoroughly before storing. Assemble the Pasta and noodle maker back for next use.



Storage

- 1 Wind the power cord around the cord storage wrap.

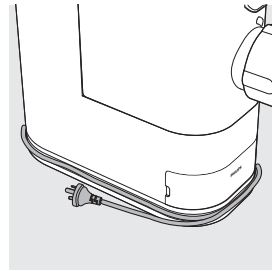

- 2 Dry the shaping discs and store them in the storage box.

The small groove in the storage box is designed for the cleaning tool of the angel hair shaping disc, which is not included in this Pasta and noodle maker. It will be launched and sold separately.

- 3 Store the Pasta and noodle maker in a dry, well ventilated place after use.

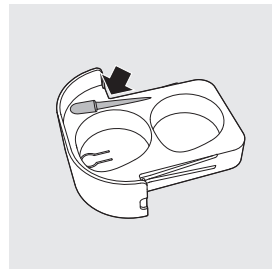



Troubleshooting

This chapter summarizes the most common problems you could encounter with the appliance. If you are unable to solve the problem with the information below, visit www.philips.com/support or refer to page 34 for the consumer care number to call for assistance.

The appliance does not sound after the plug is put in the wall outlet.

- **The plug is not connected properly, or the outlet is not connected to power source.**
Check whether the power plug is plugged correctly and the outlet is working properly.

The appliance does not start the pasta making process after the plug is put in the wall outlet.

- **You have not chosen a pasta making program or pressed the start button .**
Choose a pasta making program and press the start button .

After pressing the start button , the appliance makes alarm sounds and does not work.

- **The chamber lid is not assembled properly.**
Make sure you follow the user manual to assemble the chamber lid properly.

The chamber lid is pushed open from the inside.

- **There's too much flour in the mixing chamber.**
The maximum amount of flour for each batch is 400g. If you have put more than 400g of flour in the mixing chamber, reduce the amount and make another batch of pasta.
- **The ratio of flour and water provided in the "Flour/water ratio table" was not followed. The dough is too wet.**
Disconnect from the power source, clean the Pasta and noodle maker, and follow the user manual again to restart the pasta making.
- **The chamber lid is not assembled properly.**
Make sure you follow the user manual to assemble the chamber lid properly.

During the pasta making process, the appliance stops working, and there is no alarm sound.

- **The Pasta and noodle maker has overheated due to long and continuous working time.**
Disconnect from the power source, and allow the Pasta and noodle maker to cool down. Do not exceed the maximum operation cycle of 2 cycles continuously at all applications. To better protect the lifetime of the appliance, you can restart using the appliance after 30 minutes upon 2 continuous operation cycles.

During the pasta making process, the appliance stops working, and makes alarm sounds.

- **The ratio of flour and water provided in the "Flour/water ratio table" was not followed. The dough may be too dry.**
- **The mixing paddle may be blocked by some foreign objects.**
- **The wrong program is selected.**
Disconnect from the power source, clean the Pasta and noodle maker, and follow the user manual again to restart the pasta making.

The mixing paddle is running idle, and there is no pasta coming out.

- **The ratio of the flour and water is incorrect.**
Disconnect the plug from the power source and discard dough. Clean the Pasta and noodle maker, measure ingredients correctly (use a kitchen scale to measure the flour weight more accurately), and follow the user manual again to restart the pasta making
- **The flour becomes damp after longtime storage.**
Use flour that is fresh or properly stored.

The pasta breaks easily.

- **The ratio of the flour and water is incorrect.**
Disconnect the plug from the power source and discard dough. Clean the Pasta and noodle maker, measure ingredients correctly (use a kitchen scale to measure the flour weight more accurately), and follow the user manual again to restart the pasta making.
- **You did not use the correct type of flour.**
Use all-purpose flour or flour with higher protein content (refer to the chapter 'Using the Pasta and noodle maker' in the user manual or the supplied recipe book).

The pasta sticks together.

- **The ratio of the flour and water is incorrect, too much water is poured in the mixing chamber.**
Measure flour and water with the provided flour and water cup and according to the "flour/water ratio table". Use a kitchen scale to measure the flour weight more accurately.

Too much leftover dough inside the chamber.

- **The flour is either exposed to moisture before use, or the dough is too wet.**
Keep your flour dry during storage. Follow the user manual instructions to restart the pasta making.
- **The chamber, the mixing paddle, the shaping disc are not cleaned properly before use.**
Make sure all parts are clean before use.
- **The mixing paddle or the chamber is still wet.**
Make sure all parts are completely dry before use.
- **Water is not added in the right order.**
The flour type is not suitable.
Follow the user manual instructions to make pasta.

Small amount of water is leaking out from the appliance.

- **Water is added before the program starts.**
Follow the user manual instructions to add water right after the program starts.

After pasta making, the squeezing tube cannot be pushed out of the mixing chamber.

- **The appliance is stopped during extrusion before the pasta making process is finished completely.**
 1. Restore the disassembled parts back in place until the appliance is assembled properly, and turn the control knob to the OFF position.
 2. Plug in, select the automatic pasta making program, and press the start button. Keep the mixing paddle rotating for around 10 seconds, and then turn the control knob to the OFF position.
 3. Unplug the appliance, disassemble and clean the appliance as described in the user manual (see chapter "cleaning").

Product information

Model	HR2342
Motor power	150W
Rated voltage	AC220-240V (50Hz)
Dimensions (L x W x H)	350 mm x 135 mm x 287 mm
Net weight	4.7 kg

- For rated voltage and frequency information, refer to the type plate on the product. Product information is subject to change without prior notice.

Components	Mixing chamber	Lid	Mixing paddle / squeezing bar	Shaping discs
Material	Tritan	Tritan	POM	POM

Recycling

Do not throw away the product with the normal household waste at the end of its life, but hand it in at an official collection point for recycling. By doing this, you help to preserve the environment.

Abbreviations
g = grams
~ = approximately
ml = milliliters
mm = millimeters
kg = kilogram

Warranty

2-YEAR WARRANTY

IMPORTANT:

Please keep this warranty card
together with your proof of
purchase for use when claiming.

AUSTRALIA

Philips Consumer Care: 1300 363 391
Website: www.philips.com/support

NEW ZEALAND

Philips Consumer Care: 0800 658 224
Website: www.philips.com/support

PHILIPS

Philips Electronics Australia Limited and Philips New Zealand Commercial Limited Warranty against Defects

In this warranty:

We or **us** means Philips Electronics Australia Limited ACN 008 445 743 or Philips New Zealand Commercial Limited NZBN: 9429041782170, and our contact details are set out at the end of this warranty;

You means the purchaser or the original end-user of the Goods;

Supplier means the authorised distributor or retailer of the Goods that sold you the Goods in Australia or New Zealand; and

Goods means the product or equipment which was accompanied by this warranty and purchased in Australia or New Zealand.

If you require assistance with the operation of the product, its features or specifications please call the Philips Consumer Care Centre on 1300 363 391 in Australia or 0800 658 224 in New Zealand.

Australia: Our Goods come with guarantees that cannot be excluded under the Australian Consumer Law. You are entitled to a replacement or refund for a major failure and for compensation for any other reasonably foreseeable loss or damage. You are also entitled to have the Goods repaired or replaced if the goods fail to be of acceptable quality and the failure does not amount to a major failure. This is not a complete statement of your legal rights as a consumer.

New Zealand: Our Goods come with guarantees that cannot be excluded under the Consumer Guarantees Act 1993. This guarantee applies in addition to the conditions and guarantees implied by that legislation.

Additional Warranty:

In addition to the rights and remedies that you have under the Australian Consumer Law, Consumer Guarantees Act of New Zealand or any other applicable law, we provide the following warranty against defects:

1. If, during the first **2 years** from their date of purchase from the Supplier (**Warranty Period**), the Goods prove defective by reason of improper workmanship or materials and none of your statutory rights or remedies apply, we will repair or replace the Goods without charge.

PHILIPS

2. We do not have to repair or replace the Goods under this Additional Warranty if the Goods have been used for a commercial purpose; misused, improperly or inappropriately installed, operated or repaired; abused; damaged; or not maintained in accordance with the manufacturer's instructions.
3. Even when we do not have to repair or replace the Goods, we may decide to do so anyway. In some cases, we may decide to substitute the Goods with a similar alternative product of our choosing. All such decisions are at our absolute discretion.
4. All such repaired, replaced or substituted Goods continue to receive the benefit of this Additional Warranty for the time remaining on the original Warranty Period.
5. This Additional Warranty is limited to repair, replacement or substitution only. As far as the law permits, we will not be liable for any loss or damage caused to property or persons arising from any cause whatsoever.
6. In order to claim under this Additional Warranty you must telephone us on 1300 363 391 in Australia or 0800 658 224 in New Zealand within the Warranty Period. You will be asked for details of the Goods, a description of the defect and your personal details. Upon accepting your claim, we shall assist you with either returning the Goods to the Supplier for replacement or to the most convenient Philips Authorised Service Centre for your Goods to be repaired. In some case we may require that you return to the Goods to us (at the address below) for repair, replacement or substitution.
 - All returned Goods must be accompanied by satisfactory proof of purchase which clearly indicates the name and address of the Supplier, the date and place of purchase and identifies product. It is best to provide a legible and unmodified receipt or sales invoice.
 - You must bear any expense for return of the Goods or otherwise associated with making your claim under this Additional Warranty.
7. This warranty is only valid and enforceable in Australia and New Zealand.

Contact us or the place of purchase for further details.

Philips Electronics Australia Limited
65 Epping Road North Ryde
North Ryde SYDNEY NSW 2113

Consumer Care: 1300 363 391

Website: www.philips.com/support

Philips New Zealand Commercial Limited
Level 3, 123 Carlton Gore Road
Newmarket AUCKLAND 1023

Consumer Care: 0800 658 224

Website: www.philips.com/support



4222.005.0272.4

目录

重要信息	38
包装盒内物品	41
概览	42
首次使用前的拆卸和清洁	44
组装	46
使用意面 / 面条机	49
清洁	56
存储	59
故障排除	60
产品信息	63
回收	63

重要信息

安全

使用本产品之前，请仔细阅读本用户手册，并妥善保管以备日后参考。

警告

- 在将产品连接到电源之前，确保产品底部上标示的电压与当地的电源电压相符。
- 将插头插入电源插座之前，双手要保持干燥。
- 请勿将主装置浸入水中，或用水或其他液体冲洗。
- 为防止短路或触电，请勿让水或任何液体流入产品中。
- 确保插头牢固插入电源插座。
- 切勿将本产品连接到定时器或单独的遥控系统。
- 将插头插入电源插座之前，确保正确组装产品。
- 如果电源线、插头或其他部件受损，请勿再使用本产品。
- 在不使用、无人看管时，或在拆装、清洁或存放前，请确保控制旋钮处于关闭位置 (OFF)，且已拔下产品的电源插头。在将插头接入墙上插座和操作产品之前，请务必确保产品已正确组装。本产品只有在正确组装的情况下才会正常工作。
- 切勿将手、手指或器皿放入产品搅拌容器，除非控制旋钮处于关闭位置 (OFF)，已拔下产品的电源插头，且马达和搅拌叶片已完全停止。确保马达和搅拌叶片已完全停止，然后再拆卸、清洁或存放。
- 如果电源线损坏，为避免危险，必须由飞利浦或其授权的服务中心，或类似的专职人员进行更换。
- 请勿自行更换产品部件。
- 儿童不得使用本产品。将产品及其电源线放在儿童接触不到的地方。

警告

- 本产品不打算由肢体不健全、感觉或精神上有障碍或缺乏相关经验和知识的人（包括儿童）使用，除非有负责他们安全的人对他们使用本产品进行监督或指导。
- 应照看好儿童，避免他们玩耍本产品。
- 为防止发生意外，如果产品因任何原因发生损坏，请勿再使用。

注意

- 首次使用产品之前，拆卸并彻底清洗附件（请参阅“首次使用前的拆卸和清洁”一章。）
- 本产品仅限于家用。
- 切勿使用由其他制造商生产或未经飞利浦特别推荐的任何附件或部件。如果使用此类附件或部件，您的保修将失效。
- 请勿在不稳固或不平坦的表面上使用本产品。
- 加工完成之前，请勿拔掉电源线。如果必须停止加工，请先拔掉电源线再执行其他操作。
- 在所有工作状态下，最长运转周期不得超过 2 个连续周期。为更好地延长产品使用寿命，您可以在 2 个连续运转周期后休息 30 分钟再重新启动本产品。
- 如果要连续使用产品，请在每次使用后用随附的清洁工具清洁塑形模块。
- 请勿强行弯折、猛拉、扭曲或捆扎电源线，也不要将其置于重物下。
- 不用时要拔下产品的插头。
- 请勿在桌布或布帘等易燃物附近使用产品。

注意

- 发现冒烟后请立即拔出电源插头。
- 拔出电源线时不要拉扯线缆，而要抓住插头部分。
- 请保持电源插头洁净。
- 请勿将重物放在产品上。
- 本产品旨在作为厨房用具使用。请勿将产品用于任何其他用途。
- 请勿在使用期间移动本产品。
- 产品处于无人看管时、拆装或清洁之前，请拔掉电源线。
- 使用后，将产品置于干燥和通风良好的地方。
- 切勿通过抓住塑形模块支架握住和移动产品。请抓住主装置来这样做。
- 每次使用之前，请确保塑形模块孔未堵塞。
- 在操作过程中保持双手、头发、衣服以及厨具和其他器皿远离本产品，从而减少人身伤害和 / 或损坏本产品的风险。
- 在意面 / 面条机运行期间，请勿将手指或其它物体放入意面 / 面条机出面口处。避免接触活动部件。
- 切勿尝试破坏上盖互锁机制。
- 产品的塑形模块及所有可拆卸部件均可用洗碗机清洗。用洗碗机清洗时，确保选择最高温度不超过 60°C (140°F) 的合适程序。
- 仅使用正确接地的插座。

电磁场 (EMF)

本飞利浦产品符合所有有关暴露于电磁场的适用标准和法规。

感谢您的惠顾，欢迎光临飞利浦！
为了让您能充分享受飞利浦提供的支持，请在 www.philips.com/welcome 上注册您的产品。
在安装和使用产品之前，请仔细阅读本用户手册。妥善保管以供日后参考。

包装盒内物品

主装置

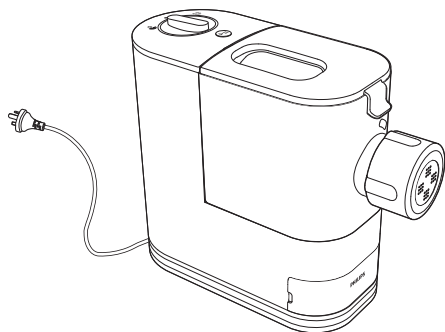

用户手册



食谱



扁平清洁工具



面粉杯



水杯



意大利面 /
细面 *

塑形模块:



意大利宽面 /
板面



意大利通心粉



* 意大利面 / 细面塑形模块在您购买产品时已经组装在产品上。

概览

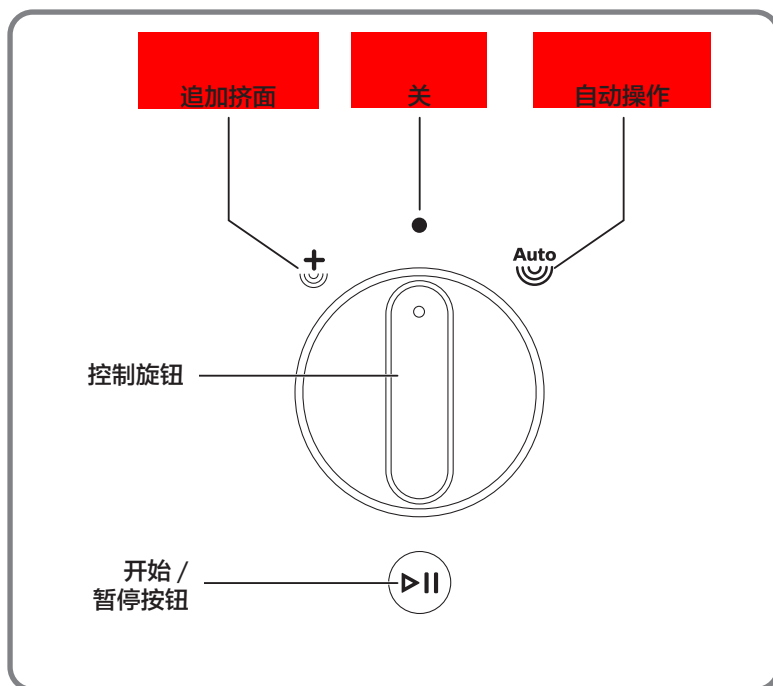
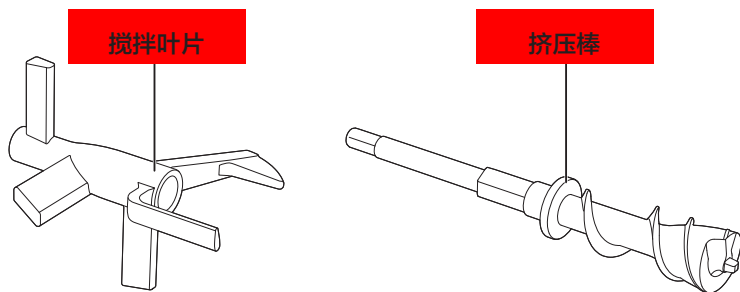

挤压管

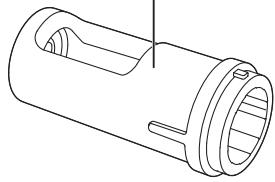

塑形模块

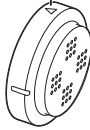

塑形模块支架

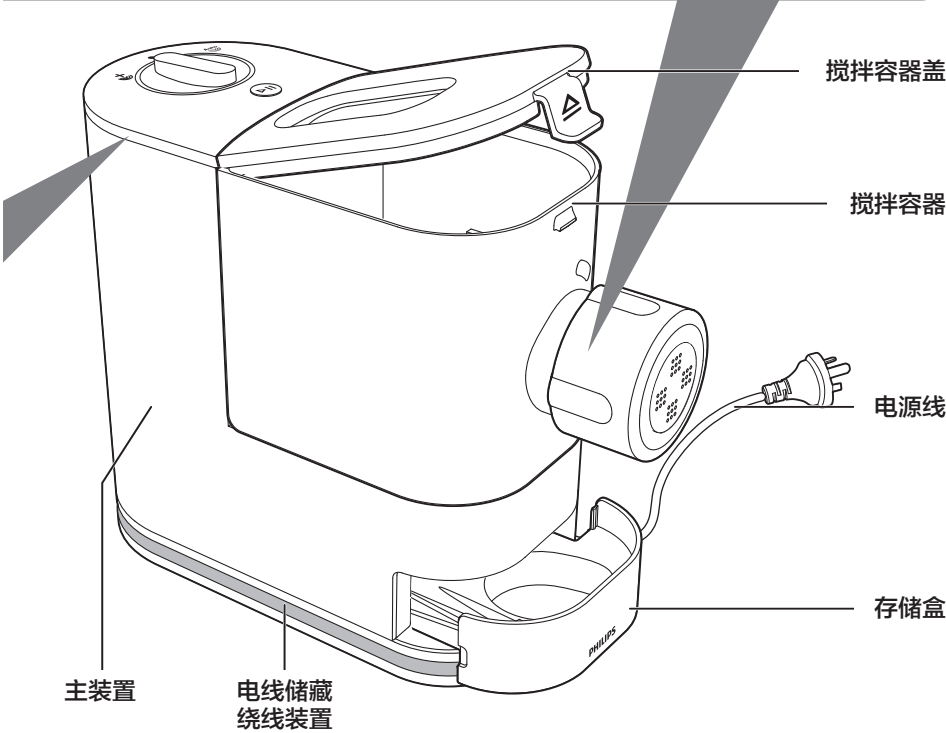
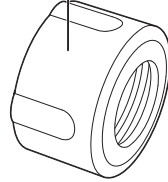

搅拌容器盖

搅拌容器

电源线

存储盒

主装置

电线储藏
绕线装置

首次使用前的 拆卸和清洁

重要信息

- 第一次使用产品前，请拆下并安全弃置任何包装材料和 / 或促销标签。
- 取出所有可拆卸部件和附件，清洗并彻底干燥所有部件和附件（请参阅“清洁”一章）。
- 请勿用水冲洗或浸泡主装置、电源线或电源插头。
- 请勿使用钢丝绒或类似的清洁工具，以免刮花意面 / 面条机的塑料表面和影响使用寿命。
- 产品的塑形模块及所有可拆卸部件均可用洗碗机清洗。用洗碗机清洗时，确保选择最高温度不超过 60°C (140°F) 的合适程序。
- 本产品仅限于家用。

- 1 ① 拉开盖子将其解锁，然后 ② 从搅拌容器上取下盖子。

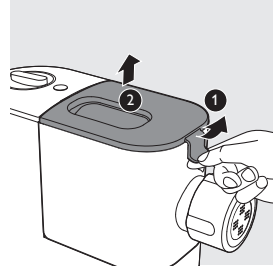

- 2 将搅拌容器从主装置上滑出。

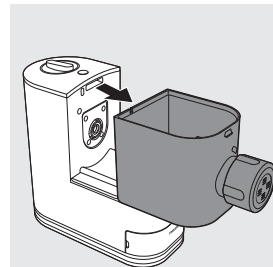

- 3 逆时针转动塑形模块支架，将其从搅拌容器出门口上卸下。

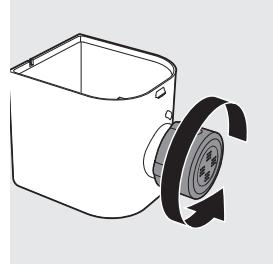

- 4 ① 将您的手指放入搅拌容器中，并向外推动挤压管，将其从搅拌容器出门口滑出。
② 拆下塑形模块，③ 然后将挤压棒从挤压管中拉出。

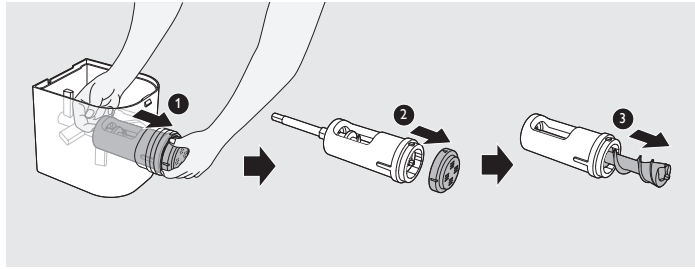

- 5 将搅拌叶片从搅拌容器取出。

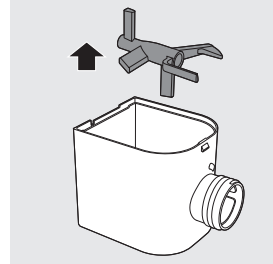

- 6 清洁所有可拆卸部件和附件，然后将其擦干。

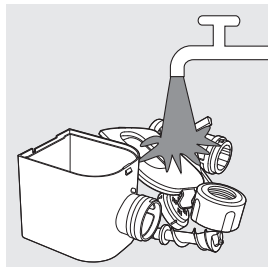

组装

按照以下组装步骤安装意面 / 面条机。

重要信息

- 组装时确保产品不要通电。

- 1 将搅拌容器滑到主装置上。

注意：

- 请确保主装置上的 ❶ 固定杆正确插入搅拌容器底部的开口。

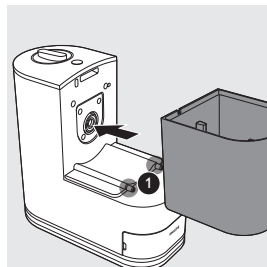

- 2 如图所示，将搅拌叶片放入搅拌容器中。

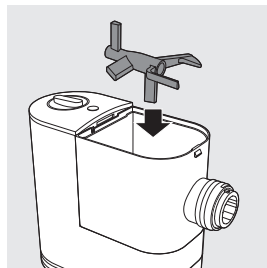

- 3 将挤压管插入搅拌容器中。

注意：

- 在将挤压管插入搅拌容器中时，请确保挤压管上的大开口朝上。

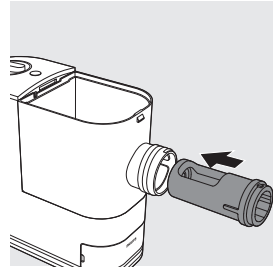

- 4 将挤压棒插入搅拌容器中。确保挤压棒穿过挤压管和搅拌叶片一直滑入到主装置中的驱动轴中。

注意：

- 轻轻转动搅拌叶片，确保挤压棒正确连接到 **①** 主装置的驱动轴上。

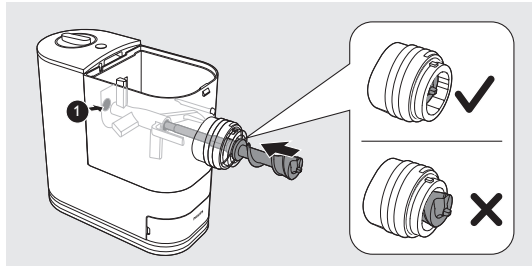

- 5 将塑形模块固定到搅拌容器出面口上。

注意：

- 确保塑形模块的平面朝外。
- 确保塑形模块装入挤压棒的固定点。
- 在将塑形模块固定到搅拌容器出面口上时，确保塑形模块的箭头面朝上。

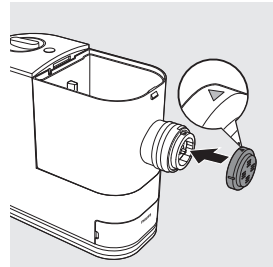

- 6 ① 用手指穿过塑形模块支架并按住塑形模块，然后将支架组装在搅拌容器出面口上。
② 顺时针旋转支架将其牢固地锁定就位。

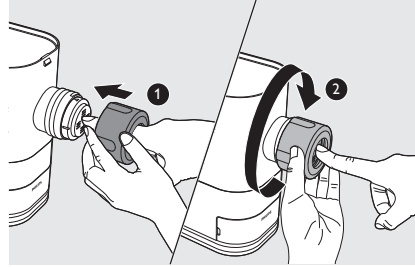

在组装塑形模块支架前，始终将塑形模块固定在搅拌容器出面口上。请勿同时将塑形模块放入塑形模块支架并将其安装在搅拌容器出面口上。

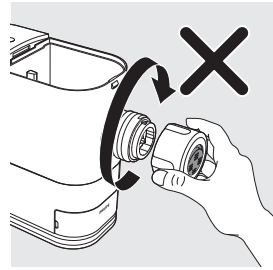

- 7 盖好搅拌容器盖。

注意：

- 如果搅拌容器盖安装不正确，安全开关会阻止产品工作。

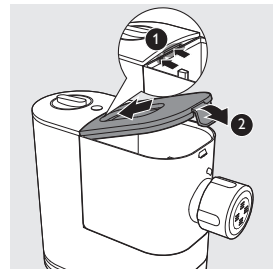

使用意面 / 面条机

重要信息

- 将产品置于平坦的表面上并防止桌子晃动或振动。
- 产品通电之前，确保所有部件均已装好。
- 请勿将不足 200 克（1 面粉杯）或超过 400 克（2 面粉杯）的面粉放入搅拌容器。
- 产品开始和面后，通过水槽缓慢倒入液体。
- 如果要弃置已称量的面粉，然后再加工下一批面粉，请清空搅拌容器并拔下电源插头，然后再次插入插头，重启产品。
- 请勿将 60°C / 140°F 或以上温度的原料放入意面 / 面条机，也不要将意面 / 面条机放在高温（60°C / 140°F）环境中，例如高温消毒环境。这样会使产品变形。
- 在盖好搅拌容器盖之前，请勿向搅拌容器注水。
- 插入产品电源插头前，确保塑形模块和塑形模块支架均已正确组装。

准备原料

- 1 将产品插头插入电源插座。意面 / 面条机会响一声。

注意：

- 产品通电之前，确保所有部件均已装好。

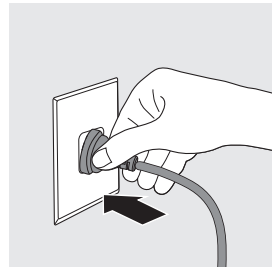

- 2 **①** 拉开盖子以将其解锁，然后**②**从搅拌容器上取下盖子。

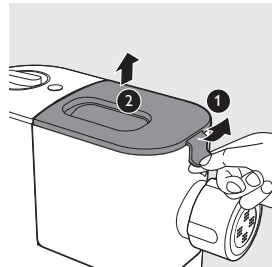

- 3 使用面粉杯舀一满杯面粉。使用提供的扁平清洁工具，沿杯缘刮去多余的面粉。一满杯面粉重约 200 克，相当于 1-2 人份。

注意：

- 不要通过晃动或击打面粉杯来去除多余的面粉。这会影 响面粉重量。
- 使用厨房秤，称量结果会更加准确。

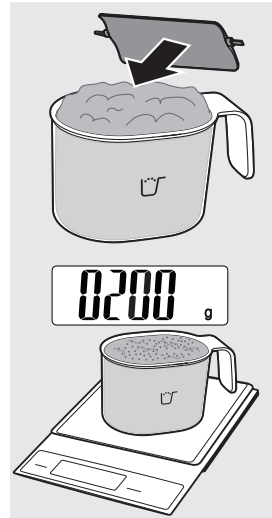

- 4 将面粉倒入搅拌容器。如果要制作 2-3 人份，请再添 加一杯面粉，因为总共需要 2 杯（约 400 克）面粉。

注意：

- 为获得最佳品质，请勿将不足 200 克重或超过 400 克重 的面粉放入搅拌容器。
- 请勿将面粉倒入挤压管的开口中，否则挤压管中的面 粉无法混合均匀。

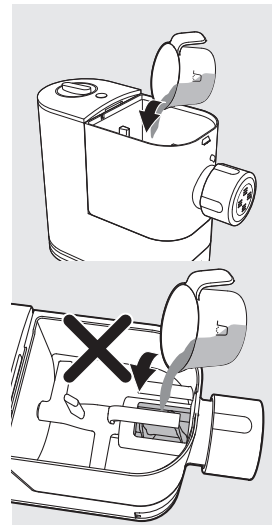
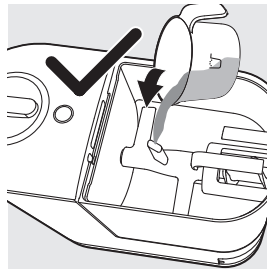

5 盖好搅拌容器盖。

注意：

- 如果搅拌容器盖未盖好，产品不会开始工作。在意大利制作期间，如果搅拌容器盖出现松动，产品会自动停止工作。

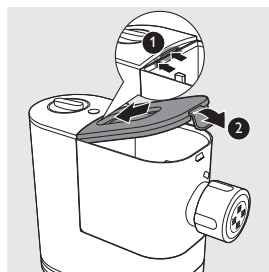

6 请参阅“水和面粉比例”部分，用随附的水杯量取适量的水或蛋混合物。

注意：

- 运行意大利 / 面条机之前，请勿将水倒入搅拌容器。
- 确保在平坦表面上以齐眼高度量取液体容量。

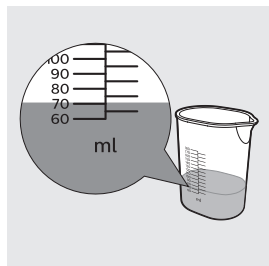

随附的水杯上有 2 种水位标记。

A 面有两种液体水位，只适用于制作最受欢迎的普通鸡蛋意大利面（家用面粉和蛋糊混合而成）。

- 200 克（1 随附量杯）家用面粉 + 80 毫升蛋糊（包括 1 个鸡蛋）。
- 400 克（2 随附量杯）家用面粉 + 160 毫升蛋糊（包括 2 个鸡蛋）。

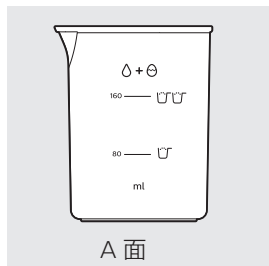

A 面

B 面有具体种类的液体水位，适用于制作其它意大利面。

- 家用面粉和纯净水 / 蔬菜汁混合而成。
- 其它种类面粉（如下表所示）和蛋糊 / 纯净水 / 蔬菜汁等混合而成。

查看下表了解详细的水和面粉比例。

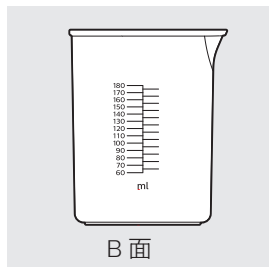

B 面

水和面粉比例

注意：

- 该表基于 200 克面粉提供面粉 - 液体比例。在使用 400 克面粉制作意面时，将液体容量（包括鸡蛋）加倍以获得正确的面粉 - 液体比例。

面粉	液体	液体容量	A 面 / B 面
家用面粉 200 克	蛋糊（包括 1 个鸡蛋）	80 毫升	A
	纯净水	70 毫升	B
	菠菜汁	75 毫升	B
	菠菜汁 + 蛋糊 （包括 1 个鸡蛋）	75 毫升	B
	甜菜汁	75 毫升	B
	甜菜汁 + 蛋糊 （包括 1 个鸡蛋）	80 毫升	B
	胡萝卜汁	75 毫升	B
	胡萝卜汁 + 蛋糊 （包括 1 个鸡蛋）	80 毫升	B
	墨鱼汁鸡蛋混合物 （包括 1 茶匙墨鱼汁和 1 个鸡蛋）	80 毫升	B
	番茄泥 + 水 （包括 2 汤匙番茄泥）	75 毫升	B
	番茄泥 + 鸡蛋 + 水 （包括 1 汤匙番茄泥和 1 个鸡蛋）	85 毫升	B
硬粒小麦（粗粒面粉 150 克 + 家用面粉 50 克）	蛋糊	75 毫升	B
	纯净水	65 毫升	B
	菠菜汁	70 毫升	B
	菠菜汁 + 蛋糊 （包括 1 个鸡蛋）	75 毫升	B
	甜菜汁	70 毫升	B
	甜菜汁 + 蛋糊 （包括 1 个鸡蛋）	75 毫升	B
	胡萝卜汁	70 毫升	B
	胡萝卜汁 + 蛋糊 （包括 1 个鸡蛋）	75 毫升	B
墨鱼汁鸡蛋混合物 （包括 1 茶匙墨鱼汁和 1 个鸡蛋）	75 毫升	B	

面粉	液体	液体容量	A 面 /B 面
全麦面包 200 克	蛋糊 (包括 1 个鸡蛋)	90 毫升	B
	纯净水	80 毫升	B
面包粉 200 克	蛋糊 (包括 1 个鸡蛋)	80 毫升	B
	纯净水	65 毫升	B
斯佩尔特小麦 200 克	蛋糊 (包括 1 个鸡蛋)	90 毫升	B
荞麦面 (荞麦粉 130 克 + 家用面粉 70 克)	蛋糊 (包括 1 个鸡蛋)	80 毫升	B

重要信息

- 食谱中提供的意面配方均已经过测试，可成功制作一份成品。如果您试验或使用其他意面配方，那么面粉和水 / 蛋比例需要调整到意面 / 面条机随附的面粉和水杯比例。若不相应调整新配方，意面 / 面条机将不会成功运转。

注意：

- 为获得最佳品质，请使用中筋面粉并根据水杯上推荐的液体比例制作意面。
- 制作蛋糊方法：
将鸡蛋打碎，倒入水杯中。加入所需水量，然后将水和鸡蛋搅拌混合。
- 制作蔬菜混合物方法：
将鸡蛋打碎，倒入水杯中。加入所需蔬菜汁量，然后将蔬菜汁和鸡蛋搅拌混合。
- 确保将蛋糊搅拌均匀后再将其沿着盖中的槽沟倒入搅拌容器。
- 时令和使用不同地区所用的原料可能会影响面 / 水比例。
- “麦麸”是确保意面不易断裂的粘结剂。无麦麸面粉不含粘结剂，因此需要一种增稠剂（例如黄原胶、瓜尔豆等）充当“粘结剂”的角色，在制作意面时各种无麦麸面粉的表现不同。有些面粉不适合制作各种意面，如椰子粉和白面粉；有些面粉品种则非常适合，如藜麦、荞麦等。
- 请参阅随附的食谱了解更多美味意面的做法。

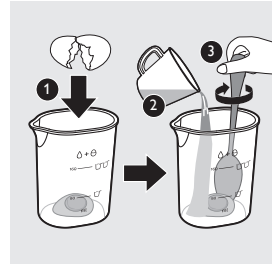

启动意面制作程序

重要信息

- 在和面完成前，请勿选择追加挤面程序。否则，这会损坏意面 / 面条机，缩短其使用寿命。
- 加工完成之前，请勿拔掉电源线。如果必须停止意面制作过程，请将控制旋钮转至关闭位置 (OFF) 以停止制作过程，然后从插座上拔下电源线，之后再执行其他操作。
- 在所有工作状态下，最长运转周期不得超过 2 个连续周期。为更好地延长产品使用寿命，您可以在 2 个连续运转周期后休息 30 分钟再重新启动本产品。
- 如果要连续使用产品，请在每次制作意面后，用随附的清洁工具清洁塑形模块。为便于清洗，请不要将塑形模块直接浸入水中。

- 1 转动控制旋钮 ① 可选择自动制作意面流程，然后 ② 按下开始 / 暂停按钮。

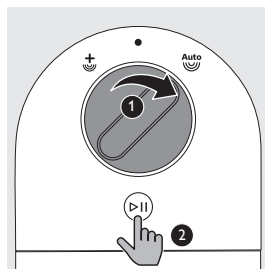

- 2 和面开始后，沿着盖中的整个槽沟缓慢倒入液体。

注意：

- 和面过程中，倒入液体后就不要再加入其他原料。否则，会影响最终的意面质地。

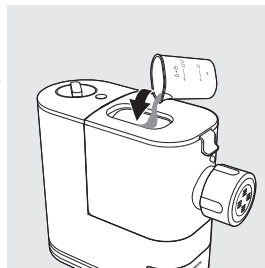

- 3 意面 / 面条机完成和面后，会发出几声蜂鸣音，几秒钟后将开始挤出意面。将容器放在出面口正下方。用清洁工具将意面切至所需的长度。

注意：

- 如果液体和面粉的比例不正确，挤出不会成功。这种情况下，请重新准备原料。
- 向下移动清洁工具可切削意面。

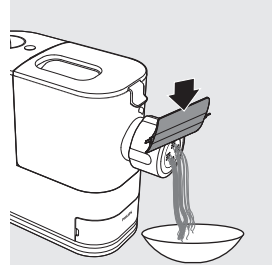

- 4 挤出过程完成后，产品会发出几声蜂鸣音。

注意：

- 在整个过程完成前（您将会听到蜂鸣音），请勿将控制旋钮转至关闭位置 (OFF)。
- 加工 400 克面粉时，整个工作过程（包括和面和挤压成形）需要 18 分钟。

- 5 意面制作完成后，如果发现搅拌容器中有一些剩面，您可以 ① 先将控制旋钮转至关闭位置 (OFF)，然后 ② 将控制旋钮转到追加挤面位置。③ 按下开始 / 暂停按钮以启动超强挤出程序。

注意：

- 意面表面可能会有一些意面细丝。这是正常的。
- 意面的烹饪时间不固定，具体应取决于个人偏好、意面形状以及份量。

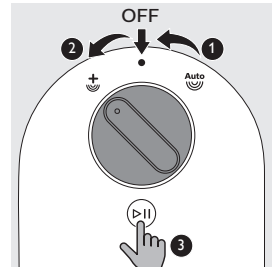

清洁

重要信息

- 清洁或拆卸本产品之前，请将控制旋钮转至关闭位置 (OFF)，断开电源并拔出电源线。
- 请勿将主装置浸入水中。
- 请勿使用钢丝绒、碱性洗涤剂或磨蚀性清洁剂（例如汽油、酒精和丙醇）清洁产品。
- 每次使用后都要清洁产品，否则产品可能无法正常运行。
- 清洁产品时要加倍小心，以免被任何锋利边缘割伤。
- 产品的塑形模块及所有可拆卸部件均可用洗碗机清洗。用洗碗机清洗时，确保选择最高温度不超过 60°C (140°F) 的合适程序。

- 1 将控制旋钮转至关闭位置 (OFF)，断开电源并拔出电源线。

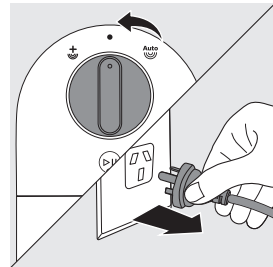

- 2 ① 拉开盖子以将其解锁，然后 ② 从搅拌容器上取下盖子。

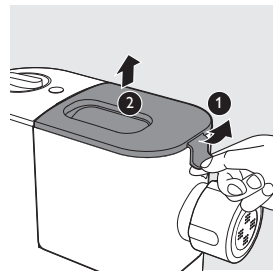

- 3 将搅拌容器从主装置上滑出。

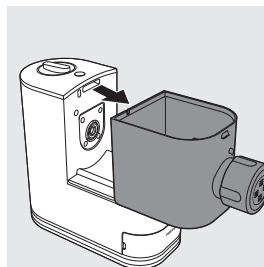

- 4 逆时针转动塑形模块支架，将其从搅拌容器出面上卸下。

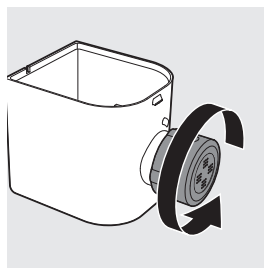

- 5 ① 将您的手指放入搅拌容器中，并向外推动挤压管，将其从搅拌容器出面口滑出。② 拆下塑形模块，③ 然后将挤压棒从挤压管中拉出。

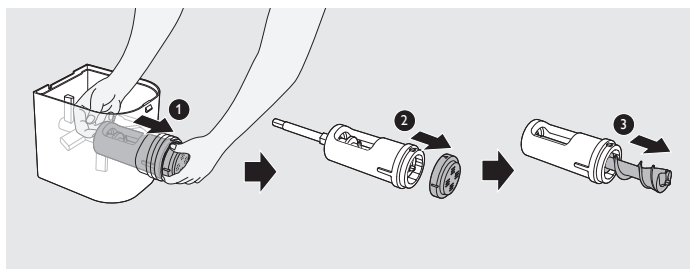

- 6 将搅拌叶片从搅拌容器取出。

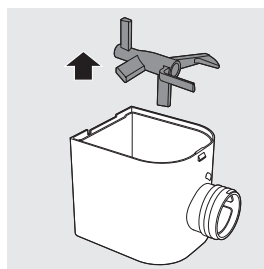

- 7 使用随附的清洁工具清洁塑形模块，清除残留的面。之后可以用水进行清洗。

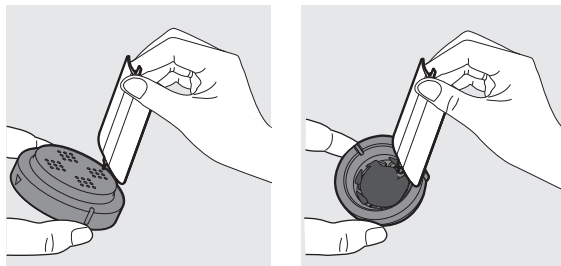

- 8 用清洁剂和温水清洗所有可拆卸部件，或在洗碗机中清洗。接下来，擦干所有部件。

- 9 使用干布清洁主装置、控制旋钮以及意面 / 面条机的外表面。

注意：

- 清洁后，确保将所有部件和塑形模块完全晾干后再进行存储。重新组装意面 / 面条机以备下次使用。



存储

- 1 将电源线缠绕在电源线储藏绕线装置中。

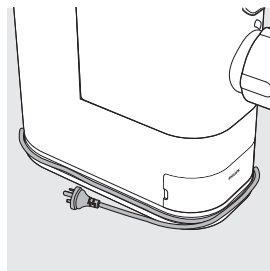

- 2 晾干塑形模块并将其存放在存储盒中。

存储盒中较小的沟槽专为天使细面条塑形模块的清洁工具而设计，该工具未包含在此意面 / 面条机中。它将单独推出与出售。

- 3 使用后，请将意面 / 面条机存放在干燥、通风良好的地方。

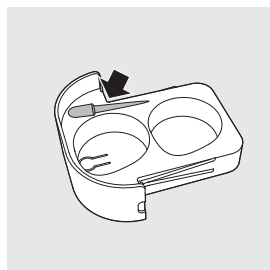



故障排除

本章归纳了您在使用产品时最常遇到的问题。如果根据以下信息无法解决问题，请访问 www.philips.com/support，或参阅第 34 页查找客服号码，以便呼叫求助。

将插头插入墙上插座后，产品不会发出声音。

- **未正确连接插头，或插座未连接至电源。**
检查电源插头是否插好，插座是否可以正常使用。

必须先将插头插入墙上插座，本产品才能开始意面制作过程。

- **您未选择意面制作程序或未按下开始按钮 **。
选择意面制作程序，然后按下开始按钮 。

按下开始按钮后 ，若产品发出警报声便无法工作。

- **搅拌容器盖没有正确组装。**
确保按照用户手册正确组装搅拌容器盖。

搅拌容器盖从内侧推开。

- **搅拌容器中面粉过多。**
每次可用最大面粉量为 400 克。如果您在搅拌容器中放入超过 400 克面粉，请减少面粉量并制作另一批意面。
- **未按照“面 / 水比例表”中的面粉和水的比例。面团太湿。**
断开电源，清洁意面 / 面条机，再次按照用户手册中的说明重新开始制作意面。
- **搅拌容器盖没有正确组装。**
确保按照用户手册正确组装搅拌容器盖。

意面制作过程中，产品停止工作，并且没有发出警报声。

- **意面 / 面条机因长时间连续工作而过热。**
断开电源，让意面 / 面条机冷却。在所有工作状态下，最长运转周期不得超过 2 个连续周期。为更好地延长产品使用寿命，您可以在 2 个连续运转周期后休息 30 分钟再重新启动本产品。

意面制作期间，产品停止工作，并发出警报声。

- **未按照“面 / 水比例表”中的面粉和水的比例。面团可能太干。**
- **搅拌叶片可能被一些异物阻塞。**
- **选择了错误的程序。**
断开电源，清洁意面 / 面条机，再次按照用户手册中的说明重新开始制作意面。

搅拌叶片空转，不出意面。

- **面 / 水比例不正确。**
从电源插座上拔出插头，弃置面团。清洁意面 / 面条机，正确称量原料份量（使用厨房秤可以更准确地称量面粉重量），再次按照用户手册中的说明重新开始制作意面
- **面粉在长期存放后变得潮湿。**
使用新鲜或正确存放的面粉。

意面轻易断裂。

- **面 / 水比例不正确。**
从电源插座上拔出插头，弃置面团。清洁意面 / 面条机，正确称量原料份量（使用厨房秤可以更准确地称量面粉重量），再次按照用户手册中的说明重新开始制作意面。
- **您没有使用正确类型的面粉。**
使用家用面粉或蛋白质含量较高的面粉（请参阅用户手册“使用意面 / 面条机”一章或随附的食谱）。

意面粘在一起。

- **面粉和水的比例不正确，搅拌容器中的水太多。**
根据“面 / 水比例表”使用随附的面粉和水杯测量面粉和水。使用厨房秤可以更准确地称量面粉重量。

搅拌容器中剩面过多。

- **面粉在使用前已受潮或面团太湿。**
存储时使用面粉保持干燥。按照用户手册中的说明重新开始制作意面。
- **使用之前未正确清洁搅拌容器、搅拌叶片、塑形模块。**
使用之前，确保所有部件洁净。
- **搅拌叶片或搅拌容器仍然是湿的。**
使用之前，确保所有部件完全干燥。
- **未按正确的顺序加水。**
面粉种类不正确。
按照用户手册中的说明制作意面。

产品有少量漏水。

- **程序开始之前已经加水。**
按照用户手册说明，在程序开始后再加水。

意面制作完成后，无法将挤压管从搅拌容器中推出。

- **在意面制作过程完成之前，在挤出过程中产品停止运行。**
 1. 将已拆卸部件复原到位直到产品正确组装，然后将控制旋钮转至关闭位置 (OFF)。
 2. 将插头接入插座，选择自动意面制作程序，然后按下开始按钮。保持搅拌叶片旋转约 10 秒钟，然后将控制旋钮转至关闭位置 (OFF)。
 3. 拔下产品插头，然后按用户手册（请参阅“清洁”一章）所述拆卸并清洁产品。

产品信息

型号	HR2342
电机功率	150 瓦
电压	交流 220 - 240 伏 (50 赫兹)
尺寸 (长 x 宽 x 高)	350 毫米 x 135 毫米 x 287 毫米
净重	4.7 千克

- 有关额定电压和频率信息，请参阅产品上的铭牌。产品信息如有更改，恕不另行通知。

产品部件	搅拌容器	搅拌容器盖	搅拌叶片 / 挤压杆	塑形模块
制造材料	Tritan	Tritan	POM	POM

回收

弃置产品时，请不要将它与一般生活垃圾一同丢弃，应将其交给官方指定的回收中心。这样做有利于环保。

缩写

g = 克

~ = 大约

ml = 毫升

mm = 毫米

kg = 千克



Specifications are subject to change without notice
© 2016 Koninklijke Philips N.V.
All rights reserved.