

Panasonic®

Basic Owner's Manual

Digital Camera/
Lens Kit/Body

Model No. **DMC-GX7C/DMC-GX7K**
DMC-GX7

LUMIX



Please read these instructions carefully before using this product,
and save this manual for future use.



More detailed instructions on the operation of this camera are contained in "Owner's Manual for advanced features (PDF format)" in the supplied CD-ROM. Install it on your PC to read it.



Register online at www.panasonic.com/register (U.S. customers only)

For USA and Puerto Rico assistance, please call: 1-800-211-PANA(7262) or,
contact us via the web at: <http://www.panasonic.com/contactinfo>



For Canadian assistance, please call: 1-800-99-LUMIX (1-800-995-8649).



VQT5A95

F0713HH0

Dear Customer,

Thank you for choosing Panasonic!

You have purchased one of the most sophisticated and reliable products on the market today. Used properly, we're sure it will bring you and your family years of enjoyment.

Please take time to fill in the information below. The serial number is on the tag located on the underside of your camera. Be sure to **retain this manual** as your convenient camera information source.

Date of Purchase	Dealer Phone No.
Dealer Purchased From	Model No.
Dealer Address	Serial No.

Please note that the actual controls and components, menu items, etc. of your Digital Camera may look somewhat different from those shown in the illustrations in this Owner's Manual.

Carefully observe copyright laws.

- Recording of pre-recorded tapes or discs or other published or broadcast material for purposes other than your own private use may infringe copyright laws. Even for the purpose of private use, recording of certain material may be restricted.



A lithium ion battery that is recyclable powers the product you have purchased. Please call 1-800-8-BATTERY for information on how to recycle this battery.

Information for Your Safety

WARNING:

To reduce the risk of fire, electric shock or product damage,

- **Do not expose this unit to rain, moisture, dripping or splashing.**
- **Use only the recommended accessories.**
- **Do not remove covers.**
- **Do not repair this unit by yourself. Refer servicing to qualified service personnel.**

The socket outlet shall be installed near the equipment and shall be easily accessible.

■ Product identification marking

Product	Location
Digital Camera	Bottom
Battery charger	Bottom

THE FOLLOWING APPLIES ONLY IN THE U.S.A.

FCC Note:

This equipment has been tested and found to comply with the limits for a Class B digital device, pursuant to Part 15 of the FCC Rules. These limits are designed to provide reasonable protection against harmful interference in a residential installation. This equipment generates, uses, and can radiate radio frequency energy and, if not installed and used in accordance with the instructions, may cause harmful interference to radio communications. However, there is no guarantee that interference will not occur in a particular installation. If this equipment does cause harmful interference to radio or television reception, which can be determined by turning the equipment off and on, the user is encouraged to try to correct the interference by one or more of the following measures:

- Reorient or relocate the receiving antenna.
- Increase the separation between the equipment and receiver.
- Connect the equipment into an outlet on a circuit different from that to which the receiver is connected.
- Consult the dealer or an experienced radio/TV technician for help.

FCC Caution: To assure continued compliance, follow the attached installation instructions and use only shielded interface cables with ferrite core when connecting to computer or peripheral devices.

Any changes or modifications not expressly approved by the party responsible for compliance could void the user's authority to operate this equipment.

Declaration of Conformity

Trade Name: Panasonic

Model No.: DMC-GX7

Responsible Party: Panasonic Corporation of North America

Two Riverfront Plaza, Newark, NJ 07102-5490

Support Contact Telephone No.: 1-800-211-PANA (7262)

This device complies with Part 15 of the FCC Rules. Operation is subject to the following two conditions: (1) This device may not cause harmful interference, and (2) this device must accept any interference received, including interference that may cause undesired operation.



THE FOLLOWING APPLIES ONLY IN THE U.S.A.

Certification and Compliance

See Camera for the certification and compliance mark specific to that device.

- 1 Select [Wi-Fi] in the [Setup] menu.**
- 2 Select [Wi-Fi Setup] in the [Wi-Fi] menu.**
- 3 Press ▲/▼ to select [Approved Regulations], and then press [MENU/SET].**

Contains FCC ID: VPYLBXN604

This transmitter must not be co-located or operated in conjunction with any other antenna or transmitter.

This equipment complies with FCC radiation exposure limits set forth for an uncontrolled environment and meets the FCC radio frequency (RF) Exposure Guidelines in Supplement C to OET65.

This equipment has very low levels of RF energy that are deemed to comply without testing of specific absorption ratio (SAR).

THE FOLLOWING APPLIES ONLY IN CANADA.

CAN ICES-3(B)/NMB-3(B)

This device complies with RSS-210 of the IC Rules.

Operation is subject to the following two conditions:

- (1) This device may not cause harmful interference,
- (2) This device must accept any interference received, including interference that may cause undesired operation of the device.

This equipment complies with IC radiation exposure limits set forth for an uncontrolled environment and meets RSS-102 of the IC radio frequency (RF) Exposure rules.

This equipment has very low levels of RF energy that are deemed to comply without testing of specific absorption ratio (SAR).

■ About the battery pack

CAUTION

Battery pack (Lithium ion battery pack)

- Use the specified unit to recharge the battery pack.
- Do not use the battery pack with equipment other than the specified unit.
- Do not get dirt, sand, liquids, or other foreign matter on the terminals.
- Do not touch the plug terminals (+ and -) with metal objects.
- Do not disassemble, remodel, heat or throw into fire.

If any electrolyte should come into contact with your hands or clothes, wash it off thoroughly with water.

If any electrolyte should come into contact with your eyes, never rub the eyes. Rinse eyes thoroughly with water, and then consult a doctor.

CAUTION

- Danger of explosion if battery is incorrectly replaced. Replace only with the type recommended by the manufacturer.
- When disposing the batteries, please contact your local authorities or dealer and ask for the correct method of disposal.

- Do not heat or expose to flame.
- Do not leave the battery(ies) in a car exposed to direct sunlight for a long period of time with doors and windows closed.

Warning

Risk of fire, explosion and burns. Do not disassemble, heat above 60 °C (140 °F) or incinerate.

■ About the battery charger

CAUTION!

To reduce the risk of fire, electric shock or product damage,

- **Do not install or place this unit in a bookcase, built-in cabinet or in another confined space. Ensure this unit is well ventilated.**

Battery charger

This battery charger operates on AC between 110 V and 240 V.

But

- In the U.S.A. and Canada, the battery charger must be connected to a 120 V AC power supply only.
- When connecting to an AC supply outside of the U.S.A. or Canada, use a plug adaptor to suit the AC outlet configuration.

■ Cautions for Use

- Do not use any other USB connection cables except the supplied one or a genuine Panasonic USB connection cable (DMW-USBC1: optional).
- Use a “High Speed HDMI mini cable” with the HDMI logo.
Cables that do not comply with the HDMI standards will not work.
“High Speed HDMI mini cable” (Type C–Type A plug, up to 3 m (9.8 feet) long)
- Always use a genuine Panasonic AV cable (DMW-AVC1: optional).
- Always use a genuine Panasonic shutter remote control (DMW-RSL1: optional).

Keep this unit as far away as possible from electromagnetic equipment (such as microwave ovens, TVs, video games etc.).

- If you use this unit on top of or near a TV, the pictures and/or sound on this unit may be disrupted by electromagnetic wave radiation.
- Do not use this unit near cell phones because doing so may result in noise adversely affecting the pictures and/or sound.
- Recorded data may be damaged, or pictures may be distorted, by strong magnetic fields created by speakers or large motors.
- Electromagnetic wave radiation generated by microprocessors may adversely affect this unit, disturbing the pictures and/or sound.
- If this unit is adversely affected by electromagnetic equipment and stops functioning properly, turn this unit off and remove the battery or disconnect AC adaptor (DMW-AC8PP: optional). Then reinsert the battery or reconnect AC adaptor and turn this unit on.

Do not use this unit near radio transmitters or high-voltage lines.

- If you record near radio transmitters or high-voltage lines, the recorded pictures and/or sound may be adversely affected.

-If you see this symbol-

Information on Disposal in other Countries outside the European Union

This symbol is only valid in the European Union.

If you wish to discard this product, please contact your local authorities or dealer and ask for the correct method of disposal.



Contents

Information for Your Safety.....	2
----------------------------------	---

Preparation

Reading the Owner's Manual (PDF format)	9
Care of the camera.....	10
Standard Accessories	11
Names and Functions of Components	13
Preparation	16
• Changing the Lens	16
• Attaching the Shoulder Strap	16
• Charging the Battery	17
• Inserting/Removing the Battery	18
• Inserting/Removing the Card (Optional)	18
• Formatting the card (initialization)	19
• Setting Date/Time (Clock Set).....	19
• Adjust the angle of the monitor/ viewfinder	20
• Using the Viewfinder	20
Setting the Menu	21
• Setting menu items	21
Calling frequently-used menus instantly (Quick Menu)	22

Basic

Assigning frequently used functions to the buttons (function buttons).....	23
Taking a Still picture	24
Recording Motion Picture	25
Selecting the Recording Mode	26
Switching the Information Displayed on the recording screen	27
Playing Back Pictures/ Motion Pictures	28
• Playing Back Pictures	28
• Playing Back Motion Pictures.....	29
• Changing the information displayed on the playback screen	30

Deleting Pictures	31
-------------------------	----

Recording

Taking Pictures using the Automatic Function (Intelligent Auto Mode)	32
• Taking a picture with a blurred background (Defocus Control)	33
• Recording images by changing the brightness or color tone.....	33
Taking Pictures with Your Favorite Settings (Program AE Mode).....	34
Taking Pictures by Specifying the Aperture/Shutter Speed	35
• Aperture-Priority AE Mode.....	35
• Shutter-Priority AE Mode	35
• Manual Exposure Mode.....	36
• Confirm the Effects of Aperture and Shutter Speed (Preview Mode)	37
Taking Pictures that match the Scene being recorded (Scene Guide Mode).....	37
Taking Pictures with different image effects (Creative Control Mode)	38
Registering your preferred settings (Custom Mode)	39
• Registering Personal Menu Settings (Registering custom settings).....	39
• Recording using registered custom set.....	39
Adjusting the Picture Quality by Adding an Effect [Photo Style].....	40
Adjusting Bright/Dark Portions [Highlight Shadow].....	42
Adjusting the White Balance	43
Setting the Picture Quality and Size	43
• Setting the aspect ratio of pictures.....	43
• Setting the number of pixels.....	44
• Setting the compression rate of pictures [Quality].....	44
Taking Pictures with Auto Focus	45
• About the focus mode (AFS/AFF/ AFC).....	46
Taking Pictures with Manual Focus	47

Fixing the Focus and the Exposure (AF/AE Lock)	48
Compensating the Exposure	49
Setting the Light Sensitivity	49
Select a Drive Mode	50
Taking Pictures using Burst Mode	51
Taking Pictures using Auto Bracket	53
Taking Pictures with the Self-timer	54
Optical Image Stabilizer	55
• Using the Optical Image Stabilizer function of a lens.....	56
• Using the Optical Image Stabilizer function of this unit.....	57
Taking Pictures with the Zoom	59
Taking pictures by using the flash	60
• Changing Flash Mode	60

Playback/Editing

Switching the Playback Method	61
• Displaying multiple screens (Multi Playback)	61
• Displaying Pictures by Recording Date (Calendar Playback).....	61
Using Playback Functions	62
• Creating Still Pictures from a Motion Picture.....	62
• Removing unnecessary parts [Clear Retouch].....	62

Wi-Fi/NFC

What you can do with the Wi-Fi® function	63
Controlling with a Smartphone/ Tablet	64
• Installing the smartphone/tablet app “Panasonic Image App”	64
• Connecting to a smartphone/tablet	65
• Taking pictures via a smartphone/tablet (remote recording)	67
• Saving images stored in the camera/ Sending images in the camera to an SNS	67

• Changing the connection method	69
--	----

About the supplied software

About the supplied software	73
--	----

Others

Monitor Display/Viewfinder Display	75
Menu list	81
• [Rec]	81
• [Motion Picture].....	83
• [Custom]	83
• [Setup]	86
• [Playback]	88
Specifications	89
Digital Camera Accessory System ...	95
Digital Camera Accessory Order Form (For USA and Puerto Rico Customers)	96
Limited Warranty (ONLY FOR U.S.A. AND PUERTO RICO)	97
Limited Warranty (ONLY FOR CANADA)	100
Panasonic Canada Inc. LUMIX Concierge for Camera Owners	102

Reading the Owner's Manual (PDF format)

More detailed instructions on the operation of this camera are contained in "Owner's Manual for advanced features (PDF format)" in the supplied CD-ROM. Install it on your PC to read it.

■ For Windows

- 1 Turn the PC on and insert the CD-ROM containing the Owner's Manual (supplied).
- 2 Select the desired language and then click [Owner's Manual] to install.
- 3 Double click the "Owner's Manual" shortcut icon on the desktop.

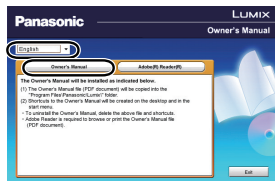

■ When the Owner's Manual (PDF format) will not open

You will need Adobe Acrobat Reader 5.0 or later or Adobe Reader 7.0 or later to browse or print the Owner's Manual (PDF format).

- You can download and install a version of Adobe Reader that you can use with your OS from the following Web Site.

<http://get.adobe.com/reader/otherversions>

■ To uninstall the Owner's Manual (PDF format)

Delete the PDF file from the "Program Files\Panasonic\Lumix\" folder.

■ For Mac

- 1 Turn the PC on and insert the CD-ROM containing the Owner's Manual (supplied).
- 2 Open the "Manual" folder in the CD-ROM and then copy the PDF file with the desired language inside the folder.
- 3 Double click the PDF file to open it.

Care of the camera

Do not subject to strong vibration, shock, or pressure.

- The lens, monitor, or external case may be damaged if used in the following conditions. It may also malfunction or image may not be recorded if you:
 - Drop or hit the camera.
 - Press hard on the lens or the monitor.

This camera is not dust/drip/water proof.

Avoid using the camera in places with a lot of dust, water, sand, etc.

- Liquid, sand and other foreign material may get into the space around the lens, buttons, etc. Be particularly careful since it may not just cause malfunctions, but it may also become irreparable.
 - Places with a lot of sand or dust.
 - Places where water can come into contact with this unit, such as when using it on a rainy day or at the beach.

Do not place your hands inside the mount of the digital camera body. Since the sensor unit is a precision apparatus, it may cause a malfunction or damage.

■ About Condensation (When the lens, the viewfinder or monitor is fogged up)

- Condensation occurs when the ambient temperature or humidity changes. Be careful of condensation since it causes lens, viewfinder and monitor stains, fungus and camera malfunction.
- If condensation occurs, turn the camera off and leave it for about 2 hours. The fog will disappear naturally when the temperature of the camera becomes close to the ambient temperature.

Standard Accessories

Check that all the accessories are supplied before using the camera.
Product numbers correct as of August 2013. These may be subject to change.

Digital Camera Body
(This is referred to as **camera body** in this owner's manual.)

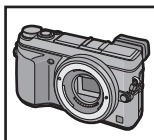

(○: Included, —: Not included)

	DMC-GX7C	DMC-GX7K	DMC-GX7
1 Interchangeable Lens*1	○*4	○*4	—
2 Lens Hood	—	○	—
3 Lens Cap	○*2	○*2	—
4 Lens Rear Cap	○*3	○*3	—
5 Body Cap	○*3	○*3	○*4

- 6 Battery Pack
(Indicated as **battery pack** or **battery** in the text)
Charge the battery before use.
- 7 Battery Charger
(Indicated as **battery charger** or **charger** in the text)
- 8 USB Connection Cable
- 9 CD-ROM
- Software:
Use it to install the software to your PC.
- 10 CD-ROM
- Owner's Manual for advanced features:
Use it to install to your PC.
- 11 Shoulder Strap
- 12 Hot shoe cover*4
- Ⓐ: Black
 - Ⓑ: Silver

*1 This is referred to as **lens** in this owner's manual.

*2 This is attached to the interchangeable lens at the time of purchase.

*3 These parts are supplied fitted together at the time of purchase.











*4 This is attached to the camera body at the time of purchase.







• SD Memory Card, SDHC Memory Card and SDXC Memory Card are indicated as **card** in the text.

• **The card is optional.**

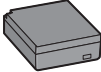
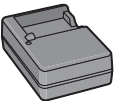
• Description in this owner's manual is based on the interchangeable lens (H-H020A).

• If any accessories are lost, customers in the USA and Puerto Rico should contact Panasonic's parts department at 1-800-833-9626 and customers in Canada should contact 1-800-99-LUMIX (1-800-995-8649) for further information about obtaining replacement parts.

	DMC-GX7C	DMC-GX7K	DMC-GX7
1	 H-H020A	 H-FS1442A	—
2	—	 VYC1113	—
3	 VYF3371	 VYF3510	—
4	 VFC4605	 VFC4605	—
5	 VKF4971	 VKF4971	 VKF4971



6	 DMW-BLG10PP	7	 DE-A99B	8	 K1HY08YY0034	9	 VFF1225
10	 VFF1225	11	 VFC5059	12	 Ⓐ: VKF5259/ Ⓑ: VKF5260		

Names and Functions of Components

■ Camera body

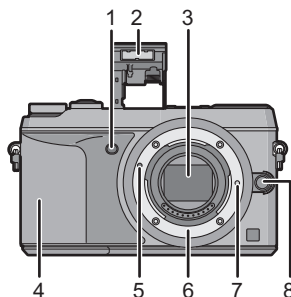
- 1 Self-timer indicator/
AF Assist Lamp
- 2 Flash
- 3 Sensor
- 4 NFC antenna [] (P66)
- 5 Lens fitting mark (P16)
- 6 Mount
- 7 Lens lock pin
- 8 Lens release button (P16)



- 9 Eye sensor (P20)
- 10 Eye Cup
- 11 Viewfinder (P20)
- 12 [LVF] button (P20)/[Fn4] button (P23)
- 13 Flash open lever (P60)
- 14 Focus mode lever (P45, 47)
- 15 [AF/AE LOCK] button (P48)
- 16 Rear dial
- 17 Touch screen/monitor (P15)
- 18 [Q.MENU] button (P22)/[Fn1] button (P23)
- 19 [] (Playback) button (P28)
- 20 [ / ] (Delete/Cancel) button (P31)/[Fn2] button (P23)
- 21 [MENU/SET] button (P21)
- 22 [Wi-Fi] button (P65)/[Fn3] button (P23)
- 23 Wi-Fi® connection lamp
- 24 Cursor buttons
 - ▲/ISO button (P49)
 - ▶/WB (White Balance) (P43)
 - ◀/AF Mode button (P45)
 - ▼/[Drive Mode] button (P50)

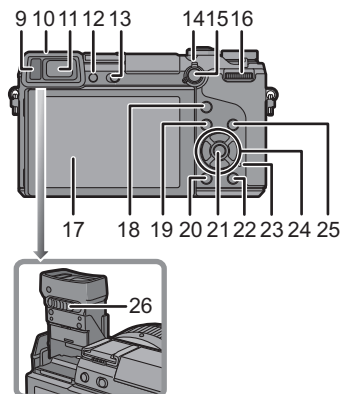

The following settings can be made with the [Drive Mode] button.

Single/Burst/Auto bracket/Self-timer

- 25 [DISP.] button (P27, 30)
- 26 Diopter adjustment lever (P20)

27 Stereo microphone

- Be careful not to cover the microphone with your finger. Doing so may make sound difficult to record.

28 Hot shoe (Hot shoe cover)

- Keep the Hot Shoe Cover out of reach of children to prevent swallowing.

29 Focus distance reference mark

30 Shutter button (P24)

31 Front dial

32 Mode dial (P26)

33 Motion picture button (P25)

34 Status indicator (P19)

35 Camera ON/OFF switch (P19)

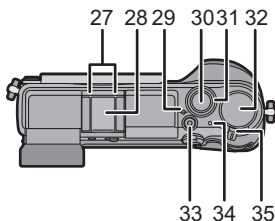

36 Tripod mount

- A tripod with a screw length of 5.5 mm (0.22 inch) or more may damage this unit if attached.

37 DC coupler cover

- When using an AC adaptor, ensure that the Panasonic DC coupler (DMW-DCC11: optional) and AC adaptor (DMW-AC8PP: optional) are used.
- Always use a genuine Panasonic AC adaptor (DMW-AC8PP: optional).
- It is recommended to use a fully charged battery or AC adaptor when recording motion pictures.
- If while recording motion pictures using the AC adaptor and the power supply is cut off due to a power outage or if the AC adaptor is disconnected etc., the motion picture will not be recorded.

38 Release lever

39 Card/Battery door (P18)

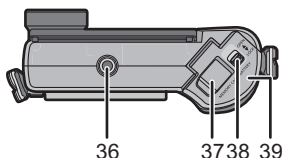

40 Shoulder strap eyelet (P16)

- Be sure to attach the shoulder strap when using the camera to ensure that you will not drop it.

41 [AV OUT/DIGITAL] socket

42 [HDMI] socket

43 [REMOTE] socket

44 Speaker

- Be careful not to cover the speaker with your finger. Doing so may make sound difficult to hear.

45 Terminal cover

- Open the monitor before opening the terminal cover.

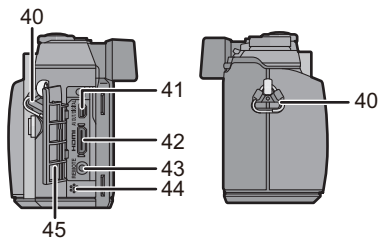

■ Lens

H-H020A

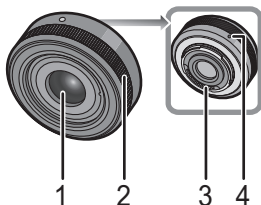

- 1 Lens surface
- 2 Focus ring (P47)
- 3 Contact point
- 4 Lens fitting mark

H-FS1442A

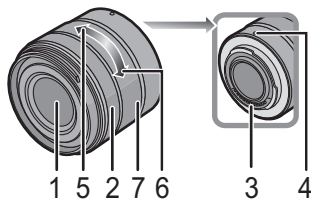

- 5 Tele
- 6 Wide
- 7 Zoom ring

Touch screen

Touch panel of this unit is capacitive. Touch the panel directly with your bare finger.

■ Touch

To touch and release the touch screen.

Use for selecting items or icons.

- When selecting features using the touch screen, be sure to touch the center of the desired icon.

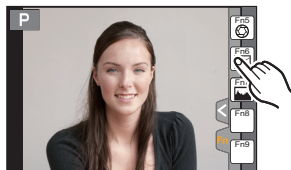

■ Drag

A movement without releasing the touch screen.

This is used to move the AF area, operate the slide bar, etc.

This can also be used to move to the next image during playback, etc.

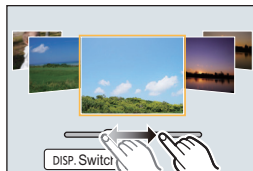

■ Pinch (enlarge/reduce)

Pinch the touch panel apart (enlarge) or together (reduce) with two fingers.

Use to enlarge/reduce the played back images or AF area.

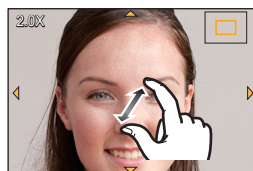

Preparation

- Check that the camera is turned off.

Changing the Lens

- Change lenses where there is not a lot of dirt or dust.

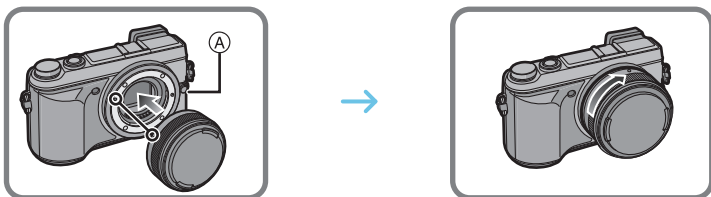

- Do not press the lens release button (A) when you attach a lens.

■ Detaching the lens

- 1 Attach the lens cap.
- 2 While pressing on the lens release button (A), rotate the lens toward the arrow until it stops and then remove.

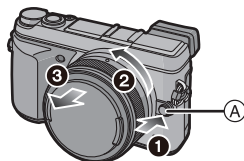

Attaching the Shoulder Strap

- We recommend attaching the shoulder strap when using the camera to prevent it from dropping.

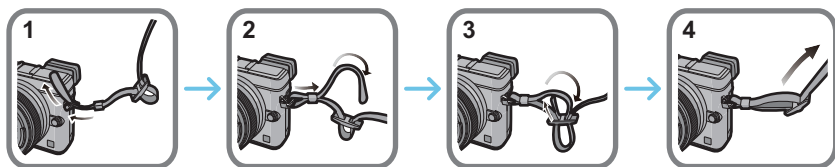

- Perform steps 1 to 4 and then attach the other side of the shoulder strap.

- Use the shoulder strap around your shoulder.
 - Do not wrap the strap around your neck.
 - It may result in injury or accident.
- Do not leave the shoulder strap where an infant can reach it.
 - It may result in an accident by mistakenly wrapping around the neck.

Charging the Battery

The battery that can be used with this unit is DMW-BLG10PP.

- 1 Attach the battery paying attention to the direction of the battery.
- 2 Connect the charger to the electrical outlet.
 - The [CHARGE] indicator (A) lights up and charging begins.

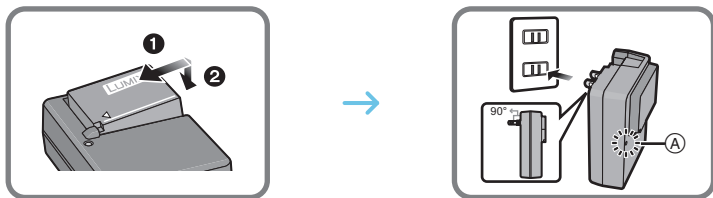

■ About the [CHARGE] indicator

The [CHARGE] indicator turns on:

The [CHARGE] indicator is turned on during charging.

The [CHARGE] indicator turns off:

The [CHARGE] indicator will turn off once the charging has completed without any problem. (Disconnect the charger from the electrical socket and detach the battery after charging is completed.)

■ Charging time

Charging time	Approx. 190 min
<ul style="list-style-type: none"> • The indicated charging time is for when the battery has been discharged completely. The charging time may vary depending on how the battery has been used. The charging time for the battery in hot/cold environments or a battery that has not been used for a long time may be longer than normal. 	

Inserting/Removing the Battery

- Always use genuine Panasonic batteries (DMW-BLG10PP).
- If you use other batteries, we cannot guarantee the quality of this product.

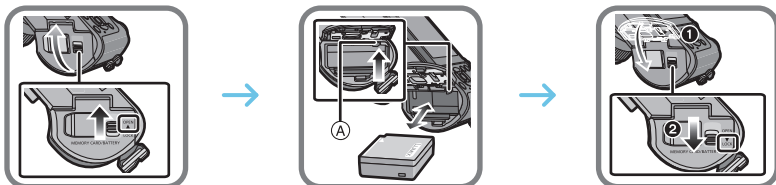

- Being careful about the battery orientation, insert all the way until you hear a locking sound and then check that it is locked by lever (A).
Pull the lever (A) in the direction of the arrow to remove the battery.

Inserting/Removing the Card (Optional)

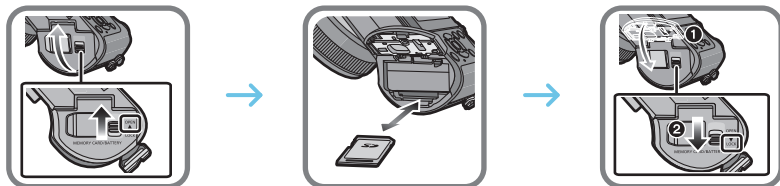

- Push it securely all the way until you hear a “click” while being careful about the direction in which you insert it.
To remove the card, push the card until it clicks, then pull the card out upright.

■ About cards that can be used with this unit

SD Memory Card (8 MB to 2 GB)
SDHC Memory Card (4 GB to 32 GB)
SDXC Memory Card (48 GB, 64 GB)

■ About the motion picture recording and SD speed class

Confirm the SD Speed Class (the speed standard regarding continuous writing) on a card label etc. when you record a motion picture. Use a card with SD Speed Class with “Class 4” or more for [AVCHD]/[MP4] motion picture recording.

e.g.:

CLASS **4** **4**

- Please confirm the latest information on the following website.

<http://panasonic.jp/support/global/cs/dsc/>

(This Site is English only.)

- Keep the Memory Card out of reach of children to prevent swallowing.

Formatting the card (initialization)

Format the card before recording a picture with this unit.

Since data cannot be recovered after formatting, make sure to back up necessary data in advance.

Select **[Format]** in the **[Setup]** menu. (P21)

- Confirmation screen is displayed. It is executed when **[Yes]** is selected.

Setting Date/Time (Clock Set)

- The clock is not set when the camera is shipped.

1 Turn the camera on.

- The status indicator **1** lights when you turn this unit on.

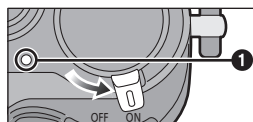

2 Press **[MENU/SET]**.

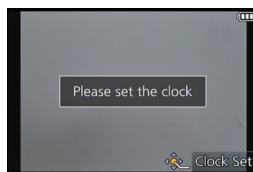

3 Press **◀/▶** to select the items (year, month, day, hour, minute), and press **▲/▼** to set.

4 Press **[MENU/SET]** to set.

5 Press **[MENU/SET]** in the confirmation screen.

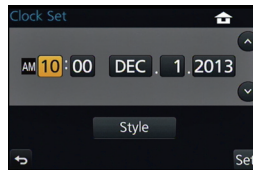

Adjust the angle of the monitor/viewfinder

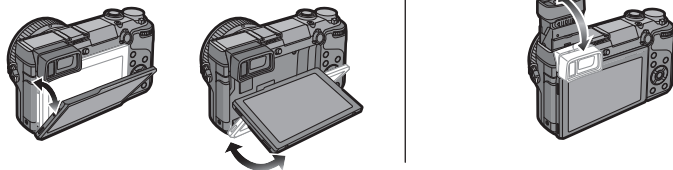

Adjust the angle of the monitor/viewfinder.

- Be careful not to catch your finger, etc. in the monitor/viewfinder.
- When adjusting the angle of the monitor/viewfinder, be careful not to apply too much force, as this may cause damage or malfunction.
- When not using this unit, close the monitor/viewfinder completely back to the original position.

Using the Viewfinder

■ Using the eye sensor to switch between the Monitor and Viewfinder

When [LVF/Monitor Auto] of [Eye Sensor] in the [Custom] menu is set to [ON] and your eye or an object is brought close to the viewfinder, the display automatically switches to the viewfinder display.

- Ⓐ Eye sensor
- Ⓑ [LVF]/[Fn4] button

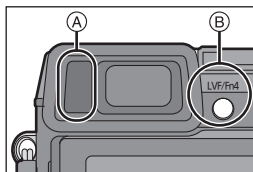

■ Switching the Monitor/Viewfinder manually

Press [LVF].

The Viewfinder lights only when your eye or an object is moved closer to it.

[LVF]/[Fn4] button can be used in two ways, as [LVF] or as [Fn4] (function 4). At the time of purchase, it is initially set to [LVF/Monitor Switch].

- Refer to P23 for details about the function button.

■ Diopter adjustment

Slide the diopter adjustment lever so that the characters displayed in the viewfinder can be seen clearly.

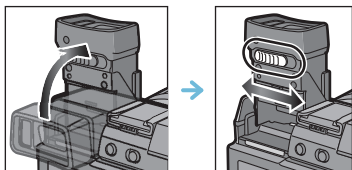

Setting the Menu

Setting menu items

1 Press [MENU/SET].

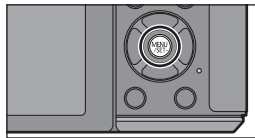

Menu	Description of settings
[Rec]	This menu lets you set the aspect ratio, number of pixels and other aspects of the pictures you are recording.
[Motion Picture]	This menu lets you set the [Rec Format], [Rec Quality], and other aspects for motion picture recording.
[Custom]	Operation of the unit, such as displaying of the screen and button operations, can be set up according to your preferences. Also, it is possible to register the modified settings.
[Setup]	This menu lets you perform the clock settings, select the operating beep tone settings and set other settings which make it easier for you to operate the camera. You can also configure the settings of Wi-Fi related functions.
[Playback]	This menu lets you set the Protection, Cropping or Print Settings, etc. of recorded pictures.

2 Press ▲/▼ of the cursor button to select the menu item and press [MENU/SET].

3 Press ▲/▼ of the cursor button to select the setting and press [MENU/SET].

- Depending on the menu item, its setting may not appear or it may be displayed in a different way.



■ Close the menu

Press [⏪/⏩] or press the shutter button halfway.

■ Switching to other menus

e.g.: Switching to the [Setup] menu from [Rec] menu.

- 1 Press **◀**.
- 2 Press **▲/▼** to select [**⌂**] or another of the menu toggle icons **(A)**.
- 3 Press **[MENU/SET]**.



• You can also select the menu toggle icons by rotating the front dial.

Calling frequently-used menus instantly (Quick Menu)

By using the Quick Menu, some of the menu settings can be easily found.

- The features that can be adjusted using Quick Menu are determined by the mode or a display style the camera is in.

[Q.MENU]/[Fn1] button can be used in two ways, as [Q.MENU] or as [Fn1] (function 1). At the time of purchase, it is initially set to [Q.MENU].

- Refer to P23 for details about the function button.

- 1 Press **[Q.MENU]** to display the Quick Menu.

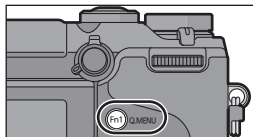

- 2 Rotate the rear dial to select the menu item, then press the rear dial.

- 3 Rotate the rear dial to select the setting.

- 4 Press **[Q.MENU]** to exit the menu once the setting is complete.

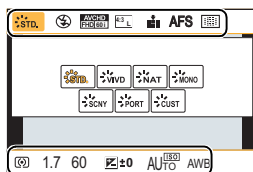

- You can close the menu by pressing the shutter button halfway.

Assigning frequently used functions to the buttons (function buttons)

You can assign frequently-used functions to particular buttons or icons.

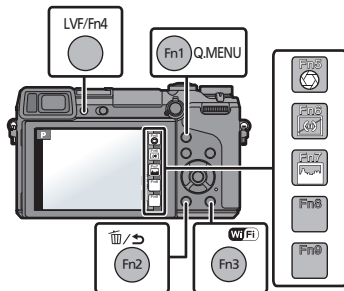

1 Select the menu.

MENU → [Custom] → [Fn Button Set]

- 2 Press ▲/▼ to select [Setting in REC mode] or [Setting in PLAY mode] and then press [MENU/SET].
- 3 Press ▲/▼ to select the function button you want to assign a function to and then press [MENU/SET].
- 4 Press ▲/▼ to select the function you want to assign and then press [MENU/SET].

- Some functions cannot be assigned depending on the function button.

Taking a Still picture

- Set the drive mode to [] (single) by pressing ▼ ([]).

1 Select the Recording Mode. (P26)

2 Press the shutter button halfway to focus.

- Ⓐ Aperture value
- Ⓑ Shutter speed

- Aperture value and shutter speed are displayed. (It will flash in red if the correct exposure is not achieved, except when set to flash.)
- **When the image is correctly focused, the picture will be taken, since the [Focus/Release Priority] is set initially to [FOCUS].**

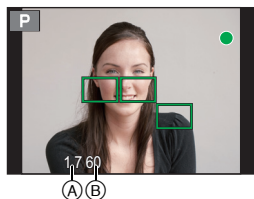

3 Press the shutter button fully (push it in further), and take the picture.



Recording Motion Picture

This camera can record full high definition motion pictures compatible with the AVCHD format or motion pictures recorded in MP4.

Audio will be recorded in stereo.

Item	Format
[AVCHD]	This data format is suitable for when playing back on a high-definition TV, etc.
[MP4]	This data format is suitable for when playing back on a PC, etc.

1 Start recording by pressing the motion picture button.

- (A) Elapsed recording time
- (B) Available recording time

- The recording state indicator (red ©) will flash while recording motion pictures.
- If approximately 1 minute elapses without an operation being performed, part of the display will disappear. Press [DISP.] or touch the monitor to make the display reappear.
- Release the motion picture button right after you press it.

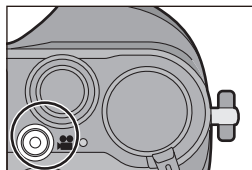

2 Stop the recording by pressing the motion picture button again.

- Maximum time to record motion pictures continuously with [MP4] is 29 minutes 59 seconds or up to 4 GB. (For [FHD/60p], [FHD/30p] in [MP4] format, the file size is large and so the recordable time will drop below 29 minutes 59 seconds.)
- Still picture recording is also possible during the motion picture recording by fully pressing the shutter button.

Selecting the Recording Mode

Select the mode by rotating the mode dial.

- Rotate the mode dial slowly to select the desired mode (A).

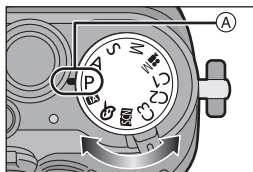

iA Intelligent Auto Mode (P32)

The subjects are recorded using settings automatically selected by the camera.

iA+ Intelligent Auto Plus Mode (P32)

Allows you to adjust the brightness and color hue when in Intelligent Auto Mode.

P Program AE Mode (P34)

Records at the aperture value and shutter speed set by the camera.

A Aperture-Priority AE Mode (P35)

The shutter speed is automatically determined by the aperture value you set.

S Shutter-Priority AE Mode (P35)

The aperture value is automatically determined by the shutter speed you set.

M Manual Exposure Mode (P36)

The exposure is adjusted by the aperture value and the shutter speed which are manually adjusted.

M Creative Video Mode

Records motion pictures with a manually set aperture value and shutter speed.

* You cannot take still pictures.

C1 C2 C3 Custom Mode (P39)

Use this mode to take pictures with previously registered settings.

SCN Scene Guide Mode (P37)

This mode allows you to take pictures that match the scene being recorded.

🌀 Creative Control Mode (P38)

Record while checking the image effect.

Switching the Information Displayed on the recording screen

Press [DISP.] to change.

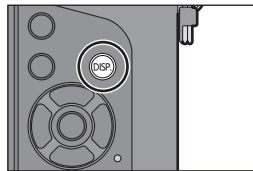

- Screen will switch as follows:
(Example of monitor display)

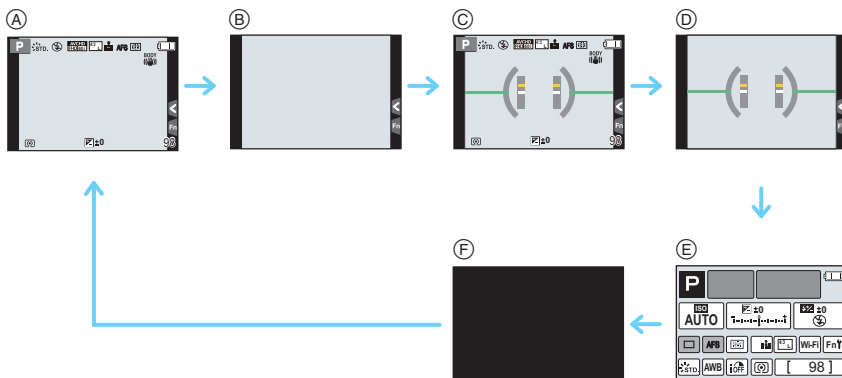

- (A) With information
- (B) Without information
- (C) With information (tilt sensor display)
- (D) Without information (tilt sensor display)
- (E) On-monitor recording information*
- (F) Turned off

* It is displayed when the [Monitor Info. Disp.] of the [Custom] menu is set to [ON].
Settings can be adjusted directly by touching each of the items displayed on the screen.

- If approximately 1 minute elapses without an operation being performed, part of the display will disappear. Press [DISP.] or touch the monitor to make the display reappear.

Playing Back Pictures/Motion Pictures

Playing Back Pictures

1 Press **[▶]**.

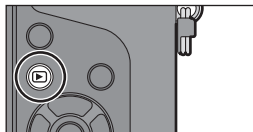

2 Press **◀/▶**.

- ◀: Play back the previous picture
- ▶: Play back the next picture



Using the Playback Zoom

Rotate the rear dial right.

1× → 2× → 4× → 8× → 16×

- When you change the magnification, the zoom position indication (A) appears for about 1 second.
- You can move the enlarged part by pressing ▲/▼/◀/▶ of the cursor button or dragging the screen. (P15)
- You can also enlarge (2×) the image by double-touching the part you want to enlarge. If you double-touch the enlarged image, the magnification is reset to 1×.

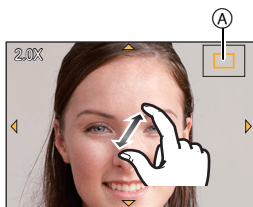

Playing Back Motion Pictures

This unit was designed to play motion pictures using the AVCHD, MP4 and QuickTime Motion JPEG formats.









In Playback Mode, select a picture with the motion picture icon ([]), and then press **▲ to play back.**

(A) Motion picture recording time

- After playback starts, the elapsed playback time is displayed on the screen.



■ Operations during Motion Picture Playback

▲		Play/Pause	▼		Stop
◀		Fast rewind	▶		Fast forward
		Frame-by-frame rewind (while pausing)			Frame-by-frame forward (while pausing)
Rear dial (left)		Reduce volume level	Rear dial (right)		Increase volume level

Changing the information displayed on the playback screen

Press [DISP.] to switch the monitor screen.

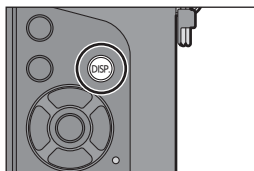

• Screen will switch as follows:

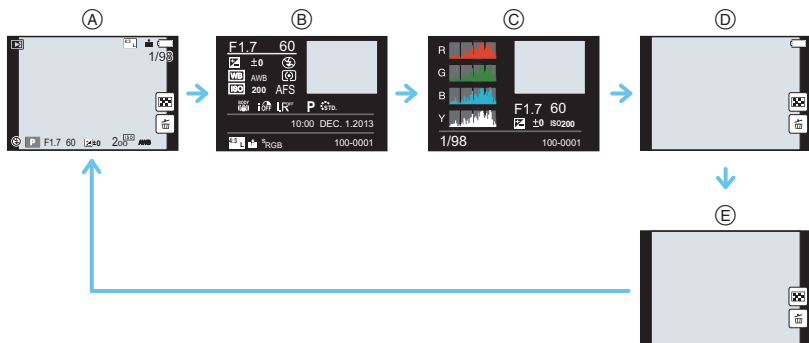

- (A) With information^{*1}
- (B) Detailed information display
- (C) Histogram display
- (D) Without information (Highlight display)^{*1,2}
- (E) Without information

*1 If approximately 1 minute elapses without an operation being performed, part of the display will disappear. Press [DISP.] or touch the monitor to make the display reappear.

*2 This is displayed if [Highlight] in the [Custom] menu is set to [ON].

Deleting Pictures

Once deleted, pictures cannot be recovered.

To delete a single picture

1 In Playback Mode, select the picture to delete and then press [🗑️/↵].

- The same operation can be performed by touching [🗑️].

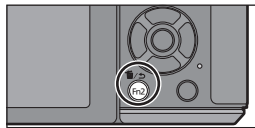

2 Press ▲ to select [Delete Single] and then press [MENU/SET].

- Confirmation screen is displayed.
Picture is deleted by selecting [Yes].

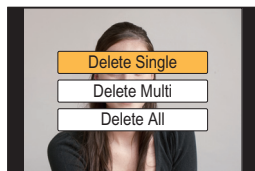

To delete multiple pictures (up to 100*) or all the pictures

- * Picture groups are treated as a single picture. (All the pictures in the selected picture group will be deleted.)

1 In Playback Mode, press [🗑️/↵].

2 Press ▲/▼ to select [Delete Multi] or [Delete All] and then press [MENU/SET].

- [Delete All] → Confirmation screen is displayed.
Pictures are deleted by selecting [Yes].
- It is possible to delete all pictures except the ones set as favorite when [All Delete Except Favorite] is selected with the [Delete All] set.

3 (When [Delete Multi] is selected) Press ▲/▼/◀/▶ to select the picture, and then press [MENU/SET] to set. (Repeat this step.)

- [🗑️] appears on the selected pictures. If [MENU/SET] is pressed again, the setting is canceled.



4 (When [Delete Multi] is selected) Press ◀ to select [OK], and then press [MENU/SET] to execute.

- Confirmation screen is displayed.
Pictures are deleted by selecting [Yes].

Taking Pictures using the Automatic Function

(Intelligent Auto Mode)

Recording Mode:  

When you wish to leave settings to the camera and record without thinking about them, use Intelligent Auto Plus Mode or Intelligent Auto Mode, which makes optimal settings for the subject and scene.

About Intelligent Auto Plus Mode and Intelligent Auto Mode

- Functions that can be set differ between Intelligent Auto Plus Mode and Intelligent Auto Mode.
(○: possible, —: not possible)

	Intelligent Auto Plus Mode	Intelligent Auto Mode
Setting the brightness	○	—
Setting the color tone	○	—
Defocus Control	○	○

1 Set the mode dial to .

- The camera will switch to either the most recently used of Intelligent Auto Mode or Intelligent Auto Plus Mode.
At the time of purchase, the mode is set to Intelligent Auto Plus Mode.

2 Align the screen with the subject.

- When the camera identifies the optimum scene, the icon of the scene concerned is displayed in blue for 2 seconds, after which its color changes to the usual red.
- When the subject is touched, AF Tracking function works.
It is also possible by pressing the cursor button towards , and then pressing the shutter button halfway.



Switching between Intelligent Auto Plus Mode and Intelligent Auto Mode

1 Press [MENU/SET].

- Press , and press / to select  or .

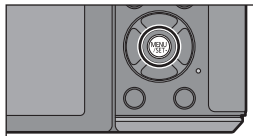

2 Press to select or and then press [MENU/SET].

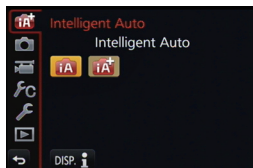

Taking a picture with a blurred background (Defocus Control)

Recording Mode:  

You can easily set the blurriness of the background while checking the screen.

1 Press the rear dial to display the setting screen.

- Each time the rear dial is pressed in Intelligent Auto Plus Mode, the camera switches between brightness setting operation, Defocus Control operation, and normal operation.
- Each time the rear dial is pressed in Intelligent Auto Mode, the camera switches between Defocus Control operation and normal operation.

2 Set the blurriness by rotating the rear dial.

3 Record pictures or motion pictures.

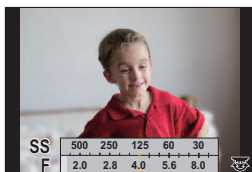

Recording images by changing the brightness or color tone

Recording Mode: 

This mode enables you to change the brightness and color tone to your preferred settings from the ones set by the camera.

Setting brightness

1 Press the rear dial to display the setting screen.

- Each press of the rear dial switches among brightness setting, Defocus Control and end operation.

2 Rotate the rear dial to adjust brightness.



Setting color

1 Press to display the setting screen.

2 Rotate the rear dial to adjust color.

- This will adjust the color of the image from a reddish color to a bluish color.
- Press [MENU/SET] to return to the recording screen.

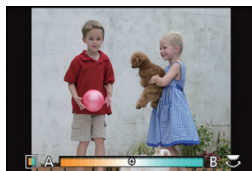

Taking Pictures with Your Favorite Settings

(Program AE Mode)

Recording Mode: **P**

The camera automatically sets the shutter speed and the aperture value according to the brightness of the subject.

You can take pictures with greater freedom by changing various settings in the [Rec] menu.

1 Set the mode dial to [P].

2 Press the shutter button halfway and display the aperture value and shutter speed value on the screen.

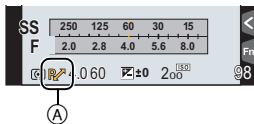

3 While the values are displayed (about 10 seconds), perform Program Shift by rotating the rear dial or front dial.

- The Program Shift indication (A) appears on the screen.
- To cancel Program Shift, turn off this unit or rotate the front/rear dial until the Program Shift indication disappears.

Program Shift

In Program AE Mode, you can change the preset aperture value and shutter speed without changing the exposure. This is called Program Shift.

You can make the background more blurred by decreasing the aperture value or record a moving subject more dynamically by slowing the shutter speed when taking a picture in Program AE Mode.

Taking Pictures by Specifying the Aperture/ Shutter Speed

Recording Mode: **A** **S** **M**

Aperture-Priority AE Mode

Set the aperture value to a higher number when you want a sharp focus background. Set the aperture value to a lower number when you want a soft focus background.

- 1 Set the mode dial to [A].
- 2 Set the aperture value by rotating the rear dial or the front dial.

- (A) Aperture value
- (B) Exposure meter

- The effects of the set aperture value will not be visible on the recording screen. To check on the recording screen, please use [Preview]. (P37)

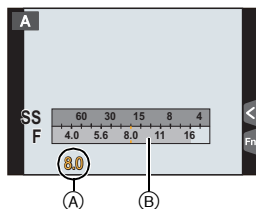

Shutter-Priority AE Mode

When you want to take a sharp picture of a fast moving subject, set with a faster shutter speed. When you want to create a trail effect, set to a slower shutter speed.

- 1 Set the mode dial to [S].
- 2 Set the shutter speed by rotating the rear dial or the front dial.

- (A) Shutter speed
- (B) Exposure meter

- The effects of the set shutter speed will not be visible on the recording screen. To check on the recording screen, please use [Preview]. (P37)

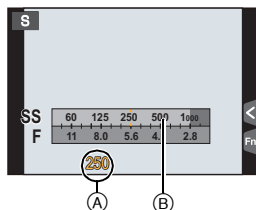

Manual Exposure Mode

Determine the exposure by manually setting the aperture value and the shutter speed. The Manual Exposure Assistance appears on the lower portion of the screen to indicate the exposure.

- 1 Set the mode dial to [M].
- 2 Rotate the rear dial to set the shutter speed, and rotate the front dial to set the aperture value.

- (A) Exposure meter
- (B) Aperture value
- (C) Shutter speed
- (D) Manual Exposure Assistance

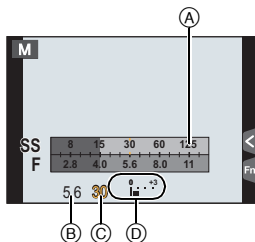

Manual Exposure Assistance

	The exposure is adequate.
	Set to faster shutter speed or larger aperture value.
	Set to slower shutter speed or smaller aperture value.

About [B] (Bulb)

If you set the shutter speed to [B], the shutter stays open while the shutter button is pressed fully (up to about 120 seconds).

The shutter closes if you release the shutter button.

Use this when you want to keep the shutter open for a long time to take pictures of fireworks, a night scene etc.

- When you take pictures with the shutter speed set to [B], noise may become visible. To avoid picture noise, we recommend setting [Long Shtr NR] in the [Rec] menu to [ON] before taking pictures.
- The Manual Exposure Assistance does not appear.
- This cannot be used when [Electronic Shutter] is set to [ON].
- It can only be used with Manual Exposure Mode.

Constant preview

In Manual Exposure Mode, when [Constant Preview] in the [Custom] menu is [ON], you will be able to confirm the effects of aperture and shutter speed on the screen.

- Close the flash.
- It can only be used with Manual Exposure Mode.

Confirm the Effects of Aperture and Shutter Speed (Preview Mode)

Applicable modes: **[Fn]** **[Fn]** **P** **A** **S** **M** **[M]** **C1** **C2** **C3** **[SCN]** **[Fn]**

- 1 Set a function button to [Preview]. (P23)
 - The following step is an example in which [Preview] is assigned to [Fn5].
- 2 Touch **[Fn]**.
- 3 Switch the confirmation screen by touching **[Fn5]**.
 - The screen switches each time [Fn5] is touched.

Normal recording screen → Effects of Aperture → Effects of Shutter Speed



Taking Pictures that match the Scene being recorded (Scene Guide Mode)

Recording Mode: **[SCN]**

If you select a scene to suit the subject and recording conditions with reference to the example images, the camera will set optimal exposure, color, and focus, allowing you to record in a manner appropriate to the scene.

- 1 Set the mode dial to **[SCN]**.
- 2 Press **◀/▶** to select the scene.
 - The scene can also be selected by dragging an example image or the slide bar.
- 3 Press **[MENU/SET]** to set.



Switching the scene selection screen display

Press **[DISP.]** to switch the monitor screen.

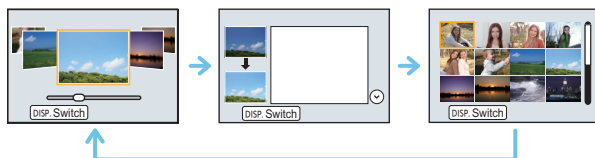



Taking Pictures with different image effects

(Creative Control Mode)

Recording Mode: 

This mode records with additional image effects. You can set the effects to add by selecting example images and checking them on the screen.

- 1 Set the mode dial to .
- 2 Press $\blacktriangle/\blacktriangledown$ to select the image effects (filters).

- The image effect of the selected example image will be applied in a preview display .
- You can also select the image effects (filters) by touching the example images.

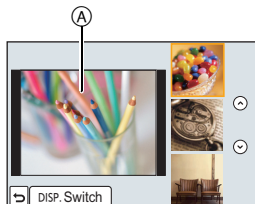

- 3 Press [MENU/SET] to set.

■ Switching the image effect (filter) selection screen display

Press [DISP.] to switch the monitor screen.

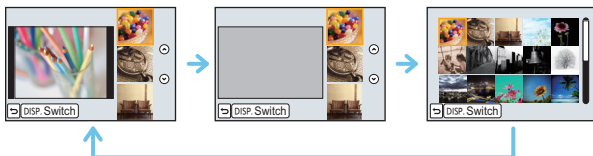

Registering your preferred settings (Custom Mode)

Recording Mode: **C1** **C2** **C3**

You can register the current camera settings as custom settings. If you then record in Custom Mode, you can use the registered settings.

- Initial setting of the Program AE Mode is registered as the custom settings initially.

Registering Personal Menu Settings (Registering custom settings)

To allow recording using the same settings, up to 5 sets of current camera settings can be registered using [Cust.Set Mem.]. (C1, C2, C3-1, C3-2, C3-3)

Preparations: Set in advance the Recording Mode you wish to save and select the desired menu settings on the camera.

1 Select the menu.

MENU → [Custom] → [Cust.Set Mem.]

2 Press ▲/▼ to select the custom set to register and then press [MENU/SET].

- Confirmation screen is displayed. It is executed when [Yes] is selected. Exit the menu after it is executed.

Recording using registered custom set

You can easily call up the settings you have registered using [Cust.Set Mem.].

Set the mode dial to [C1] or [C2].

- The custom set registered for [C1] or [C2] is called up.

1 Set the mode dial to [C3].

- The custom set registered for [C3-1], [C3-2] or [C3-3] is called up. The most recently used custom set is called up.
- To change a custom set
→ To steps **2** and **3**.

- 2 Press [MENU/SET] to display the menu.
- 3 Press ◀/▶ to select the custom setting you want to use, and then press [MENU/SET].

■ Changing the settings







Registered contents do not change when the menu setting is changed temporarily with the mode dial set to C1, C2 or C3. To change the registered settings, overwrite the registered content using [Cust.Set Mem.] on the custom settings menu.

Adjusting the Picture Quality by Adding an Effect [Photo Style]

Applicable modes:   P A S M  C1 C2 C3  

6 effects can be selected to match the image you wish to record. It is possible to adjust the items such as color or picture quality of the effect to your desire.

MENU → [Rec] → [Photo Style]

Settings	Description of settings
 [Standard]	This is the standard setting.
 [Vivid]*	Brilliant effect with high saturation and contrast.
 [Natural]*	Soft effect with low saturation.
 [Monochrome]	Monochrome effect with no color shades.
 [Scenery]*	An effect appropriate for sceneries with vivid blue skies and greens.
 [Portrait]*	An effect appropriate for portraits with a healthy and beautiful skin tone.
 [Custom]*	Use the setting registered in advance.

* This is disabled when Intelligent Auto Plus () Mode is selected.

■ Adjusting the picture quality

• Picture quality cannot be adjusted in the Intelligent Auto Plus Mode.

- 1 Press ◀/▶ to select the type of Photo Style.
 - In Scene Guide Mode, you cannot select the photo style.
- 2 Press ▲/▼ to select the items, and then press ◀/▶ to adjust.

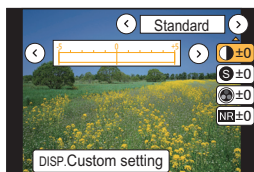

Item		Effect
☉ [Contrast]	[+]	Increases the difference between the brightness and the darkness in the picture.
	[-]	Decreases the difference between the brightness and the darkness in the picture.
Ⓢ [Sharpness]	[+]	The picture is sharply defined.
	[-]	The picture is softly focused.
⊗ [Saturation]	[+]	The colors in the picture become vivid.
	[-]	The colors in the picture become natural.
NR [Noise Reduction]	[+]	The noise reduction effect is enhanced. Picture resolution may deteriorate slightly.
	[-]	The noise reduction effect is reduced. You can obtain pictures with higher resolution.
⊗ [Filter Effect]*	[Yellow]	Enhances the contrast of an subject. (Effect: Weak) The blue sky can be recorded clearly.
	[Orange]	Enhances the contrast of an subject. (Effect: Medium) The blue sky can be recorded in darker blue.
	[Red]	Enhances the contrast of an subject. (Effect: Strong) The blue sky can be recorded in much darker blue.
	[Green]	The skin and lips of people and green leaves appear in natural tones. Green leaves appear brighter and more enhanced.
	[Off]	-

* Displayed only when [Monochrome] is selected.

- Registered settings are memorized even if the camera is turned off.
- If you adjust the picture quality, [+] is displayed beside the Photo Style icon on the screen.
- Color can be changed by [Saturation] when [Monochrome] is selected.

- 3 Press [MENU/SET].

■ Registering settings to [Custom]

Adjust the picture quality following step 2 of “Adjusting the picture quality”, and then press [DISP].

• Confirmation screen is displayed. It is executed when [Yes] is selected.

Adjusting Bright/Dark Portions [Highlight Shadow]

Applicable modes: **P** **A** **S** **M** **C1** **C2** **C3**

You can adjust the brightness of bright and dark portions on an image while checking the brightness on the screen.

1 Select the menu.

MENU → **[Rec]** → **[Highlight Shadow]**

2 Press **◀/▶** to select the item.

Item	Description of settings
<input checked="" type="checkbox"/> (Standard)	A state with no adjustments is set.
<input checked="" type="checkbox"/> (Raise the contrast)	Bright areas are brightened, and dark areas are darkened.
<input checked="" type="checkbox"/> (Lower the contrast)	Bright areas are darkened, and dark areas are brightened.
<input checked="" type="checkbox"/> (Brighten dark areas)	Dark areas are brightened.
/ / (Custom)	Registered custom settings can be applied.

3 Rotate the front/rear dial to adjust the brightness of bright/dark portions.

(A) Bright portion

(B) Dark portion

(C) Preview display

- The rear dial is for adjusting dark areas, and the front dial is for adjusting bright areas.
- To register a preferred setting, press **▲**, and select the destination where the custom setting will be registered ([Custom1] () / [Custom2] () / [Custom3] ()).
- Adjustments can also be made by dragging the graph.

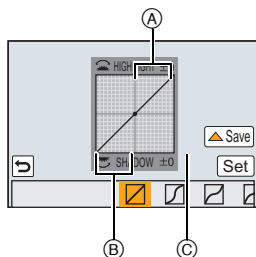

4 Press **[MENU/SET]**.

- The screen display can be switched by pressing **[DISP.]** on the brightness adjustment screen.
- Settings registered to / / will be stored even after this unit is turned off.
- Turning off this unit will return the setting adjusted with / / back to the default setting.

Adjusting the White Balance

Applicable modes: **P** **A** **S** **M** **C1** **C2** **C3**

In sunlight, under incandescent lights or in other such conditions where the color of white takes on a reddish or bluish tinge, this item adjusts to the color of white which is closest to what is seen by the eye in accordance with the light source.

1 Press **▶** (**WB**).

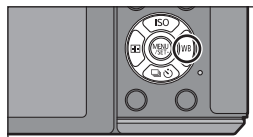

2 Select the White Balance by rotating the rear dial.



3 Press the rear dial to set.

Setting the Picture Quality and Size

Setting the aspect ratio of pictures

Applicable modes: **P** **A** **S** **M** **C1** **C2** **C3**

This allows you to select the aspect ratio of the pictures to suit printing or the playback method.

MENU → **[Rec]** → **[Aspect Ratio]**

Settings	Description of settings
[4:3]	[Aspect Ratio] of a 4:3 TV
[3:2]	[Aspect Ratio] of a 35 mm film camera
[16:9]	[Aspect Ratio] of a high-definition TV, etc.
[1:1]	Square aspect ratio

• The ends of the recorded pictures may be cut at printing so check before printing.

Setting the number of pixels

Applicable modes:

Set the number of pixels. The higher the numbers of pixels, the finer the detail of the pictures will appear even when they are printed onto large sheets.

MENU → **[Rec]**→**[Picture Size]**

When the aspect ratio is **[4:3]**.

Settings	Image size
[L] (16M)	4592×3448
[EXM] (8M)	3232×2424
[EXS] (4M)	2272×1704

When the aspect ratio is **[3:2]**.

Settings	Image size
[L] (14M)	4592×3064
[EXM] (7M)	3232×2160
[EXS] (3.5M)	2272×1520

When the aspect ratio is **[16:9]**.

Settings	Image size
[L] (12M)	4592×2584
[EXM] (6M)	3232×1824
[EXS] (2M)	1920×1080

When the aspect ratio is **[1:1]**.

Settings	Image size
[L] (11.5M)	3424×3424
[EXM] (6M)	2416×2416
[EXS] (3M)	1712×1712

Setting the compression rate of pictures [Quality]

Applicable modes:

Set the compression rate at which the pictures are to be stored.

MENU → **[Rec]**→**[Quality]**

Settings	File format	Description of settings
[]	JPEG	A JPEG image in which image quality was given priority.
[]		A standard image quality JPEG image. This is useful for increasing the number of shots without changing the number of pixels.
[RAW]	RAW+JPEG	You can record a RAW image and a JPEG image ([] or []) simultaneously.*1
[RAW]		
[RAW]	RAW	You can only record RAW images.*2

*1 If you delete a RAW file from the camera, the corresponding JPEG image will also be deleted.

*2 It is fixed to maximum recordable pixels ([L]) for each image aspect ratio.

• Develop and edit RAW files using the software "SILKYPIX Developer Studio" by Ichikawa Soft Laboratory on the CD-ROM (supplied).

Taking Pictures with Auto Focus

Applicable modes:           

This allows the focusing method that suits the positions and number of the subjects to be selected.

- 1 Set the focus mode lever to [AF].
- 2 Set [AFS/AFF/AFC] in the [Custom] menu to [AFS], [AFF] or [AFC].
(P46)
- 3 Press ◀ ().
- 4 Press ◀/▶ to select AF Mode and then press [MENU/SET].

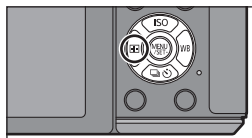

About the focus mode (AFS/AFF/AFC)

Applicable modes:            

1 Select the menu.

MENU → [Custom] → [AFS/AFF/AFC]

2 Press ▲/▼ to select item, and press [MENU/SET].

- Select focus mode according to the movement of the subject and the scene you are recording.
- The set focus mode will be assigned to [AF] of the focus mode lever.



Item	The movement of the subject and the scene (recommended)
AFS	Subject is still (Scenery, anniversary photograph, etc.)
AFF	Movement cannot be predicted (Children, pets, etc.)
AFC	Subject is moving (Sport, trains, etc.)

- When the interchangeable lens (H-H020A) is used, [AFF] and [AFC] cannot be set.

Taking Pictures with Manual Focus

Applicable modes: 

Use this function when you want to fix the focus or when the distance between the lens and the subject is determined and you do not want to activate Auto Focus.

- 1 Set the focus mode lever to [MF].
- 2 Use the focus lever or focus ring on the lens to achieve focus.

(A) Indicator for ∞ (infinity)

- When you focus manually, display is switched to the assist screen and the image is enlarged (MF Assist (B)).
- When [Peaking] in the [Custom] menu is set to [ON], in-focus portions are highlighted (C).
- When [MF Guide] on the [Custom] menu is set to [ON] and you focus manually, the MF guide (D) is displayed on the screen. You can check whether the point of focus is to the near side or the far side.

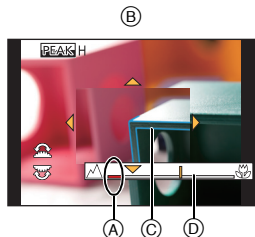

MF ASSIST

■ Displaying the MF Assist

- It can be displayed by rotating the focus ring, moving the focus lever, pinching out (P15) the screen, or touching the screen twice. (In the Creative Control Mode [Miniature Effect], MF Assistance cannot be displayed by touching the screen)
- It can also be displayed by pressing  to display the setup screen for the enlarged area, deciding the area to enlarge using the cursor button, and then pressing [MENU/SET].
- It will switch to the setting screen for the enlarged area by pressing the cursor button when the [Direct Focus Area] in the [Custom] menu is set to [ON].

■ Changing the display of the MF Assist

Each time the rear dial is pressed, an enlarged display switches between a windowed screen display and a full screen display.



- If the front dial or rear dial is rotated, the display can be enlarged/reduced up to approximately 3 to 6 times when the enlarged display is in a windowed display or up to approximately 3 to 10 times when the enlarged display is in a full screen display. The rear dial enlarges/reduces the size at a rate of 1 time, and the front dial enlarges/reduces it at a rate of 0.1 times.
- The display can also be enlarged/reduced by pinching out/pinching in.

■ Moving the enlarged area

- The enlarged area can be moved by dragging the screen (P15), or pressing the cursor button.
- The following will return the MF assistance to the original position.
 - Pressing [DISP.] when the setting screen for determining the area to be enlarged is displayed.

■ Closing the MF Assist

- It will close when the shutter button is pressed halfway.
- You can also close MF Assist by pressing [MENU/SET] or touching [Exit].
- When displayed by moving the focus lever or rotating the focus ring, it is closed approximately 10 seconds after operations are stopped.

Fixing the Focus and the Exposure (AF/AE Lock)

Applicable modes: 

This is useful when you want to take a picture of a subject outside the AF area or the contrast is too strong and you cannot achieve appropriate exposure.

- 1 Align the screen with the subject.**
- 2 Press and hold [AF/AE LOCK] to fix the focus or exposure.**
 - If you release [AF/AE LOCK], AF/AE Lock is canceled.
 - Only the exposure is locked in the default setting.
- 3 While pressing [AF/AE LOCK], move the camera as you compose the picture and then press shutter button fully.**

 AE Lock indication

- When [AE LOCK] is set, after pressing the shutter button halfway to focus, press the shutter button fully.

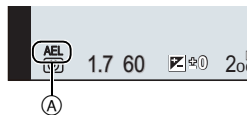

Compensating the Exposure

Applicable modes:         

Use this function when you cannot achieve appropriate exposure due to the difference in brightness between the subject and the background.

- 1 Press the rear dial to switch to Exposure Compensation operation.

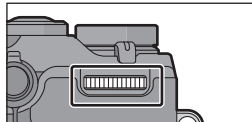

- 2 Rotate the rear dial to compensate the exposure.

(A) Exposure Compensation value

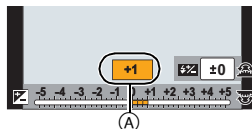

- Select [±0] to return to the original exposure.

Setting the Light Sensitivity

Applicable modes:         

This allows the sensitivity to light (ISO sensitivity) to be set. Setting to a higher figure enables pictures to be taken even in dark places without the resulting pictures coming out dark.

- 1 Press  (ISO).
- 2 Select the ISO sensitivity by rotating the rear dial.
- 3 Press the rear dial to set.

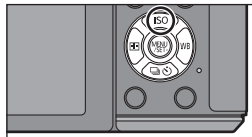

Select a Drive Mode

Applicable modes: **[P]** **[A]** **[S]** **[M]** **[C1]** **[C2]** **[C3]** **[SCN]** **[REPEAT]**

Selecting the drive mode allows you to switch the operation, such as burst recording or the self-timer, for when you press the shutter button.

1 Press **▼** ( .

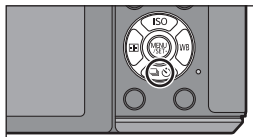

2 Press **◀/▶** to select the drive mode, and then press **[MENU/SET]**.

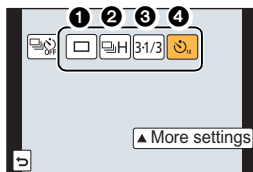

Drive mode	Description of settings
1 [Single] (P24)	When the shutter button is pressed, only one picture is recorded.
2 [Burst] (P51)	Recordings are made in succession while the shutter button is pressed.
3 [Auto Bracket] (P53)	Each time the shutter button is pressed, recordings are made with different exposure settings according to the Exposure Compensation range.
4 [Self Timer] (P54)	When the shutter button is pressed, recording takes place after the set time has elapsed.



- To cancel the drive mode, select **[OFF]**. The setting will switch to [Single].
- Settings for each drive mode can be changed by pressing **▲**.

Taking Pictures using Burst Mode

Applicable modes:   **P** **A** **S** **M**  **C1** **C2** **C3**  

Pictures are taken continuously while the shutter button is pressed.

• Pictures taken with a burst speed of [SH] will be recorded as a single burst group.

- 1** Press **▼** ( .
- 2** Press **◀/▶** to select the burst icon (, etc.), and then press **▲**.
- 3** Select the burst speed with **◀/▶**, and then press **[MENU/SET]**.

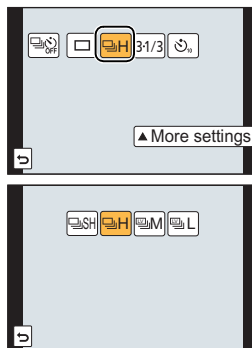

		[SH] ^{*2} (Super high speed)	[H] (High speed)	[M] (Middle speed)	[L] (Low speed)
Burst speed (pictures/ second)	Electronic shutter [ON]	40	10	4	2
	Electronic shutter [OFF]		5	4	2
Live View during Burst Mode		None	None	Available	Available
*1	With RAW files	—	g ^{*3,4}		
	Without RAW files	Max. 80	Depends on the capacity of the card ^{*4}		

*1 Number of recordable pictures

*2 The electronic shutter will operate.

*3 Depending on the recording conditions, the number of frames in a burst may be reduced. (For example, when you set [i.Resolution] of the recording menu, the number of frames in a burst may be reduced)

*4 Pictures can be taken until the capacity of the card becomes full. However the burst speed will become slower halfway. The exact timing of this depends on the aspect ratio, the picture size, the setting for the quality and the type of card used.

4 Focus on the subject and take a picture.



- Hold down the shutter button fully to activate the Burst Mode.

■ Focusing in Burst Mode

Focus Mode	Focus/Release Priority	Focus
AFS	[FOCUS]	At the first picture
	[RELEASE]	
AFF/AFC ^{*5}	[FOCUS]	Normal focusing ^{*6}
	[RELEASE]	Predicted focusing ^{*7}
MF	—	Focus set with Manual Focus

*5 When the subject is dark or the burst speed is set to [SH], the focus is fixed on the first picture.

*6 The burst speed may become slower because the camera is continuously focusing on the subject.

*7 Burst speed takes priority, and focus is estimated within possible range.

Taking Pictures using Auto Bracket

Applicable modes:

Maximum of 7 pictures will be recorded with different exposure settings following the Exposure Compensation range every time the shutter button is pressed.

- 1 Press **▼** ().
- 2 Press to **◀/▶** to select the Auto Bracket icon ([3:1/3], etc.), and then press **▲**.

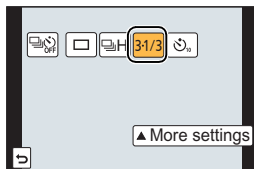

- 3 Press **◀/▶** to select the compensation range, and then press **[MENU/SET]**.

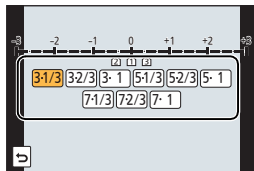

- 4 Focus on the subject and take a picture.

(A) Auto Bracket indication

- If you press and hold the shutter button, the number of pictures that you set is taken.
- The Auto Bracket indication blinks until the number of pictures that you set is taken.
- The picture count is reset to [0] if you change the Auto Bracket setting or turn the camera off before all the pictures that you set are taken.

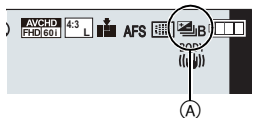

■ Changing the settings for [Single/Burst Settings], [Step] and [Sequence] in Auto Bracket

- 1 Select the menu.

MENU → **[Rec]** → **[Auto Bracket]**

- 2 Press **▲/▼** to select [Single/Burst Settings], [Step] or [Sequence] and then press **[MENU/SET]**.
- 3 Press **▲/▼** to select the setting and then press **[MENU/SET]**.
 - Exit the menu after it is set.

Taking Pictures with the Self-timer

Applicable modes:   **P** **A** **S** **M**  **C1** **C2** **C3**  

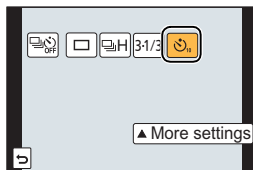

1 Press **▼** ( .

2 Press **◀/▶** to select the self-timer icon (, etc.), and then press **▲**.

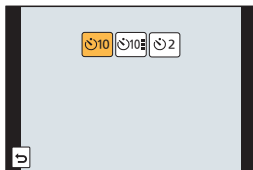

3 Press **◀/▶** to select the time setting for the self-timer, and then press **[MENU/SET]**.



Item	Description of settings
	Picture is taken 10 seconds after shutter is pressed.
	After 10 seconds the camera takes 3 pictures at about 2 seconds intervals.
	Picture is taken 2 seconds after shutter is pressed. • When using a tripod, etc., this setting is a convenient way to avoid the jitter caused by pressing the shutter button.

4 Press the shutter button halfway to focus and then press it fully to take the picture.

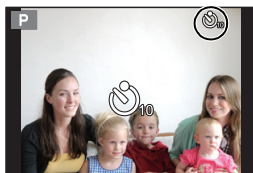

Optical Image Stabilizer

The camera detects jitter during recording and automatically corrects it, so you can record images with reduced jitter.

There are two types of Optical Image Stabilizers, the one built into a lens and the one built into this unit. The Optical Image Stabilizer of either a lens or this unit will be enabled.

■ Compatible Optical Image Stabilizers

The Optical Image Stabilizer of either a lens or this unit works depending on the lens in use.

Lens in use		Optical Image Stabilizer function	
Micro Four Thirds mount specification lens	Supporting the Optical Image Stabilizer function • The interchangeable lens (H-FS1442A) supports the Optical Image Stabilizer function.	Only the Optical Image Stabilizer function of the lens will be enabled.	P56
	Not supporting the Optical Image Stabilizer function • The interchangeable lens (H-H020A) does not support the Optical Image Stabilizer function.	Only the Optical Image Stabilizer function of this unit will be enabled.	P57
Four Thirds mount specification lens • Use a mount adaptor (DMW-MA1: optional).	Supporting the Optical Image Stabilizer function	Only the Optical Image Stabilizer function of the lens will be enabled.	P56
	Not supporting the Optical Image Stabilizer function	Only the Optical Image Stabilizer function of this unit will be enabled.	P57
Leica mount specification lens • Use a Leica lens mount adaptor (DMW-MA2M, DMW-MA3R: optional).		Only the Optical Image Stabilizer function of this unit will be enabled.	P57
Lenses other than those listed above that can be attached to this unit		Only the Optical Image Stabilizer function of this unit will be enabled.	P57

Using the Optical Image Stabilizer function of a lens





Applicable modes:   **P** **A** **S** **M**  **C1** **C2** **C3**  

A lens based on the Micro Four Thirds System standard/Four Thirds System standard equipped with the Optical Image Stabilizer function is required. (P55)

1 Select the menu.

MENU → [Rec] → [Stabilizer] → [Operation Mode]

2 Press ▲/▼ to select the item and then press [MENU/SET].

Item	Description of settings
  [Normal]	Vertical and horizontal shake are compensated for.
  [Panning]	Camera shake is corrected for up/down movements. This mode is ideal for panning (a method of taking pictures which involves turning the camera to track the movements of a subject which continues to move in a fixed direction).
[OFF]	[Stabilizer] does not work. (This can be selected only when using a lens without the [O.I.S.] switch.)

- Exit the menu after it is set.
- When using an optional interchangeable lens with an O.I.S. switch, it is possible to set to enable the Optical Image Stabilizer by switching the O.I.S. switch on the lens to [ON]. (At the time of purchase, it is initially set to .)

Using the Optical Image Stabilizer function of this unit

Applicable modes: 

If your lens does not support the Optical Image Stabilizer function or is not based on the Micro Four Thirds System standard/Four Thirds System standard, the Optical Image Stabilizer of this unit can be used. (P55)

- The Optical Image Stabilizer of this unit works only when taking pictures.



If your lens is not based on the Micro Four Thirds System standard/Four Thirds System standard, make the following settings:

- Set the [Shoot w/o Lens] to [ON]. (P85)
- Set the focal length of your lens in [Focal Length Set]. (P58)
 - If a lens not based on the Micro Four Thirds System standard/Four Thirds System standard is in use when the Optical Image Stabilizer of this unit is available, a confirmation message for the focal length setting is displayed after this unit is turned on. Selecting [Yes] enables you to set [Focal Length Set] in [Stabilizer].

1 Select the menu.

MENU → [Rec] → [Stabilizer]

2 Press ▲/▼ to select the item and then press [MENU/SET].

Item	Description of settings	
[Operation Mode]	<small>BODY</small> [ ([Normal])]	Vertical and horizontal shake are compensated for.
	<small>BODY</small> [ ([Panning])]	Camera shake is corrected for up/down movements. This mode is ideal for panning (a method of taking pictures which involves turning the camera to track the movements of a subject which continues to move in a fixed direction).
	[OFF]	[Stabilizer] does not work.
[Focal Length Set]*	The focal length of your lens can be set or registered.	

* This item can be set only when your lens is not based on the Micro Four Thirds System standard/Four Thirds System standard.

- Exit the menu after it is set.

Setting the focal length of a lens

- When a lens based on the Micro Four Thirds System standard/Four Thirds System standard is in use, a focal length is set automatically.
- If your lens is based on the Micro Four Thirds System standard/Four Thirds System standard but does not have a communication function with the camera, set the focal length of the lens.

Preparations: Set the [Shoot w/o Lens] to [ON]. (P85)

1 Select the menu.

MENU → **[Rec]** → **[Stabilizer]**

2 Press ▲/▼ to select **[Focal Length Set]** and then press **[MENU/SET]**.

3 Select the focal length of your lens with ◀/▶.

- A focal length ranging from 8 mm to 1000 mm can be set.
- Set a focal length written on the body of your lens, etc.
- If the focal length setting for your lens is not found, select a value close to the focal length of your lens.
- If your lens is a zoom lens, select a value according to the focal length at the time of recording.



4 Press **[MENU/SET]**.

■ Registering a focal length

1 Perform step 3 in “Setting the focal length of a lens”.

2 Press ▼.

3 Press ◀/▶ to select the focal length to be overwritten and then press **[DISP.]**.

- Confirmation screen is displayed. It is executed when [Yes] is selected.
- Up to 3 focal length settings can be registered.
- Exit the menu after it is set.



■ Setting a registered focal length

1 On the screen in step 3 of “Setting the focal length of a lens”, press ▼.

2 Press ◀/▶ to select the registered focal length and then press **[MENU/SET]**.

Taking Pictures with the Zoom

Applicable modes:   **P** **A** **S** **M**  **C1** **C2** **C3**  

■ Types of zooms and recording magnification

Feature	Optical Zoom	Extended Tele Conversion (EX) (P82)	Digital Zoom (P82)
Recording magnification	Different depending on the lens used.	When taking still pictures: Max. $2\times^{*1}$ When recording motion pictures: $2.4\times^{*2}$	When selecting [2×] When selecting [4×]
Picture quality	No deterioration	No deterioration	The higher the magnification level, the greater the deterioration.

*1 When a picture size of [S] (4 M), aspect ratio of [4:3] is selected.

The magnification level differs depending on [Picture Size] and [Aspect Ratio] setting.

*2 When recording quality setting [FHD/60p], [FHD/60i], [FHD/30p] or [FHD/24p] is selected.

Taking pictures by using the flash

Applicable modes: **P** **A** **S** **M** **C1** **C2** **C3**

■ Open/Close the built-in flash

Taking a picture using the flash becomes possible by opening the built-in flash.

Ⓐ To open the flash

Slide the flash open lever.

Ⓑ To close the flash

Press the flash until it clicks.

- Make sure to close the built-in flash when it is not in use.
- The flash setting is fixed to while the flash is closed.

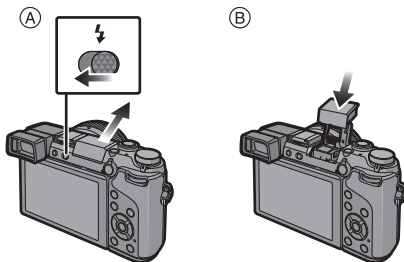

Changing Flash Mode

Applicable modes: **P** **A** **S** **M** **C1** **C2** **C3**

Set the built-in flash to match the recording.

- Open the flash.

1 Select the menu.

MENU → **[Rec]** → **[Flash]**

2 Press **▲/▼** to select **[Flash Mode]** and then press **[MENU/SET]**.

3 Press **▲/▼** to select the item and then press **[MENU/SET]**.

Switching the Playback Method

Displaying multiple screens (Multi Playback)

Rotate the rear dial left.

1 screen → 12 screens → 30 screens → Calendar screen display

- It is possible to switch the playback screen by touching the following icons.

– []: 1 screen

– []: 12 screens

– []: 30 screens

– []: Calendar screen display

- The screen can be switched gradually by dragging the screen up or down.

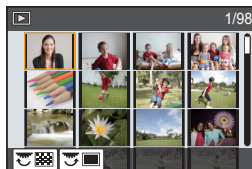

Displaying Pictures by Recording Date (Calendar Playback)

1 Rotate the rear dial left to display the Calendar screen.

2 Press **▲/▼/◀/▶** to select the date to be played back.

- If there were no pictures recorded during a month, that month is not displayed.

3 Press **[MENU/SET]** to display the images that are recorded in selected date.

4 Press **▲/▼/◀/▶** to select a picture and then press **[MENU/SET]**.



Using Playback Functions

With this menu, you can use various playback functions such as cropping and other editing of recorded images, protect settings, etc.

Creating Still Pictures from a Motion Picture

You can create a single still picture from a recorded motion picture.

1 Press ▲ to pause motion picture playback.

2 Press [MENU/SET].

- The same operation can be performed by touching [].
- Confirmation screen is displayed. It is executed when [Yes] is selected.



Removing unnecessary parts [Clear Retouch]

You can erase unnecessary parts recorded on the pictures taken.

- The erasure operation can only be performed by touching. [Clear Retouch] automatically enables the touch operation.

1 Select the menu.

MENU → **[Playback]** → **[Clear Retouch]**

2 Press ◀/▶ to select a picture, and then press [MENU/SET].

3 Drag your finger over the part you want to delete.

- The parts to be erased are colored.
- Touching [Undo] will return the colored part back to its previous state.

4 Touch [Set].

- Preview screen is displayed.

5 Touch [Save] or press [MENU/SET].

- Confirmation screen is displayed. It is executed when [Yes] is selected. Exit the menu after it is executed.



What you can do with the Wi-Fi® function

What you can do

Controlling with a Smartphone/Tablet

Recording with a smartphone.

Saving images stored in the camera.

Sending images to an SNS.



 **Easy connection, easy transfer**
You can use easily by pressing and holding [Wi-Fi] or by using the NFC function.

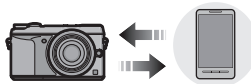

Displaying pictures on a TV



When sending images to Printer

When sending images to AV device

You can send pictures and motion pictures to AV devices in your house (home AV devices). You can also send them to the devices (external AV devices) of your family or friends living away from you via "LUMIX CLUB".



When sending images to PC

Using Web services

You can send pictures and motion pictures to an SNS, etc. via "LUMIX CLUB". By setting up automatic transfers of pictures and motion pictures to the [Cloud Sync. Service], you can receive the transferred pictures or motion pictures on a PC or smartphone.

• Please refer to "Owner's Manual for advanced features (PDF format)" for details.

Controlling with a Smartphone/Tablet

You can remotely operate the camera using a smartphone/tablet.

You need to install “Panasonic Image App” (referred to as “Image App” from this point on) on your smartphone/tablet.



Installing the smartphone/tablet app “Panasonic Image App”

The “Image App” is an application provided by Panasonic.

	For Android™ apps	For iOS apps
OS	Android 2.2~Android 4.2*	iOS 5.0~iOS 6.1
Installation procedure	<ol style="list-style-type: none"> 1 Connect your Android device to a network. 2 Select “Google Play™ Store”. 3 Enter “Panasonic Image App” into the search box. 4 Select “Panasonic Image App” and install it. <p>• The icon will be added to the menu.</p> 	<ol style="list-style-type: none"> 1 Connect the iOS device to the network. 2 Select “App Store™”. 3 Enter “Panasonic Image App” into the search box. 4 Select “Panasonic Image App” and install it. <p>• The icon will be added to the menu.</p> 

- Use the latest version.
 - The service may not be able to be used properly depending on the type of smartphone/tablet being used. For information on the Image App, refer to the support site below.
<http://panasonic.jp/support/global/cs/dsc/> (This Site is English only.)
 - When downloading the app on a mobile network, high packet communication fees may be incurred depending on the details of your contract.
- * Connecting to this unit with [Wi-Fi Direct] requires Android OS 4.0 or higher and Wi-Fi Direct™ support.

Connecting to a smartphone/tablet

A connection can be easily established by pressing and holding [Wi-Fi] or by using the NFC function.

Preparations:

- Install the "Image App" in advance. (P64)

1 Press and hold [Wi-Fi].

- The information (SSID and password) required for directly connecting your smartphone/tablet to this unit is displayed.
- Except for when connecting for the first time, the screen from the previous connection is displayed.
- The same screen can be displayed by selecting the following menu items.

Wi-Fi → **[New Connection]** → **[Remote Shooting & View]**

- To change the connection method, press [DISP.], and then select the connection method.

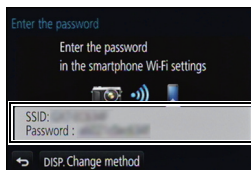

2 Operate the smartphone/tablet.

- 1 Turn on the Wi-Fi function.
- 2 Select the SSID that matches the one displayed on the screen of this unit, and then enter the password.
- 3 Start "Image App". (P64)
 - When the connection is complete, live images being captured by the camera are displayed on the smartphone/tablet.

Connecting to a smartphone/tablet by using the NFC function

Using the NFC “Near Field Communication” function, you can easily transfer data necessary for a Wi-Fi connection between this camera and the smartphone/tablet.

Compatible models

This function can be used with the NFC compatible device with Android (OS version 2.3.3 or higher). (excluding some models)

- For information on the operation and settings of NFC-compatible smartphones/tablets, refer to the owner’s manual of your device.

Preparation:

(On the camera)

- Set [NFC Operation] to [ON].

(On your smartphone/tablet)

- Check that your smartphone/tablet is a compatible model.
- Turn on the Wi-Fi function.
- Install the “Image App” in advance. (P64)

1 Launch “Image App” on your smartphone/tablet.

2 While [] is displayed on the connection screen of the “Image App”, touch the smartphone/tablet to [] of this unit.

- It may take time to complete the connection.
- When the smartphone/tablet has connected, an image of this camera will be displayed on the smartphone/tablet.
- If a connection attempt by touching fails, restart the “Image App”, and then display the screen in step **1** again.
- If a connection is established during single picture playback, the picture will be transferred to the smartphone/tablet. (P68)

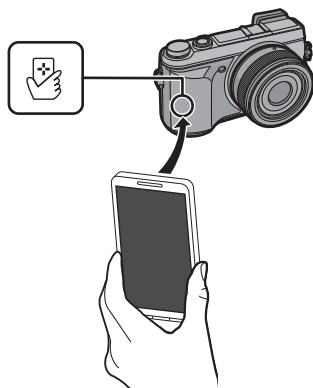

When connecting for the first time, the connection confirmation screen is displayed

1 When the connection confirmation screen is displayed on this unit, select [Yes].

2 Touch the smartphone/tablet to [] of the camera again.

- The connected smartphone/tablet is registered to this camera.

Taking pictures via a smartphone/tablet (remote recording)

- 1 **Connect to a smartphone/tablet. (P65)**
- 2 **Select [] on the smartphone/tablet.**
 - The recorded images are saved in the camera.
 - Motion pictures can also be recorded.
 - Some settings are not available.
 - The screen differs depending on the operating system.

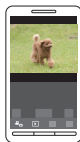

Saving images stored in the camera/Sending images in the camera to an SNS

- 1 **Connect to a smartphone/tablet. (P65)**
- 2 **Select [] on the smartphone/tablet.**
- 3 **Drag an image.**
 - The function can be assigned to the top, bottom, left or right according to your preference.
 - If an image is touched, the picture will be played back in an enlarged size.



Transferring images stored in the camera easily

A Wi-Fi connection using NFC function is possible by touching the smartphone/tablet to this unit, and you can easily transfer images displayed on the screen.

An image can be sent on site immediately after taking it, so you can easily send it to the smartphone/tablet* of your family or friend.

* Installing the “Image App” is required for use.

Preparation:

(On the camera)

- Set [NFC Operation] to [ON].
- Set [Touch Sharing] to [ON].

(On your smartphone/tablet)

- Check that your smartphone/tablet is a compatible model.
- Turn on the Wi-Fi function.
- Install the “Image App” in advance. (P64)

- 1 Play back the picture you want to transfer to the smartphone/tablet in the camera.**
- 2 Launch “Image App” on the smartphone/tablet at the transfer destination.**
- 3 While [] is displayed on the connection screen of the “Image App”, touch the smartphone/tablet to [] of this unit.**
 - It may take time to complete the connection.
 - If a connection attempt by touching fails, restart the “Image App”, and then display the screen in step 2 again.
 - They cannot be transferred as a batch.

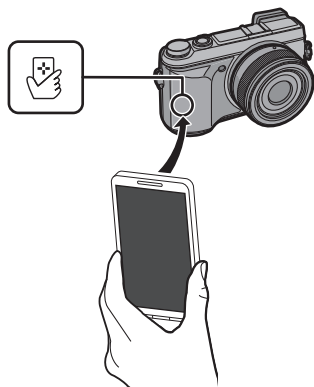

• Depending on the environment you are using, it may take a few minutes to complete the image transfer.

Changing the connection method

To change the connection method, press [DISP.], and then select the connection method.

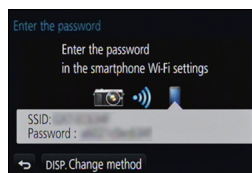

Connection method	Description of settings	
[Via Network]	Connects via a wireless access point.	P70
[Direct]	Your device connects directly to this unit.	P72

Via the network

You can select the method for connecting to a wireless access point.

- * WPS refers to a function that allows you to easily configure the settings related to the connection and security of wireless LAN devices. To check if the wireless access point you are using is compatible with WPS, refer to the manual of the wireless access point.

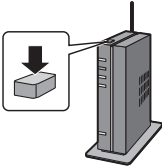

Connection method	Description of settings
[WPS (Push-Button)]	<p>Save push button type wireless access point that is compatible with Wi-Fi Protected Setup™ with a WPS mark.</p> <p>Press the wireless access point WPS button until it switches to WPS mode. e.g.:</p> <ul style="list-style-type: none"> • Refer to the wireless access point instruction manual for details. 
[WPS (PIN code)]	<p>Save PIN code type wireless access point that is compatible with Wi-Fi Protected Setup with a WPS mark.</p> <ol style="list-style-type: none"> Select the wireless access point you are connecting to. Enter the PIN code displayed on the camera screen into the wireless access point. Press [MENU/SET]. <ul style="list-style-type: none"> • Refer to the wireless access point instruction manual for details.
[Manual Connection]	<p>Select this option when you are not sure about the WPS compatibility, or when you want to search for and connect to a wireless access point.</p> <ul style="list-style-type: none"> • Refer to P71 for details.

If you are not sure about the WPS compatibility (connecting by [Manual Connection])

Search for available wireless access points.

- Confirm encryption key of the selected wireless access point if the network authentication is encrypted.
- When connecting by [Manual Input], confirm SSID, encryption type, encryption key of the wireless access point you are using.

1 Select the wireless access point you are connecting to.

- Pressing [DISP.] will search for a wireless access point again.
- If no wireless access point is found, refer to “When connecting with [Manual Input]” on P71.

2 (If network authentication is encrypted) Enter the encryption key.

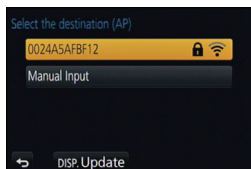

■ When connecting with [Manual Input]

1 On the screen displayed in step 1 of “If you are not sure about the WPS compatibility (connecting by [Manual Connection])”, select [Manual Input].

2 Enter the SSID of the wireless access point you are connecting to, then select [Set].

3 Select the network authentication type.

- For information on network authentication, see the manual of the wireless access point.

4 Select the encryption type.

- The type of settings that can be changed may vary depending on the details of network authentication settings.

Network authentication type	Encryption types that can be set
[WPA2-PSK]/[WPA-PSK]	[TKIP]/[AES]
[Common Key]	[WEP]
[Open]	[No Encryption]/[WEP]

5 (When an option other than [No Encryption] is selected) Enter the encryption key.

- Check the wireless access points instruction manual and settings when saving a wireless access point.
- Transmission speed may decrease, or may not be usable depending on the environment it is used in.

Direct connection

You can select the method for connecting to the device you are using.

Select the connection method supported by your device.



Connection method	Description of settings
[Wi-Fi Direct]	<ol style="list-style-type: none"> 1 Set the device to Wi-Fi Direct™ mode. 2 Select [Wi-Fi Direct]. 3 Select the device to connect to. <ul style="list-style-type: none"> • Read the owner's manual of your device for details.
[WPS Connection]	[WPS (Push-Button)] <ol style="list-style-type: none"> 1 Select [WPS (Push-Button)]. 2 Set the device to WPS mode. <ul style="list-style-type: none"> • You can wait longer for a connection by pressing the [DISP.] button on this unit.
	[WPS (PIN code)] <ol style="list-style-type: none"> 1 Select [WPS (PIN code)]. 2 Enter the PIN code of the device into this unit.
[Manual Connection]	<p>Enter the SSID and password into the device. The SSID and password are displayed on the connection waiting screen of this unit.</p>

About the supplied software

The supplied CD-ROM includes the following software.
Install the software on to your computer before use.

- **PHOTOfunSTUDIO 9.2 PE (Windows XP/Vista/7/8)**

This software allows you to manage images. For example, you can send pictures and motion pictures to a PC and sort them by recording date or model name. You can also perform operations such as writing images to a DVD, processing and correcting images, and editing motion pictures.

- **SILKYPIX Developer Studio (Windows XP/Vista/7/8, Mac OS X v10.4/v10.5/v10.6/v10.7/v10.8)**

This is software to edit RAW format images.

Edited images can be saved in a format (JPEG, TIFF, etc.) that can be displayed on a personal computer.

**For details on how to use the SILKYPIX Developer Studio, refer to the “Help” or the Ichikawa Soft Laboratory’s support website:
<http://www.isl.co.jp/SILKYPIX/english/p/support/>**

- **LoiLoScope 30 day full trial version (Windows XP/Vista/7/8)**

LoiLoScope is a video editing software where that draws out the full power of your PC. Creating videos is as easy as organizing cards on top of a desk. Use your music, picture and video files to create videos to share with your friends and family by burning it to a DVD, uploading it to websites, or simply share your videos with your friends via e-mail.

– This will only install a shortcut to the trial version download site.

**For more information on how to use LoiLoScope, read the LoiLoScope manual available for download at the link below.
Manual URL: <http://loilo.tv/product/20>**

■ Installing supplied software

- Before inserting the CD-ROM, close all running applications.

1 Check the environment of your PC.

• Operating environment of “PHOTOfunSTUDIO 9.2 PE”

– OS:

Windows® XP (32bit) SP3,
Windows Vista® (32bit) SP2,
Windows® 7 (32bit/64bit) or SP1,
Windows® 8 (32bit/64bit)

– CPU:

Pentium® III 500 MHz or higher (Windows® XP),
Pentium® III 800 MHz or higher (Windows Vista®),
Pentium® III 1 GHz or higher (Windows® 7/Windows® 8)

– Display:

1024×768 pixels or more (1920×1080 pixels or more recommended)

– RAM:

512 MB or more (Windows® XP/Windows Vista®),
1 GB or more (Windows® 7 32bit/Windows® 8 32bit),
2 GB or more (Windows® 7 64bit/Windows® 8 64bit)

– Free hard disk space:

450 MB or more for installing software

- Refer to the operating instructions of “PHOTOfunSTUDIO” (PDF) for further operating environment.
- For details on SILKYPIX Developer Studio 3.1 SE, please read the support site given on P73.

2 Insert the CD-ROM with the supplied software.

- When you insert the supplied CD-ROM, the install menu will start.

3 Click on the [Recommended Installation].

- Proceed with installation according to messages appearing on the screen.

- The software compatible with your PC will be installed.
- On the Mac, SILKYPIX can be installed manually.

- 1 Insert the CD-ROM with the supplied software.
- 2 Double-click on the automatically displayed folder.
- 3 Double-click the icon in the application folder.

Not available in these cases:

- “PHOTOfunSTUDIO” and “LoiLoScope” are not compatible with Mac.

Monitor Display/Viewfinder Display

- The following images are examples of when the display screen is set to [] (monitor style) in the monitor.

■ In recording

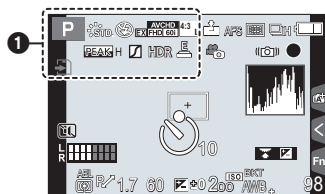

1

	Recording Mode
C 1	Custom settings
	Photo Style
	Creative control adjustment display
	Flash Mode
	Flash
	Extended Tele Conversion (when recording motion pictures)
	Recording format/Recording quality
	Picture size/Aspect Ratio
	Extended Tele Conversion (when taking still pictures)

	Card (displayed only during recording)
8m30s	Elapsed recording time*
	Simultaneous recording indicator
	Peaking
	Highlight Shadow
HDR	HDR
	Multi exposure
	Digital Zoom
	Electronic shutter
	Overheat indicator

- * “h” is an abbreviation for hour, “m” for minute and “s” for second.

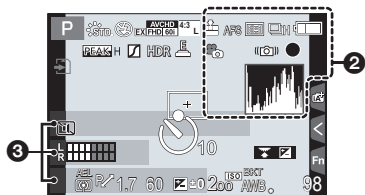

2

	RAW	Quality
	AFS AFF AFC	Focus Mode
	AF Mode	
	Face Recognition	
	AFL	AF Lock
	Burst	
	Auto Bracket	
	Self-timer	
	Battery indication	
	Picture Mode (Still picture priorities)	
	Optical Image Stabilizer	
	Jitter alert	
	Recording state (Flashes red.)	
	Focus (Lights green.)	
	Time Lapse Shot	
	Histogram	

3

Name*¹

Number of days that have passed since the departure date*²

Age*¹

Location*²

Current date and time/✈️: Travel destination setting*²

*1 This is displayed for about 5 seconds when the camera is turned on if the [Profile Setup] setting is set.

*2 This is displayed for about 5 seconds when the camera is turned on, after setting the clock and after switching from Playback Mode to Recording Mode.

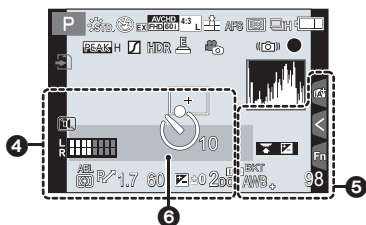

	AF area
+	Spot metering target
	Self-timer ^{*1}
	Mic level display
	Silent Mode
AEL	AE Lock
	Metering Mode
P	Program Shift
1.7	Aperture value
60	Shutter speed
	Exposure compensation value
	Brightness
	Manual Exposure Assistance
200 ^{ISO}	ISO sensitivity

*1 This is displayed during countdown.

*2 It is possible to switch the display between the number of recordable pictures and available recording time with the [Remaining Disp.] setting in the [Custom] menu.

*3 "h" is an abbreviation for hour, "m" for minute and "s" for second.

*4 Only displayed in the monitor.

	Dial operation guide
BKT AWB+	White Balance Bracket
	White Balance Fine Adjustment
	White Balance
	Color
98	Number of recordable pictures ⁺²
R8m30s	Available recording time ^{+2,3}
	Touch tab ⁺⁴
	Touch tab ⁺⁴
	Touch tab ⁺⁴
	Touch tab ⁺⁴
	Touch tab ⁺⁴
	Touch tab ⁺⁴

6	Exposure meter
	Focal distance display
	Step zoom

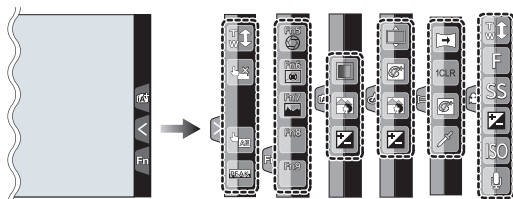

- Only displayed in the monitor.

	Touch zoom		One point color
	Touch Shutter		Position of the light source
	Touch AE		Creative control adjustment
	Peaking		Panorama shot direction
	Fn5 (Function button)		Selects an image effect (filter)
	Fn6 (Function button)		
	Fn7 (Function button)		Aperture value
	Fn8 (Function button)		Shutter speed
	Fn9 (Function button)		ISO sensitivity
	Color		Microphone level adjustment
	Defocus control function		
	Brightness		
	Type of defocus ([Miniature Effect])		

■ In playback

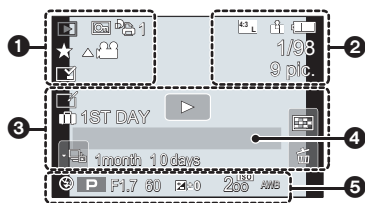

	Playback Mode
	Protected picture
	Number of prints
	Favorites
	Cable disconnect prohibit icon
	Motion picture playback
	Play panorama
	Continuous Burst Picture Group Playback
	Continuous [Time Lapse Shot] Picture Group Playback
	Continuous playback of the Stop Motion Animation Group
	Stamped with text indication
8m30s	Elapsed playback time ^{*1}

	Picture size/ Aspect Ratio
	Recording format/ Recording quality
	RAW
	Battery indication
1/98	Picture number/Total pictures
9 pic.	Number of pictures in burst
8m30s	Motion picture recording time ^{*1}

	Clear Retouch completed icon
	Currently retrieving information icon
	Playback (Motion Pictures)
	Number of days that have passed since the departure date
	Burst Picture Group Display
	[Time Lapse Shot] Picture Group Display
	Display for the Stop Motion Animation Group
	Silent Mode
1 month 10days	Age
	Multi Playback
	Delete

	Name ^{*2}
	Location ^{*2}
	Title ^{*2}
	Recording information ^{*3}

*1 "h" is an abbreviation for hour, "m" for minute and "s" for second.

*2 It is displayed in order of [Title], [Location], [Name] ([Baby1]/[Baby2], [Pet]), [Name] ([Face Recog.]).

*3 This is not displayed for motion pictures recorded in [AVCHD].

Detailed information display

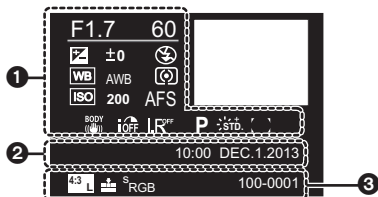

1

Recording information

	Intelligent Dynamic Range Control ^{*1}
	HDR ^{*2}
	Intelligent Resolution
	Shading Compensation ^{*2}

2

Recorded date and time/World Time

	Picture size/ Aspect Ratio
	Quality
	Color space ^{*2}
100-001	Folder/File number ^{*1}

3

Histogram display

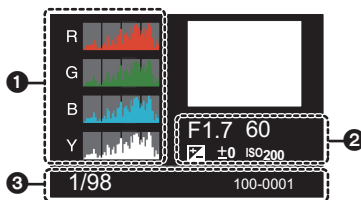

1

Histogram

2

Recording information^{*1}

3

1/98	Picture number/Total pictures
100-001	Folder/File number ^{*1}

*1 This is not displayed for motion pictures recorded in [AVCHD].

*2 This is not displayed for motion pictures.

Menu list

[Rec]

This menu lets you set the aspect ratio, number of pixels and other aspects of the pictures you are recording.

• [Photo Style], [Metering Mode], [Highlight Shadow], [i.Dynamic], [i.Resolution] and [Digital Zoom] are common to both the [Rec] menu and [Motion Picture] menu. Changing these settings in one of these menus is reflected in other menu.

[Photo Style]	You can select effects to match the type of image you wish to record. You can adjust the color and image quality of the effects. (P40)
[Aspect Ratio]	Sets the aspect ratio of the image. (P43)
[Picture Size]	Set the number of pixels. (P44)
[Quality]	Set the compression rate at which the pictures are to be stored. (P44)
[Metering Mode]	Sets the light metering method for measuring brightness.
[Burst Rate]	Sets the burst speed for burst recording.
[Auto Bracket]	Sets single/burst recording, compensation range and recording sequence for Auto Bracket recording. (P53)
[Self Timer]	Sets the manner in which the self-timer works. (P54)
[Highlight Shadow]	You can adjust the brightness of bright and dark portions on an image while checking the brightness on the screen. (P42)
[i.Dynamic] (Intelligent dynamic range control)	Adjusts the contrast and exposure.
[i.Resolution]	Records pictures with more defined outlines and sense of clarity.
[HDR]	You can combine 3 pictures with different levels of exposure into a single picture with rich gradation.
[Multi Exp.]	Gives an effect like multi exposure. (up to 4 times equivalent per a single image)
[Time Lapse Shot]	You can set the recording start time, the recording interval and the number of pictures, and automatically record subjects such as animals and plants as time elapses.

[Stop Motion Animation]	A stop motion picture is created by splicing pictures together.
[Panorama Settings]	Sets the recording direction and image effect for panorama recording.
[Electronic Shutter]	The shutter sound can be turned off for recording in a quiet environment.
[Shutter Delay]	To reduce the influence of hand shake, the shutter is released when a specified time period has elapsed since the shutter button was pressed.
[Flash]	Sets the manner in which the flash works. (P60)
[Red-Eye Removal]	Automatically detects red-eye caused by the flash and corrects the image data accordingly.
[ISO Limit Set]	When the ISO sensitivity is set to [AUTO] or [ISO], an optimal ISO sensitivity is set with the selected value as an upper limit.
[ISO Increments]	The ISO sensitivity settings values changes in steps of 1/3 EV or 1 EV.
[Extended ISO]	ISO sensitivity can be set up to minimum [ISO125].
[Long Shtr NR]	You can eliminate the noise caused by recording with a slower shutter speed.
[Shading Comp.]	If the screen periphery darkens as a result of lens characteristics, the brightness in this region will be corrected.
[Ex. Tele Conv.]	When the number of pixels is set to anything other than [L], the Tele effect is increased without degradation in image quality.
[Digital Zoom]	Increases the Tele effect. The higher the level of magnification, the greater the degradation in image quality.
[Color Space]	Set this when you want to correct the color reproduction of the recorded pictures on a PC, printer etc.
[Stabilizer]	When camera shake is sensed during recording, the camera corrects it automatically.
[Face Recog.]	Sets the focus and exposure automatically prioritizing registered faces.
[Profile Setup]	If you set the name and birthday of your baby or pet in advance, you can record their name and age in months and years in the images.

[Motion Picture]

This menu lets you set the [Rec Format], [Rec Quality], and other aspects for motion picture recording.

- [Photo Style], [Metering Mode], [Highlight Shadow], [i.Dynamic], [i.Resolution] and [Digital Zoom] are common to both the [Rec] menu and [Motion Picture] menu. Changing these settings in one of these menus is reflected in other menu.

– For details, refer to the explanation for the corresponding setting in the [Rec] menu.



[Rec Format]	Sets the file format for the motion pictures you record.
[Rec Quality]	This sets up the picture quality of motion pictures.
[Exposure Mode]	Select the method for setting the aperture value and shutter speed in Creative Video Mode.
[Picture Mode]	Sets the recording method for still pictures during motion picture recording.
[Continuous AF]	Continues to focus on the subject for which focus has been achieved.
[Rec Highlight]	White saturated areas appear blinking in black and white.
[Ex. Tele Conv.]	Increases the Tele effect. (P59)
[Flkr Decrease]	The shutter speed can be fixed to reduce the flicker or striping in the motion picture.
[Silent Operation]	Enables touch operations to allow silent use while recording motion pictures.
[Mic Level Disp.]	Set whether or not the mic levels are displayed on the recording screen.
[Mic Level Adj.]	Adjust the sound input level to 4 different levels.
[Wind Cut]	This prevents the recording of wind-noise automatically.

[Custom]

Operation of the unit, such as displaying of the screen and button operations, can be set up according to your preferences. Also, it is possible to register the modified settings.

[Cust.Set Mem.]	Registers the current camera settings as custom set.
[Silent Mode]	Disables operational sounds and output of light at once.
[AF/AE Lock]	Sets the fixed content for focusing and exposure when the AF/AE lock is on.

[AF/AE Lock Hold]	This will set the operation of [AF/AE LOCK] button when taking a picture with fixed focus or exposure.
[Shutter AF]	Set whether or not the focus is adjusted automatically when the shutter button is pressed halfway.
[Half Press Release]	The shutter will immediately fire when the shutter button is pressed halfway.
[AFS/AFF/AFC]	Sets the focus method. (P45)
[Quick AF]	Speeds up the focusing that takes place when you press the shutter button.
[Eye Sensor AF]	The camera automatically adjusts the focus when the eye sensor is active.
[Pinpoint AF Time]	Sets the time for which the screen is enlarged when the shutter button is pressed halfway with Auto Focus Mode set to [+] .
[AF Assist Lamp]	AF assist lamp will illuminate the subject when the shutter button is pressed half-way making it easier for the camera to focus when recording in low light conditions.
[Direct Focus Area]	Moves the AF area or MF assist using the cursor button when recording.
[Focus/Release Priority]	It will set so no picture can be taken when it is out of focus.
[AF+MF]	You can set the focus manually after the automatic focus has finished.
[MF Assist]	Sets the display method of MF Assist (enlarged screen).
[MF Guide]	When you set the focus manually, an MF guide that allows you to check the direction to achieve focus is displayed.
[Peaking]	In-focus portions are highlighted when focus is being adjusted manually.
[Histogram]	This allows you to set either to display or not display the histogram.
[Guide Line]	This will set the pattern of guide lines displayed when taking a picture.
[Highlight]	When the Auto Review function is activated or when playing back, white saturated areas appear blinking in black and white.

[Constant Preview]	You can check the effects of the chosen aperture and shutter speed on the recording screen in Manual Exposure Mode.
[Expo.Meter]	Set whether or not to display the exposure meter.
[Dial Guide]	Set whether or not to display the dial operation guide.
[LVF Disp.Style]	This will set the display style of the viewfinder.
[Monitor Disp. Style]	This will set the display style of the monitor.
[Monitor Info. Disp.]	Display the recording information screen.
[Rec Area]	This changes the angle of view during motion picture recording and still picture recording.
[Remaining Disp.]	This will switch display between the number of recordable pictures and available recording time.
[Auto Review]	Set the length of time that the picture is displayed after taking the still picture.
[Fn Button Set]	You can assign frequently-used functions to particular buttons or icons. (P23)
[Q.MENU]	Switch the setting method of Quick Menu. (P22)
[Dial Set.]	Changes the operation methods of the front dial and rear dial.
[Video Button]	Enables/disables the motion picture button.
[Power Zoom Lens]	Sets the screen display and lens operations when using an interchangeable lens that is compatible with power zoom (electrically operated zoom).
[Eye Sensor]	This will set the sensitivity of the eye sensor. This will set whether to automatically switch the display from the Monitor to the Viewfinder when your eye or an object is brought closer to the eye sensor.
[Touch Settings]	Enables/disables the Touch operation.
[Touch Scroll]	This allows you to set the speed of continuously forwarding or rewinding pictures using touch operation.
[Menu Guide]	Set the screen that is displayed when the mode dial is set to  and  .
[Shoot w/o Lens]	Sets whether or not the shutter can be released when no lens is attached to the main body.

[Setup]

This menu lets you perform the clock settings, select the operating beep tone settings and set other settings which make it easier for you to operate the camera.

You can also configure the settings of Wi-Fi related functions.

[Clock Set]	Setting Date/Time.
[World Time]	Sets the times for the region where you live and your holiday destination.
[Travel Date]	Departure date and return date of the trip as well as the name of the travel destination can be set.
[Wi-Fi]	Configure the each setting for Wi-Fi functions.
[Beep]	Set the volume for electronic noises and the electronic shutter noise.
[Speaker Volume]	Adjust the volume of the speaker to any of 7 levels.
[Monitor Display]/ [Viewfinder]	Brightness, color, or red or blue tint of the Monitor/viewfinder is adjusted.
[Monitor Luminance]	Set the monitor brightness to suit the amount of surrounding light.
[Economy]	Suppresses the unit's power consumption to prevent the battery from being run down.
[USB Mode]	Sets the communication method when connecting using the USB connection cable (supplied).
[Output]	This sets how the unit connects to a television etc.
[VIERA Link]	Equipment that supports the VIERA Link will connect automatically.
[3D Playback]	Set the output method for 3D pictures.
[Menu Resume]	Stores the location of the last-used menu item for each menu.
[Menu Background]	Set the background color for the menu screen.
[Menu Information]	Descriptions of menu items or their settings are displayed on the menu screen.

[Language]	Set the language displayed on the screen.
[Version Disp.]	This enables the firmware versions of the camera and lens to be checked.
[Exposure Comp. Reset]	An exposure value can be reset when the recording mode is changed or the camera is turned off.
[Self Timer Auto Off]	Sets whether or not to cancel the self-timer when this unit is turned off.
[No.Reset]	Returns the image file number to 0001.
[Reset]	The recording or setup/custom settings are reset to the default.
[Reset Wi-Fi Settings]	Reset all settings in the [Wi-Fi] menu to factory default settings. (excluding [LUMIX CLUB])
[Pixel Refresh]	It will perform optimization of imaging device and image processing.
[Sensor Cleaning]	Dust reduction to blow off the debris and dust that have affixed to the front of the imaging device is performed.
[Format]	The card is formatted. (P19)

[Playback]

This menu lets you set the Protection, Cropping or Print Settings, etc. of recorded pictures.

[2D/3D Settings]	Switches the playback method for 3D images.
[Slide Show]	Selects the type etc. of the images and plays back in order.
[Playback Mode]	Selects the type etc. of the images and plays back only particular images.
[Location Logging]	The location information (longitude/latitude) acquired by the smartphone/tablet can be sent to the camera and written in images.
[Clear Retouch]	You can erase unnecessary parts recorded on the pictures taken. (P62)
[Title Edit]	Input texts (comments) on the recorded pictures.
[Text Stamp]	Stamps the recorded pictures with recording date and time, names, travel destination, travel date, etc.
[Video Divide]	Splits the recorded motion picture in two.
[Time Lapse Video]	Creates a motion picture from a set of group pictures recorded with the [Time Lapse Shot].
[Stop Motion Video]	Creates a motion picture from the Stop Motion Animation group.
[Resize]	Reduces the image size (number of pixels).
[Cropping]	Crops the recorded image.
[Rotate]	Rotate pictures manually in 90° steps.
[Rotate Disp.]	This mode allows you to display pictures vertically if they were recorded holding the camera vertically.
[Favorite]	Marks can be added to images, and images can be set as favorites.
[Print Set]	Sets the images for printing and the number of prints.
[Protect]	Protects images to prevent deletion by mistake.
[Face Rec Edit]	Removes or changes information relating to personal identity.
[Delete Confirmation]	This sets which option, [Yes] or [No], will be highlighted first when the confirmation screen for deleting a picture is displayed.

Specifications

Specifications are subject to change without notice.

Digital Camera Body (DMC-GX7):

Information for your safety

Power Source:	DC 8.4 V
Power Consumption:	2.5 W (When recording with LCD Monitor) [When the Interchangeable lens (H-H020A) is used] 2.4 W (When recording with LCD Monitor) [When the Interchangeable lens (H-FS1442A) is used] 1.8 W (When playing back with LCD Monitor) [When the Interchangeable lens (H-H020A) is used] 1.7 W (When playing back with LCD Monitor) [When the Interchangeable lens (H-FS1442A) is used]
Camera effective pixels	16,000,000 pixels
Image sensor	4/3" Live MOS sensor, total pixel number 16,840,000 pixels, Primary color filter
Digital Zoom	Max. 4×
Extended Tele Conversion	When taking still pictures: Max. 2× (When a picture size of [S] (4 M), aspect ratio of [4:3] is selected.) When recording motion pictures: 2.4×/3.6×/4.8×
Focus	Auto Focus/Manual Focus, Face Detection/AF Tracking/23-area-focusing/ 1-area-focusing/Pinpoint (Touch focus area selection possible)
Shutter system	Focal-plane shutter

Burst recording	
Burst speed	Mechanical shutter: 5 pictures/second (High speed), 4 pictures/second (Middle speed), 2 pictures/second (Low speed) Electronic shutter: 40 pictures/second (Super high speed), 10 pictures/second (High speed), 4 pictures/second (Middle speed), 2 pictures/second (Low speed)
Number of recordable pictures	Max. 9 pictures (when there are RAW files) Depends on the capacity of the card (when there are no RAW files)
ISO sensitivity (Standard Output Sensitivity)	AUTO/ISO/125*/200/400/800/1600/3200/6400/12800/25600 (1/3 EV step change possible) *Only available when [Extended ISO] is set.
Minimum Illumination	Approx. 5 lx (when i-Low light is used, the shutter speed is 1/30th of a second) [When the Interchangeable lens (H-H020A) is used] Approx. 9 lx (when i-Low light is used, the shutter speed is 1/30th of a second) [When the Interchangeable lens (H-FS1442A) is used]
Shutter speed	B (Bulb) (Max. approx. 120 seconds), 60 seconds to 1/8000th of a second Taking still pictures during motion picture recording: Motion picture priorities: 1/25th of a second to 1/16000th of a second Still picture priorities: B (Bulb) (Max. approx. 120 seconds), 60 seconds to 1/8000th of a second
Metering range	EV 0 to EV 18
White Balance	Auto White Balance/Daylight/Cloudy/Shade/Incandescent lights/Flash/White set1/White set2/White Balance K set
Exposure (AE)	Program AE (P)/Aperture-priority AE (A)/Shutter-priority AE (S)/Manual exposure (M)/AUTO Exposure Compensation (1/3 EV Step, -5 EV to +5 EV)
Metering Mode	Multiple/Center weighted/Spot
Monitor	3.0" TFT LCD (3:2) (Approx. 1,040,000 dots) (field of view ratio about 100%) Touch screen
Viewfinder	Live Viewfinder (16:9) (Approx. 2,760,000 dots equivalent) (field of view ratio about 100%) (with diopter adjustment -4 to +3 diopter)

Flash	<p>Built-in pop up flash GN 7.0 equivalent (ISO200·m) [GN 5.0 equivalent (ISO100·m)] Flash range: Approx. 50 cm (1.6 feet) to 11.7 m (38 feet) [When the Interchangeable lens (H-H020A) is mounted, [ISO AUTO] is set] Flash range: Approx. 50 cm (1.6 feet) to 5.7 m (19 feet) [When the Interchangeable lens (H-FS1442A) is mounted, WIDE, [ISO AUTO] is set] AUTO, AUTO/Red-Eye Reduction, Forced ON, Forced ON/Red-Eye Reduction, Slow Sync., Slow Sync./Red-Eye Reduction, Forced OFF</p>
Flash synchronization speed	<p>Equal to or smaller than 1/320th of a second (When external flashes are used: Equal to or smaller than 1/250th of a second)</p>
Microphone	Stereo
Speaker	Monaural
Recording media	SD Memory Card/SDHC Memory Card*/SDXC Memory Card* (* UHS-I-compatible)
Picture size	
Still picture	<p>When the aspect ratio setting is [4:3] 4592×3448 pixels, 3232×2424 pixels, 2272×1704 pixels When the aspect ratio setting is [3:2] 4592×3064 pixels, 3232×2160 pixels, 2272×1520 pixels When the aspect ratio setting is [16:9] 4592×2584 pixels, 3232×1824 pixels, 1920×1080 pixels When the aspect ratio setting is [1:1] 3424×3424 pixels, 2416×2416 pixels, 1712×1712 pixels</p>

Recording quality	
Motion pictures	[AVCHD] 1920×1080/60p (28 Mbps)/1920×1080/60i (17 Mbps)/ 1920×1080/60i* (24 Mbps)/1920×1080/24p (24 Mbps)/ 1280×720/60p (17 Mbps) (*Sensor output is 30 frames/sec.) [MP4] 1920×1080/60p (28 Mbps)/1920×1080/30p (20 Mbps)/ 1280×720/30p (10 Mbps)/640×480/30p (4 Mbps)
Quality	RAW/RAW+ Fine/RAW+ Standard/Fine/Standard/MPO+ Fine/ MPO+ Standard
Recording file format	
Still Picture	RAW/JPEG (based on "Design rule for Camera File system", based on "Exif 2.3" standard, DPOF corresponding)/MPO
Motion pictures	AVCHD Progressive/AVCHD/MP4
Audio compression	AVCHD Dolby® Digital (2 ch)
	MP4 AAC (2 ch)
Interface	
Digital	"USB 2.0" (High Speed)
Analog video/ audio	NTSC Audio line output (monaural)
Terminal	
[REMOTE]	φ 2.5 mm jack
[AV OUT/DIGITAL]	Dedicated jack (8 pin)
[HDMI]	MiniHDMI Type C

Dimensions	Approx. 122.6 mm (W)×70.7 mm (H)×54.6 mm (D) [4.83" (W)×2.78"(H)×2.15" (D)] (excluding the projecting parts)
Mass (weight)	Approx. 402 g/0.89 lb [with the card and battery] Approx. 360 g/0.79 lb (camera body) Approx. 489 g/1.08 lb [with the Interchangeable lens (H-H020A), card and battery] Approx. 512 g/1.13 lb [with the Interchangeable lens (H-FS1442A), card and battery]
Operating temperature	0 °C to 40 °C (32 °F to 104 °F)
Operating humidity	10%RH to 80%RH
Language select	[ENGLISH]/[ESPAÑOL] (DMC-GX7CP/DMC-GX7KP/DMC-GX7P) [ENGLISH]/[DEUTSCH]/[FRANÇAIS]/[ESPAÑOL]/ [PORTUGUÊS]/[ITALIANO]/[繁體中文]/[日本語] (DMC-GX7CPC/DMC-GX7KPC/DMC-GX7PC)

Wireless transmitter

Compliance standard	IEEE 802.11b/g/n (standard wireless LAN protocol)
Frequency range used (central frequency)	2412 MHz to 2462 MHz (1 to 11ch)
Encryption method	Wi-Fi compliant WPA™/WPA2™
Access method	Infrastructure mode

NFC

Compliance standard	ISO/IEC 18092 NFC-F (Passive Mode)
----------------------------	------------------------------------

Battery Charger (Panasonic DE-A99B):

Information for your safety

Input:	~ 110 V to 240 V, 50/60 Hz, 0.15 A
Output:	=== 8.4 V, 0.43 A

Equipment mobility:

Movable

Battery Pack (lithium-ion) (Panasonic DMW-BLG10PP):

Information for your safety

Voltage/capacity:	7.2 V/1025 mAh
--------------------------	----------------

Interchangeable Lens	H-H020A “LUMIX G 20 mm/F1.7 II ASPH.”	H-FS1442A “LUMIX G VARIO 14–42 mm/F3.5–5.6 II ASPH./MEGA O.I.S.”
Focal length	f=20 mm (35 mm film camera equivalent: 40 mm)	f=14 mm to 42 mm (35 mm film camera equivalent: 28 mm to 84 mm)
Aperture type	7 diaphragm blades/circular aperture diaphragm	7 diaphragm blades/circular aperture diaphragm
Aperture range	F1.7	F3.5 (Wide) to F5.6 (Tele)
Minimum aperture value	F16	F22
Lens construction	7 elements in 5 groups (2 aspherical lenses)	9 elements in 8 groups (2 aspherical lenses)
In focus distance	0.2 m (0.66 feet) to ∞ (from the focus distance reference line)	0.2 m (0.66 feet) to ∞ (from the focus distance reference line) (focal length 14 mm to 20 mm), 0.3 m (0.98 feet) to ∞ (from the focus distance reference line) (focal length 21 mm to 42 mm)
Maximum image magnification	0.13 \times (35 mm film camera equivalent: 0.25 \times)	0.17 \times (35 mm film camera equivalent: 0.34 \times)
Optical Image Stabilizer	Not available	Available
[O.I.S.] switch	None	None (Setting of the [Stabilizer] is done in [Rec] menu.)
Mount	“Micro Four Thirds Mount”	“Micro Four Thirds Mount”
Angle of view	57°	75° (Wide) to 29° (Tele)
Filter diameter	46 mm	46 mm
Max. diameter	Approx. 63 mm (2.48 inch)	Approx. 56 mm (2.21 inch)
Overall length	Approx. 25.5 mm (1.00 inch) (from the tip of the lens to the base side of the lens mount)	Approx. 49 mm (1.93 inch) (from the tip of the lens to the base side of the lens mount)
Mass (weight)	Approx. 87 g/0.19 lb	Approx. 110 g/0.24 lb

Digital Camera Accessory System

Description	Accessory#
Battery Pack	DMW-BLG10
Flash	DMW-FL220, DMW-FL360, DMW-FL360L, DMW-FL500
AC Adaptor* ¹	DMW-AC8
DC Coupler* ¹	DMW-DCC11
Shutter Remote Control	DMW-RSL1
Eye Cup	DMW-EC1
Body Cap	DMW-BDC1
Tripod Adaptor* ²	DMW-TA1
USB connection Cable	DMW-USBC1
AV Cable	DMW-AVC1
Mount Adaptor	DMW-MA1, DMW-MA2M, DMW-MA3R

*1 The AC Adaptor (optional) can only be used with the designated Panasonic DC Coupler (optional). The AC adaptor (optional) cannot be used by itself.

*2 Use if the attached lens is in contact with the tripod pedestal.

Product numbers correct as of August 2013. These may be subject to change.

- Some optional accessories may not be available in some countries.
- NOTE: Accessories and/or model numbers may vary between countries. Consult your local dealer.
- For lens-related optional accessories such as compatible lenses and filters, refer to catalogs/ Web pages, etc.

Digital Camera Accessory Order Form

(For USA and Puerto Rico Customers)

Please photocopy this form when placing an order.

1. Digital Camera Model # _____

2. Items Ordered

Accessory #	Description	Price Each	Quantity	Total Price
Shipping & Handling				\$6.95
Subtotal				
Your State & Local Sales Tax				
Total				

3. Method of payment (check one)

American Express

VISA

Credit Card # _____

MasterCard

Expiration Date _____

Discover

Customer Signature _____

(Please do not send cash)

4. Shipping information (UPS delivery requires complete street address)

Ship To:

Mr.

Mrs.

Ms.

First _____ Last _____

Phone#:

Day () _____

Street Address _____

Night () _____

City _____ State _____ Zip _____

TO OBTAIN ANY OF OUR DIGITAL CAMERA ACCESSORIES YOU CAN DO ANY OF
THE FOLLOWING:

VISIT YOUR LOCAL PANASONIC DEALER

OR

CALL PANASONIC'S ACCESSORY ORDER LINE AT 1-800-332-5368
[6 AM-6 PM M-F, PACIFIC TIME]

OR

MAIL THIS ORDER TO: PANASONIC NATIONAL PARTS CENTER
20421 84th Ave S., Kent, WA 98032

Limited Warranty (ONLY FOR U.S.A. AND PUERTO RICO)

Panasonic Products Limited Warranty

Limited Warranty Coverage (For USA and Puerto Rico Only)

If your product does not work properly because of a defect in materials or workmanship, Panasonic Corporation of North America (referred to as “the warrantor”) will, for the length of the period indicated on the chart below, which starts with the date of original purchase (“warranty period”), at its option either (a) repair your product with new or refurbished parts, (b) replace it with a new or a refurbished equivalent value product, or (c) refund your purchase price. The decision to repair, replace or refund will be made by the warrantor.

Product or Part Name	Parts	Labor
Digital Camera	1 Year	1 Year
All included Accessories (Except Non-Rechargeable Batteries)	90 Days	Not Applicable
Only Non-Rechargeable Batteries	10 Days	Not Applicable

During the “Labor” warranty period there will be no charge for labor. During the “Parts” warranty period, there will be no charge for parts. This Limited Warranty excludes both parts and labor for non-rechargeable batteries, antennas, and cosmetic parts (cabinet). This warranty only applies to products purchased and serviced in the United States or Puerto Rico. This warranty is extended only to the original purchaser of a new product which was not sold “as is”.

Mail-In Service--Online or Telephone Repair Request

Online Repair Request

To submit a new repair request and for quick repair status visit our Web Site at www.panasonic.com/repair.

Telephone Repair Request

You may contact us at: 1-800-211-PANA (7262)

When shipping the unit, carefully pack, include all supplied accessories listed in the Owner's Manual, and send it prepaid, adequately insured and packed well in a carton box. When shipping Lithium Ion batteries please visit our Web Site at www.panasonic.com/BatteryHandling as Panasonic is committed to providing the most up to date information. Include a letter detailing the complaint, a return address and provide a daytime phone number where you can be reached. A valid registered receipt is required under the Limited Warranty.

IF REPAIR IS NEEDED DURING THE WARRANTY PERIOD, THE PURCHASER WILL BE REQUIRED TO FURNISH A SALES RECEIPT/PROOF OF PURCHASE INDICATING DATE OF PURCHASE, AMOUNT PAID AND PLACE OF PURCHASE. CUSTOMER WILL BE CHARGED FOR THE REPAIR OF ANY UNIT RECEIVED WITHOUT SUCH PROOF OF PURCHASE.

Limited Warranty Limits And Exclusions

This warranty ONLY COVERS failures due to defects in materials or workmanship, and DOES NOT COVER normal wear and tear or cosmetic damage. The warranty ALSO DOES NOT COVER damages which occurred in shipment, or failures which are caused by products not supplied by the warrantor, or failures which result from accidents, misuse, abuse, neglect, mishandling, misapplication, alteration, faulty installation, set-up adjustments, misadjustment of consumer controls, improper maintenance, power line surge, lightning damage, modification, introduction of sand, humidity or liquids, commercial use such as hotel, office, restaurant, or other business or rental use of the product, or service by anyone other than a Factory Service Center or other Authorized Servicer, or damage that is attributable to acts of God.

THERE ARE NO EXPRESS WARRANTIES EXCEPT AS LISTED UNDER "LIMITED WARRANTY COVERAGE".

THE WARRANTOR IS NOT LIABLE FOR INCIDENTAL OR CONSEQUENTIAL DAMAGES RESULTING FROM THE USE OF THIS PRODUCT, OR ARISING OUT OF ANY BREACH OF THIS WARRANTY.

(As examples, this excludes damages for lost time, travel to and from the servicer, loss of or damage to media or images, data or other memory or recorded content. The items listed are not exclusive, but for illustration only.)

ALL EXPRESS AND IMPLIED WARRANTIES, INCLUDING THE WARRANTY OF MERCHANTABILITY, ARE LIMITED TO THE PERIOD OF THE LIMITED WARRANTY.

Some states do not allow the exclusion or limitation of incidental or consequential damages, or limitations on how long an implied warranty lasts, so the exclusions may not apply to you. This warranty gives you specific legal rights and you may also have other rights which vary from state to state. If a problem with this product develops during or after the warranty period, you may contact your dealer or Service Center. If the problem is not handled to your satisfaction, then write to the warrantor's Consumer Affairs Department at the addresses listed for the warrantor.

PARTS AND SERVICE, WHICH ARE NOT COVERED BY THIS LIMITED WARRANTY, ARE YOUR RESPONSIBILITY.

Customer Services Directory (United States and Puerto Rico)

Obtain Product Information and Operating Assistance; locate your nearest Dealer or Service Center; purchase Parts and Accessories; or make Customer Service and Literature requests by visiting our Web Site at:

<http://www.panasonic.com/help>

or, contact us via the web at:

<http://www.panasonic.com/contactinfo>

You may also contact us directly at:

1-800-211-PANA (7262)

Monday-Friday 9am-9pm, Saturday-Sunday 10am-7pm EST

For hearing or speech impaired TTY users, TTY: 1-877-833-8855

Accessory Purchases (United States and Puerto Rico)

Purchase Parts, Accessories and Owner's Manual online for all Panasonic Products by visiting our Web Site at:

<http://www.pstc.panasonic.com>

Or, send your request by E-mail to:

npcparts@us.panasonic.com

You may also contact us directly at:

1-800-332-5368 (Phone) 1-800-237-9080 (Fax Only)

(Monday-Friday 9am-9pm EST)

Panasonic National Parts Center

20421 84th Ave S., Kent, WA 98032

(We accept Visa, MasterCard, Discover Card, American Express)

For hearing or speech impaired TTY users, TTY: 1-866-605-1277

As of July 2013

(ENG) VQT5A95 **99**

Limited Warranty (ONLY FOR CANADA)

Panasonic Canada Inc.

5770 Ambler Drive, Mississauga, Ontario L4W 2T3

PANASONIC PRODUCT – LIMITED WARRANTY

Panasonic Canada Inc. warrants this product to be free from defects in material and workmanship under normal use and for a period as stated below from the date of original purchase agrees to, at its option either (a) repair your product with new or refurbished parts, (b) replace it with a new or a refurbished equivalent value product, or (c) refund your purchase price. The decision to repair, replace or refund will be made by Panasonic Canada Inc.

Digital Camera	One (1) year, parts and labour
Digital Camera Peripherals	One (1) year, parts and labour
Digital Camera Accessories	Ninety (90) days, parts and labour

This warranty is given only to the original purchaser, or the person for whom it was purchased as a gift, of a Panasonic brand product mentioned above sold by an authorized Panasonic dealer in Canada and purchased and used in Canada, which product was not sold "as is", and which product was delivered to you in new condition in the original packaging.

IN ORDER TO BE ELIGIBLE TO RECEIVE WARRANTY SERVICE HEREUNDER, A PURCHASE RECEIPT OR OTHER PROOF OF DATE OF ORIGINAL PURCHASE, SHOWING AMOUNT PAID AND PLACE OF PURCHASE IS REQUIRED

LIMITATIONS AND EXCLUSIONS

This warranty **ONLY COVERS** failures due to defects in materials or workmanship, and **DOES NOT COVER** normal wear and tear or cosmetic damage. The warranty **ALSO DOES NOT COVER** damages which occurred in shipment, or failures which are caused by products not supplied by Panasonic Canada Inc., or failures which result from accidents, misuse, abuse, neglect, mishandling, misapplication, alteration, faulty installation, set-up adjustments, misadjustment of consumer controls, improper maintenance, improper batteries, power line surge, lightning damage, modification, introduction of sand, humidity or liquids, commercial use such as hotel, office, restaurant, or other business or rental use of the product, or service by anyone other than a Authorized Servicer, or damage that is attributable to acts of God.

Dry cell batteries, printer ink cartridge and paper are also excluded from coverage under this warranty.

Rechargeable batteries are warranted for ninety (90) days from date of original purchase.

THIS EXPRESS, LIMITED WARRANTY IS IN LIEU OF ALL OTHER WARRANTIES, EXPRESS OR IMPLIED, INCLUDING ANY IMPLIED WARRANTIES OF MERCHANTABILITY AND FITNESS FOR A PARTICULAR PURPOSE. IN NO EVENT WILL PANASONIC CANADA INC. BE LIABLE FOR ANY SPECIAL, INDIRECT OR CONSEQUENTIAL DAMAGES RESULTING FROM THE USE OF THIS PRODUCT OR ARISING OUT OF ANY BREACH OF ANY EXPRESS OR IMPLIED WARRANTY. (As examples, this warranty excludes damages for lost time, travel to and from the Authorized Servicer, loss of or damage to media or images, data or other memory or recorded content. This list of items is not exhaustive, but for illustration only.)

In certain instances, some jurisdictions do not allow the exclusion or limitation of incidental or consequential damages, or the exclusion of implied warranties, so the above limitations and exclusions may not be applicable. This warranty gives you specific legal rights and you may have other rights which vary depending on your province or territory.

WARRANTY SERVICE

For product operation and information assistance, please contact:

Our Customer Care Centre: Telephone: 1-800-99-LUMIX (1-800-995-8649)
Fax # : (905) 238-2360

For defective product exchange within the warranty period, please contact the original Dealer or our Customer Care Centre.

Panasonic Canada Inc. LUMIX Concierge for Camera Owners

Welcome :

As the owner of a Panasonic's LUMIX camera you are entitled to a variety of privileges that will make owning your new LUMIX camera even more of a pleasure. It's our way to provide you with the peace-of-mind you expect from Panasonic.

Panasonic's LUMIX Concierge program adds value to your photography experience with priority services like

- Exclusive Toll-Free telephone access to Dedicated LUMIX experts for assistance and advice
1-800-995-8649

Panasonic Canada Inc. has a team of dedicated experts available to answer any questions you might have regarding your camera.

Should your camera require service we offer priority assistance for repair and return models.

- 48 HR Priority In-Shop service supported by a highly qualified, authorized central repair facility.
- If you have an Over The Counter exchange model, contact the LUMIX Hot line for troubleshooting, then simply return the digital camera to your dealer.

This product incorporates the following software:

- (1) the software developed independently by or for Panasonic Corporation,
- (2) the software owned by third party and licensed to Panasonic Corporation, and/or
- (3) open source software

The software categorized as (3) is distributed in the hope that it will be useful, but WITHOUT ANY WARRANTY, without even the implied warranty of MERCHANTABILITY or FITNESS FOR A PARTICULAR PURPOSE.

Please refer to the detailed terms and conditions thereof displayed by selecting [MENU/SET] → [Setup] → [Version Disp.] → [Software info].

- G MICRO SYSTEM is a lens exchange type digital camera system of LUMIX based on a Micro Four Thirds System standard.
- Micro Four Thirds™ and Micro Four Thirds Logo marks are trademarks or registered trademarks of Olympus Imaging Corporation, in Japan, the United States, the European Union and other countries.
- Four Thirds™ and Four Thirds Logo marks are trademarks or registered trademarks of Olympus Imaging Corporation, in Japan, the United States, the European Union and other countries.
- SDXC Logo is a trademark of SD-3C, LLC.
- "AVCHD", "AVCHD Progressive" and the "AVCHD Progressive" logo are trademarks of Panasonic Corporation and Sony Corporation.
- Manufactured under license from Dolby Laboratories. Dolby and the double-D symbol are trademarks of Dolby Laboratories.
- HDMI, the HDMI Logo, and High-Definition Multimedia Interface are trademarks or registered trademarks of HDMI Licensing LLC in the United States and other countries.
- HDAVI Control™ is a trademark of Panasonic Corporation.
- Adobe is a trademark or registered trademark of Adobe Systems Incorporated in the United States and/or other countries.
- Mac and Mac OS are trademarks of Apple Inc., registered in the U.S. and other countries.
- App Store is a service mark of Apple Inc.

AVCHD™
Progressive



PictBridge

USB LAN WLAN
✓ — ✓

- QuickTime and the QuickTime logo are trademarks or registered trademarks of Apple Inc., used under license therefrom.
- Windows and Windows Vista are either registered trademarks or trademarks of Microsoft Corporation in the United States and/or other countries.
- Android and Google Play are trademarks or registered trademarks of Google Inc.
- The Wi-Fi CERTIFIED Logo is a certification mark of the Wi-Fi Alliance.
- The Wi-Fi Protected Setup Mark is a mark of the Wi-Fi Alliance.
- “Wi-Fi”, “Wi-Fi Protected Setup”, “Wi-Fi Direct”, “WPA” and “WPA2” are marks or registered marks of the Wi-Fi Alliance.
- DLNA, the DLNA Logo and DLNA CERTIFIED are trademarks, service marks, or certification marks of the Digital Living Network Alliance.
- This product uses “DynaFont” from DynaComware Corporation. DynaFont is a registered trademark of DynaComware Taiwan Inc.
- Other names of systems and products mentioned in these instructions are usually the registered trademarks or trademarks of the manufacturers who developed the system or product concerned.



This product is licensed under the AVC patent portfolio license for the personal and non-commercial use of a consumer to (i) encode video in compliance with the AVC Standard (“AVC Video”) and/or (ii) decode AVC Video that was encoded by a consumer engaged in a personal and non-commercial activity and/or was obtained from a video provider licensed to provide AVC Video. No license is granted or shall be implied for any other use. Additional information may be obtained from MPEG LA, LLC. See <http://www.mpegla.com>.

Panasonic Corporation of North America
Two Riverfront Plaza, Newark, NJ 07102-5490

Panasonic Canada Inc.
5770 Ambler Drive, Mississauga, Ontario L4W 2T3

© Panasonic Corporation 2013

Printed in Japan