

Z407 BLUETOOTH® COMPUTER SPEAKERS WITH SUBWOOFER

Setup Guide

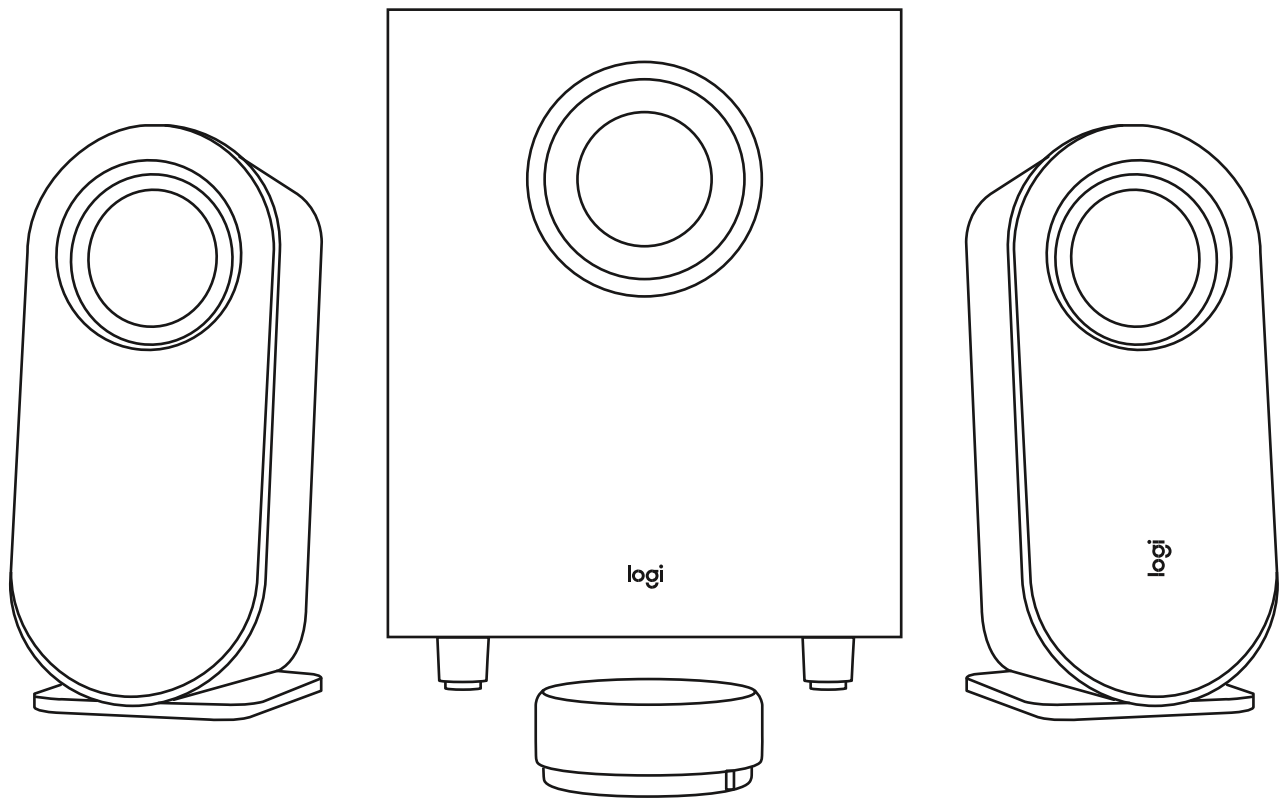

Magyar

115

logitech®

KNOW YOUR PRODUCT

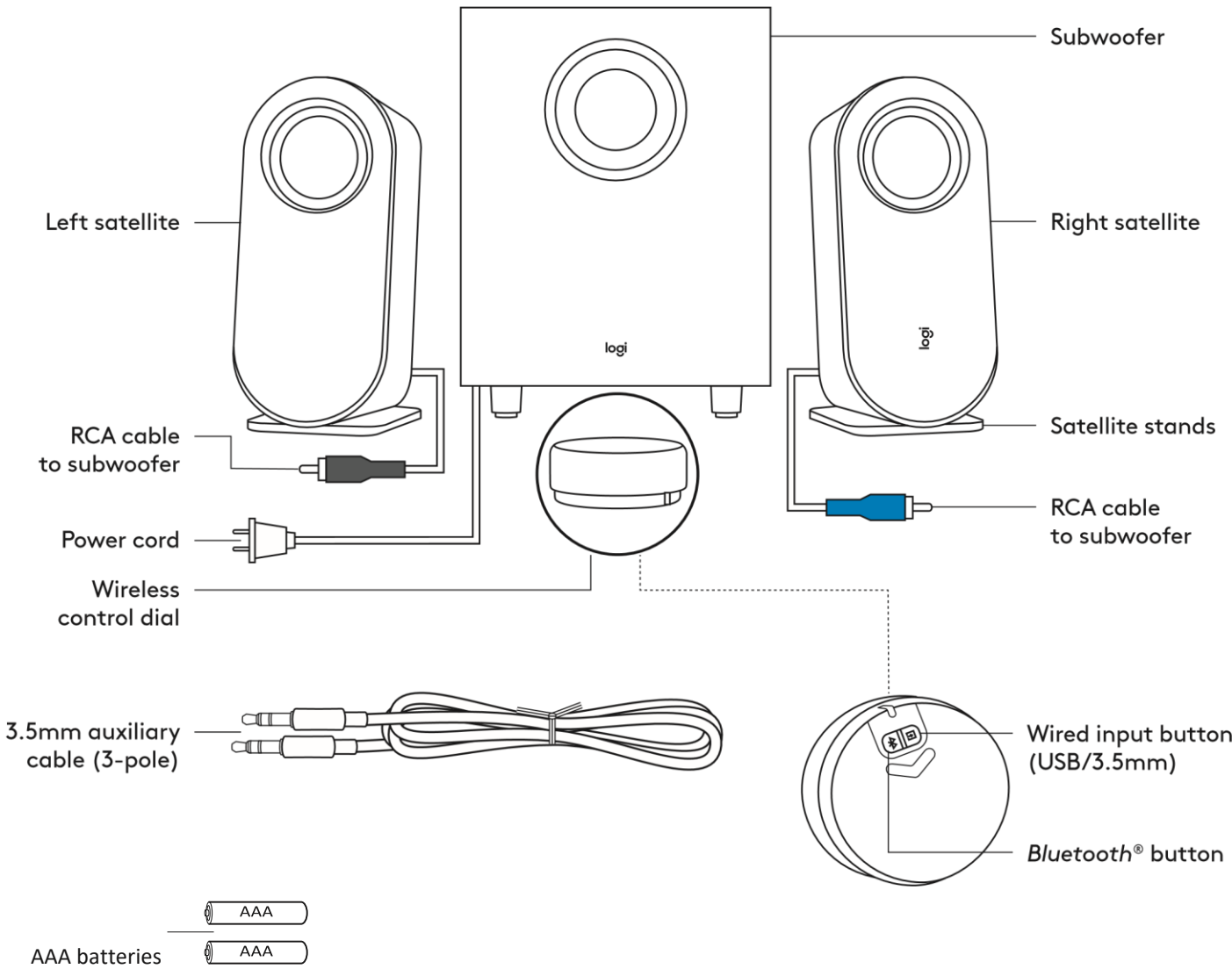

BOX CONTENT

- 1 Left satellite
- 2 Right satellite
- 3 Subwoofer
- 4 Wireless control dial
- 5 2 AAA batteries
- 6 Satellite stands
- 7 3.5 mm cable
- 8 User documentation

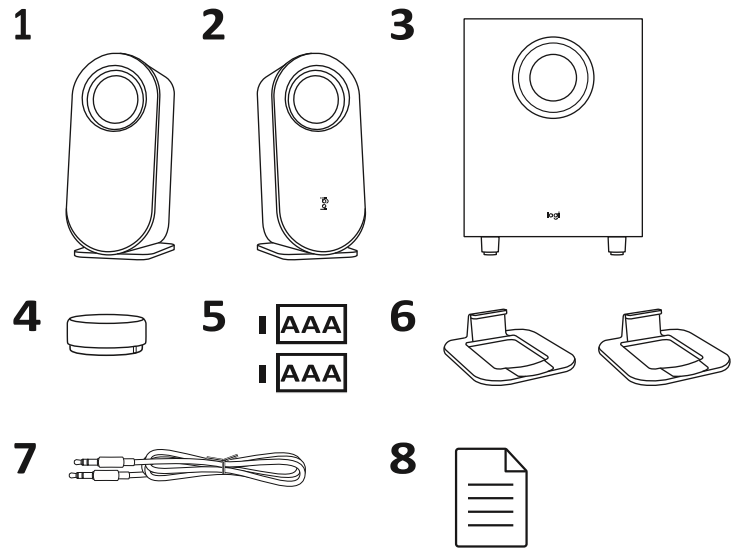

CONNECT THE SPEAKERS

Place the stands to each satellite separately Lay the speakers vertically or horizontally as per your preference Make sure that the stands fit tightly in the speakers

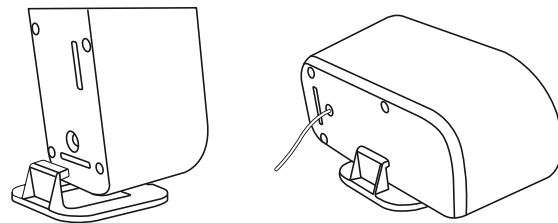

Vertical placement Horizontal placement

- Plug the right satellite cable into the blue subwoofer jack
- Plug the left satellite cable into the gray subwoofer jack

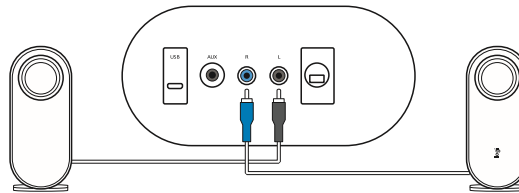

Plug the power cord into an electrical outlet
You will hear a welcome notification sound **CONNECT THE SPEAKERS (CONT'D)**

Long press and push downwards to open the back lid, place two AAA batteries to the corresponding space

*Do not mix using alkaline battery with rechargeable battery.
Do not mix using new and old batteries.
Do not leave the batteries unused in the product for extended periods.*

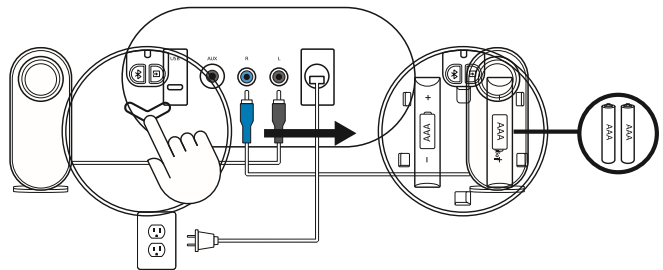

Welcome tone

The LED indicator will then start blinking in blue Once the wireless control dial is successfully connected to the speaker, the LED will turn into a steady blue light

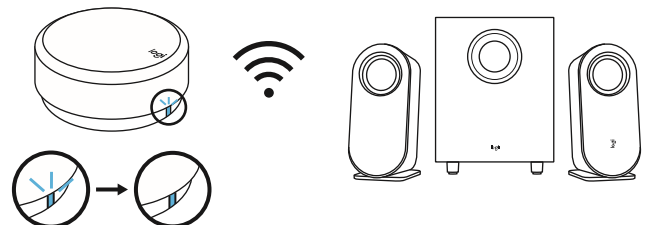

CONNECT TO AUDIO SOURCE

The LED on the control dial will change correspondingly when connected to different connectivity

- The LED will turn blue when connected via *Bluetooth*
- The LED will turn purple when connected via 3.5 mm
- The LED will turn white when connected via USB

CONNECT VIA BLUETOOTH®

Make sure *Bluetooth*® is activated on the source device

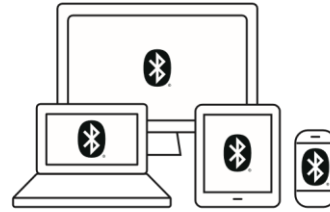

- Press and hold (2sec) the *Bluetooth*® button on the bottom of the dial to activate pairing mode
- The LED indicator will blink quickly. You will start to hear a pairing sound notification

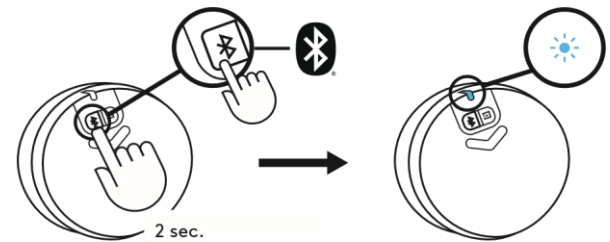

Select and connect to “Logi Z407” on your *Bluetooth*® device list. You will hear a connected tone

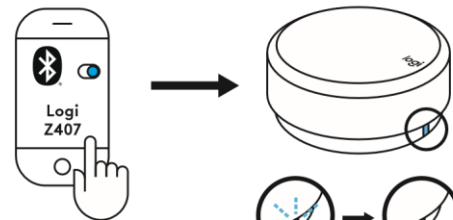

The LED will turn into a steady blue light

CONNECT VIA 3.5MM CABLE

Connect one end of the provided 3.5 mm cable to the auxiliary input on the back of the subwoofer. Then connect the other end of the cable to the 3.5 mm audio jack on your device

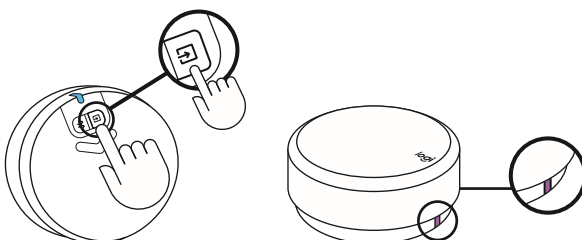
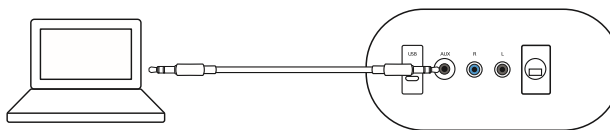

The default connectivity is *Bluetooth*®. To play through 3.5 mm connectivity, press the wired input button on the back of the dial. The LED light will turn purple

CONNECT VIA USB CABLE

Connect one end of the USB cable to the micro USB input on the back of the subwoofer. Then connect the other end of the cable to USB-A input on your device.

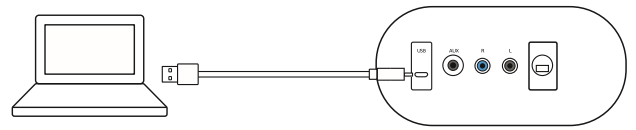

NOTE: USB cable is not included in the box and must be purchased separately.

The default connectivity is *Bluetooth*®. To play through USB connectivity, press the wired input button on the back of the dial. The LED light will turn white.

CONNECT TO THREE DEVICES SIMULTANEOUSLY Connect up to three devices at the same time through the micro USB input, 3.5 mm input on the back of the subwoofer, and *Bluetooth*®.

You can pair up to eight *Bluetooth*® source devices with your speakers.

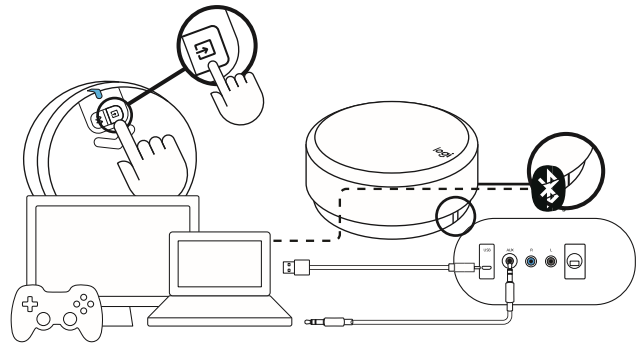

To switch between wired and wireless audio sources, press the *Bluetooth*® button and the wired input button on the back of the wireless control dial.

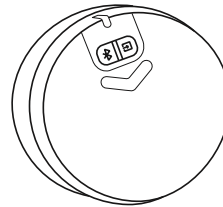

SWITCH BETWEEN DIFFERENT AUDIO SOURCES

SWITCH BETWEEN TWO WIRED CONNECTIVITY

To switch between wired connection (3.5 mm and USB), press the wired input button on the bottom of the dial. The LED color will change correspondingly.

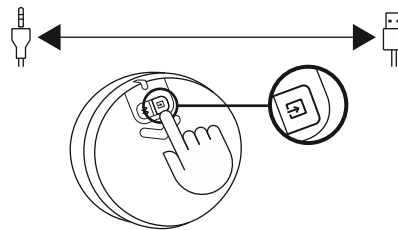

SWITCH BETWEEN WIRED AND WIRELESS CONNECTIVITY

To switch from wired connection to wireless connection (*Bluetooth*®), press the *Bluetooth*® button on the bottom of the dial.

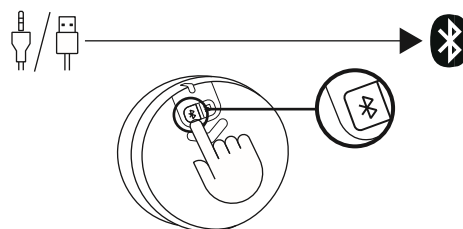

To switch from wireless connection to wired connection, press wired input button on the bottom of the dial

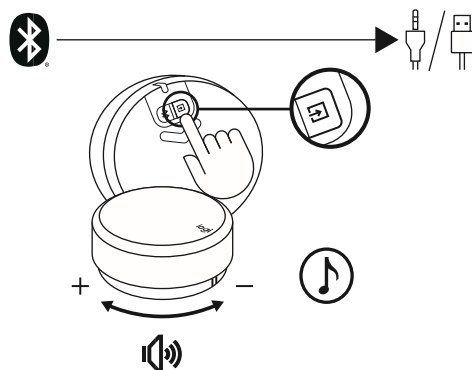

CONTROL YOUR AUDIO CONTENT

ADJUST THE VOLUME

- To adjust the volume of the speaker, rotate the wireless dial control clockwise (counterclockwise) to increase (decrease) the volume
- When reaching to MAX volume, you will hear a notification tone

ADJUST THE BASS

- To adjust the bass level, long press the dial Enter bass for 2 sec and enter bass mode, you will hear a notification sound. Rotate clockwise (counterclockwise) to increase (decrease) Max bass volume (Min bass volume)
- Long press 2 sec to exit bass mode, you will hear an exit notification sound
- If you did not exit bass mode after adjusting the bass, the system will automatically change back to volume mode after 15 seconds without using
- You will hear a notification sound when you reach Max and Min bass level

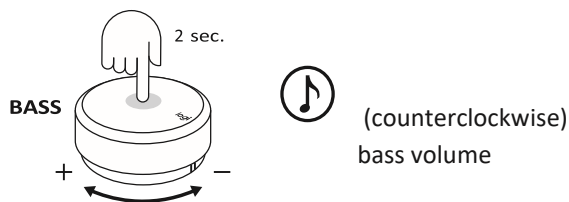

PLAY / PAUSE (MUTE/ UNMUTE)

- Press once on the dial to play / pause (mute/ unmute) your audio content
- Play / pause (Mute/ unmute) will only be activated when the speaker is connected via Bluetooth® or USB input (3.5 mm)

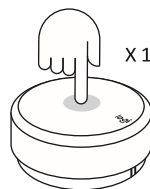

SKIP

- Press twice on the dial to skip your current track
- Skip will only be activated when the speaker is connected via Bluetooth® or USB input

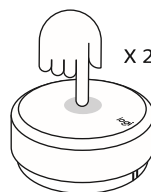

REWIND

- Triple press on the dial to replay the soundtrack
- Rewind will only be activated when the speaker is connected via Bluetooth® or USB input



RESET ALL SETTINGS

Long press the *Bluetooth*[®] button and the wired input button at the same time for 8 sec to reset the system

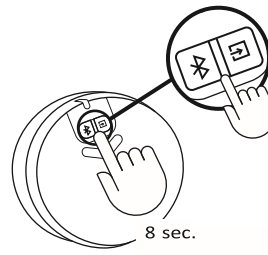

The LED will start to fast blink twice and then you will hear a reset tone. The LED will turn to solid blue after you successfully reset the system. Reset tone

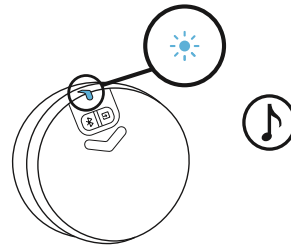

CONTROL DIAL EXPERIENCE

	Usage	Description	LED Status	LED Color	Sonification	Actions	
1	Connection (Dial - Speaker)	Default connected to the speaker	Solid	Blue			
2		Waiting for connection to the speaker	Slow blink	Blue			
3		Dial link lost	Slow blink	White (USB) / Blue (BT) / Purple (AUX)			
4		New dial connects to the speaker	Solid	Blue	V		
5	Connection (Speaker - Device)	Connected / Normal Operation	Solid	White (USB) / Blue (BT) / Purple (AUX)			
6		<i>Bluetooth</i> pairing to device	Fast blinking	Blue	V		Long press <i>Bluetooth</i> button for 2 sec
7		<i>Bluetooth</i> connected	Solid	Blue	V		
8		<i>Bluetooth</i> disconnected	Solid	Blue	V		
9	Media controls	Play / Pause	Solid	White (USB) / Blue (BT)		One press	
10		Mute / Unmute		Purple (AUX)		One press	
11		Track forward		White (USB) / Blue (BT)		Double press	
12		Rewind (Track backward)		White (USB) / Blue (BT)		Triple press	
13	Volume controls	Adjust the system volume	Solid	White (USB) / Blue (BT) / Purple (AUX)		Rotate the dial	
14		Adjust the bass volume					Long press 2 sec to enter and exit bass mode
15		Max volume				V	
16		Max bass				V	
17	System	Low Battery	Solid	Red			
18		Extreme low battery	Fast blink	Red			
19		Reset all settings	Fast blink → Solid	Status color → Blue	V	Press & hold BT and wired input button for 8 sec	

www.logitech.com/support/Z407



