

newair[®]

NCH840BK00

840 Count Compressor Cigar Humidor

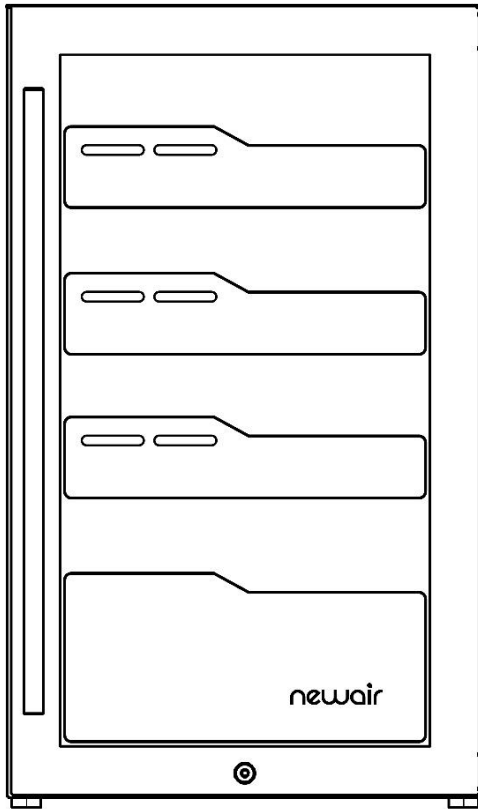

OWNERS MANUAL

Read and save these instructions.



C US
602081

Manual 1.2

READ AND SAVE THESE INSTRUCTIONS.

TABLE OF CONTENTS

Register Your Product Online.....	3
Safety Information & Warnings	4
Parts List	6
Assembly & Installation	7
Operating Instructions	9
Cleaning & Maintenance.....	15
Troubleshooting.....	16
Limited Manufacturer's Warranty	18

SPECIFICATIONS

MODEL No.	NCH840BK00
CAPACITY:	4 Cu. Ft.
VOLTAGE:	120V
CURRENT:	1.4A
FREQUENCY:	60Hz
TEMPERATURE RANGE:	54 - 72°F
NET WEIGHT:	82 lbs.
DIMENSIONS:	19.09" W x 23.62" D x 32.28" H
REFRIGERANT:	R600a
HUMIDITY CONTROL SYSTEM:	Ultrasonic
WATER TANK CAPACITY:	50.7 Fl. Oz.

REGISTER YOUR PRODUCT ONLINE

Register Your NewAir Product Online Today!

Take advantage of all the benefits product registration has to offer:



Service and Support

Diagnose troubleshooting and service issues faster and more accurately



Recall Notifications

Stay up to date for safety, system updates and recall notifications



Special Promotions

Opt-in for NewAir promotions and offers

Registering your product information online is safe & secure and takes less than 2 minutes to complete:

newair.com/register

Alternatively, we recommend you attach a copy of your sales receipt below and record the following information, located on the manufacturer's nameplate on the rear of the unit. You will need this information if it becomes necessary to contact the manufacturer for service inquiries.

Date of Purchase: _____

Serial Number: _____

Model Number: _____

SAFETY INFORMATION & WARNINGS

Before use, please read and follow all safety rules and operating instructions in this manual.



WHEN USING ELECTRICAL APPLIANCES, BASIC SAFETY PRECAUTIONS SHOULD BE FOLLOWED TO REDUCE THE RISK OF FIRE, ELECTRIC SHOCK, AND HARM TO THE USER AND/OR PROPERTY.

- Read all instructions before using this cigar humidor cabinet.
- Never allow children to operate or play with this appliance.
- Never clean appliance parts with flammable fluids. The fumes can create a fire hazard or explosion.
- Do not store or use any flammable vapors and liquids in the vicinity of this appliance. The fumes can create a fire hazard or explosion.
- This appliance is not intended for food storage.
- This appliance is not intended for use by people (including children) with reduced physical, sensory or mental capabilities, lack of experience or knowledge of its operation, unless well instructed or under supervision of a person responsible for their safety.

Risk of child entrapment!



Keep children away from cigar humidors in use. Lock the door to your appliance and warn children not to play inside of it.

Childproof old humidors and other appliances you plan to discard or leave in storage by removing the door completely with a screwdriver.



R600a WARNINGS

For your safety observe the following recommendations:

- This appliance contains a small quantity of R600a refrigerant which is environmentally friendly, but flammable. It does not damage the ozone layer, nor does it increase the greenhouse effect.
- During transportation and installation, ensure that the tubing of the refrigerant circuit is not damaged.
- Avoid using sharp objects near the appliance.
- Leaking refrigerant can ignite.
- In the event any damage does occur, avoid exposure to open fires and any device which creates a spark, disconnect the appliance from the main power, thoroughly ventilate the room in which the appliance is located for several minutes, and notify Customer Service for necessary action and advice.
- The symbol  is a warning and indicates the refrigerant and insulation blowing gas are flammable.
- Do not store explosive substances such as aerosol cans with a flammable propellant in this appliance.
- When positioning the appliance, ensure the supply cord is not trapped or damaged.
- Do not locate multiple portable socket-outlets or portable power supplies at the rear of the appliance.
- The refrigerant and insulation blowing gas are flammable. When disposing of the appliance, do so only at an authorized waste disposal center.



WARNING: It is hazardous for anyone other than an Authorized Service Person to carry out servicing or repairs to this appliance.

- The appliance is designed for freestanding installation only. For freestanding installation, leave 5 inches (127mm) of space around the back and sides of the unit to allow proper air circulation to cool the compressor.
- Do not use mechanical devices or other means to accelerate the defrosting process, other than those recommended by the manufacturer.
- Do not tamper with the refrigerant circuit.
- Do not use extension cords or ungrounded (two prong) adapters.
- If the supply cord is damaged, it must be replaced by the manufacturer, its service agent or a similar qualified person in order to avoid a hazard.

PARTS LIST

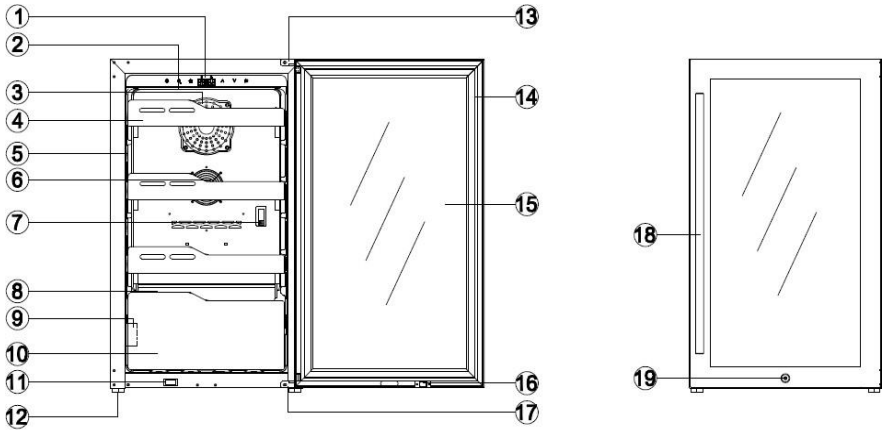

- | | |
|--|----------------------|
| 1. Control Panel | 10. Cigar drawer |
| 2. Top LED light | 11. Magnetic switch |
| 3. Fan motor | 12. Cabinet leg |
| 4. Cigar shelf | 13. Upper door hinge |
| 5. Side LED light | 14. Door seal |
| 6. Fan motor of heater | 15. Glass door |
| 7. Humidity sensor and
Temperature sensor | 16. Magnet |
| 8. Humidifier system | 17. Lower door hinge |
| 9. Adding water box | 18. Handle |
| | 19. Security lock |

ASSEMBLY & INSTALLATION



Allow 24 hours before switching on the cigar humidor. During this time, we recommend that you leave the door open to clear any residual odors.

Important: All models without front venting (air opening) are strictly for freestanding only.

Recommendations:

The location you have selected for your cigar humidor should:

- Be well ventilated
- Be away from any heat source and direct sunlight
- Be in a mostly dry environment (avoid places like laundry rooms, bathrooms, etc.)
- Be on a level surface
- Be connected to a standard and reliable electricity supply. It is NOT recommended to use a multi-socket or extension cord.
- Be connected to a standard 120V electrical outlet.
- Placed away from the microwave oven. Certain microwave ovens do not have a wave interference shield. When placed within 3 feet vicinity of a microwave over, the cigar humidor's operation may be affected.

Grounding instructions:

The cigar humidor must be grounded in case of wire leakage. Grounding reduces the risk of electrical shock. The cigar humidor is equipped with a power cord having a grounding wire and plug. The cigar humidor plug must be plugged into a properly affixed and grounded electrical outlet.

Improper use of the grounding plug can result in the risk of electric shock. Consult a qualified electrician or service person if the grounding instructions are not completely understood.

If the supply cord is damaged, it must be replaced by a qualified person in order to avoid electrical hazard.

INSTALLING YOUR CIGAR HUMIDOR

Unpack and remove all the protection and adhesive strips from the packaging around and inside the cigar humidor.

The cigar humidor must be positioned such that the plug is accessible. The cigar humidor should be installed in a suitable place where the compressor will not be subject to physical contact.

Leveling your cigar humidor: cigar humidor must be leveled BEFORE loading your cigar.

Your cigar humidor is equipped with 4 adjustable feet to facilitate easy leveling. It is recommended that you tighten the back feet to the maximum and adjust the front feet to level the cigar humidor.

OPERATING INSTRUCTIONS

TURNING ON YOUR CIGAR HUMIDOR

Plug in and switch on the appliance by pressing on the power button **for 3 seconds**.

When you use the cigar humidor for the first time (or restart the cigar humidor after having it shut off for a long time), there will be a few degrees variance between the temperature you have selected and the one indicated on the LED readout. This is normal and it is due to the length of the activation time. Once the cigar humidor is running for a few hours everything will stabilize.

IMPORTANT: If the unit is unplugged, power is lost or turned off, wait 3 to 5 minutes before restarting the unit. The cigar humidor will not start if you attempt to restart before this time delay.

Operating Noises

To reach the desired temperature settings, our cigar humidor, like all cigar humidors operating with compressors and fans, may produce the following types of noises. **These noises are normal and may occur as follows:**

- Gurgling sound - caused by the refrigerant flowing through the appliance's coils.
- Cracking/popping sounds - resulting from the contraction and expansion of the refrigerant gas to produce cold.
- Fan operating sound - to circulate the air within the cigar humidor.

CONTROL PANEL INSTRUCTIONS



MODE button:

Press the MODE button to switch the control function from adjusting the temperature to adjusting the humidity.



ON/OFF button:

Press the button ON/OFF button for 3 seconds to turn the unit on. Press the ON/OFF button for 3 seconds to turn the unit off. When you turn off the unit, all other functions will turn off except for the LED light. Press again (without delay) and the power turns on again.



LED LIGHT button:

Press the LED LIGHT button and the light turns on. Press the button again and the light turns off.



TEMPERATURE display window:

Displays internal temperature.



HUMIDITY display window:

Displays internal humidity level.



UP button:

Press the UP button to increase the temperature or humidity by 1 degree Celsius/Fahrenheit or by 1%, depending on which mode the humidifier is set to.



DOWN button:

Press the UP button to decrease the temperature or humidity by 1 degree Celsius/Fahrenheit or by 1%, depending on which mode the humidifier is set to



CELSIUS/FAHRENHEIT button: Change between Celsius and Fahrenheit.

TEMPERATURE SETTINGS

- When you turn on your cigar humidor for the first time, the LED temperature control panel displays the actual internal air temperature by default.
- This cigar humidor comes with a memory function. In the event of a power interruption, all previous temperature settings are automatically reinstated, and it will revert to a preset temperature setting.
- There is a difference between the air temperature inside the cigar humidor and the actual temperature of the cigar: You will need to wait approximately 12 hours before noticing the effects of temperature adjustment due to the critical mass within a full cigar humidor.
- Once the temperature is set, it is strongly advised not to adjust it frequently. The thermostat will maintain the temperature inside the cigar humidor within a +/- 2.5 °F range, but the actual temperature of the cigar will only fluctuate 0.5°F to 1°F.

NOTES:

The cigar humidor temperature control function can keep the best temperature for cigar storage. The recommended range for ideal cigar storage is 60-68 F. Avoid cigar storage at temperature lower than 53 F since that can weaken the cigars causing cigar embrittlement and desiccation. If the temperature is higher 75 F, it will speed up the cigar curing and losing of its taste; increasing chances of tobacco insects infecting the cigars. Avoid putting cigars under the sun or in any closed place with high temperature to dry, instead dry cigars in a dry and cool place.

Your cigar humidor should be installed at a suitable ambient temperature between 61-109F. If the temperature is higher or lower the ambient temperature range, it will create temperature fluctuations and the cigar humidor won't reach its optimal cooling performance.

HUMIDIFICATION SYSTEM

The cigar humididor has an automatic humidification system that is located at the bottom of the cabinet and the water- filling box is in the lower left side of the humididor. Open the plastic cover of the drawer to add water as shown below.

Notes:

Avoid opening or removing any parts of the humidification system without technical assistance.

Avoid filling with unfiltered water since it may cause harm to cigar quality or taste. Check the water-filling box often if you live in an arid climate.

1. Open the plastic cover on the bottom drawer following the direction of the arrow;

2. Pull out the bottom drawer in the direction of the arrow;

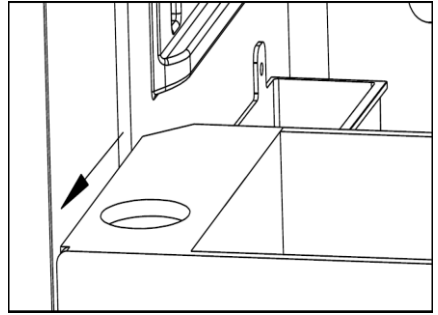
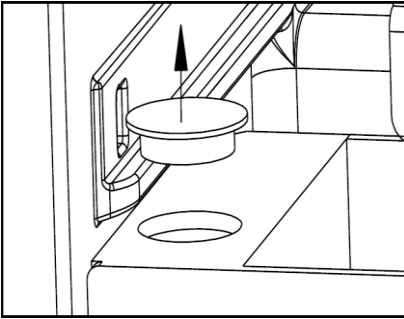

3. Add water in the opening of the bottom drawer

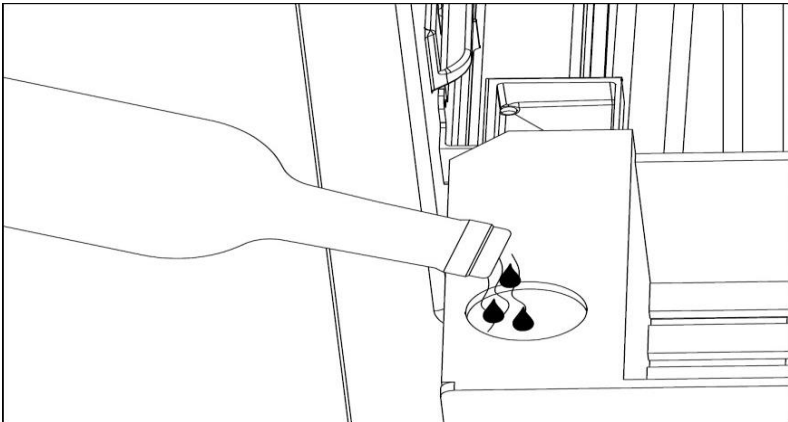

4. Make sure the added water does not exceed the fill line A shown in the figure below.

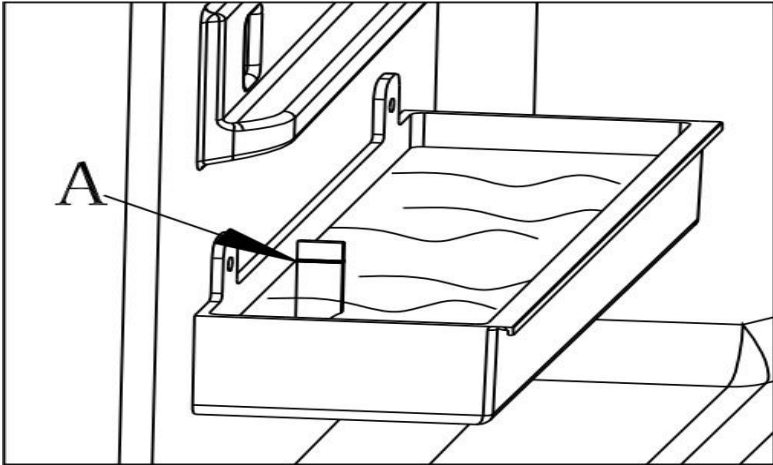

AUTOMATIC DEFROSTING SYSTEM

Your cigar humidor comes with an auto-cycle defrost system. This system will only self-activate if the internal temperature of the humidor falls lower than 53 F for extend periods of time.

If frost build up occurs, the defrost function will melt the frost and collect it in a tray located at the back of the cigar humidor next to the compressor where the compressor's heat will evaporate the water and recycle it into the humidor's humidification system.

This system, when self-activated, helps maintain the humidity level inside your cigar humidor by adding moisture back into the cigar cabinet.

NOTE: This cigar humidor is equipped with a double-glazed glass door that has a third internal acrylic layer to minimize condensation on the glass door.

HOW TO REMOVE THE CEDAR DRAWER

1. Pull the drawer out to reveal the metal latches on either side of the sliding roller rack.
2. Lift the left side of the drawer up and out of the latch. At the same time, move the right side of the drawer down.
3. Pull the drawer off the sliding roller rack and out of the cigar humidor.

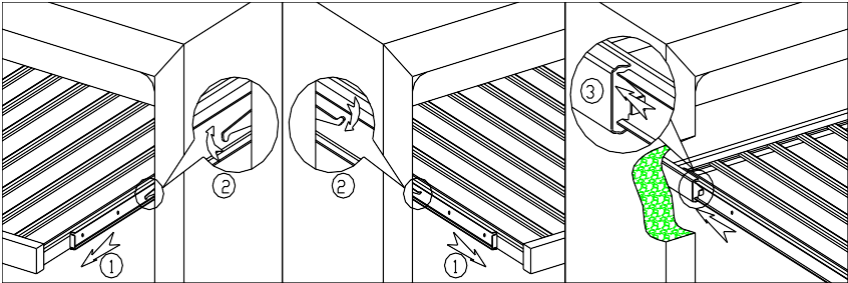

HOW TO INSTALL THE DOOR HANDLE

1. Take out handle from cabinet, then take out 4pcs 4 * 35 screws from accessory bag
2. Pull open door seal from the side of the door, then insert screws into the 2 handle holes on the inside of the door, then put the screws aligned into the hole of handle, tighten the screws with a Phillips screwdriver, then compress the door seal.

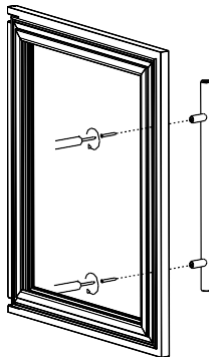

CLEANING & MAINTENANCE

CLEANING YOUR CIGAR CABINET

To clean your cigar cabinet:

- Unplug the cigar humidor and remove its contents and trays.
- Wash the inside with warm water and a baking soda solution. The solution should be about 2 tablespoons of baking soda to a quart of water.
- The outside of the cigar humidor should be cleaned with mild detergent and warm water.
- Remove the water reservoir and wash with mild detergent and warm water.

HOW TO DISPOSE OF YOUR HUMIDOR

1. Disconnect the main plug from the main socket.
2. Cut off the main cable and discard it.

	Correct disposal of this product
	<p>This symbol on the product, or in its packaging, indicates that this product may not be treated as household waste. Instead, it should be taken to the appropriate waste collection point for the recycling of electrical and electronic equipment. By ensuring this product is disposed of correctly, you will help prevent potential negative consequences for the environment and human health, which could otherwise be caused by the inappropriate waste handling of this product. For more detailed information about the recycling of this product, please contact your local council, your household waste disposal service, or the shop where you purchased the product.</p>

TROUBLESHOOTING

OPERATION MALFUNCTIONS

If your cigar humidor appears to be malfunctioning, unplug it and contact our customers service. Any intervention on the cold circuit should be performed by a refrigeration technician who should carry out an inspection of the circuit sealing system. Similarly, any intervention on the electrical circuit should be performed by a qualified electrician.

WARNING: Any intervention performed by a non-authorized technician will lead to the warranty being void.

POWER FAILURES

In the event of a power interruption, all previous temperature settings are automatically reinstated, and it will revert to a preset temperature setting.

Most power failures are corrected within a short period of time. An hour or two loss of power will not affect cigar humidor's temperatures. To avoid sudden change of temperature while the power is off, you should avoid opening the door. For longer periods of power failure, take steps to protect your cigars.

COMMON USAGE PROBLEMS

You can resolve most common usage problems easily by reviewing and following the troubleshooting information below.

Problem	Possible Causes	Solution
The humidor will not operate.	The unit may be plugged in using a different voltage.	Check if using the wrong voltage.
	The circuit breaker may be tripped or there is a blown fuse.	Reset the circuit breaker or check for a broken fuse.
The humidor is not cold enough.	The external environment may require a higher setting.	Lower the temperature of the humidor.
	The door may be opened too frequently.	Open the door less frequently.
	The door is not closed completely.	Make sure the door is closed securely.
	The door seal does not seal properly.	Replace the seal on the door. Replacements can be acquired from the NewAir customer support department.
	The humidor does not have sufficient clearance.	Make sure there is at least 5 inches clearance between the back of the unit and any adjacent walls.
The light does not work.	There may be a problem with the display board.	Contact the NewAir customer support department.

The humidor vibrates while operating.	The unit is not sitting on a level floor, or the unit's feet are not correctly installed.	Make sure the unit's feet are in the proper position and tightened securely.
The humidor produces a lot of noise.	The unit is not leveled.	See above.
	Check the fan.	Check the fan to make sure there is no debris or obstruction. If not, contact the NewAir Customer Support Department
Left window shows HH "High Temperature"	Ambient temperature is too high.	Avoid using at ambient temperature above 108 degrees Farenheit.
	Leakage in refrigeration system or failure of indoor fan.	Contact a qualified technician for repairing.
Left window shows LL "Low Temperature"	Ambient temperature is too low.	Avoid using at ambient temperature below 32 degrees Farenheit.
	Refrigeration system failure.	Contact a qualified technician for repairing.
Right window shows HH "High Humidity"	Appliance is in a high humidity environment and shows higher than set humidity by 15% for more than 48 hrs.	If there is water in the water box it must be drained at this time.
	Refrigeration system failure.	Contact a qualified technician for repairing.
Right window shows LL "Low Humidity"	Humidity is lower than set humidity by 15% for more than 48 hrs. There might be no water in the water box.	Add water to the water box.
	Refrigeration system failure.	Contact a qualified technician for repairing.

LIMITED MANUFACTURER'S WARRANTY

This appliance is covered by a limited manufacturer's warranty. For one year from the original date of purchase, the manufacturer will repair or replace any parts of this appliance that prove to be defective in materials and workmanship, provided the appliance has been used under normal operating conditions as intended by the manufacturer.

Warranty Terms:

During the first year, any components of this appliance found to be defective due to materials or workmanship will be repaired or replaced, at the manufacturer's discretion, at no charge to the original purchaser. The purchaser will be responsible for any removal or transportation costs.

Warranty Exclusions:

The warranty will not apply if damage is caused by any of the following:

- Power failure
- Damage in transit or when moving the appliance
- Improper power supply such as low voltage, defective household wiring or inadequate fuses
- Accident, alteration, misuse or abuse of the appliance such as using non-approved accessories, inadequate air circulation in the room or abnormal operating conditions (extreme temperatures)
- Use in commercial or industrial applications
- Fire, water damage, theft, war, riot, hostility or acts of God such as hurricanes, floods, etc.
- Use of force or damage caused by external influences
- Partially or completely dismantled appliances
- Excess wear and tear by the user

Obtaining Service:

When making a warranty claim, please have the original bill of purchase with purchase date available. Once confirmed that your appliance is eligible for warranty service, all repairs will be performed by a NewAir™ authorized repair facility. The purchaser will be responsible for any removal or transportation costs. Replacement parts and/or units will be new, re-manufactured or refurbished and is subject to the manufacturer's discretion. For technical support and warranty service, please email support@newairusa.com.